















RECMAR®

HIGH QUALITY MARINE PARTS

FOR YAMAHA



ICONOS ICONS

	Medida	Measures
	Peso	Weight
	Material	Material
	Flujo Velocidad	Flow Speed
	Presión	Pressure
	Temperatura	Temperature
	Electricidad	Power
	Unidades x bolsa	Units x bag
	Unidades x skinpack	Units x skinpack
	Tornillo	Screw
	Tubo Manguera	Tube
	Rosca	Thread
	Rosca Macho	Male Thread
	Entrada	IN
	Salida	OUT

	Filtro	Filter
	Elemento filtro	Filter Element
	Junta	Gasket
	Llave	Key
	Posiciones llave	Key positions
	Mando	Control
	Pins	Pins
	Cables Terminales	Terminals
	Cable	Cable
	Piston	Piston
	Aros de piston	Piston ring
	Cojinete	Bearing
	Bulón	Pin
	Biela	Connecting rod
	Clip	Clip

	Impulsor	Impeller
	Dientes	Tooth
	Aguja carburador	Carburetor needle
	Flotador carburador	Carburetor float
	Abrazadera	Clamp
	Volante motor	Flywheel
	Estrias	Spline
	Polea	Pulley
	Solenide Relé	Solenoid Relay
	Motor	Motor

IMPORTANTE

LOS PRODUCTOS QUE APARECEN EN NUESTROS CATALOGOS SON VÁLIDOS Y COMPATIBLES CON LOS MOTORES Y TRANSMISIONES DE LAS MARCAS ORIGINALES QUE APARECEN EN CADA SECCIÓN. ESTA INFORMACIÓN APARECE CON LA REFERENCIA EN EL MOMENTO DE CONFIRMAR EL PEDIDO POR NUESTRA WEB.

LA IMÁGENES AQUÍ CONTENIDAS PUEDEN NO CORRESPONDER CON TOTAL PRECISIÓN AL PRODUCTO SUMINISTRADO. RECAMBIOS MARINOS, S.L.U. SE RESERVA EL DERECHO DE ANULAR O CAMBIAR PRODUCTOS SIN PREVIO AVISO.

IMPORTANT

THE PRODUCTS THAT APPEAR IN OUR CATALOGS ARE VALID AND COMPATIBLE WITH THE MOTORS AND TRANSMISSIONS OF THE ORIGINAL BRANDS THAT APPEAR IN EACH SECTION. THIS INFORMATION APPEARS WITH THE REFERENCE AT THE TIME OF CONFIRMING THE ORDER BY OUR WEB.

IMAGES CONTAINED HERE MAY NOT CORRESPOND WITH TOTAL ACCURACY TO THE PRODUCT SUPPLIED. RECAMBIOS MARINOS, S.L.U. RESERVES THE RIGHT TO CANCEL OR CHANGE PRODUCTS WITHOUT PRIOR NOTICE.

EN

DRIVES MAINTENANCE GUIDE & KITS	848	CONNECTION LINE, POWER	887	THERMOSTAT GASKETS	915
FUEL & FILTRATION SYSTEM	858	PAWL, DRIVE	887	THERMOSTAT GUIDE	915
ACCELERATOR	877	PLATE & DRUM, DRIVE	888	THERMOSTAT, PRESSURE VALVE	916
CARBURATOR	869	STARTER HANDLE ASSY	887	WATER PUMP	922
ACCELEROGRAPH CONTROL	876	STARTER SPRING	887	GUIDE WATER PUMP 4 STROKES	929
BOLT SCREW	875	STARTOR	894	GUIDE WATER PUMP 2 STROKES	931
CARBURETOR GASKES	871	TRIM, TILT & POWER TRIM	895	GUIDE WATER PUMP SERVICE KITS	925
CARBURETOR KITS	872	COMPLETE POWER TRIM ASSEMBLY	898	HOUSING, WATER PUMP	922
ELEMENT FILTER (CARB INLET)	876	COMPLETE TRIM ASSEMBLY	895	WATER PUMP, COVER	923
FLOATS	876	PISTON TRIM PARTS	898	ENGINE PARTS	939
FULL CARBURATOR	869	POWER TRIM SWITCH	895	CRANKSHAFT 4 STROKES	985
GUIDE CARBURATORS	877	TRIM PLUGS	898	GUIDE CRANKSHAFT ASSY	985
KIT 3 CARBURATORS	870	WIRING HARNESS	895	CRANKSHAFT 2 STROKES	1020
NEEDLE VALVE	874	STEERING SYSTEM	899	GUIDE CONNECTING ROAD	1023
PIN FLOAT	875	ARNES	906	GUIDE CRANKSHAFT ASSY	1020
VALVE OF SHEETS	875	BRACKET	909	GUIDE CRANKSHAFT PARTS	1020
FUEL FILTERS AND ELEMENTS	859	BOLT, CLAMP BRACKET	910	GUIDE ENGINE BEARING	1020
FUEL FILTER GUIDE	861	BRACKET OIL SEAL	910	ENGINE GASKET 4 STROKES	983
IN-LINE FUEL FILTER	859	BRACKET ROTARY	910	ENGINE GASKET GUIDE	985
VST FILTER	861	CIRCLIP	910	CYLINDER GASKET	984
FUEL PUMP	858	CONNECTOR	911	CYLINDER HEAD GASKET	983
DIAPHRAGMS & GASKETS	865	LEFT BRACKET ASSY	909	CYLINDER HEAD GASKET KIT	985
FUEL PUMP ELECTRIC	864	OILER M6	910	ENGINE GASKET 2 STROKES	1014
FUEL PUMP MECHANICAL	863	RIGHT BRACKET ASSY	909	ENGINE GASKET GUIDE	1018
FUEL REGULATOR	867	SHELL, MOUNT DAMPER	910	CYLINDER GASKET	1017
VST GASKETS	867	THROTTLE SHAFT CONNECTOR	911	CYLINDER HEAD GASKET	1014
FUEL TANK COMPONENTS & CONNECTORS	858	TILT ROD	910	CYLINDER HEAD GASKET KIT	1015
FILTER	858	BUSHINGS	911	GASKET, HEAD COVER	1019
KNOB OIL SWITCH	859	COMPONENTS 703	908	ENGINE PARTS 4 STROKES	939
OLEOMETER ASSY	859	BLOCK CONTROL HANDLE	909	ENGINE PARTS 2 STROKES	987
PLUG	858	LEVER THROTTLE	909	GUIDE TIMING BELT	1031
PLUG WITH BREATHER	858	LEVER THROTTLE, HANDLE	909	PISTONS 4 STROKES	986
TANK CONNECTOR	858	LINK ROD ASSY	909	PISTON KITS	986
SPRING, PREVENT DESQUAMATING	858	PLATE CONTROL BOX	908	PISTON 2 STROKES	1026
INJEKTOR	868	THROTTLE CABLE	908	GUIDE PISTON & RING	1030
GUIDE INJECTORS & SENDERS	868	THROTTLE HANDLE INCHING	908	PISTON KITS	1026
OIL FILTER	862	ENGINE CONTROLS	899	EXHAUST & INTAKE SYSTEM	1032
OIL FILTER GUIDE	862	CABLE CONNECTOR	902	EXHAUST SYSTEM	1032
ELECTRIC SYSTEM	878	CONSOLE CONTROL	902	EXHAUST GASKETS	1032
CDI & POWER PACK	892	FLUSH MOUNT	901	GASKET, UPPERCASING, OIL PAN, MANIFOLD	1033
COILS	879	PULL TO OPEN	902	INTAKE SYSTEM	1034
COIL LIGHTING	879	PUSH TO OPEN	902	GASKETS INTAKE	1034
CHARGE COIL	882	SIDE CONTROL	899	UNIT DRIVES & COMPONENTS	1037
IGNITION COIL	880	HANDLE GEAR SHIFT ASSY	912	COMPLETE GEARCASE ASSY	1037
PULSER COIL	883	SILENBLOCK	912	4 STROKES GEARCASE	1037
T.C.I. COIL	882	STARTER HANDLE & FIXINGS	912	2 STROKES GEARCASE	1039
CUT OFF SWITCHES	894	STEERING HANDLE ASSY	911	GEAR CASE PARTS 4 STROKES	1040
FLYWHEEL	883	SWITCHES FOR ENGINE CONTROLS	904	GEAR CASE PARTS 2 STROKES	1092
ELECTRIC	883	BUZZER (703)	905	STERN DRIVE BEARING APPLICATION	1137
WITHOUT TOOTH	883	PANEL TWIN STATION	904	STERN DRIVE COMPONENTS GUIDE	1131
IGNITION STARTER SWITCH	888	POWER TRIM SWITCH (703)	904	PROPULSION SYSTEM	1144
CONTROL BOX	888	SWITCH (704)	905	PROPELLER SPARE PARTS	1144
KEY FOR STERN CONTROL	888	WASHER, BELOW	911	OEM --> REF	1145
PUSH T. CHOKE	888	COOLING SYSTEM	914	REF --> OEM	1159
REGULATOR AND RECTIFIERS	890	ANODES	933		
SENSORS	878	ANODES KIT	938		
IAC SENSOR	878	GASKETS KIT	919		
MAP SENSOR	878	IMPELLER GUIDE	921		
TPS SENDER	878	THERMOSTAT	914		
SENSOR, OIL PRESSURE	879	GASKET, EXHAUST INNER COVER	917		
SENSOR, WATER TEMPERATURE	879	NIPPLE	917		
SOLENOID RELAY	888	SPRING	916		
STARTERS	884	THERMOSTAT	914		
		THERMOSTAT COVER	916		

EN

DRIVES MAINTENANCE GUIDE & KITS	848	CONNECTION LINE, POWER	887	THERMOSTAT GASKETS	915
FUEL & FILTRATION SYSTEM	858	PAWL, DRIVE	887	THERMOSTAT GUIDE	915
ACCELERATOR	877	PLATE & DRUM, DRIVE	888	THERMOSTAT, PRESSURE VALVE	916
CARBURATOR	869	STARTER HANDLE ASSY	887	WATER PUMP	922
ACCELEROGRAPH CONTROL	876	STARTER SPRING	887	GUIDE WATER PUMP 4 STROKES	929
BOLT SCREW	875	STARTOR	894	GUIDE WATER PUMP 2 STROKES	931
CARBURETOR GASKES	871	TRIM, TILT & POWER TRIM	895	GUIDE WATER PUMP SERVICE KITS	925
CARBURETOR KITS	872	COMPLETE POWER TRIM ASSEMBLY	898	HOUSING, WATER PUMP	922
ELEMENT FILTER (CARB INLET)	876	COMPLETE TRIM ASSEMBLY	895	WATER PUMP, COVER	923
FLOATS	876	PISTON TRIM PARTS	898		
FULL CARBURATOR	869	POWER TRIM SWITCH	895	ENGINE PARTS	939
GUIDE CARBURETORS	877	TRIM PLUGS	898	CRANKSHAFT 4 STROKES	985
KIT 3 CARBURETORS	870	WIRING HARNESS	895	GUIDE CRANKSHAFT ASSY	985
NEEDLE VALVE	874	STEERING SYSTEM	899	CRANKSHAFT 2 STROKES	1020
PIN FLOAT	875	ARNES	906	GUIDE CONNECTING ROAD	1023
VALVE OF SHEETS	875	BRACKET	909	GUIDE CRANKSHAFT ASSY	1020
FUEL FILTERS AND ELEMENTS	859	BOLT, CLAMP BRACKET	910	GUIDE CRANKSHAFT PARTS	1020
FUEL FILTER GUIDE	861	BRACKET OIL SEAL	910	GUIDE ENGINE BEARING	1020
IN-LINE FUEL FILTER	859	BRACKET ROTARY	910	ENGINE GASKET 4 STROKES	983
VST FILTER	861	CIRCLIP	910	ENGINE GASKET GUIDE	985
FUEL PUMP	858	CONNECTOR	911	CYLINDER GASKET	984
DIAPHRAGMS & GASKETS	865	LEFT BRACKET ASSY	909	CYLINDER HEAD GASKET	983
FUEL PUMP ELECTRIC	864	OILER M6	910	CYLINDER HEAD GASKET KIT	985
FUEL PUMP MECHANICAL	863	RIGHT BRACKET ASSY	909	ENGINE GASKET 2 STROKES	1014
FUEL REGULATOR	867	SHELL, MOUNT DAMPER	910	ENGINE GASKET GUIDE	1018
VST GASKETS	867	THROTTLE SHAFT CONNECTOR	911	CYLINDER GASKET	1017
FUEL TANK COMPONENTS & CONNECTORS	858	TILT ROD	910	CYLINDER HEAD GASKET	1014
FILTER	858	BUSHINGS	911	CYLINDER HEAD GASKET KIT	1015
KNOB OIL SWITCH	859	COMPONENTS 703	908	GASKET, HEAD COVER	1019
OLEOMETER ASSY	859	BLOCK CONTROL HANDLE	909	ENGINE PARTS 4 STROKES	939
PLUG	858	LEVER THROTTLE	909	ENGINE PARTS 2 STROKES	987
PLUG WITH BREATHER	858	LEVER THROTTLE, HANDLE	909	GUIDE TIMING BELT	1031
TANK CONNECTOR	858	LINK ROD ASSY	909	PISTONS 4 STROKES	986
SPRING, PREVENT DESQUAMATING	858	PLATE CONTROL BOX	908	PISTON KITS	986
INJEKTOR	868	THROTTLE CABLE	908	PISTON 2 STROKES	1026
GUIDE INJECTORS & SENDERS	868	THROTTLE HANDLE INCHING	908	GUIDE PISTON & RING	1030
OIL FILTER	862	ENGINE CONTROLS	899	PISTON KITS	1026
OIL FILTER GUIDE	862	CABLE CONNECTOR	902	EXHAUST & INTAKE SYSTEM	1032
		CONSOLE CONTROL	902	EXHAUST SYSTEM	1032
ELECTRIC SYSTEM	878	FLUSH MOUNT	901	EXHAUST GASKETS	1032
CDI & POWER PACK	892	PULL TO OPEN	902	GASKET, UPPERCASING, OIL PAN, MANIFOLD	1033
COILS	879	PUSH TO OPEN	902	INTAKE SYSTEM	1034
COIL LIGHTING	879	SIDE CONTROL	899	GASKETS INTAKE	1034
CHARGE COIL	882	HANDLE GEAR SHIFT ASSY	912		
IGNITION COIL	880	SILENBLOCK	912	UNIT DRIVES & COMPONENTS	1037
PULSER COIL	883	STARTER HANDLE & FIXINGS	912	COMPLETE GEARCASE ASSY	1037
T.C.I. COIL	882	STEERING HANDLE ASSY	911	4 STROKES GEARCASE	1037
CUT OFF SWITCHES	894	SWITCHES FOR ENGINE CONTROLS	904	2 STROKES GEARCASE	1039
FLYWHELL	883	BUZZER (703)	905	GEAR CASE PARTS 4 STROKES	1040
ELECTRIC	883	PANEL TWIN STATION	904	GEAR CASE PARTS 2 STROKES	1092
WITHOUT TOOTH	883	POWER TRIM SWITCH (703)	904	STERN DRIVE BEARING APPLICATION	1137
IGNITION STARTER SWITCH	888	SWITCH (704)	905	STERN DRIVE COMPONENTS GUIDE	1131
CONTROL BOX	888	WASHER, BELOW	911		
KEY FOR STERN CONTROL	888	COOLING SYSTEM	914	PROPULSION SYSTEM	1144
PUSH T. CHOKE	888	ANODES	933	PROPELLER SPARE PARTS	1144
REGULATOR AND RECTIFIERS	890	ANODES KIT	938		
SENSORS	878	GASKETS KIT	919	OEM --> REF	1145
IAC SENSOR	878	IMPELLER GUIDE	921	REF --> OEM	1159
MAP SENSOR	878	THERMOSTAT	914		
TPS SENDER	878	GASKET, EXHAUST INNER COVER	917		
SENSOR, OIL PRESSURE	879	NIPPLE	917		
SENSOR, WATER TEMPERATURE	879	SPRING	916		
SOLENOID RELAY	888	THERMOSTAT	914		
STARTERS	884	THERMOSTAT COVER	916		







YAMAHA

ES

GUÍA MANTENIMIENTO COLAS Y Y KITS	848	SENSOR TPS	878	GUÍA DE IMPULSORES	921
SISTEMA DE ALIMENTACIÓN Y FILTRACIÓN	858	SOLENOIDE RELÉ	888	KITS DE JUNTAS	919
ACELERADOR	877	STARTOR	894	TERMOSTATO	914
BOMBA DE COMBUSTIBLE	858	TRIM, TILT & POWER TRIM	895	CUBIERTAS TERMOSTATO	916
BOMBA DE COMBUSTIBLE ELÉCTRICA	864	DESPIECE PISTÓN TRIM	898	GUÍA TERMOSTATO	915
BOMBA DE COMBUSTIBLE MECÁNICA	863	INSTALACIÓN ELÉCTRICA	895	JUNTAS TAPA DE REFRIGERACIÓN	917
JUNTAS VST	867	INTERRUPTOR POWER TRIM	895	JUNTAS TERMOSTATO	915
MEMBRANAS Y JUNTAS	865	POWER TRIM COMPLETO	898	NIPLE	917
REGULADORES DE PRESIÓN COMBUSTIBLE	867	TRIM COMPLETO BIDIRECCIONAL	895	RESORTE	916
CARBURADOR	869	TAPONES TRIM	898	VÁLVULA ANTIPRESIÓN DE TERMOSTATO	916
AGUJA CARBURADOR	874	VOLANTE DE MOTOR	883	PARTES DEL MOTOR	939
BOYAS	876	ELECTRICO	883	CIGÜEÑAL 4 TIEMPOS	985
CARBURADOR COMPLETO	869	SIN DIENTES (MANUAL)	883	GUÍA CIGÜEÑAL COMPLETO	985
CONECTOR DE CARBURADOR	876	SISTEMA DE GOBIERNO	899	CIGÜEÑAL 2 TIEMPOS	1020
ELEMENTO FILTRO DEL CARBURADOR	876	ARNÉS	906	GUÍA BIELAS	1023
GUÍA CARBURADORES	877	BRACKET	909	GUÍA CIGÜEÑAL COMPLETO	1020
JUNTAS CARBURADORES	871	BRACKET BABOR	909	GUÍA PARTES DE CIGÜEÑAL	1020
KITS CARBURADORES	872	BRACKET ESTRIBOR	909	GUÍA RODAMIENTOS DE MOTOR	1020
KIT 3 CARBURADORES	870	CIRCLIP	910	DESPIECE MOTOR DE 4 TIEMPOS	939
PASADOR DE BOYA	875	CONECTOR	911	DESPIECE MOTOR DE 2 TIEMPOS	987
TORNILLOS	875	EJE CONECTOR ACCELERADOR	911	GUÍA CORREAS DE DISTRIBUCIÓN	1031
VÁLVULA DE LÁMINAS	875	ENGRASADOR INOX 316 M6	910	JUNTAS DE MOTOR 4 TIEMPOS	983
COMPONENTES TANQUE Y CONECTORES	858	SOPORTE BARRA DE DIRECCIÓN	910	JUNTAS BASE DE MOTOR	984
CONECTOR DE DEPÓSITO	858	SOPORTE GIRATORIO	910	JUNTAS DE CULATA	983
LLAVE DE CIERRE DE DEPÓSITO	859	SOPORTE INFERIOR	910	KIT JUNTAS DE CULATA	985
MEDIDOR DE COMBUSTIBLE	859	RETÉN INFERIOR DEL BRACKET	910	GUÍA JUNTAS DE MOTOR	985
RESORTE DE SEGURIDAD PARA TAPÓN	858	VARILLA DE BASCULACIÓN	910	JUNTAS DE MOTOR 2 TIEMPOS	1014
TAPÓN CON RESPIRADERO	858	BUJES	911	JUNTAS BASE DE MOTOR	1017
TAPÓN	858	COLLAR	911	JUNTAS DE CULATA	1014
FILTRO DE ACEITE	862	COMPONENTES 703	908	JUNTAS DE CULATÍN	1019
GUÍA FILTROS DE ACEITE	862	CABLE DE ACCELERADOR	908	GUÍA JUNTAS DE MOTOR	1018
FILTRO DE COMBUSTIBLE Y ELEMENTOS	859	ESPACIADOR	908	KITS JUNTAS DE CULATA	1015
FILTRO COMBUSTIBLE MONTAJE EN LÍNEA	859	MANETA ACCELERADOR	909	PISTONES 4 TIEMPOS	986
GUÍA FILTROS DE COMBUSTIBLE	861	PALANCA ACCELERADOR	908	KITS DE PISTONES	986
FILTRO VST	861	PLACA CERRADURA SELECTOR	909	PISTONES 2 TIEMPOS	1026
INYECTORES	868	RUEDA ACCELERACIÓN	909	GUÍA DE PISTONES Y SEGMENTOS	1030
GUÍA INYECTORES Y SENSORES	868	VARILLA DE ENLACE	909	KIT DE PISTONES	1026
SISTEMA ELÉCTRICO	878	EJE DE CAMBIO	912	SISTEMA DE ESCAPE Y ADMISIÓN	1032
BOBINAS	879	INTERRUPTORES PARA MANDOS	904	SISTEMA DE ADMISIÓN	1034
BOBINA DE CARGA	882	INTERRUPTOR PANEL COMPLETO O DOBLE ESTACIÓN	904	JUNTAS DEL SISTEMA DE ADMISIÓN	1034
BOBINA DE IGNICIÓN	880	INTERRUPTOR PANEL SIMPLE (704)	905	SISTEMA DE ESCAPE	1032
BOBINA DE LUZ	879	INTERRUPTOR POWER TRIM (703)	904	JUNTAS DE COLECTOR Y CARTER	1033
BOBINA DE PULSACIÓN	883	ZUMBADOR ACÚSTICO (703)	905	JUNTAS DE SISTEMA DE ESCAPE	1032
BOBINA DE T.C.I.	882	MANDO ACCELERADOR	911	UNIDADES DE TRANSMISIÓN	1037
CDI Y CAJAS NEGRAS	892	MANETAS Y FIJACIONES	912	COLA COMPLETA	1037
DESCONECTORES DE SEGURIDAD	894	MANDOS DE CONTROL	899	COLAS DE 4 TIEMPOS	1037
LLAVES DE ARRANQUE	888	CONECTORES DE CABLES	902	COLAS DE 2 TIEMPOS	1039
LLAVE CON CHOQUE	888	MANDO LATERAL	899	DESPIECE COLAS 4 TIEMPOS	1040
LLAVE PARA MANDO POPERO	888	MANDO EMPOTRADO	901	DESPIECE COLAS 2 TIEMPOS	1092
MONTAJE EN MANDO DE CONTROL	888	MANDO PARA CONSOLA	902	GUÍA PIEZAS COLA	1131
MOTORES DE ARRANQUE	884	PUSH TO OPEN	902	GUÍA RODAMIENTOS	1037
CABLE DE MOTOR DE ARRANQUE A BATERÍA	887	PULL TO OPEN	902	SISTEMA DE PROPULSIÓN	1144
MUELLE DE ARRANQUE	887	SILENBLOCK	912	GUÍA DE RECAMBIOS DE HÉLICE	1144
PLATO Y PLACA DE ARRANQUE MANUAL	888	SISTEMA DE REFRIGERACIÓN	914	OEM --> REF	1145
TIRADOR DE ARRANQUE	887	ÁNODOS	933	REF --> OEM	1159
TRINQUETE TRACCIÓN PLATO	887	KITS DE ÁNODOS	938		
REGULADORES Y RECTIFICADORES	890	BOMBA DE AGUA	922		
SENSORES	878	CUERPO BOMBA DE AGUA	922		
SENSOR MAP	878	GUÍA BOMBAS DE AGUA 4T	929		
SENSOR PRESIÓN DE ACEITE	879	GUÍA BOMBAS DE AGUA 2T	931		
SENSOR IAC	878	KITS DE REPARACIÓN BOMBA DE AGUA	925		
SENSOR TEMPERATURA DEL AGUA	879	TAPA DE LA BOMBA	923		

YAMAHA

RECMAR®

	KIT	REF					
 F2.5 A (2002-14)	RECKITF2.5A	NGKBR6HS	BUJÍA	SPARK PLUG	1		
		PAF4-04070003	ÁNODO	ANODE	1		
		PAF4-04000011	JUNTA	GASKET	1		
		PAF4-04000006	JUNTA	GASKET	1		
		PAF4-04120005	FILTRO COMBUSTIBLE	FUEL FILTER	1		
		REC90430-08020	JUNTA DESAGÜE	DRAIN GASKET	2		
		REC6L5-45251-03	ÁNODO	ANODE	1		
		PAGB/T91-1.6X12	PIN BLOQUEADOR	COTTER PIN	1		
		PAF2.6-03000013	PIN	PIN	1		
		PAF2.6-03000100	TURBINA	IMPELLER	1		
		PAJASOF404-19-033	TÓRICA	O-RING	1		
		 F2.5 B (2015+)	RECKITF2.5B	NGKCR6HSB	BUJÍA	SPARK PLUG	1
				PAF4-04070003	ANODO	ANODE	1
				PAF4-04000011	JUNTA	GASKET	1
PAF4-04000006	JUNTA			GASKET	1		
PAF4-04120005	FILTRO COMBUSTIBLE			FUEL FILTER	1		
REC90430-08020	JUNTA DESAGÜE			DRAIN GASKET	2		
REC6L5-45251-03	ÁNODO			ANODE	1		
PAGB/T91-1.6X12	PIN BLOQUEADOR			COTTER PIN	1		
PAF2.6-03000013	PIN			PIN	1		
PAF2.6-03000100	TURBINA			IMPELLER	1		
 F4 A (1998-09)	RECKITF4A			NGKBR6HS	BUJÍA	SPARK PLUG	1
				PAF4-04070003	ANODO	ANODE	1
				PAF4-04000011	JUNTA	GASKET	1
				PAF4-03000018	JUNTA	GASKET	1
		PAF4-05000300	FILTRO COMBUSTIBLE	FUEL FILTER	1		
		REC90430-08020	JUNTA DESAGÜE	DRAIN GASKET	2		
		REC6L5-45251-03	ÁNODO	ANODE	1		
		PAGB/T91-1.6X12	PIN BLOQUEADOR	COTTER PIN	1		
		PAF4-03000016	PIN	PIN	1		
		PAF4-03060000	TURBINA	IMPELLER	1		
		PAF4-04000030	MUELLE DEL TUBO DE COMBUSTIBLE	CLAMP	2		
		PAF4-04000006	JUNTA	GASKET	1		
		 F4 B/ F5 A (2010+)	RECKITF5A	NGKCR6HSB	BUJÍA	SPARK PLUG	1
				PAF4-04070003	ANODO	ANODE	1
PAF4-04000011	JUNTA			GASKET	1		
PAF4-03000018	JUNTA			GASKET	1		
REC68T-24251-00	FILTRO COMBUSTIBLE			FUEL FILTER	1		
REC90430-08020	JUNTA DESAGÜE			DRAIN GASKET	2		
REC6L5-45251-03	ÁNODO			ANODE	1		
PAGB/T91-1.6X12	PIN BLOQUEADOR			COTTER PIN	1		
PAF4-03000016	PIN			PIN	1		
PAF4-03060000	TURBINA			IMPELLER	1		
PAF4-04000030	MUELLE DEL TUBO DE COMBUSTIBLE			SPRING, FUEL PIPE	2		
PAF4-04000006	JUNTA			GASKET	1		
 F6 A/B (2000-09) F8 C (2000+) F8F (2015+) F9.9F (2008-12) F9.9J (2013+)	RECKITF6A			NGKBR6HS-10	BUJÍA	SPARK PLUG	2
				PAF4-04070003	ANODO	ANODE	1
		PAJASOF40431-025	TÓRICA	O-RING	1		
		PAGB/T3452.1-13X2	TÓRICA	O-RING	1		
		REC68T-24251-00	FILTRO COMBUSTIBLE	FUEL FILTER	1		
		PAF4-04000030	MUELLE DEL TUBO DE COMBUSTIBLE	SPRING, FUEL PIPE	2		
		REC09168-12017	ARANDELA	WHASER	1		
		REC68T-45251-00AL	ANODO	ANODE	1		
		REC90430-08020	JUNTA DESAGÜE	DRAIN GASKET	1		
		REC91490-30025	PIN BLOQUEADOR	COTTER PIN	1		
		REC68T-W0078-00	KIT BOMBA DE AGUA	WATER PUMP REPAIR KIT	1		
		 F6C (2010+)	RECKITF6C	NGKCR6HSB	BUJÍA	SPARK PLUG	1
				PAF4-04000011	JUNTA	GASKET	1
				PAF4-04070003	ANODO	ANODE	1
REC68T-24251-00	FILTRO COMBUSTIBLE			FUEL FILTER	1		
REC90430-08020	JUNTA DESAGÜE			DRAIN GASKET	2		
REC6L5-45251-02	ANODO			ANODE	1		
PAF4-04000006	JUNTA			GASKET	1		
PAJASOF40431-025	TÓRICA			O-RING	1		
PAF4-03000018	JUNTA			GASKET	1		
PAF4-03060000	TURBINA			IMPELLER	1		
PAF4-03000016	PIN			PIN	1		
PAGB/T91-1.6X12	PIN BLOQUEADOR			COTTER PIN	1		

**KIT**

FT8 D/G (2001-14)
 FT9.9G (2008-12)
 FT9.9J (2013 +)

RECKITFT8D

REF

NGKBR6HS-10	BUJÍA	SPARK PLUG	2
PAF4-04070003	ANODO	ANODE	1
PAJASOF40431-025	TÓRICA	O-RING	1
PAGB/T3452.1-13X2	TÓRICA	O-RING	1
REC68T-24251-00	FILTRO COMBUSTIBLE	FUEL FILTER	1
PAF4-04000030	MUELLE DEL TUBO DE COMBUSTIBLE	SPRING, FUEL PIPE	2
REC09168-12017	ARANDELA	WHASER	1
REC68T-45251-00AL	ANODO	ANODE	1
REC90430-08020	JUNTA DESAGÜE	DRAIN GASKET	2
REC91490-30025	PIN BLOQUEADOR	COTTER PIN	1
REC61N-45251-01AL	ANODO	ANODE	1
REC68T-W0078-00	KIT BOMBA DE AGUA	WATER PUMP REPAIR KIT	1
REC6E0-45251-12AL	ANODO	ANODE	1

F9.9C (1998-08)
 F15A (1998-07)

RECKITF9.9C

REC5GH-13440-00	FILTRO DE ACEITE	OIL FILTER	1
REC66M-11325-00AL	ANODO	ANODE	1
PAF15-07010009	ALOJAMIENTO DEL ÁNODO	SEAL ANODE	1
REC6E5-11325-00AL	ANODO	ANODE	1
PAF15-07010018	JUNTA	GASKET	1
PAJASOF40431-025	TÓRICA	O-RING	1
NGKDPR6EA-9	BUJÍA	SPARK PLUG	2
REC61N-24563-10	FILTRO COMBUSTIBLE	FUEL FILTER	1
PAGB/T3452.1-32.5X1.8	ARANDELA	WHASER	1
PAF15-04000003	ARANDELA	WHASER	1
REC90430-08020	JUNTA DESAGÜE	DRAIN GASKET	2
REC61N-45251-01AL	ANODO	ANODE	1
REC66M-45371-00AL	ANODO	ANODE	1
REC91490-30025	PIN BLOQUEADOR	COTTER PIN	1
REC63V-W0078-01	KIT BOMBA DE AGUA	WATER PUMP REPAIR KIT	1
REC6E0-45251-12AL	ANODO	ANODE	1

F15C (2007+)

RECKITF15C

REC6G8-11325-00AL	ANODO	ANODE	3
PAF20-05000702	JUNTA	GASKET	1
PAGB/T3452.1-13X2	JUNTA	GASKET	1
REC5GH-13440-60	FILTRO DE ACEITE	OIL FILTER	1
PAJASOF40431-025	TÓRICA	O-RING	1
NGKDPR6EB-9	BUJÍA	SPARK PLUG	1
PAF15-07010018	JUNTA	GASKET	1
REC93210-32738	TÓRICA	O-RING	1
REC6E0-45251-12AL	ANODO	ANODE	1
PAF15-04000003	JUNTA	GASKET	1
TEN01154AL	ANODO	ANODE	1
REC91490-30025	PIN BLOQUEADOR	COTTER PIN	1
REC90430-08020	JUNTA DESAGÜE	DRAIN GASKET	2
REC6AH-W0078-00	KIT BOMBA DE AGUA	WATER PUMP REPAIR KIT	1
REC61N-24563-10	FILTRO COMBUSTIBLE	FUEL FILTER	1

F20A (1998-09)

RECKITF20A

REC5GH-13440-00	FILTRO DE ACEITE	OIL FILTER	1
REC62Y-11325-00AL	ANODO	ANODE	2
PAF15-07010009	ALOJAMIENTO DEL ÁNODO	SEAL ANODE	2
PAJASOF40431-025	TÓRICA	O-RING	1
REC40145	FILTRO COMBUSTIBLE	FUEL FILTER	1
PAF4-04000030	MUELLE DEL TUBO DE COMBUSTIBLE	SPRING, FUEL PIPE	2
REC6E0-45251-12AL	ANODO	ANODE	1
PAF15-04000003	ARANDELA	WHASER	1
REC61N-45251-01AL	ANODO	ANODE	1
REC90430-08020	JUNTA DESAGÜE	DRAIN GASKET	2
PAGB/T91-1.6X12	PIN BLOQUEADOR	COTTER PIN	1
NGKDPR6EA-9	BUJÍA	SPARK PLUG	2
REC61N-W0078-11	KIT BOMBA DE AGUA	WATER PUMP REPAIR KIT	1

F20B (2007+)

RECKITF20B

PAF4-04070003	ANODO	ANODE	3
REC6AH-12411-00	TERMOSTATO	THERMOSTAT	1
PAF20-05000702	JUNTA	GASKET	1
REC6E5-11325-00AL	ANODO	ANODE	1
REC5GH-13440-60	FILTRO DE ACEITE	OIL FILTER	1
NGKDPR6EB-9	BUJÍA	SPARK PLUG	2
REC61N-24563-10	FILTRO COMBUSTIBLE	FUEL FILTER	1
REC93210-32738	TÓRICA	O-RING	1
PAF15-04000003	ARANDELA	WHASER	1
REC90430-08020	JUNTA DESAGÜE	DRAIN GASKET	2
TEN01154AL	ANODO	ANODE	1
REC6AH-W0078-00	KIT BOMBA DE AGUA	WATER PUMP REPAIR KIT	1

**KIT**

F25A (1998-09)

RECKITF25A



REF

REC5GH-13440-00	FILTRO DE ACEITE	OIL FILTER	1
PAF15-07000031	TERMOSTATO	THERMOSTAT	1
REC6H3-12414-A1	JUNTA	GASKET	1
REC62Y-11325-00AL	ANODO	ANODE	3
PAF15-07010009	ALOJAMIENTO DEL ÁNODO	SEAL ANODE	2
REC61N-24563-10	FILTRO COMBUSTIBLE	FUEL FILTER	1
REC93210-32738	TÓRICA	O-RING	1
NGKDPR6EA-9	BUJÍA	SPARK PLUG	2
REC6E0-45251-12AL	ANODO	ANODE	1
PAF15-04000003	ARANDELA	WHASER	1
REC61N-45251-01AL	ANODO	ANODE	1
REC90430-08020	JUNTA DESAGÜE	DRAIN GASKET	2
PAGB/T91-1.6X12	PIN BLOQUEADOR	COTTER PIN	1
REC61N-W0078-11	KIT BOMBA DE AGUA	WATER PUMP REPAIR KIT	1

FT25B (2000-09)

RECKITFT25B



REC5GH-13440-00	FILTRO DE ACEITE	OIL FILTER	1
PAF15-07000031	TERMOSTATO	THERMOSTAT	1
REC6H3-12414-A1	JUNTA	GASKET	1
REC62Y-11325-00AL	ANODO	ANODE	3
PAF15-07010009	ALOJAMIENTO DEL ÁNODO	SEAL ANODE	2
REC61N-24563-10	FILTRO COMBUSTIBLE	FUEL FILTER	1
REC93210-32738	TÓRICA	O-RING	1
NGKDPR6EA-9	BUJÍA	SPARK PLUG	2
REC6E0-45251-12AL	ANODO	ANODE	1
PAF15-04000003	ARANDELA	WHASER	1
REC67C-45371-00AL	ANODO	ANODE	1
REC90430-08020	JUNTA DESAGÜE	DRAIN GASKET	2
PAGB/T91-1.6X12	PIN BLOQUEADOR	COTTER PIN	1
REC66T-W0078-00	KIT BOMBA DE AGUA	WATER PUMP REPAIR KIT	1
REC67C-45251-00AL	ANODO	ANODE	1

F25 G (2017+)

RECKITF25G



PAF4-04070003	ANODO	ANODE	4
REC6FM-12411-00	TERMOSTATO	THERMOSTAT	1
REC5GH-13440-60	FILTRO ACEITE	OIL FILTER	1
NGKDPR6EB-9	BUJÍA	SPARK PLUG	2
REC6D8-WS24A-00	FILTRO COMBUSTIBLE	FUEL FILTER	1
PAGB/T3452.1-32.5X1.8	TÓRICA	O-RING	1
PAF4-04000006	ARANDELA	WHASER	1
PAF15-04000003	ARANDELA	WHASER	1
REC6E5-45251-00AL	ANODO	ANODE	1
REC664-45371-01AL	ANODO	ANODE	1
REC90430-08020	JUNTA DESAGÜE	DRAIN GASKET	2
REC6L2-44367-00	GOMA SELLO DE AGUA	DAMPER WATER PIPE	1
REC6L2-44352-00	TURBINA	IMPELLER	1
PAF25-04050003	TÓRICA	O-RING	1
PAGB/T91-1.6X12	PIN BLOQUEADOR	COTTER PIN	1

F25D (2009+)

RECKITF25D



PAF15-07000031	TERMOSTATO	THERMOSTAT	1
REC6H3-12414-A1	JUNTA	GASKET	1
PAF4-04070003	ANODO	ANODE	1
REC5GH-13440-60	FILTRO ACEITE	OIL FILTER	1
REC6BL-11325-00AL	ANODO	ANODE	1
NGKDPR6EB-9	BUJÍA	SPARK PLUG	2
REC61N-24563-10	FILTRO COMBUSTIBLE	FUEL FILTER	1
PAGB/T3452.1-32.5X1.8	TÓRICA	O-RING	1
REC62Y-11325-00AL	ANODO	ANODE	1
PAF15-04000003	ARANDELA	WHASER	1
REC90430-08020	JUNTA DESAGÜE	DRAIN GASKET	2
REC61N-45251-01AL	ANODO	ANODE	1
REC61N-W0078-11	KIT BOMBA DE AGUA	WATER PUMP REPAIR KIT	1
PAGB/T91-1.6X12	PIN BLOQUEADOR	COTTER PIN	1

FT25F (2009+)

RECKITFT25F



PAF15-07000031	TERMOSTATO	THERMOSTAT	1
REC6H3-12414-A1	JUNTA	GASKET	1
PAF4-04070003	ANODO	ANODE	1
REC5GH-13440-60	FILTRO ACEITE	OIL FILTER	1
REC6BL-11325-00AL	ANODO	ANODE	2
NGKDPR6EB-9	BUJÍA	SPARK PLUG	2
REC61N-24563-10	FILTRO COMBUSTIBLE	FUEL FILTER	1
PAGB/T3452.1-32.5X1.8	TÓRICA	O-RING	1
REC6E0-45251-12AL	ANODO	ANODE	1
REC62Y-11325-00AL	ANODO	ANODE	1
PAF15-04000003	ARANDELA	WHASER	1
REC90430-08020	JUNTA DESAGÜE	DRAIN GASKET	2
REC67C-45371-00AL	ANODO	ANODE	1
PAGB/T91-1.6X12	PIN BLOQUEADOR	COTTER PIN	1
REC67C-45251-00AL	ANODO	ANODE	1
REC66T-W0078-00	KIT BOMBA DE AGUA	WATER PUMP REPAIR KIT	1

**KIT**

F30A (2001-09)

RECKITF30A



REF				
PAF15-07000031	TERMOSTATO	THERMOSTAT		1
REC6H3-12414-A1	JUNTA	GASKET		1
NGKDPR6EA-9	BUJÍA	SPARK PLUG		3
REC5GH-13440-00	FILTRO ACEITE	OIL FILTER		1
REC62Y-11325-00AL	ANODO	ANODE		4
PAF15-07010009	ALOJAMIENTO DEL ÁNODO	SEAL ANODE		4
REC40145	FILTRO COMBUSTIBLE	FUEL FILTER		1
PAF4-04000030	MUELLE DEL TUBO DE COMBUTIBLE	SPRING, FUEL PIPE		2
REC688-45251-01AL	ANODO	ANODE		1
PAF15-04000003	ARANDELA	WHASER		1
REC90430-08020	JUNTA DESAGÜE	DRAIN GASKET		2
REC67C-45251-00AL	ANODO	ANODE		1
REC67C-45371-00AL	ANODO	ANODE		1
REC91490-30025	PIN BLOQUEADOR	COTTER PIN		1
REC66T-W0078-00	KIT BOMBA DE AGUA	WATER PUMP REPAIR KIT		1

F30B (2009+)
F40F (2009+)

RECKITF30B



PAF15-07000031	TERMOSTATO	THERMOSTAT		1
REC6H3-12414-A1	JUNTA	GASKET		1
PAF4-04070003	ANODO	ANODE		4
REC5GH-13440-60	FILTRO DE ACEITE	OIL FILTER		1
NGKDPR6EB-9	BUJÍA	SPARK PLUG		3
REC6BG-13915-00	FILTRO COMBUSTIBLE VST	FUEL FILTER VST		1
REC6C5-24251-00	FILTRO COMBUSTIBLE	FUEL FILTER		1
REC6D8-WS24A-00	FILTRO COMBUSTIBLE	FUEL FILTER		1
PAGB/T3452.1-32.5X1.8	TÓRICA	O-RING		1
REC6E0-45251-12AL	ANODO	ANODE		1
REC688-45251-01AL	ANODO	ANODE		1
REC62Y-11325-00AL	ANODO	ANODE		1
PAF15-04000003	ARANDELA	WHASER		1
REC90430-08020	JUNTA DESAGÜE	DRAIN GASKET		2
REC67C-45371-00AL	ANODO	ANODE		1
REC67C-45251-00AL	ANODO	ANODE		1
REC6BG-W0078-00	KIT BOMBA DE AGUA	WATER PUMP REPAIR KIT		1
REC91490-30025	PIN BLOQUEADOR	COTTER PIN		1

F40B (2000-09)

RECKITF40B



PAF15-07000031	TERMOSTATO	THERMOSTAT		1
REC6H3-12414-A1	JUNTA	GASKET		1
REC3FV-13440-00	FILTRO DE ACEITE	OIL FILTER		1
REC62Y-11325-00AL	ANODO	ANODE		3
PAF15-07010009	ALOJAMIENTO DEL ÁNODO	SEAL ANODE		3
NGKDPR6EA-9	BUJÍA	SPARK PLUG		3
REC40145	FILTRO COMBUSTIBLE	FUEL FILTER		1
PAF4-04000030	MUELLE DEL TUBO DE COMBUTIBLE	SPRING, FUEL PIPE		2
REC688-45251-01AL	ANODO	ANODE		1
REC6E0-45251-12AL	ANODO	ANODE		1
PAF15-04000003	ARANDELA	WHASER		1
REC90430-08020	JUNTA DESAGÜE	DRAIN GASKET		2
REC67C-45371-00AL	ANODO	ANODE		1
REC67C-45251-00AL	ANODO	ANODE		1
REC91490-30025	PIN BLOQUEADOR	COTTER PIN		1
REC66T-W0078-00	KIT BOMBA DE AGUA	WATER PUMP REPAIR KIT		1

F50A (1991-07)

RECKITF50A



PAF15-07000031	TERMOSTATO	THERMOSTAT		1
REC6H3-12414-A1	JUNTA	GASKET		1
PAF4-04070003	ANODO	ANODE		4
REC5GH-13440-60	FILTRO DE ACEITE	OIL FILTER		1
NGKDPR6EB-9	BUJÍA	SPARK PLUG		4
REC6BG-13915-00	FILTRO COMBUSTIBLE VST	FUEL FILTER VST		1
REC6C5-24251-00	FILTRO COMBUSTIBLE	FUEL FILTER		1
REC6D8-WS24A-00	FILTRO COMBUSTIBLE	FUEL FILTER		1
PAGB/T3452.1-32.5X1.8	TÓRICA	O-RING		1
REC6E0-45251-12AL	ANODO	ANODE		1
REC688-45251-01AL	ANODO	ANODE		1
REC62Y-11325-00AL	ANODO	ANODE		1
PAF15-04000003	ARANDELA	WHASER		1
REC90430-08020	JUNTA DESAGÜE	DRAIN GASKET		2
REC67C-45371-00AL	ANODO	ANODE		1
REC67C-45251-00AL	ANODO	ANODE		1
REC6BG-W0078-00	KIT BOMBA DE AGUA	WATER PUMP REPAIR KIT		1
REC91490-30025	PIN BLOQUEADOR	COTTER PIN		1



KIT
FT50B (1996-02) RECKITFT50B



REF				
PAF15-07000031	TERMOSTATO	THERMOSTAT		1
REC6H3-12414-A1	JUNTA	GASKET		1
REC5GH-13440-00	FILTRO DE ACEITE	OIL FILTER		1
REC62Y-11325-00AL	ANODO	ANODE		2
PAF15-07010009	ALOJAMIENTO DEL ÁNODO	SEAL ANODE		5
NGKDPR6EA-9	BUJÍA	SPARK PLUG		4
REC68V-24563-00	FILTRO COMBUSTIBLE	FUEL FILTER		1
REC93210-32738	TÓRICA	O-RING		1
REC6E0-45251-12AL	ANODO	ANODE		2
PAF15-04000003	ARANDELA	WHASER		1
REC90430-08020	JUNTA DESAGÜE	DRAIN GASKET		2
REC67F-45371-00AL	ANODO	ANODE		1
REC91490-30025	PIN BLOQUEADOR	COTTER PIN		1
REC6H3-W0078-02	KIT BOMBA DE AGUA	WATER PUMP REPAIR KIT		1

FT50C (2003+) RECKITFT50C



PAF15-07000031	TERMOSTATO	THERMOSTAT		1
REC6H3-12414-A1	JUNTA	GASKET		1
REC62Y-11325-00AL	ANODO	ANODE		5
PAF15-07010009	ALOJAMIENTO DEL ÁNODO	SEAL ANODE		5
NGKDPR6EA-9	BUJÍA	SPARK PLUG		4
REC5GH-13440-00	FILTRO DE ACEITE	OIL FILTER		1
REC61N-24563-10	FILTRO COMBUSTIBLE	FUEL FILTER		1
PAGB/T3452.1-32.5X1.8	TÓRICA	O-RING		1
REC6E0-45251-12AL	ANODO	ANODE		3
PAF15-04000003	ARANDELA	WHASER		1
REC90430-08020	JUNTA DESAGÜE	DRAIN GASKET		2
REC67F-45371-00AL	ANODO	ANODE		1
REC91490-30025	PIN BLOQUEADOR	COTTER PIN		1
REC6H3-W0078-02	KIT BOMBA DE AGUA	WATER PUMP REPAIR KIT		1

F50F (2005-12) RECKITF50F



PAF15-07000031	TERMOSTATO	THERMOSTAT		1
REC6H3-12414-A1	JUNTA	GASKET		1
REC62Y-11325-00AL	ANODO	ANODE		5
PAF15-07010009	ALOJAMIENTO DEL ÁNODO	SEAL ANODE		5
REC5GH-13440-00	FILTRO DE ACEITE	OIL FILTER		1
NGKDPR6EB-9	BUJÍA	SPARK PLUG		1
REC6C5-13915-00	FILTRO COMBUSTIBLE VST	FUEL FILTER VST		1
REC6C5-14984-00	TÓRICA VST	VST O-RING		1
REC6C5-24251-00	FILTRO COMBUSTIBLE	FUEL FILTER		1
REC68V-24563-00	FILTRO COMBUSTIBLE	FUEL FILTER		1
REC93210-32738	TÓRICA	O-RING		1
REC6E0-45251-12AL	ANODO	ANODE		2
REC688-45251-01AL	ANODO	ANODE		1
PAF15-04000003	ARANDELA	WHASER		1
REC90430-08020	JUNTA DESAGÜE	DRAIN GASKET		2
REC67C-45371-00AL	ANODO	ANODE		1
REC67C-45251-00AL	ANODO	ANODE		1
REC91490-30025	PIN BLOQUEADOR	COTTER PIN		1
REC63D-W0078-01	KIT BOMBA DE AGUA	WATER PUMP REPAIR KIT		1

FT50G (2005-12) RECKITFT50G

FT50J (2013+)
FT60D (2005-12)
FT60G (2013+)



PAF15-07000031	TERMOSTATO	THERMOSTAT		1
REC6H3-12414-A1	JUNTA	GASKET		1
REC5GH-13440-60	FILTRO DE ACEITE	OIL FILTER		1
REC62Y-11325-00AL	ANODO	ANODE		1
PAF15-07010009	ALOJAMIENTO DEL ÁNODO	SEAL ANODE		1
NGKDPR6EB-9	BUJÍA	SPARK PLUG		4
PAF4-04070003	ANODO	ANODE		4
PAGB/T3452.1-13X2	TÓRICA	O-RING		4
REC6C5-13915-00	FILTRO COMBUSTIBLE VST	FUEL FILTER VST		1
REC6C5-14984-00	TÓRICA VST	VST O-RING		1
REC6C5-24251-00	FILTRO COMBUSTIBLE	FUEL FILTER		1
REC6D8-WS24A-00	FILTRO COMBUSTIBLE	FUEL FILTER		1
PAGB/T3452.1-32.5X1.8	TÓRICA	O-RING		1
REC6E0-45251-12AL	ANODO	ANODE		3
PAF15-04000003	ARANDELA	WHASER		1
REC90430-08020	JUNTA DESAGÜE	DRAIN GASKET		2
REC67F-45371-00AL	ANODO	ANODE		1
REC91490-30025	PIN BLOQUEADOR	COTTER PIN		1
REC6H3-W0078-02	KIT BOMBA DE AGUA	WATER PUMP REPAIR KIT		1

**KIT**
RECKITF60AF50H (2013+)
F60A (2002-07)
F60C (2005-12)
F60F (2013+)

REF

PAF15-07010009	ALOJAMIENTO DEL ÁNODO	SEAL ANODE	1
REC5GH-13440-60	FILTRO DE ACEITE	OIL FILTER	1
PAF4-04070003	ANODO	ANODE	4
PAGB/T3452.1-13X2	TÓRICA	O-RING	4
NGK DPR6EB-9	BUJÍA	SPARK PLUG	4
REC6C5-13915-00	FILTRO COMBUSTIBLE VST	FUEL FILTER VST	1
REC6C5-14984-00	TÓRICA VST	VST O-RING	1
REC6C5-24251-00	FILTRO COMBUSTIBLE	FUEL FILTER	1
REC6D8-WS24A-00	FILTRO COMBUSTIBLE	FUEL FILTER	1
REC93210-32738	TÓRICA	O-RING	1
REC6E0-45251-12AL	ANODO	ANODE	4
REC688-45251-01AL	ANODO	ANODE	1
PAF15-04000003	ARANDELA	WHASER	1
REC90430-08020	JUNTA DESAGÜE	DRAIN GASKET	2
REC67C-45371-00AL	ANODO	ANODE	1
REC67C-45251-00AL	ANODO	ANODE	1
REC91490-30025	PIN BLOQUEADOR	COTTER PIN	1
REC63D-W0078-01	KIT BOMBA DE AGUA	WATER PUMP REPAIR KIT	1

FT60B (2003-06) **RECKITF60B**

PAF15-07000031	TERMOSTATO	THERMOSTAT	1
REC6H3-12414-A1	JUNTA	GASKET	1
REC62Y-11325-00AL	ANODO	ANODE	5
PAF15-07010009	ALOJAMIENTO DEL ÁNODO	SEAL ANODE	5
REC5GH-13440-60	FILTRO DE ACEITE	OIL FILTER	1
NGK DPR5EA-9	BUJÍA	SPARK PLUG	4
REC61N-24563-10	FILTRO COMBUSTIBLE	FUEL FILTER	1
PAGB/T3452.1-32.5X1.8	TÓRICA	O-RING	1
REC6E0-45251-12AL	ANODO	ANODE	3
PAF15-04000003	ARANDELA	WHASER	1
REC90430-08020	JUNTA DESAGÜE	DRAIN GASKET	2
REC67F-45371-00AL	ANODO	ANODE	1
REC91490-30025	PIN BLOQUEADOR	COTTER PIN	1
REC6H3-W0078-02	KIT BOMBA DE AGUA	WATER PUMP REPAIR KIT	1

F70A (2011+) **RECKITF70A**

PAF15-07000031	TERMOSTATO	THERMOSTAT	1
REC6H3-12414-A1	JUNTA	GASKET	1
REC62Y-11325-00AL	ANODO	ANODE	1
REC5GH-13440-60	FILTRO DE ACEITE	OIL FILTER	1
PAF4-04070003	ANODO	ANODE	3
PAGB/T3452.1-13X2	TÓRICA	O-RING	3
NGK LKR7E	BUJÍA	SPARK PLUG	4
REC6C5-13915-00	FILTRO COMBUSTIBLE VST	FUEL FILTER VST	1
REC6C5-24251-00	FILTRO COMBUSTIBLE	FUEL FILTER	1
REC6D8-WS24A-00	FILTRO COMBUSTIBLE	FUEL FILTER	1
REC93210-32738	TÓRICA	O-RING	1
REC6E0-45251-12AL	ANODO	ANODE	3
PAF15-04000003	ARANDELA	WHASER	1
REC90430-08020	JUNTA DESAGÜE	DRAIN GASKET	2
REC67F-45371-00AL	ANODO	ANODE	1
REC91490-30025	PIN BLOQUEADOR	COTTER PIN	1
REC6CJ-W0078-00	KIT BOMBA DE AGUA	WATER PUMP REPAIR KIT	1

F80A (2000-07) **RECKITF80A**
F100A (1997-07)

REC68V-11325-01AL	ANODO	ANODE	2
REC5GH-13440-00	FILTRO DE ACEITE	OIL FILTER	1
REC67F-12411-01	TERMOSTATO	THERMOSTAT	1
NGK LFR5A-11	BUJÍA	SPARK PLUG	4
PAJASOF40431-025	TÓRICA	O-RING	1
REC61N-24563-10	FILTRO COMBUSTIBLE	FUEL FILTER	1
PAGB/T3452.1-32.5X1.8	TÓRICA	O-RING	1
REC6H1-45251-03AL	ANODO	ANODE	1
PAF15-04000003	ARANDELA	WHASER	1
REC91490-30025	PIN BLOQUEADOR	COTTER PIN	1
REC90430-08020	JUNTA DESAGÜE	DRAIN GASKET	2
REC67F-W0078-00	KIT BOMBA DE AGUA	WATER PUMP REPAIR KIT	1



F80B (2005+)

KIT
RECKITF80B

REF

REC6E5-11325-00AL	ANODO	ANODE	3
REC67F-11325-01AL	ANODO	ANODE	3
REC5GH-13440-00	FILTRO DE ACEITE	OIL FILTER	1
PAJASOF40431-025	TÓRICA	O-RING	1
REC67F-12411-01	TERMOSTATO	THERMOSTAT	1
NGKLF5A-11	BUJÍA	SPARK PLUG	4
REC6C5-13915-00	FILTRO COMBUSTIBLE	FUEL FILTER	1
REC6C5-24251-00	FILTRO COMBUSTIBLE	FUEL FILTER	1
REC6D8-WS24A-00	FILTRO COMBUSTIBLE	FUEL FILTER	1
PAGB/T3452.1-32.5X1.8	TÓRICA	O-RING	1
REC6H1-45251-03AL	ANODO	ANODE	1
PAF15-04000003	ARANDELA	WHASER	1
REC90430-08020	JUNTA DESAGÜE	DRAIN GASKET	2
REC67F-45371-00	ANODO	ANODE	1
REC91490-30025	PIN BLOQUEADOR	COTTER PIN	1
REC67F-W0078-00	KIT BOMBA DE AGUA	WATER PUMP REPAIR KIT	1

F100D (2005+)

RECKITF100D



REC6E5-11325-00AL	ANODO	ANODE	3
REC5GH-13440-00	FILTRO DE ACEITE	OIL FILTER	1
REC67F-11325-01AL	ANODO	ANODE	3
PAJASOF40431-025	TÓRICA	O-RING	1
REC6D9-12411-00	TERMOSTATO	THERMOSTAT	1
NGKLF5A-11	BUJÍA	SPARK PLUG	4
REC6C5-13915-00	FILTRO COMBUSTIBLE	FUEL FILTER	1
REC6C5-24251-00	FILTRO COMBUSTIBLE	FUEL FILTER	1
REC6D8-WS24A-00	FILTRO COMBUSTIBLE	FUEL FILTER	1
PAGB/T3452.1-32.5X1.8	TÓRICA	O-RING	1
REC6H1-45251-03AL	ANODO	ANODE	1
PAF15-04000003	ARANDELA	WHASER	1
REC90430-08020	JUNTA DESAGÜE	DRAIN GASKET	2
REC67F-45371-00	ANODO	ANODE	1
REC91490-30025	PIN BLOQUEADOR	COTTER PIN	1
REC67F-W0078-00	KIT BOMBA DE AGUA	WATER PUMP REPAIR KIT	1

F100F (2017+)

RECKITF100F



PAF4-04070003	ANODO	ANODE	4
PAGB/T3452.1-13X2	TÓRICA	O-RING	4
REC63P-11325-01AL	ANODO	ANODE	1
REC5GH-13440-00	FILTRO DE ACEITE	OIL FILTER	1
REC6FP-12411-00	TERMOSTATO	THERMOSTAT	1
NGKLR6E-9N	BUJÍA	SPARK PLUG	4
REC63P-11325-21	ANODO	ANODE	1
REC6C5-24251-00	FILTRO COMBUSTIBLE	FUEL FILTER	1
REC6D8-WS24A-00	FILTRO COMBUSTIBLE	FUEL FILTER	1
PAGB/T3452.1-32.5X1.8	TÓRICA	O-RING	1
REC6H1-45251-03AL	ANODO	ANODE	1
PAF15-04000003	ARANDELA	WHASER	1
REC90430-08020	JUNTA DESAGÜE	DRAIN GASKET	2
REC6E5-45371-01AL	ANODO	ANODE	1
REC91490-30025	PIN BLOQUEADOR	COTTER PIN	1
REC68V-W0078-00	KIT BOMBA DE AGUA	WATER PUMP REPAIR KIT	1

F115A (2000-15)

RECKITF115A



REC6E5-11325-00AL	ANODO	ANODE	3
REC5GH-13440-00	FILTRO DE ACEITE	OIL FILTER	1
REC67F-11325-01AL	ANODO	ANODE	3
REC60V-12411-00	TERMOSTATO	THERMOSTAT	1
NGKLF6A-11	BUJÍA	SPARK PLUG	4
REC6CB-24501-01	FILTRO COMBUSTIBLE	FUEL FILTER	1
REC6CB-13016-00	TÓRICA	O-RING	1
REC63P-13915-00	FILTRO COMBUSTIBLE	FUEL FILTER	1
REC6CB-14984-00	TÓRICA	O-RING	1
REC6G5-45251-02AL	ANODO	ANODE	1
REC6D8-WS24A-00	FILTRO COMBUSTIBLE	FUEL FILTER	1
PAGB/T3452.1-32.5X1.8	TÓRICA	O-RING	1
PAF15-04000003	ARANDELA	WHASER	1
REC90430-08020	JUNTA DESAGÜE	DRAIN GASKET	2
REC6E5-45371-01AL	ANODO	ANODE	1
REC91490-30025	PIN BLOQUEADOR	COTTER PIN	1
REC68V-W0078-00	KIT BOMBA DE AGUA	WATER PUMP REPAIR KIT	1

**KIT**F115B (2014+)
F130A (2015+)**RECKITF115B**

REF

PAF4-04070003	ANODO	ANODE	3
PAGB/T3452.1-13X2	TÓRICA	O-RING	3
REC63P-11325-01AL	ANODO	ANODE	1
REC5GH-13440-00	FILTRO DE ACEITE	OIL FILTER	1
REC67F-11325-01AL	ANODO	ANODE	1
NGKLR6E	BUJÍA	SPARK PLUG	4
REC6CB-13016-00	TÓRICA	O-RING	1
REC63P-13915-00	FILTRO COMBUSTIBLE	FUEL FILTER	1
REC6CB-14984-00	TÓRICA	O-RING	1
REC6D8-WS24A-00	FILTRO COMBUSTIBLE	FUEL FILTER	1
PAGB/T3452.1-32.5X1.8	TÓRICA	O-RING	1
REC6H1-45251-03AL	ANODO	ANODE	1
PAF15-04000003	ARANDELA	WHASER	1
REC90430-08020	JUNTA DESAGÜE	DRAIN GASKET	2
REC6E5-45371-01AL	ANODO	ANODE	1
REC91490-30025	PIN BLOQUEADOR	COTTER PIN	1
REC68V-W0078-00	KIT BOMBA DE AGUA	WATER PUMP REPAIR KIT	1

F150A (2003+)
F150B (2012+)
F150D (2015+)
F150F (2015+)
REGULAR ROTATION**RECKITF150RR**

REC63P-11325-11AL	ANODO	ANODE	4
REC63P-11325-01AL	ANODO	ANODE	1
REC67F-11325-01AL	ANODO	ANODE	3
NGKLR5A-11	BUJÍA	SPARK PLUG	4
REC68T-11325-00AL	ANODO	ANODE	8
REC67F-12411-01	TERMOSTATO	THERMOSTAT	1
REC63P-12414-00	JUNTA	GASKET	1
REC35-822626Q15	FILTRO DE ACEITE	OIL FILTER	1
REC63P-14984-00	TÓRICA VST	VST O-RING	1
REC63P-13915-00	FILTRO COMBUSTIBLE	FUEL FILTER	1
REC65L-24563-00	FILTRO COMBUSTIBLE	FUEL FILTER	1
REC69J-24501-10	FILTRO COMBUSTIBLE	FUEL FILTER	1
REC6P3-WS24A-00	FILTRO COMBUSTIBLE	FUEL FILTER	1
REC6P3-24564-00	TÓRICA	O-RING	1
PAF15-04000003	ARANDELA	WHASER	1
REC90430-08020	JUNTA DESAGÜE	DRAIN GASKET	2
REC61A-W0078-A1	KIT BOMBA DE AGUA	WATER PUMP REPAIR KIT	1
REC91490-30025	PIN BLOQUEADOR	COTTER PIN	1
RECKITY150-200AL	KIT ÁNODOS	KIT ANODES	1

F150A (2003+)
F150B (2012+)
F150D (2015+)
F150F (2015+)
COUNTER ROTATION**RECKITF150CR**

REC63P-11325-21	ANODO	ANODE	1
REC63P-11325-11A	ANODO	ANODE	4
REC63P-11325-01AL	ANODO	ANODE	1
REC67F-11325-01AL	ANODO	ANODE	3
NGKLR5A-11	BUJÍA	SPARK PLUG	4
REC68T-11325-00A	ANODO	ANODE	8
REC67F-12411-01	TERMOSTATO	THERMOSTAT	1
REC63P-12414-00	JUNTA	GASKET	1
REC35-822626Q15	FILTRO DE ACEITE	OIL FILTER	1
REC63P-14984-00	TÓRICA VST	VST O-RING	1
REC63P-13915-00	FILTRO COMBUSTIBLE	FUEL FILTER	1
REC65L-24563-00	FILTRO COMBUSTIBLE	FUEL FILTER	1
REC69J-24501-10	FILTRO COMBUSTIBLE	FUEL FILTER	1
REC6P3-WS24A-00	FILTRO COMBUSTIBLE	FUEL FILTER	1
REC6P3-24564-00	TÓRICA	O-RING	1
PAF15-04000003	ARANDELA	WHASER	1
REC90430-08020	JUNTA DESAGÜE	DRAIN GASKET	2
REC61A-W0078-A1	KIT BOMBA DE AGUA	WATER PUMP REPAIR KIT	1
REC91490-30025	PIN BLOQUEADOR	COTTER PIN	1
RECKITY150-200CRAL	KIT ÁNODOS	KIT ANODES	1

**KIT**
RECKITF150GF150G (2017+)
F175A (2014+)
F175C (2017+)
F200F (2013+)
F200G (2013+)

REF

REC67F-11325-01AL	ANODO	ANODE	3
REC6E5-11325-00AL	ANODO	ANODE	2
REC68T-11325-00AL	ANODO	ANODE	2
REC6DA-12411-01	TERMOSTATO	THERMOSTAT	1
PAF15-04000003	ARANDELA	WHASER	1
REC35-822626Q15	FILTRO DE ACEITE	OIL FILTER	1
REC6CB-24501-01	FILTRO COMBUSTIBLE	FUEL FILTER	1
REC6CB-13016-00	TÓRICA	O-RING	1
REC63P-13915-00	FILTRO COMBUSTIBLE	FUEL FILTER	1
REC6CB-14984-00	TÓRICA	O-RING	1
REC6P3-WS24A-00	FILTRO COMBUSTIBLE	FUEL FILTER	1
REC6P3-24564-00	TÓRICA	O-RING	1
REC6AW-45251-00AL	ANODO	ANODE	1
REC90430-08020	JUNTA DESAGÜE	DRAIN GASKET	2
REC6J9-45371-01AL	ANODO	ANODE	1
NGKLF6A-11	BUJÍA	SPARK PLUG	4
REC61A-W0078-A1	KIT BOMBA DE AGUA	WATER PUMP REPAIR KIT	1
REC91490-30025	PIN BLOQUEADOR	COTTER PIN	1
REC6K1-45371-02AL	ANODO	ANODE	1

F200A (2002-07)
F225A (2002-07)**RECKITF200A**

REC67F-12411-01	TERMOSTATO	THERMOSTAT	2
REC35-822626Q15	FILTRO DE ACEITE	OIL FILTER	1
REC6E5-11325-00AL	ANODO	ANODE	4
REC68V-11325-01	ANODO	ANODE	2
NGKLF6A-11	BUJÍA	SPARK PLUG	2
REC67F-11325-01AL	ÁNODO	ANODE	4
REC65L-24563-00	FILTRO COMBUSTIBLE	FUEL FILTER	1
REC68V-14984-00	TÓRICA VST	VST O-RING	1
REC68V-13915-00	FILTRO COMBUSTIBLE	FUEL FILTER	1
REC69J-24501-10	FILTRO COMBUSTIBLE	FUEL FILTER	1
REC6P3-WS24A-00	FILTRO COMBUSTIBLE	FUEL FILTER	1
REC6P3-24564-00	TÓRICA	O-RING	1
PAF15-04000003	ARANDELA	WHASER	1
RECKITY200-250AL	KIT ÁNODOS	KIT ANODES	1
REC90430-08020	JUNTA DESAGÜE	DRAIN GASKET	2
REC91490-30025	PIN BLOQUEADOR	COTTER PIN	1
REC61A-W0078-A1	KIT BOMBA DE AGUA	WATER PUMP REPAIR KIT	1

F200C (2006-12)

RECKITF200C

REC6E5-11325-00AL	ANODO	ANODE	6
REC67F-12411-01	TERMOSTATO	THERMOSTAT	2
REC35-822626Q15	FILTRO DE ACEITE	OIL FILTER	1
REC68V-11325-01	ANODO	ANODE	2
NGKLF6A-11	BUJÍA	SPARK PLUG	6
REC63P-13915-00	FILTRO COMBUSTIBLE	FUEL FILTER	1
REC6P2-14984-00	TÓRICA VST	VST O-RING	1
REC69J-24501-10	FILTRO COMBUSTIBLE	FUEL FILTER	1
REC6P3-WS24A-00	FILTRO COMBUSTIBLE	FUEL FILTER	1
REC6P3-24564-00	TÓRICA	O-RING	1
PAF15-04000003	ARANDELA	WHASER	1
REC91490-30025	PIN BLOQUEADOR	COTTER PIN	1
REC90430-08020	JUNTA DESAGÜE	DRAIN GASKET	2
RECKITY200-250AL	KIT ÁNODOS	KIT ANODES	1
REC61A-W0078-A1	KIT BOMBA DE AGUA	WATER PUMP REPAIR KIT	1

F225B (2012+)
F200C (2012+)**RECKITF225B**

REC6E5-11325-00AL	ANODO	ANODE	7
REC67F-12411-01	TERMOSTATO	THERMOSTAT	2
REC35-822626Q15	FILTRO DE ACEITE	OIL FILTER	1
REC67F-11325-01AL	ÁNODO	ANODE	4
NGKLF6A-11	BUJÍA	SPARK PLUG	6
REC6CB-24501-01	FILTRO COMBUSTIBLE	FUEL FILTER	1
REC6CB-13016-00	TÓRICA	O-RING	1
REC63P-13915-00	FILTRO COMBUSTIBLE	FUEL FILTER	1
REC6P2-14984-00	TÓRICA VST	VST O-RING	1
REC6P3-WS24A-00	FILTRO COMBUSTIBLE	FUEL FILTER	1
REC6P3-24564-00	TÓRICA	O-RING	1
PAF15-04000003	ARANDELA	WHASER	1
REC91490-30025	PIN BLOQUEADOR	COTTER PIN	1
REC90430-08020	JUNTA DESAGÜE	DRAIN GASKET	2
RECKITY200-250AL	KIT ÁNODOS	KIT ANODES	1
REC61A-W0078-A1	KIT BOMBA DE AGUA	WATER PUMP REPAIR KIT	1

**KIT**F225C (2009-15)
F250A (2006-13)**RECKITF225C**

REF

REC6E5-11325-00AL	ANODO	ANODE	7
REC67F-12411-01	TERMOSTATO	THERMOSTAT	2
REC35-822626Q15	FILTRO DE ACEITE	OIL FILTER	1
REC67F-11325-01AL	ÁNODO	ANODE	1
NGKLF6A-11	BUJÍA	SPARK PLUG	4
REC6CB-24501-01	FILTRO COMBUSTIBLE	FUEL FILTER	1
REC6CB-13016-00	TÓRICA	O-RING	1
REC63P-13915-00	FILTRO COMBUSTIBLE	FUEL FILTER	1
REC6P2-14984-00	TÓRICA VST	VST O-RING	1
REC6P3-WS24A-00	FILTRO COMBUSTIBLE	FUEL FILTER	1
REC6P3-24564-00	TÓRICA	O-RING	1
PAF15-04000003	ARANDELA	WHASER	1
REC91490-30025	PIN BLOQUEADOR	COTTER PIN	1
REC90430-08020	JUNTA DESAGÜE	DRAIN GASKET	2
RECKITY200-250AL	KIT ÁNODOS	KIT ANODES	1
REC6P2-W0078-00	KIT BOMBA DE AGUA	WATER PUMP REPAIR KIT	1

F225F (2011+)
F225B (2009+)
F250D (2011+)
F300B (2011+)
F300C (2018+)**RECKITF250D**

REC6CE-12411-00	TERMOSTATO	THERMOSTAT	2
REC6AW-1132P-00	ANODO	ANODE	4
REC68T-11325-00AL	ANODO	ANODE	2
REC99999-03946	ANODO	ANODE	2
REC26-13440-00	FILTRO DE ACEITE	OIL FILTER	1
REC67F-11325-01AL	ÁNODO	ANODE	8
NGKLF6A-11	BUJÍA	SPARK PLUG	6
REC6CB-24501-01	FILTRO COMBUSTIBLE	FUEL FILTER	1
REC6CB-13016-00	TÓRICA	O-RING	1
REC63P-13915-00	FILTRO COMBUSTIBLE	FUEL FILTER	1
REC6CB-14984-00	TÓRICA VST	VST O-RING	1
REC6P3-24564-00	TÓRICA	O-RING	1
REC6P3-WS24A-00	FILTRO COMBUSTIBLE	FUEL FILTER	1
PAF15-04000003	ARANDELA	WHASER	1
REC91490-30025	PIN BLOQUEADOR	COTTER PIN	1
REC90430-08020	JUNTA DESAGÜE	DRAIN GASKET	2
RECKITY200-250AL	KIT ÁNODOS	KIT ANODES	1
REC6CE-W0078-01	KIT BOMBA DE AGUA	WATER PUMP REPAIR KIT	1

F300A (2008-11)

RECKITF300A

REC6AW-12411-00	TERMOSTATO	THERMOSTAT	2
REC6AW-1132P-00	ANODO	ANODE	8
REC26-13440-00	FILTRO DE ACEITE	OIL FILTER	1
NGKLF6A-11	BUJÍA	SPARK PLUG	8
REC6AW-11325-00	ANODO	ANODE	4
REC6AW-1132L-00	ANODO	ANODE	10
REC99999-03946	ANODO	ANODE	4
REC63P-13915-00	FILTRO COMBUSTIBLE	FUEL FILTER	1
REC6AW-14984-00	TÓRICA VST	O-RING VST	1
REC6P3-WS24A-00	FILTRO COMBUSTIBLE	FUEL FILTER	1
REC6P3-24564-00	TÓRICA	O-RING	1
PAF15-04000003	ARANDELA	WHASER	1
RECKITY300-350XPAL	KIT ÁNODOS	KIT ANODES	1
REC90430-08020	JUNTA DESAGÜE	DRAIN GASKET	2
REC91490-30025	PIN BLOQUEADOR	COTTER PIN	1
REC6AW-W0078-00	KIT BOMBA DE AGUA	WATER PUMP REPAIR KIT	1

F350A (2008 +)

RECKITF350A

REC6AW-12411-00	TERMOSTATO	THERMOSTAT	2
REC67F-11325-01AL	ÁNODO	ANODE	10
REC63P-11325-01AL	ÁNODO	ANODE	1
NGKLF6A-11	BUJÍA	SPARK PLUG	8
REC26-13440-00	FILTRO DE ACEITE	OIL FILTER	1
REC6AW-1132R-00	ANODO	ANODE	2
REC6AW-1132P-00	ANODO	ANODE	8
REC6CB-24501-01	FILTRO COMBUSTIBLE	FUEL FILTER	1
REC6CB-13016-00	TÓRICA VST	O-RING VST	1
REC63P-13915-00	FILTRO COMBUSTIBLE	FUEL FILTER	1
REC6CB-14984-00	TÓRICA VST	O-RING VST	1
REC6P3-24564-00	TÓRICA	O-RING	1
REC6P3-WS24A-00	FILTRO COMBUSTIBLE	FUEL FILTER	1
REC6E5-11325-00AL	ÁNODO	ANODE	1
RECKITY300-350AL	KIT ÁNODOS	KIT ANODES	1
REC6AW-11325-00	ÁNODO	ANODE	1
REC6AW-1132T-00	ÁNODO	ANODE	2
REC6AW-1132U-00	ÁNODO	ANODE	1
REC63P-11325-11AL	ÁNODO	ANODE	8
PAF15-04000003	ARANDELA	WHASER	1
REC90430-08020	JUNTA DESAGÜE	DRAIN GASKET	2
REC6AW-W0078-00	KIT BOMBA DE AGUA	WATER PUMP REPAIR KIT	1
REC91490-30025	PIN BLOQUEADOR	COTTER PIN	1

SISTEMA DE ALIMENTACIÓN Y FILTRACIÓN FUEL & FILTRATION SYSTEM

BOMBA DE COMBUSTIBLE

FUEL PUMP

REF	OEM
REC6BX-24360-00	6BX-24360-00



REF	OEM	Image
PAF15-09000000	6G1-24306-55 6Y1-24306-55	
		6 mm x 3 m



COMPONENTES TANQUE Y CONECTORES

FUEL TANK COMPONENTS & CONNECTORS

TAPÓN CON RESPIRADERO

PLUG WITH BREATHER

REF	OEM
PAF15-10010000	6YJ-24610-01 6YJ-24610-00



TAPÓN

PLUG

REF	OEM	Image
PAF4-04120100	67D-24610-00	
	67D-24610-02	
	67D-24610-03	
	67D-24610-04	
	68D-24610-10	
		F2.5 F4

RESORTE DE SEGURIDAD PARA TAPÓN

SPRING, PREVENT DESQUAMATING

REF	OEM
PAF4-04120103	624-24634-00



FILTRO

FILTER

REF	OEM
PAF15-10000002	6YJ-24167-00



CONECTOR DE DEPÓSITO

TANK CONNECTOR

REF	OEM	Image
GS31074	6Y1-24305-05-00	
	6Y1-24305-06, -00	
	6YL-24305-01-00	
	6G1-24305-00, 01, 02	
	6G1-24305-02-00	
	6G1-24305-03, -00	
	6G1-24305-04, -00	
GS31075	6G1-24305-05, -00	
	6G1-24305-0500	
	6Y1-24305-00, -01, -02	
	6Y1-24305-05-00	
	6Y1-24305-06-00	
REC6G1-24304-02	6G1-24304-02	6 mm

GS31074
GS31075

REC6G1-24304-02

LLAVE DE CIERRE DE DEPÓSITO

KNOB OIL SWITCH

REF	OEM	
PAF2.6-0000004	69M-24575-00	F2.5



MEDIDOR DE COMBUSTIBLE

OLEOMETER ASSY

REF	OEM
PAF15-10020000	6YJ-24260-00
	6YJ-24260-10
PAF15-10000003	6Y1-24268-00

PAF15-10000003





PAF15-10020000



FILTRO DE COMBUSTIBLE Y ELEMENTOS FUEL FILTERS AND ELEMENTS

FILTRO COMBUSTIBLE PARA MONTAJE EN LINEA

IN-LINE FUEL FILTER

REF	OEM			
REC40145	65W-24251-10	1/4"	1/4"	plástico plastic
REC40155	65W242511000	5/16"	5/16"	
REC40165	67F-24251-02	3/8"	3/8"	
REC40135		5/16"	3/8"	



REF	OEM	
REC6F5-24563-00	6F5-24563-00	9.9 hp
REC61N-24563-10	61N-24563-10	
	61N-24563-00	



REC61N-24563-10



REC6F5-24563-00

REF	OEM	
PAF4-04120005	6L5-24251-00	



REF	OEM	
REC35-80365M	646-24251-02	6 mm
PAF4-05000300	646-24251-01	



REF	OEM		
REC6C5-24251-00		F30 (2009+)	F75 (2005)
		F40 (2006+)	F80 (2008+)
		F50 (2005+)	F100 (2005+)
		F60 (2005+)	F115 (2014+)
		F70 (2011+)	F130 (2015+)



REF	OEM	
REC68T-24251-00	68T-24251-00 68T-24251-01 6EE-F4251-00	F6, F8 (2001+)



REF	OEM	
REC68V-24563-00	68V-24563-00	EUROPE F40 F50 F50
		F80 F100 F115



REF	OEM	
PAF15-07080000	61N-24560-00	15 - 60 hp



REF	OEM	
PAF15-07080002	61N-24521-00	plástico plastic



REF	OEM	
REC6BG-13915-00	6BG-13915-00	F30 (2013) F75 (2005-13)
		F40 (2008-13) F90 (2005-13)
		F50 (2005-13) T50 (2005-13)
		F60 (2005-13) T60 (2005-13)
		F70 (2010-13)



REF	OEM	
REC65L-24563-00	65L-24563-00	F200 (2002-06)
		F150 (2004-06)
		225FETO (2003)
		L/250B (1997-2003)



REF	OEM	
REC6C5-13915-00	6C5-13915-00	F50 (2005-13) F90 (2005-13)
		F60 (2005-13) T50 (2005-13)
		F70 (2010-13) T60 (2005-13)
		F75 (2005-13)



REF	OEM	
REC6C5-13915-00	6C5-13915-00	F150-F225 (2006-14)
		F250 (2005-14)





REF	OEM	
REC6D8-WS24A-00	6D8-WS24A-00 6D8-24563-00	F50 - F115



REF	OEM	
REC6P3-WS24A-00	6P3-WS24A-00 6P3-WS24A-01 6P3-24563-00	F150 (2007-11) F350 (2008-11)
		Z200 (2007) F250 (2009-11)
		Z150/175 (2007) Z300 (2007)
		F225 (2007-11) F300 (2011)
		F200 (2007-11)

REF	OEM
REC6P3-24564-00	6P3-24564-00

REF	OEM	
REC68F-24563-10	68F-24563-10	150-300HP (2004-06) Z, VZ, LZ



REF	OEM	
REC69J-24502-00	69J-24502-00	LF/FL/F150A,T,D,B (2005+)
		LF/FL/F200A,T,B (2004-11)
		LF/FL/F225T,A (2004-11)
		F75T, B (2005)
		F80B,A (2005+)
		F90,T,B,A (2013+)
		F100D (2005+)



REF	OEM	
REC6P2-WS245-00	6P2-WS245-00 6P2-24563-00	F (L) 200C
		F (L) 250A







REF	OEM	
REC68F-24563-00	68F-24563-00	(L) Z 150P, Q
		(L) Z 175 G
		(L) Z 200N/P
		(L) Z 250 D/F



REF	OEM	
REC64J-24560-10	64J-24560-00 64J-24560-10	E75, 75AE, AET (2003-15)
		85 AED, AET (2003-15)
		F40(2002-07)
		T50, FT50, F50 (2001-16)
		T60, FT60, F60 (2002-07)





REF	OEM				
REC6D8-24560-08	6D8-24560-08 6D8-24560-09 68V-24560-01 68V-24560-00	REC68V-24563-00	REC93210-32738	5/16"	F60 - F115 HP
REC6R3-24560-00	6R3-24560-00	REC61N-24563-10	REC93210-32738	5/16"	115 -225 HP





REC6D8-24560-08

REC6R3-24560-00

GUÍA FILTROS DE COMBUSTIBLE FUEL FILTER GUIDE

	REF		REF
3A, F2,5A, F4A	PAF4-04120005	F100F	REC6D8-WS24A-00
4A, 5C, 6C, 8C	PAF4-05000300	F(L)150A, F(L)200A/F200B F(L)225A (-2006)	REC65L-24563-00
F4B, F5A, F6A, F6C, F8C/FT8D F9,9J/FT9,9L	REC68T-24251-00	F(L)150A, F(L)200A/F200B F(L)225A (2007+)	REC6P3-WS24A-00
F9,9C/FT9,9D, F15A F25A/FT25B (-2004)	REC40145	F(L)200, F(L)250A (-2006)	REC6P2-WS245-00
F9,9C (1001584+)		F(L)200C, F(L)250A (2007+)	REC6P3-WS24A-00
FT9,9D (1001139+)	REC61N-24563-10	F(L)225B / F225C, F(L)225F (V6 4,2L), F(L)250D (V6 4,2L)	
F15A (1009198+)		F(L)300A/F(L)300B(V6 4,2L)	REC6P3-WS24A-00
F25A & FT25B (1013331+) (2004+)		F(L)350A, F(L)200F/F(L)200G F175A	
F25G	REC6D8-WS24A-00	9,9F, 15F/F15C, F20B, 25N/F25D/FT25F, 30D, 40V, 50G/ F50A, 60F, 75C, 90A, 100A/F100B, 115C, (L)130B, (L)150F, 175D, (L)200F/200G, 225D	REC61N-24563-10
F30A, F40B	REC40145	115B	REC6F5-24563-00
FT50B (-2000)	REC61N-24563-10	115-225 HP	REC6R3-24560-00
FT50B (2001+)	REC68V-24563-00	225G/250B	REC65L-24563-00
F60A/FT60B (-2003)	REC68V-24563-00	(L)Z150P/(L)Z150Q, Z175G (L)Z200N/Z200P (-2004)	REC68F-24563-00
F60A/FT60B (2004+)	REC61N-24563-10	(L)Z150P/(L)Z150Q, Z175G (L)Z200N/Z200P (2005-06)	REC68F-24563-10
F60-F115	REC6D8-24560-08	(L)Z150P/(L)Z150Q, Z175G (L)Z200N/Z200P (2007+)	REC6P3-WS24A-00
F50F/FT50G, F60C/FT60D (-2006)	REC68V-24563-00	(L)Z250D/Z250F (-2003)	REC68F-24563-00
F50F/FT50G, F60C/FT60D (2007+)	REC6D8-WS24A-00	(L)Z250D/Z250F (2004-06)	REC68F-24563-10
F30B, F40F, F50H, F60F, FT50J FT60G, F70A	REC6D8-WS24A-00	(L)Z250D/Z250F (2007+)	REC6P3-WS24A-00
F80A, F100A (-2001)	REC40165	(L)Z300A (-2006)	REC68F-24563-10
F80A, F100A (2002+)	REC61N-24563-10	(L)Z300A (2007+)	REC6P3-WS24A-00
F80B, F100D, F(L)115A (-2006)	REC68V-24563-00		REC68F-24563-10
F80B, F100D, F(L)115A (2007+)/F(L)115B	REC6D8-WS24A-00		REC6P3-WS24A-00

FILTRO VST VST FILTER

REF	OEM		
REC68V-13915-00	F115 (2000-09) F200 TXR (2002-09) LF200 TXR (2002-09) F225 TXR (2002-09) F225 TUR (2002-09)		

REF	OEM	
REC68F-13915-00	HPDI 150 (2000-05) V-Max HPDI 150 (2000-09) HPDI 225 (2003-09) HPDI 250 (2003-09) HPDI 300 (2004-09)	

REF	OEM	
REC66K-13915-00	HDX150 (1999-05) LX150 (1999-01) PX150 (1999) SX150 (1999-04) VX150 (2000-04) LX200 (1999-01) SX200 (1999-05) V200 (1999) VX200 (2000-05) L225 (1999)	LX225 (2000-03) S225 (1999) SX225 (2000-03) V225 (1999) VX225 (2000-04) L250 (1999) LX250 (2000-03) SX250 (2000-03) VX250 (2002-04)



REF	OEM	
REC65L-13915-00	L225 (1997-98) S225 (1997-98) L250 (1997-98) V200 (1998) V225 (1998)	



YAMAHA

RECMAR

REF	OEM	
REC63P-13915-00	F150 TXR	(2004-09) F300 TXR (2007-09)
	F150 TLR	(2004-09) F300 TUR (2007-09)
	F150 TJR	(2009) F350 TXR (2007-09)
	LF150 TXR	(2004-09) F350 TUR (2007-09)
	F250 TXR	(2005-09) F225 TLR (2007-09)
	F250 TUR	(2005-09)



FILTRO DE ACEITE

OIL FILTER

REF	OEM	
REC68F-13440-00	LZ	TLR (2001-07)
	LZ300	Z250
	TR	TXR
	AETO-X-V (2004-07)	DETO
	Z175TR	X (2003-07)
	GETO-X (2002-07)	Z150P
	V	TXR
	Z200T	PETO (2000-07)
PETO		



REF	OEM
REC5GH-13440-60	5GH-13440-60 5GH-13440-50



REF	OEM	
REC35-80365M	L150	
	L200	
	225	
	175	
	250	
	115	
	130	
	646-24251-02	



REF	OEM	
REC69J-13440-04	69J-13440-00, 01, 02, 03, 04	3/4" x 16NPT
REC5GH-13440-00	5GH-13440-00, 30, 70	20 x 1.5
REC26-13440-00	N26-13440-00, 02	3/4" x 16 NPT
REC3FV-13440-00	3FV-13440-00, 10, 20, 30	20 x 1.5



REF	OEM
REC6G8-13440-00	6G8-13440-00

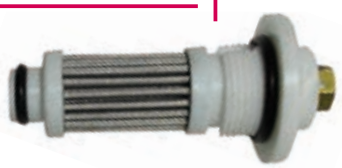

GUÍA FILTROS DE ACEITE

OIL FILTER GUIDE

	REF
F8A	REC6G8-13440-00
F9,9A/B	
FT9,9A (1990+)	
F9,9C (2000+)	
FT9,9D (2000+)	
F15A (2000+)	
F20A(2000+)	
F25A (2000+)/FT25B	
F30A	
F40A (2000+)/F40B (2001+)	
F50A(1999-05)/F50F(-2005)/FT50B (2000+)/FT50C (-2005)/FT50G (-2005)	REC5GH-13440-00
F60A (-2005)/F60C(-2005)/FT60B (-2005)/FT60D (-2005)	
F80A (2000+)/F80B	
F100A (2000+)/F100B/F100D	
F(L)115A/F115B/F100F	
F15C (2007+)	
F20B (2007+)	
F25D/G FT25F	
F30B	
F40F	
F50A, FT50C, F50F, FT50G, (2006+)	REC5GH-13440-60
FT60B, F60A, F60C, FT60D (2006+)	
F50H/F60F/FT50J/FT60G	
F70A/VX	
CRUISER/DELUXE (2008-11)	
VX SPORT 08/FX/FX HO/FX HO CRUISER 08	

	REF
F9,9C (1998), FT9,9D (1999)	REC3FV-13440-00
F15A (1998)	
F20A (1998)	
F25A (1998-99)	
F40A (1999), F40B (2000)	
50A (1995-98), FT50B (1996-99)	
F80A, F100A (1999)	
F(L)150A/F175A/F(L)200A/F(L)200C/F(L)200F/F(L)200G/ F(L)225A/F(L)225B/F225C/F(L)250A/F(L)250B/FX SHO/FX SHO CRUISER/FX HO CRUISER/FZR/FZS	
F(L)300A/F(L)350A/F(L)225F/F(L)250D/F(L)300B	
FX140/FX140	
CRUISER/FX160/FX160	REC5GH-13440-00
CRUISER/FX-H.O CRUISER/FX-HIGH OUTPUT/VX 1100SPORT & DELUXE	

BOMBA DE COMBUSTIBLE

FUEL PUMP

BOMBA DE COMBUSTIBLE MECANICA

REF	OEM	2T STROKES	4T STROKES	
PAF20-05050000	6AH-24410-00		✓	F9.9H (2009+) F13.5B (2007-09) F15C,E,M (2007+) F20B,E,M (2007+)



REF	OEM	2T STROKES	4T STROKES	
REC68V-24410-00	68V-24410-00		✓	F100B (2003-10) F100C (2001-07) F90 (2003-04) F75A, T (2003-04) F100A (2003-06) F80A (2002-07) F115A, TR, J (2000-10)



REF	OEM	2T STROKES	4T STROKES	
REC6E5-24410-03	6E5-24410-01-00		✓	V4 V6 (1989-03)



REF	OEM	2T STROKES	4T STROKES	
PAF15-07140000	66M-24410-11		✓	F9.9/13.5/15



REF	OEM	2T STROKES	4T STROKES	
REC6C5-24410-00	6C5-24410-00		✓	F30B (2009+) F40A/D/H/F (2006+) F50F/T/H/J/G (2005+) F60A/B/C/D/F/G/T (2005+)



FUEL PUMP MECHANICAL

REF	OEM	2T STROKES	4T STROKES	
REC68T-24410-00-00	68T-24410-00/01		✓	F9.9/1F6A/B/M (2000-09) F8C/M/E/D/PF/G (2000+) F9.9F/M/E/G/J/L (2008+)



REF	OEM	2T STROKES	4T STROKES	
PAF4-04090000	67D-24410-03		✓	F4



REF	OEM	2T STROKES	4T STROKES	
REC692-24410-00	692-24410-00 6A0-24410-00/03/04/05		✓	25-85HP



REF	OEM	2T STROKES	4T STROKES	
REC692-24410-00	6A0-24410-00/01/02/03/04		✓	20 - 90 HP (1985-92)



REF	OEM	2T STROKES	4T STROKES	
REC6D8-24410-10	6D8-24410-10		✓	F75B, T F80A, B, C F100D, B F115A



YAMAHA

RECMAR®

REF	OEM	2T STROKES	4T STROKES	
PAF25-05130000	62Y-24410-00/01/02/03/04 62Y2441000/1/2/3/4 62Y244100400		✓	F20-->F60





BOMBA DE COMBUSTIBLE ELÉCTRICA



FUEL PUMP ELECTRIC

REF	OEM	2T STROKES	4T STROKES	
REC68F-13907-01	68F-13907-01	✓		VZ, Z150 (2000-07) VZ, Z175 (2001-07) V, L, Z200 (2000-07)



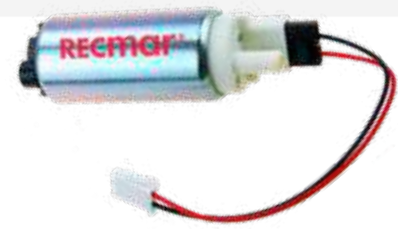

REF	OEM		2T STROKES	4T STROKES	
REC63P-13907-03	63P-13907-00/01/02/03	REC63P-14984-00		✓	F150 A/AET/AETL/AETX/AET1/AET2/BET/BETX/DET/DET/DET F150 TRC/TXRC/TLRC/TR/TLRD/TLR/TLRF/TRG/TXR/TRF (2004+)





REF	OEM		2T STROKES	4T STROKES	
REC69J-13907-03	69J-13907-00/01/02/03/04	REC68V-14984-00		✓	F200 A/AETX/AET/AETU F200 TXRA/TXRB/TXRC/TXRD/TR/TXR/TXRF F225 A/AETU/AETX/AET/TXRA/TXRB/TXRC/TXRD/TXRF F225 TXR/TR/TURD/TURC (2002-10)





REF	OEM		2T STROKES	4T STROKES	
REC69J-24410-02	69J-24410-00/01/02	REC6P2-14984-00		✓	F200 A/AETX/AET/CETX F200 TXRA/TXRB/TXRC/TXRD/TR/TXR/TXRF F225 A/AETU/AETX/AET/B/BETU/BETX/CET/CETL F225 TXRA/TXRB/TXRC/TXRD/TXR/TXRF/TR/TURD/TURC F250 AET/AETX/AETU/A/BET/ BETX/BETU F250 TXR/TURF/TXRF (2002-11)





REF	OEM		2T STROKES	4T STROKES	
REC6AW-13907-00	6AW-13907-00 6P2-13907-00	REC6AW-14984-00		✓	F200 C/ CETX (2006-11) F225 B /BETX/CET/CETL (2006-11) F225 BETU/BETX/A/AETU/AETX/TURF/TRG/TXRF (2006-11) F250 A/B/T (2006-11) F350 AET/AETU/AETX/TRG/TURG (2008-11)





REF	OEM	2T STROKES	4T STROKES	
REC67H-13907-00	66K-13907-00 65L-13907-00	✓		
225G (1999-02) 250BETO (1997-02) L/SX250 TXR (2000-02) 225FETO/FETOX (2003)				





REF	OEM	2T STROKES	4T STROKES	
REC67H-13907-00	67H-13907-00	✓		
225G/GETOL/FETO (2002-04) 250B/BETO/TXRA (2002-04)				





REF	OEM	2T STROKES	4T STROKES	
REC6BG-13910-03	6BG-13910-00 /01/ 02/ 03			
F40F, A (2009+) F30B (2009+)				





REF	OEM	2T STROKES	4T STROKES	
REC60V-13907-00	60V-13907-00	✓		
Z, LZ 250 (2003-07) Z, LZ 300 (2003-07)				



REF	OEM		2T STROKES	4T STROKES	
REC68V-13907-00	68V-13907-00, 01, 02, 03, 04, 05, 06	REC68V-14984-00	✓	✓	
Z, LZ 250DET/TR/FET (2003-07) Z, LZ 300AET/TR/TX (2004-07) LF/FL/F115A,T (2000-06)					







REF	OEM		2T STROKES	4T STROKES	
REC866169T01	6C5-13907-00	REC6C5-14984-00		✓	
F40D/G/H (2006+) T/FT/F50F/H/T (2005+) T/FT/F60A/B/C/F/T (2005+) F70A (2011+) F75C/T (2005-09) F80A/B/C (2005+) F90A/B/T (2005+) F100D (2005+)					







MEMBRANAS Y JUNTAS DIAPHRAGMS & GASKETS



REF	OEM		
REC6G1-24411-00	6G1-24411-00	3-15HP	



REF	OEM		
REC677-24471-01	677-24471-01	E8D 9.9D 15D	

REF	OEM		
REC6E0-24411-00	6E0-24411-00	4C/5C/AC	



REF	OEM		
REC63V-24411-00	63V-24411-00	9.9 13.5 15HP	



REF	OEM		
REC6E0-24471-00	6E0-24471-00	4HP	



REF	OEM		
REC677-24411-02	677-24411-02	9.9>15HP	



REF	OEM		
REC6G1-24471-00	6G1-24471-00	6-8HP	



REF	OEM		
REC648-24411-00	648-24411-00	20>70HP	



REF	OEM		
REC692-24411-00	692-24411-00	20>90HP	



REF	OEM		
REC6G1-24431-01	6G1-24431-01	3A/MSH 6C/CEM/D/DEM/TRV/MSH/CMH 8C/CEM/TRV/MSH/CMH/MH 9.9F, 13.5AWH, 15F	



REF	OEM		
REC6E0-24434-00	6G1-24431-01	4AC/MSH/AS/A 5C/CS/CMH	



REF	OEM		
REC6E0-24435-00	6E0-24435-00	4AC/MSH/AS/A 5C/CS/CMH	



REF	OEM		
REC677-24435-01	677-24435-01	9.9D 15D 20DM/DEO 25NE/NEMO	



REF	OEM		
REC663-24411-00	663-24411-00	25>90HP	



REF	OEM		
REC6J8-24471-00	6J8-24471-00	30HP	

REF	OEM		
REC648-24435-02	648-24435-02	20C/CM 25Q/D/B/BMH 25V/VE E30HMH 30G/H 40V/VM/VE/YE C40 E40 E40X 40X	50G/GEO/GETO/H/D 55B/BE 60FEO/FETO/TLR E60H 70B/BETO 75CETO/AE E75B 80A/AE 85A/AE 90A/AEO/AET



REF	OEM		
REC648-24434-01	648-24434-01	20C/CM 25Q/D/B/BMH 25V/VE E30HMH 30G/H 40V/VM/VE/YE C40 E40 E40X 40X	50G/GEO/GETO/H/D 55B/BE 60FEO/FETO/TLR E60H 70B/BETO 75CETO/AE E75B 80A/AE 85A/AE 90A/AEO/AET

REF	OEM		
REC650-24431-A0	650-24431-A0	25-300HP	

REF	OEM		
REC6E5-24411-00	6E5-24411-00-00	115 150 175 200HP	

REF	OEM		
REC6E5-24471-00	6E5-24471-00	115>250HP	

REF	OEM		
REC6E5-24435-00	6E5-24435-00	100A/TLR 115A/ETN/BET/B/BICET/ TLR 130BETO 140AETO 150AETO/ETN/FETO 175AETO/DETO/BETO	200AETO/ETN V200/G/BETO 220AET 225DET/BETO 250AET Z300

REF	OEM		
REC6E5-24434-02	6E5-24434-02	100A/TLR 115A/ETN/BET/B/BICET/TLR 130BETO 140AETO 150AETO/ETN/FETO 175AETO/DETO/BETO	200AETO/ETN V200/G/BETO 220AET 225DET/BETO 250AET Z300

JUNTAS VST

VST GASKETS

REF	OEM	
REC68V-14984-00	68V-14984-00	Z, LZ 250DET/TR/FET (2003-07) Z, LZ 300AET/TR/TX (2004-07) LF/FL/F115A,T (2000-06)



REF	OEM	
REC63P-14984-00	63P-14984-00	F150 A/AET/AETL/AETX/AET1/AET2/BET/ BETX/DET/DET/DETX F150 TRC/TXRC/TLRC/TR/TLRD/TLR/ TLRF/TRG/TXR/TRF (2004+)



REF	OEM	
REC6P2-14984-00	62P-14984-00	F200 A/AETX/AET/CETX F200 TXRA/TXRB/TXRC/TXRD/TR/TXR/TXRF F225 A/AETU/AETX/AET/B/BETU/BETX/CET/ CETL F225 TXRA/TXRB/TXRC/TXRD/TXR/TXRF/TR/ TURD/TURC F250 AET/AETX/AETU/A/BET/ BETX/BETU F250 TXR/TURF/TXRF (2002-11)



REF	OEM	
REC6CB-14984-00	6CB-14984-00	F115 + (2012+) NEW MODEL

REF	OEM	
REC6C5-14984-00	6C5-14984-00	F40D/G/H (2006+) T/FT/F50F/H/T (2005+) T/FT/F60A/B/C/FT (2005+) F70A (2011+) F75C/T (2005-09) F80A/B/C (2005+) F90A/B/T (2005+) F100D (2005+)



REF	OEM	
REC6AW-14984-00	6AW-14984-00	F200 C/ CETX (2006-11) F225 B /BETX/CET/CETL (2006-11) F225 BETU/BETX/A/AETU/AETX/TURF/ TRG/TXRF (2006-11) F350 AET/AETU/AETX/TRG/TURG (2008-11)

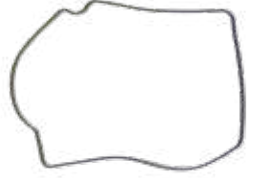

REF	OEM	
REC6CB-13016-00	6CB-13016-00	F115 +



REGULADORES DE PRESIÓN COMBUSTIBLE

FUEL REGULATOR

REF	OEM	
REC63P-13906-00	63P-13906-00	F150 (2004+) 63P/64P/6BM/6BN



REF	OEM	
REC69J-13906-00	69J-13906-00	F200 (2002-07) 60L / 60M F225 (2005-07) 69J / 69K



REF	OEM	
REC6P2-13906-00	6P2-13906-00	F200 (2006-11) 6AL / 6AM F225 (2007-11) 6AS/6AT/6BB F250 (2006-11) 6BR/ 6BS/6P



YAMAHA

RECMAR

INYECTORES

INJECTOR

INJECTOR

REF	OEM
REC6BG-13761-00	6BG-13761-00



REF	OEM
REC6C5-13761-00	6C5-13761-00



REF	OEM
REC6D8-13761-00	6D8-13761-00



REF	OEM
REC6AW-13761-00	6AW-13761-00



INJECTOR

REF	OEM
REC68V-8A360-00	68V-8A360-00 68V-13761-00



REF	OEM
REC6P2-13761-00	6P2-13761-00



REF	OEM
REC63P-13761-01	63P-13761-00/01





REF	OEM
REC69J-13761-00	69J-13761-00



GUÍA INYECTORES Y SENSORES

GUIDE INJECTORS & SENDERS

					TPS	MAP
F30B	6BT	2009+	REC6BG-13761-00			
F40 A/F	6BG	2009	REC6BG-13761-00			
F40 D/H/G	6AK & 6CY	2006+	REC6C5-13761-00		REC6C5-85885-00	REC68F-83688-00
F50 F/T/H/G/J	6C1 & 6C2	2005+	REC6C5-13761-00		REC6C5-85885-00	REC68F-83688-00
T50 A/B/T	6C2	2005+	REC6C5-13761-00		REC6C5-85885-00	REC68F-83688-00
F60 A/B/C/D/E/F/G/T	6C5 & 6C6	2005+	REC6C5-13761-00		REC6C5-85885-00	REC68F-83688-00
T60 A/B/T	6C6	2005+	REC6C5-13761-00		REC6C5-85885-00	REC68F-83688-00
F70 A	6CJ	2011+	REC6C5-13761-00		REC6C5-85885-00	REC68F-83688-00
F75 T/ B	6D61	2005	REC6D8-13761-00		REC6C5-85885-00	REC68F-83688-00
F80 C	6CK	2009-12	REC6D8-13761-00		REC6C5-85885-00	REC68F-83688-00
F80 B	6D7	2005+	REC6D8-13761-00		REC6C5-85885-00	REC68F-83688-00
F100 D	6D9	2005+	REC6D8-13761-00		REC6C5-85885-00	REC68F-83688-00
F115 A/ T	68V & 68W	2000-11	REC68V-8A360-00		REC68V-85885-00	REC68V-82380-00
F115A	68V & 68W	2012-15			REC68V-85885-00	
F115 B	6EK & 6EL	2014+			REC6C5-85885-00	
F150 A/B/C/D/T	63P & 64P	2004-05	REC63P-13761-01	REC63P-13906-00	REC69J-85885-00	REC63P-82380-00
F150 A/T/B/D	63P & 64P	2005+	REC63P-13761-01	REC63P-13906-00	REC6S1-85885-00	REC63P-82380-00
F150 B/F	6BM & 6BN	2012+	REC63P-13761-01	REC63P-13906-00	REC6S1-85885-00	REC63P-82380-00

						TPS	MAP
F200 A/ T	60L et 60M	2000-05	REC69J-13761-00	REC69J-13906-00		REC69J-85885-00	REC68V-82380-00
F200 A/ T	60L et 60M	2006-07	REC69J-13761-00	REC69J-13906-00		REC6S1-85885-00	REC68V-82380-00
F200 C	6AL et 6AM	2006	REC6P2-13761-00	REC6P2-13906-00			
F200 A/B/C	6AL,6AM,6S19,6S29	20012+		REC6P2-13906-00			
F225 A/ T	69J et 69K	2000-07	REC69J-13761-00	REC69J-13906-00		REC69J-85885-00	REC68V-82380-00
F225 A/B/C	6AS,6BB et 6AT	2012-15		REC6P2-13906-00			
F250 A/ T	6P2 et 6P3	2006-11	REC6P2-13761-00	REC6P2-13906-00			
F250 A/ T	6P2 et 6P3	2012-13		REC6P2-13906-00			



CARBURADOR

CARBURATOR

CARBURADOR COMPLETO

FULL CARBURATOR

REF	OEM		2T STROKES	4T STROKES
REC6F6-14301-06	6F6-14301-06	E40G (2008+)	✓	



REF	OEM		2T STROKES	4T STROKES
PAF4-04140000	67D-14301-03	F4 (1998-05)		✓



REF	OEM		2T STROKES	4T STROKES
REC6B4-14301-00	6B4-14301-00	E15D (2003+)	✓	



REF	OEM	2T STROKES	4T STROKES
REC6G1-14301-01	6G1-14301-01	✓	



REF	OEM		2T STROKES	4T STROKES
PAF2.6-04000200	69M-14301-21	F2.5 (2003+)	✓	



REF	OEM	2T STROKES	4T STROKES
REC6E3-14301-05	6E3-14301-05	✓	



REF	OEM	2T STROKES	4T STROKES
PAF25-05070000	65W-14901-12	F25 ALL (1999-06)	✓

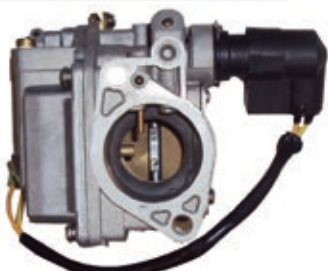

REF	OEM	2T STROKES	4T STROKES
REC6A1-14301-03	6A1-14301-03	✓	

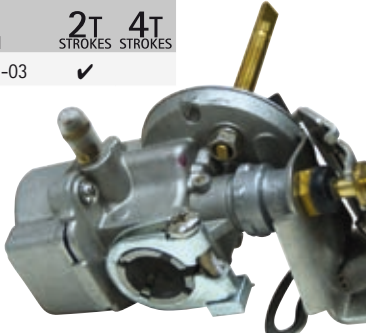

REF	OEM	2T STROKES	4T STROKES
REC61N-14301-04	61N-14301-04	✓	

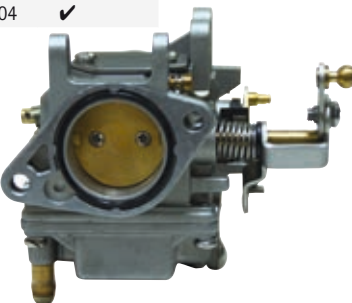

REF	OEM	2T STROKES	4T STROKES
REC66T-14301-60	66T-14301-60	✓	



REF	OEM	2T STROKES	4T STROKES
REC6L5-14301-03	6L5-14301-03	✓	



REF	OEM	2T STROKES	4T STROKES
REC63V-14301-00	63V-14301-00	REC63W-13610-00	✓

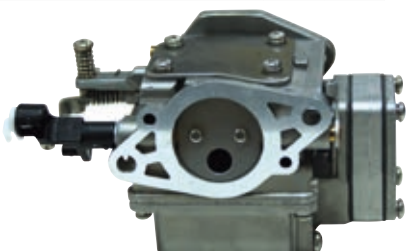

REF	OEM	2T STROKES	4T STROKES
PAF15-07090000	66M-14301-00	Arranque manual Manual starter	F9.9, F13.5, F15 (1998-07) ✓
PAF15-07090000W	66M-14301-00	Arranque eléctrico Electric starter	



PAF15-07090000W



PAF15-07090000

KIT 3 CARBURADORES

KIT 3 CARBURETORS

REF	OEM
REC6K5-14301-03	6K5-14301-03 + 6K5-14302-03 + 6K5-14303-03

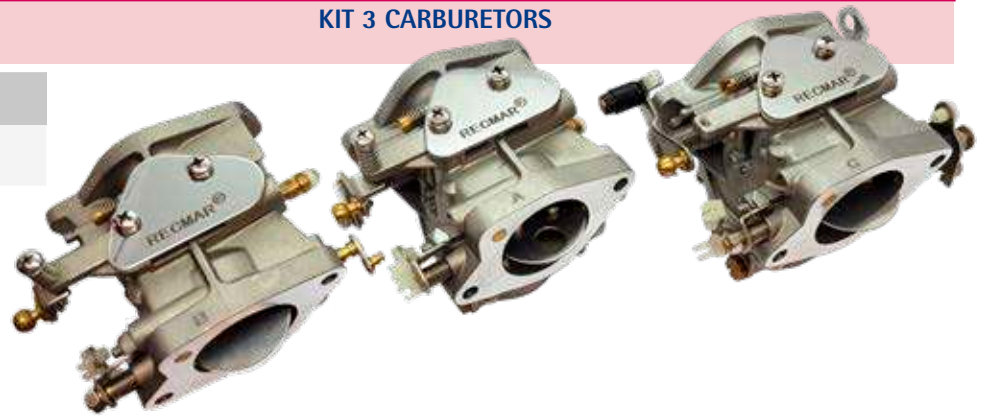

JUNTAS CARBURADORES

CARBURETOR GASKETS

REF	OEM	Icon	Image
REC677-14384-01	677-14384-01		
		E8D/DMH 9.9D 15D	

REF	OEM	Icon	Image
REC677-14227-00	677-14227-01		
		E8D/DMH 9.9D 15D	

REF	OEM	Icon	Image
REC6E7-14227-00	6E7-14227-00		
		9.9D 15D	

REF	OEM	Icon	Image
REC63V-14984-00	63V-14984-00		
		9.9F/FM/FEM/MS/MH/E9.9DMH 13.5AW 15F/FEM/MSH/FMH/MH E15DMH	

REF	OEM	Icon	Image
REC63V-14126-00	63V-14126-00		
		9.9F/FM/FEM/MS/MH/E9.9DMH 13.5AW 15F/FEM/MSH/FMH/MH E15DMH	

REF	OEM	Icon	Image
REC648-14384-01-00	648-14384-01		
		20C/CM 25D/DE 30A	

REF	OEM	Icon	Image
REC6L2-14399-00	6L2-14399-00		
		20DM/D/DEO/MLH E25A 25VE/VM/B/BMH/BWH/HMH/NMH/NE/N/ MLH/D 30G/GE E30HMH	

REF	OEM	Icon	Image
REC6L2-14384-00-00	6L2-14384-00		
		20DM/D/DEO/MLH E25A 25VE/VM/B/BMH/BWH/HMH/NMH/ NE/N/MLH/D 30G/GE E30HMH	

REF	OEM	Icon	Image
REC65W-14384-00	65W-14384-00		
		20 --> 40 HP	

REF	OEM	Icon	Image
REC6H4-14984-00	6H4-14984-00		
		25 - 90 HP	

REF	OEM	Icon	Image
REC6F5-14483-00	6F5-14483-00		
		E40/40J (2003+)	

REF	OEM	Icon	Image
REC66T-14384-01	66T-14384-01		
		E40XM/X/MLH/XW 40XW/XM	

REF	OEM	Icon	Image
REC66T-14536-01	66T-14536-01		
		40X/E40X/E40M	

YAMAHA

RECMAR

REF	OEM	
REC676-14984-00-00	676-14984-00	75A/AE/AET/AEM, E75B 85A/AE/AET/AFD

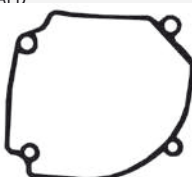

REF	OEM	
REC64D-14384-1	64D-14384-01	100A/AETO/TLR 225BET/AET 115A/B/BE/CE/BETO 175D/DET 130BETO 150F/FET/TLR/AET 140AETO 200AET/TLR/F/FET 150CET/ETD/AETO/CETO 225D/DET 175AETO/BETO/ET 115B/CET/TLR/TLR 200ETD 130BET 200CETO/AET/BET 250G/GET



KITS CARBURADORES

CARBURETOR KITS

REF	OEM	
REC6G1-W0093-00	6G1-W0093-00	3A/AMH//MSH/ (1988-07) 6C/CEM/N/J (1984-96) 8C/CEM/N/J (1984-96)



REF	OEM	
REC6E7-W0093-01	6E7-W0093-04	9.9D (1990-93) 15D (1990-93)



REF	OEM	
REC67D-W0093-00	67D-W0093-00	F4 (1999-02) F4A/AMH/MSH (1998-02)



REF	OEM	
REC63V-W0093-00	63V-W0093-00	9.9MH/FMH (1995-12) E9.9 13.5AMH (2003-04) 15FMH/MH (1995-12) E15DMH (2003)



REF	OEM	
REC66M-W0093-01	66M-W0093-01	F9.9C/FT9.9D (1998-08) F15A/ELH/MHZ/PL (1998-07)



REF	OEM	
REC6L2-W0093-00	6L2-W0093-00	20D/M (1998-11) 25N/M (1988-14)



REF	OEM	
REC677-W0093-00	677-W0093-00	9.9D (1985) 15D(1985)



REF	OEM	
REC689-W0093-02	689-W0093-02	20C/CM (1992-02) 25D/DE (1992-01) 30A (1992)



REF	OEM	
REC8542561	65W-W0093-02	F20A (2006-09) F25A/E (2006-09) FT/T25B/T (2006-09) F40B (2006-09) F30A (2006-09)

REF	OEM	
REC66T-W0093-01	66T-W0093-01	40XMH/XW (2000-13) E40X/MLH/XMH (2000-13)

REF	OEM	
REC6H4-W0093-03	6H4-W0093-03	25QEO (1993-1994) 40V/VM/VE (1995-14) C40T/TL (1995-02) 40YET (2005-07) 50H/HR/HM/HW/HE (1995-03)

REF	OEM	
REC6F6-W0093-00	6F6-W0093-00	E40 (2003)

REF	OEM	
REC6H2-W0093-10	6H2-W0093-10	25B/BETO (1994-1995) 50G/GE (1993-1998) 60FE/TL/TR (1992-2007) 70B/BE (1992-2014)

REF	OEM	
REC6H1-W0093-01-00	6H1-W0093-01	60FE-T/FEQ (1985-91) 70B/BEH/CEL (1985-90)

REF	OEM	
REC61N-W0093-00	61N-W0093-00	25VE/VM (1996-01) 25B/BMH/BW (2001-10) E30HMH (2003) 30G/GE (1996-00) 30HMH/HW (2003-12)

REF	OEM	
REC6H3-W0093-02	6H3-W0093-02	E60H/MHZ/MLH/HMHD/HW/HEHM (1997-14)

REF	OEM	
REC6H4-W0093-01-00	6H4-W0093-01	40H/E (1985-88) 50D (1985-88)

REF	OEM	
REC6H1-W0093-10	6H1-W0093-10	75CET (1998-2014) 75TLR (2000-02) 80A (2000-02) 90AE/TR/TL (1992-14)

REF	OEM	
REC67F-W0093-00	67F-W0093-00	F80A/TLR/ (1999-2001) F100A/TLR/TRZ/TLR (1999-2001)





REF	OEM	
REC6E5-W0093-08	6E5-W0093-08	115 BE (1997)



REF	OEM	
REC6E5-W0093-07	6E5-W0093-07	115BE/B (1996-2002) 115C/CET (2007-13) 130B/9BET (2007)





REF	OEM	
REC64D-W0093-00	64D-W0093-00	150A/AET/GET/FET/F (1996-00) 175DET/FET (1996-00) 200F/FET/G/GET (1996-00) 225D/DET (1996-97)



AGUJA CARBURADOR

NEEDLE VALVE

REF	OEM	
REC61N-14392-00	62Y-14392-00	2.5>60HP





REF	OEM	
REC6F5-14390-21	6F5-14390-21	40G/E40G 40J/E40J



REF	OEM	
REC6G1-14546-00	6G1-14546-01	8>40HP



REF	OEM	
REC696-14590-01	696-14590-01	48-55HP E48CMH E55CMH





REF	OEM	
REC626-14390-90	626-14390-90	9.9D/15D





REF	OEM	
REC6H3-14590-00	6H3-14590-01	E60/60FE/TR 70BET/TR F80-F100



REF	OEM	
REC677-14343-68	677-14343-68	9.9D/15D





REF	OEM	
REC6E8-14390-12	6E8-14390-12	9.9 - 15 HP E8D/9.9D/15D





REF	OEM	
REC688-14947-00	688-14947-00	75A/AE 85A/AE





REF	OEM	
REC6E5-14546-00	6E5-14546-00	25-250HP













REF	OEM	
REC692-14590-01	692-14590-00 692-14590-01	75A,C,TLR (1990-16) 80A (1984-02) 85A (1990-03) 90A,T (1984-18)



REF	OEM	
REC6F6-14341-00	6F6-14341-00	40G/40J E40G/E40J





TORNILLOS CARBURADOR

REF	OEM		
REC624-42542-00	90387-06119	3>300HP	
REF	OEM		
REC647-14323-00	647-14323-00	E8D 4A/MS, 30A 9.9D 20C, 5C 15D, 25D	
REF	OEM		
REC6F5-14323-00	6F5-14323-01	E40G/E40J 40G/40J	
REF	OEM		
REC692-14923-00	692-14923-00	40>90HP	
REF	OEM		
REC679-14923-00	679-14923-00	9.9F/M, 15F/M E9.9D, E15D 13.5 AM 8N/C/J 6C/D/TR/M 3A	

BOLT SCREW

REF	OEM		
REC50M-14355-00	50M-14355-00	20>50HP	
REF	OEM		
REC66T-14992-00	66T-14992-00	40X/E40X/E40M	
REF	OEM		
REC6A0-14325-00	6A0-14325-00	15>300HP	
REF	OEM		
REC6E5-14328-01	6E5-14328-01	115>225HP	
REF	OEM		
REC64D-14394-00	64D-14394-00	115-225HP	
REF	OEM		
REC6E5-14323-03	6E5-14323-03	115>250	

VÁLVULA DE LÁMINAS

REF	OEM			
REC6F6-13610-00	6F6-13610-00	40G/E40G 40J/E40J		
REF	OEM	2T STROKES	4T STROKES	
REC63W-13610-00	63W-13610-00	✓		9.9/15 HP (1995+)



VALVE OF SHEETS

REF	OEM	2T STROKES	4T STROKES	
REC688-13610-00	688-13610-00	✓		75A,C,T / E75 (1990+) 80A (1984-02) 85A (1900+) 90A,TR,TLR (2003+)



PASADOR DE BOYA



REF	OEM	
REC688-14548-00	688-14548-00	3>90HP
REC676-14186-00	676-14186-00	3>100HP
REC647-14386-10	647-14386-10	4AC/M/AS, FT/F9.9A/B 5C/CM/CS, T9.9EL 9.9D, F8AM/BM 15D



PIN FLOAT



REF	OEM		
PAF25-05070019	6H4-14548-00	9.9>100HP	
REC6E5-14386-01	6E5-14386-01	9.9>200HP	



BOYAS



REF	OEM		
REC6G1-14985-00	647-14323-00	3A/M E60 8C-M/T 60F 70B 40N-H 50E-D 6C/M/D	

REF	OEM		
REC647-14385-00	647-14385-00	4AC 5C 9.9D 15D	



REF	OEM		
REC6E7-14385-00	6E7-14385-00	4AC 5C E8D 9.9D 15D	



REF	OEM		
REC676-14966-00	679-14966-00	8>100HP	



REF	OEM		
REC63V-14985-00	63V-14985-00	9.9F-M 13.5A 15F-M F20 F25 F30 F40	



REF	OEM		
REC6L2-14385-00	6L2-14385-00	13.5>60HP	

FLOATS

REF	OEM		
REC648-14385-00	648-14385-00	20C 25D 30A	

REF	OEM		
REC6F6-14385-00	6F6-14385-00	40G/J E40G/J	

REF	OEM		
REC676-14985-01	676-14985-01	40Q 75A E75B 80A 85A 90A/E	

REF	OEM		
REC6E5-14385-02	6E5-14385-02	40X E40 100A 115C 115A-B 130B 150F/A 175D/A 200A 200G/F/B 225D 225A 250G	



REF	OEM	2T STROKES	4T STROKES	
REC6H4-14985-01	6H4-14985-00 6H4-14985-01 650-14385-00 6M6-14385-00	25-90 hp	75-100 hp	

CONECTOR DE CARBURADOR

REF	OEM	
PAF15-07000016	661-41262-01 661-41262-02	

ACCELEROGRAPH CONTROL



ELEMENTO FILTRO DEL CARBURADOR

REF	OEM		
REC67F-14371-01	67F-14371-01	F75 (2003-04) F80 (2002-03) F90 (2003-04) F100 (2002-03)	

**ELEMENT
FILTER (CARB INLET)**

GUÍA CARBURADORES

GUIDE CARBURETORS

			CARB	KIT		
2B, BMHS, MSHA/B/C/D	6A1-6A14	1985-05	REC6A1-14301-03			
3A, AMHL, MSH	6L5	1988-99	REC6L5-14301-03	REC6G1-W0093-00	REC6G1-14985-00	REC6G1-14546-00
3A, AMHS, AMHL, AMH, MSHA/B	6L50-6L59	2001-10	REC6L5-14301-03	REC6G1-W0093-00	REC6G1-14985-00	REC6G1-14546-00
3A AMH, AMHS	6L5A-6L5F	2011-15	REC6L5-14301-03	REC6G1-W0093-00	REC6G1-14985-00	REC6G1-14546-00
4AS	-6,00E+001	1994-95	REC6E3-14301-05		REC6E7-14385-00	
4AC	-6,00E+000	1994-98	REC6E3-14301-05		REC6E7-14385-00	
4CMHS/L	6GP1	2016	REC6E3-14301-05		REC6E7-14385-00	
5C	-6,00E+003	1986-99	REC6E3-14301-05		REC6E7-14385-00	
5CS	-6,00E+004	1987-95	REC6E3-14301-05		REC6E7-14385-00	
5CMH	6M0	1994	REC6E3-14301-05		REC6E7-14385-00	
5C, CMHS/L	6E30-6E39	2001-10	REC6E3-14301-05		REC6E7-14385-00	
5CMH, CMHS/L	6E3A-6E3F	2011-15	REC6E3-14301-05		REC6E7-14385-00	
6C, CEM	6H6	1984-96	REC6G1-14301-01	REC6G1-W0093-00	REC6G1-14985-00	REC6G1-14546-00
6D, DEM	6H8	1984-96	REC6G1-14301-01	REC6G1-W0093-00	REC6G1-14985-00	REC6G1-14546-00
6J	6H6	1986	REC6G1-14301-01	REC6G1-W0093-00	REC6G1-14985-00	REC6G1-14546-00
6C, MSH, TRV	6M8	1997-98	REC6G1-14301-01	REC6G1-W0093-00	REC6G1-14985-00	REC6G1-14546-00
6C	6M80	2001	REC6G1-14301-01	REC6G1-W0093-00	REC6G1-14985-00	REC6G1-14546-00
6D	6M90-6M91	2001-02	REC6G1-14301-01	REC6G1-W0093-00	REC6G1-14985-00	REC6G1-14546-00
6CMH, CMHS/L, MSHA/B/G/D, MH, MHL, CWH	6M81-6M89	2002-10	REC6G1-14301-01	REC6G1-W0093-00	REC6G1-14985-00	REC6G1-14546-00
CMH, CMHL, CM, MH	6M8A-6M8B	2010-12	REC6G1-14301-01	REC6G1-W0093-00	REC6G1-14985-00	REC6G1-14546-00
8N	6G1	1984	REC6G1-14301-01	REC6G1-W0093-00	REC6G1-14985-00	REC6G1-14546-00
8C, CEM	6G1	1984-95	REC6G1-14301-01	REC6G1-W0093-00	REC6G1-14985-00	REC6G1-14546-00
8J	6G1	1986	REC6G1-14301-01	REC6G1-W0093-00	REC6G1-14985-00	REC6G1-14546-00
8C, TRV, MSH	6N0	1997-98	REC6G1-14301-01	REC6G1-W0093-00	REC6G1-14985-00	REC6G1-14546-00
8C, MSHZ, MSHA	6N00-6N09	2001-10	REC6G1-14301-01	REC6G1-W0093-00	REC6G1-14985-00	REC6G1-14546-00
8CMH, CMHS/L	6N0A-6N0C	2011-12	REC6G1-14301-01	REC6G1-W0093-00	REC6G1-14985-00	REC6G1-14546-00
9.9FMH, FMHS/L, FEMH, MHW, MSH, MSHZ, MSHA/B/C	63V-63V9	1995-10	REC63V-14301-00	REC63V-W0093-00	REC63V-14985-00	REC6G1-14546-00
FMH, FMHS/L, MH	63VA-63VJ	2011-16	REC63V-14301-00	REC63V-W0093-00	REC63V-14985-00	REC6G1-14546-00
13.5AWH	63V	1998	REC63V-14301-00	REC63V-W0093-00	REC63V-14985-00	REC6G1-14546-00
13.5AMH, AMHS/L	66S1-66S2	2003-04	REC63V-14301-00	REC63V-W0093-00	REC63V-14985-00	REC6G1-14546-00
15F.FEMH, FMHS, MHW, MSH, MSHA	63W-63W1	1995-02	REC63V-14301-00	REC63V-W0093-00	REC63V-14985-00	REC6G1-14546-00
E15CMHS	65F2	2003	REC63V-14301-00	REC63V-W0093-00	REC63V-14985-00	REC6G1-14546-00
E15D	6B4	2003+	REC6B4-14301-00	REC63V-W0093-00	REC63V-14985-00	REC6G1-14546-00
15FMHS/L, FMH, MH, MSHB/C/G	63W2-63W9	2003-10	REC63V-14301-00	REC63V-W0093-00	REC63V-14985-00	REC6G1-14546-00
15FMHS/L, FMH, MH	63WA-63WG	2011-16	REC63V-14301-00	REC63V-W0093-00	REC63V-14985-00	REC6G1-14546-00
25VE	61R	1996	REC61N-14301-04	REC61N-W0093-00	REC6L2-14385-00	REC61N-14392-00
25VM	61R	1997	REC61N-14301-04	REC61N-W0093-00	REC6L2-14385-00	REC61N-14392-00
E25A	61N	1998	REC61N-14301-04	REC61N-W0093-00	REC6L2-14385-00	REC61N-14392-00
25VM	61R0	2001	REC61N-14301-04	REC61N-W0093-00	REC6L2-14385-00	REC61N-14392-00
30G	61T	1996	REC61N-14301-04	REC61N-W0093-00	REC6L2-14385-00	REC61N-14392-00
30GE	61T	1997	REC61N-14301-04	REC61N-W0093-00	REC6L2-14385-00	REC61N-14392-00
40X, XW	66T	1998-00	REC66T-14301-60	REC66T-W0093-01	REC6E5-14385-02	REC6E5-14546-00
40XMH	66T4-66T8	2003-05	REC66T-14301-60	REC66T-W0093-01	REC6E5-14385-02	REC6E5-14546-00
40XMH, XMHS/L	66TG-66TR	2009-12	REC66T-14301-60	REC66T-W0093-01	REC6E5-14385-02	REC6E5-14546-00
E40X, MLH	66T	1998-00	REC66T-14301-60	REC66T-W0093-01	REC6E5-14385-02	REC6E5-14546-00
E40X, XMH, XMHS/L/Z	66T0-66T8	2001-05	REC66T-14301-60	REC66T-W0093-01	REC6E5-14385-02	REC6E5-14546-00
E40X, XMHS/L, XMH, XMHX	66TA-66TR	2006-12	REC66T-14301-60	REC66T-W0093-01	REC6E5-14385-02	REC6E5-14546-00
E60H, HMHD, HMHDS/L, ELHB, MHZ, MLHA, HMHD, HWHD	69D0-69D9	2001-10	REC6K5-14301-03	REC6H3-W0093-02	REC6G1-14985-00	REC6H3-14590-00
E60HMHD, HMHDS/L, HWDL	69DA-69DC	2011-12	REC6K5-14301-03	REC6H3-W0093-02	REC6G1-14985-00	REC6H3-14590-00
E60HE, HM, E-60H	6K5	1996-00	REC6K5-14301-03	REC6H3-W0093-02	REC6G1-14985-00	REC6H3-14590-00

ACELERADOR

ACCELERATOR

VARILLA DE ACELERADOR

ROD ACCELERATOR LEVER

REF	OEM	
REC6H3-41217-00	6H3-41217-00	50G/E60H 60F/T 70B/T
REC688-41217-00	688-41217-00	80A 90A/E
REC6G5-41217-00	6G5-41217-01	150/200ETN 150/200AETO 175AET-O 225AETO



REF	OEM	
REC692-41256-00	692-41256-00	75A/B 80A 85A 90A



REF	OEM	
PAF2.6-04070200	6BG-41134-00	F25 --> F50



YAMAHA

RECMAR®

SISTEMA ELÉCTRICO

ELECTRIC SYSTEM

SENSORES

SENSORS

SENSOR TPS

REF	OEM
REC6C5-85885-00	6C5-85885-00



TPS SENDER

REF	OEM
REC6S1-85885-00	6S1-85885-00



REF	OEM
REC69J-85885-00	69J-85885-00



REF	OEM
REC68V-85885-00	68V-85885-00



SENSOR MAP

REF	OEM
REC68V-82380-00	68V-82380-00



MAP SENSOR

REF	OEM
68F-83688-10	



REF	OEM
REC63P-82380-00	63P-82380-00



REF	OEM
REC68F-83688-00	68F-83688-00



SENSOR IAC

REF	OEM	2T STROKES	4T STROKES	Icon
REC13650-52G00	63P-85886-00		✓	F150 --> F350



IAC SENSOR

REF	OEM	2T STROKES	4T STROKES	Icon	Notes
REC13650-56B00	65L-85886-00		✓		F115, F200, F225 L, Z 150/250 HP V, VZ, Z 200/300HP



YAMAHA

RECMOIR®

878



**SENSOR
TEMPERATURA DEL AGUA**

REF	OEM	
PAF25-05010201	65W-85790-00	F20A (1998-06) F25A,E,M (1998-09) T25 / FT25 (1998-09)



**SENSOR,
WATER TEMPERATURE**

REF	OEM	2T STROKES
REC688-82560-10	688-82560-10	40 - 300 hp (1984-16)



REF	OEM	
PAT40-05000100	6AH-82560-00	F9.9H (2009+) F13.5B (2007-09) F15C,E,M (2007+) F20B, E, M (2007+)



**SENSOR
PRESIÓN DE ACEITE**

REF	OEM	
PAF15-07010100	65W-82504-00 62Y-82504-10	F9.9 - F40



**SENSOR,
OIL PRESSURE**

BOBINAS

COILS

BOBINA DE LUZ

COIL LIGHTING

REF	OEM	2T STROKES	4T STROKES	
REC63V-85533-00	63V-85533-00	✓		9,9/15 F/M (1995+) 13,5 AM (2003-04) E9.9/15 (2003)



REF	OEM	2T STROKES	4T STROKES	
REC66T-85533-00	66T-85533-00	✓		E40 (1998+) 40X/M (1998+)



REF	OEM	2T STROKES	4T STROKES	
PAF15-07000400	66M-85533-00		✓	F15 ALL (1998-07) F9.9 ALL (1998-08) F13.5 ALL (2002-07)





BOBINA DE IGNICIÓN

IGNITION COIL

REF	OEM	2T STROKES	4T STROKES	
REC6A1-85570-00	6A1-85570-00	✓		2B,C,M (1995-10)



REF	OEM	2T STROKES	4T STROKES	
REC63V-85570-00	63V-85570-00 65E-85570-00	✓		9.9/15/13.5 (1995+) 63V & 63W E15 (2003) 65F & 65G 9.9/15 F/M (1995-13) 13.5A (2003-04) E15 (2003)



REF	OEM	2T STROKES	4T STROKES	
REC689-81311-40	66M-85570-00	✓		3A 40Q (1985-92) (1990-98)



REF	OEM	2T STROKES	4T STROKES	
REC6E7-85570-19	6E7-85570-19-00	✓		9.9/15HP (1988-95) 20C/D (1985-93) 25C/D (1985-93)



REF	OEM	2T STROKES	4T STROKES	
REC6E0-85570-00	6E0-85570-00	✓		4A/M/C (1996-18) 5C (1996-15)





REF	OEM	2T STROKES	4T STROKES	
PAF15-07000600	66M-85570-00		✓	F15 ALL (1998-07) F9.9 ALL (1998-08) F13.5 ALL (2002-07)





REF	OEM	2T STROKES	4T STROKES	
REC6B4-85570-01	6B4-85570-00 6B4-85570-01	✓		E9.9D (2003-13) E15D (2003+)



REF	OEM	2T STROKES	4T STROKES	
REC61N-85570-01	61N-85570-00 61N-85570-01	✓		20 D, DEM, MLH, MSH, DMH, DWC, DWH (6L3 - 6L3A) (1994-11) E25 A (61N) (1998) 25B, BMH, BWC, BWHVM (61R0 - 69RG) (2001-15) E25 BMH (63P3 - 69PG) (2003-15) 25 N, NE, MLH, MSH, NMH, NW, MH (6L2 - 6L2G) (1994-15) 30 G, C30 ELRW (61T - 61TO) (1998-01) 330 HMH (60B3) (2003)

REF	OEM	2T STROKES	4T STROKES	
REC6F5-85570-11	F5-85570-13	✓		F9.9 (2009+) F20/25 B/F (2007+) F13.5 B/M (2007+) F15 C/M/E (2007-09)





REF	OEM	2T STROKES	4T STROKES	
PAF25-05120000	65W-85570-01		✓	F20A/E (1998-06) F25A/B/T/M (1998-09)



REF	OEM	2T STROKES	4T STROKES	
REC6H3-85570-10	6H3-85470-10		✓	E60H/M (2001+) 60F (1984-91) 70B/C/E (1984-91)



REF	OEM	2T STROKES	4T STROKES	
REC66T-85570-00	66T-85570-00		✓	E40 (1998+) 40X/M (1998+)



REF	OEM	2T STROKES	4T STROKES	
REC67F-85570-00	67F-85570-00		✓	F80A/T (67G-67G5) (1999-06) F100A/B/C/T (2003-12)



REF	OEM	2T STROKES	4T STROKES	
REC6F6-85530-01	6F6-85530-01		✓	EK40G (2018) E40G (2006+)





REF	OEM	2T STROKES	4T STROKES	
REC6E5-85570-11	6E5-85570-11 6E5-85570-10		✓	115HP 4Cil. (1984-91) 140A/E (1984-89) 150 175 200HP (1984-89)





REF	OEM	2T STROKES	4T STROKES	
REC697-85570-00	697-85570-00	✓	✓	50G/ETOL (1995-07) 75T/L/A/C/B (1997-14) 85A/E/TDL/X (1997-03) 55 B/M/ET (1995-02) 90A/T/ETOL (1997-14) 60F/T/ETOL (1995-07) 70B/E/ETOL (1995-14)



REF	OEM	2T STROKES	4T STROKES	
REC6R3-85570-01	6R3-85570-01		✓	200 A/E/F (1997-10) 150 F/T (1994-07) 175D (1996-03) 225D (1996-09) 130 B/T (1994-07) 115 C/T (1994-13) 130 BETO (1994-01)

REF	OEM	2T STROKES	4T STROKES	
REC697-85570-10	697-85570-11		✓	55HP 2 Cil. (1989-94) 90A/ETN/AETO (1984-88) 80A (1984-89)





REF	OEM	2T STROKES	4T STROKES	
REC6CB-82310-00	6CB-82310-00	✓		

F150C, (2017+)
F175A,C (2014+)
F200F,B,G,C (2013+)
F225F,C,B,H,J (2011+)
F250D,C,F,P (2011+)
F300B,C,A,D,G (2011+)
F350A,C (2012-19)



BOBINA DE T.C.I. T.C.I. COIL

REF	OEM	2T STROKES	4T STROKES	
PAF2.6-04000600	69M-85640-00		✓	



REF	OEM	2T STROKES	4T STROKES	
PAF4-04000038	67D-85640-00		✓	



BOBINA DE CARGA CHARGE COIL

REF	OEM	2T STROKES	4T STROKES	
REC69P-85541-09	69P-85541-09	✓		

E25 B, BMH (69P1 - 69PG) (2001-15)
25 B, BMH, BWC, BWH, MWS (69R1 - 69RG) (2001-15)
E30 HMH (60B3) (2003)
30 H, HMH, HWH, HWS, HWL, HW, HWC (69S3 - 69SG) (200315)

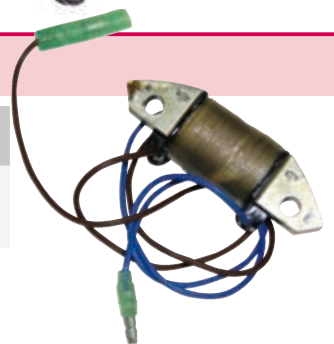

REF	OEM	2T STROKES	4T STROKES	
REC63V-85520-00	63V-85520-00	✓		

15F (1995+)
9,9 F/M (1995+)
13,5 A (2003-04)

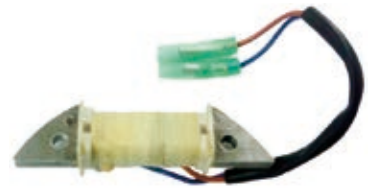

REF	OEM	2T STROKES	4T STROKES	
PAF15-07000300	66M-85520-00		✓	

F15 ALL (1998-07)
F9.9 ALL (1998-08)
F13.5 ALL (2002-07)



REF	OEM	2T STROKES	4T STROKES	
REC66T-85520-00	66T-85520-00	✓		

E40 (1998+)
40X/M (1998+)



REF	OEM	2T STROKES	4T STROKES	
REC6H3-85520-00	6H3-85520-00	✓		

E60H/M (2001+)
60F (1984-91)
70B/C/E (1984-91)



REF	OEM	2T STROKES	4T STROKES	
REC6B4-85520-00	6B4-85520-00	✓		

E9.9D / E15D



BOBINA DE PULSACIÓN

PULSER COIL

REF	OEM	2T STROKES	4T STROKES	
PAF20-05000100	6AH-85580-00		✓	F9.9H (2009+) F13.5B (2007-09) F15C/E/M (2007) F20/F30 (2009+)

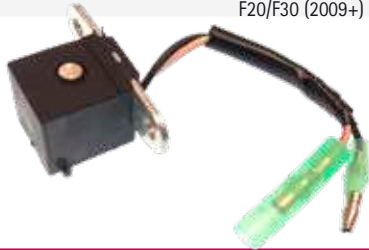

REF	OEM	2T STROKES	4T STROKES	
REC66T-85580-00	66T-85580-00	✓		E40 40X/M (1998+) (1998+)



REF	OEM	2T STROKES	4T STROKES	
REC6B4-85580-00	6B4-85580-00	✓		E9.9D / E15D



REF	OEM	2T STROKES	4T STROKES	
REC63V-85580-01	63V-85580-01	✓		9,9/15 F/M 13,5A (2003+) (2003-04)



REF	OEM	2T STROKES	4T STROKES	
PAF15-07000200	66M-85580-00		✓	F15 ALL (1998-07) F9.9 ALL (1998-08) F13.5 ALL (2002-07)



VOLANTE DE MOTOR

FLYWHEEL

SIN DIENTES (MANUAL)

WITHOUT TOOTH

REF	OEM	
PAF20-05000500	6AH-85550-00	F9.9H (2009+) F13.5B (2007-09) F15C,E,M (2007+) F20B, E, M (2007+)



REF	OEM	
PAF15-07070000	66M-85550-00	F9.9C, M (1998-08) FT9.9D (1999-08) F13.5A (2002-07) F15A,E,M (1998-07)



ELÉCTRICO

ELECTRIC

REF	OEM	
PAF20-05000500W	6AH-85550-10	F9.9H (2009+) F13.5B (2007-09) F15C,E,M (2007+) F20B, E, M (2007+)



REF	OEM	
PAF15-07070100W	66M-85550-10	F9.9C, M (1998-08) FT9.9D (1999-08) F13.5A (2002-07) F15A,E,M (1998-07)



MOTORES DE ARRANQUE

STARTERS

YAMAHA

REF	OEM			2T STROKES	4T STROKES		
PAF15-07150100W	66M-81800-00, 01, 02	12V	9 CCW	✓		REC89-825096T01	F9.9, F15, F13.5 (1998-08)



REF	OEM			2T STROKES	4T STROKES		
PAF20-05000900W	6AH-81800-00, 01	12V	11		✓		F13,5 ALL (2007-09) F15 (2007-14) F20 ALL (2007-14)



REF	OEM			2T STROKES	4T STROKES		
REC65W-81800-03	65W-81800-00, 01, 02, 03	12V	9 CCW		✓		F20 F25HP (1999-09) F30/F40 (2005-09)



REF	OEM			2T STROKES	4T STROKES		
REC689-81800-13	689-81800-10, 11, 12, 13	12V 0.6 kw	11 CCW	✓		REC89-825096T01	25-40HP 30HP/20HP



REF	OEM			2T STROKES	4T STROKES		
REC67C-81800-02	67C-81800-00, 01, 02	12V	9 CCW		✓		F30 (2000-09) F40 (2001-09)

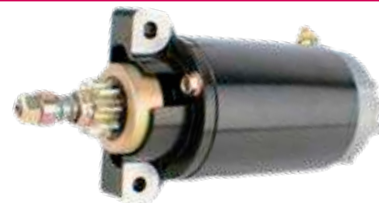

REF	OEM			2T STROKES	4T STROKES		
REC6J4-81800-01	6J4-81800-00, 01 6G8-81800-10, 11 6F5-81800-10, 11	12V	11 CCW	✓		REC89-825096T01	30 HP (1987+) 40-50 HP (1989+)



REF	OEM			2T STROKES	4T STROKES		
REC6H4-81800-12	6H4-81800-10, 11, 12	12V	9 CCW	✓			40-50 HP (1984-1988)



REF	OEM			2T STROKES	4T STROKES		
REC6E5-81800-12	6E5-81800-10, 11, 12	12V 1.1 kw	9 CCW	✓	✓	REC61A-81941-00	F45 / F50 115-130 HP V4 150-175-200 HP V6



REF	OEM	⚡	☀️	2T STROKES	4T STROKES	🔧
REC6H3-81800-11	6H3-81800-10, 11	12V 0,6 kw	9 CCW	✓	50HP 60HP 70HP	(1993-14) (1991+) (1984-14)

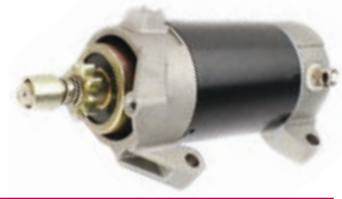

REF	OEM	⚡	☀️	2T STROKES	4T STROKES	🔧
REC99999-03249	99999-03249 697-81800-10, 11, 12 676-81800-10	12V 1.0 kw	9 CCW	✓	55-60HP	2 cyl



REF	OEM	⚡	☀️	2T STROKES	4T STROKES	🔧
REC688-81800-12	688-81800-10, 11, 12	12V	9 CCW	✓	75 HP 85 HP 90 HP 85HP 80HP	(1994-99) (1991-96) (1984-14) (1992-03) (1993-02)



REF	OEM	⚡	☀️	2T STROKES	4T STROKES	🔧
REC68V-81800-03	68V-81800-00, 01, 02	12V 1.4 kw	13 CCW	✓	F80 F100 F115 LF115	(2005+) (2005+) (2000+) (2000+)



REF	OEM	⚡	☀️	2T STROKES	4T STROKES	🔧
REC67F-81800-04	67F-81800-01, 02, 03, 04	12V 1.4 kw	13 CCW	✓	F80 HP F100 HP	(1999+) (1999+)



REF	OEM	⚡	☀️	2T STROKES	4T STROKES	🔧
REC6CE-81800-01	6CE-81800-00/01 6CB-81800-00/01	12V 1.4 kw	9 CCW	✓	F115B (2014) F175A,C (2014+) F150C,G (2017+) F200F,B,C,G (2013+) F225H,B,F,C (2011+) F250B,L,D,C,F,P,J (2011+) F300C,A,B,D,G (2011+)	



REF	OEM	⚡	☀️	2T STROKES	4T STROKES	🔧
REC99999-03938	99999-03938 61H-81800-00, 01 6K7-81800-10 6N7-81800-00, 01, 10	12V 1.4 kw	9 CCW	✓	115-250HP	V4



REF	OEM	⚡	☀️	2T STROKES	4T STROKES	🔧
REC6BR-81800-02	63P-81800-00 6BR-81800-00, 01	12V 1.4 kw	13 CCW	✓		FL, F150 AET, X, L (2009-11) FL, F200 CETX (2009-11) FL, F225 BET X, U, CET, L (2009-11) FL, F250 AET, X, U, BET, X, U (2009-11)



REF	OEM	⚡	☀️	2T STROKES	4T STROKES	🔧
REC6CJ-81800-01	6CJ-81800-00 6C5-81800-00 68F-81800-00, 01, 03	12V 1.4 kw	13 CCW	✓	✓	LZ 150-175 HP (2000+) VZ 150-175 HP (2000+) Z 150-175 HP (2000+) LZ 200-Z200 HP (2000+)



REF	OEM	⚡	☀️	2T STROKES	4T STROKES	🔧
REC69J-81800-01	69J-81800-00, 01	12V 1.4 kw	13 CCW	✓		F200, F225 HP (2002-2007)



REF	OEM	⚡	☀️	2T STROKES	4T STROKES	🔧
REC69W-81800-00	61A-81800-00, 01 69L-81800-00 69W-81800-00	12V	9 CCW	✓	✓	REC61A-81941-00 REC89-825096T01 (F40/50/60)
						V200 (1998+) F40 (2002-06) F50 (2003-14) F60 (2003-07) 225 HWP(1994+) 250 HP (1990+)



REF	OEM	⚡	☀️	2T STROKES	4T STROKES	🔧
REC60X-81800-00	60V-81800-00 60X-81800-00 6C9-81800-00 6D0-81800-00	12V 1.4 kw	13 CCW		✓	250HP (2003-07)



REF	OEM	⚡	☀️	2T STROKES	4T STROKES	🔧
REC6AW-81800-00	6AW-81800-00	12V 2.2 kw	13 CCW		✓	F350A,T,C (2008-19) F300A (2008-11) F425 (2019+)



REF	OEM	⚡	☀️	2T STROKES	4T STROKES	🔧
REC6FP-81800-01	6FP-81800-01	12V 1.4 kw	9 CCW			F100F (2017-20) F80D (2017-20)



REF	OEM	⚡	☀️	2T STROKES	4T STROKES	🔧
REC6BG-81800-00	6BG-81800-00 6BG8180000	12V 1.0kw	9 CCW		✓	F20D FT25F / T25A /F25D F30B F40A, F



MUELLE DE ARRANQUE

STARTER SPRING

REF	OEM	
PAF15-07130107	63V-15713-00	6 - 25 hp



REF	OEM	
REC66T-15713-00	66T-15713-00 6F5-15713-00, 01	25 - 40 hp



REF	OEM	
REC633-15713-10	663-15713-00	E60/75A/85A



TRINQUETE TRACCIÓN PLATO

PAWL, DRIVE

REF	OEM	2T STROKES	4T STROKES	
PAF15-07130202	63V-15741-00	✓	✓	6 - 40 hp



REF	OEM
PAF15-07130203	63V-15767-00
PAF15-07130204	63V-15784-00



PAF15-07130203

PAF15-07130204



REF	OEM
REC676-15471-00	676-15471-00



REF	OEM
REC677-15741-01	677-15741-01



CABLE DE MOTOR DE ARRANQUE A BATERÍA

CONNECTION LINE, POWER

REF	OEM	
PAT85-05000023	6C5-82105-01 6H0-82105-02, J2	-60 hp
REC66T-82105-J2	66T-82105-00, 66T-82105-J2	2,5 m
REC6R3-82105-J3	6R3-82105-J2-00, 6R3-82105-J3	3,5 m



CABLE DE ALIMENTACIÓN

POWER WIRE

REF	OEM	
REC6Y8-83553-02	6Y8-83553-02	12V 8 FT



TIRADOR DE ARRANQUE

STARTER HANDLE ASSY

REF	OEM
PAF4-04130100	6G1-15755-00 6G1-15779-00



PLATO Y PLACA DE ARRANQUE MANUAL

PLATE & DRUM, DRIVE

REF	OEM	2T STROKES	4T STROKES	
PAF15-07130201	63V-15714-00	✓	✓	6 - 20 hp
PAF15-07130001	63V-15716-00	✓	✓	



PAF15-07130201



PAF15-07130001

LLAVES DE ARRANQUE

IGNITION STARTER SWITCH

MONTAJE EN MANDO DE CONTROL

CONTROL BOX

REF	OEM	2T STROKES	4T STROKES
PAF15-13000200W	703-82510-12	✓	✓



LLAVE CON CHOQUE

PUSH T. CHOKE

REF	OEM	2T STROKES	4T STROKES
REC703-82510-44	703-82510-43	✓	✓



LLAVE PARA MANDO POPERO

KEY FOR STERN CONTROL

REF	OEM	2T STROKES	4T STROKES	
REC6H3-82510-03	6H3-82510-00, 01, 02, 03	✓	✓	55B (1992-00) E60H (1996-97) 75A (1992-95) 85A (1995)



SOLENOIDE
RELÉ

SOLENOID
RELAY

REF	OEM	
REC89-825096T01	6E5-81950-01 6G1-81940-00	6 - 90 HP





REF	OEM	
PAF15-05170300W	6G1-81941-10	6 - 90 HP





REF	OEM	
REC63P-81950-00	63P-81950-00	F20 - F300



REF	OEM	
REC68V-81950-00	68V-81950-00	20 - 300 HP





REF	OEM	2T STROKES	4T STROKES	
REC61A-81950-01	61A-81950-00, 01	50 -250 hp (1990-16)	F20, F25 (1998-09)	





REF	OEM	
REC6AW-8194A-00	6AW-8194A-00	F30 / F40 (2009+) F300 (2008-11) F350 (2008+)





REF	OEM	2T STROKES	4T STROKES	
REC6H1-81950-01	6H1-81950-00, 01	✓	✓	30 /40 /45 /50 /60 HP (1995+)



REF	OEM	
REC60E-81950-00	60E-81950-00	30 - 115 HP





REF	OEM	
REC68V-8194A-00	68V-8194A-00 68N-81940-00	F40 - F200 (2000-16) Z / LZ / VZ200 (2004-07) Z / LZ / VZ250 (2003-07) Z / LZ / VZ300 (2004-07)





REF	OEM	
REC6E5-8195A-01	6E5-8195A-01 6E5-8195C-01	100 (1996-01)
		115 (1991-13)
		130 (1991-07)
		150 (1998-07)
		175 (1996-03)
		200 (1991-10)
		225 (1996-09)
		F100 A/AET/TLR/TRZ (1999-06)
		F100 BET (2003-12)
		F100 CETL (2003)
40X/E40MLH (1998-03)		
F80A/AET/TLR (1999-06)		





REF	OEM	2T STROKES	4T STROKES	
REC68F-8195A-00	68F-8195A-00	✓	✓	150 --> 350 HP





REF	OEM	
REC61A-81941-00	61A-81941-00 6E5-81941-11	150
		200
		225
		250
		175
		115
		130
		100HP



REF	OEM	
REC6AW-81950-00	6AW-81950-00	F150C/G (2017+) F1475C (2017+) F200C/G (2013+) F225C/F (2011+) F250B/D/C (2009+) F300A/B/C (2008+) F350A/C/T (2008+)



REF	OEM		
REC60V-81950-00	60V-81950-00	12V	Z250D,T,F (2003-07) Z300A,T (2004-07)



REGULADORES Y RECTIFICADORES

REGULATOR AND RECTIFIERS

YAMAHA

REF	OEM	2T STROKES	4T STROKES	
REC6G1-81970-62	664-81970-60, 61, 62			
	676-81970-00		4 Et 5 HP (1cyl)	
	6E9-81970-70	✓	6, 8, 9.9, 15, 20, 25, 30, 40 (2 cyl)	
	6G1-81970-00, 60, 61, 62, A0		40, 50, 55, 60, 70 (3 cyl)	



REF	OEM	2T STROKES	4T STROKES	
REC6H2-81960-10	6H2-81960-10			40
		✓		50
				60
				70



REF	OEM	2T STROKES	4T STROKES	
PAF15-07060001	6J8-81960-00	✓	✓	6 - 50 HP

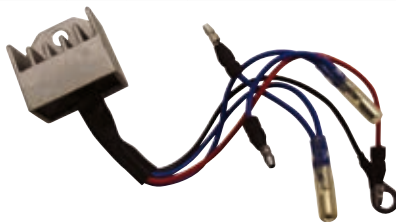

REF	OEM	2T STROKES	4T STROKES	
REC69J-81960-13	64J-81960-10			
	64J-81960-00		✓	F40/F50/F60 (2001 +)



REF	OEM	2T STROKES	4T STROKES	
REC6G8-81960-A1	6G8-81960-A1			F8B (1990-99)
				FT9.9D (1999-08)
		✓		F9.9C/A/B/M (1990-08)
				F13.5A (2005-07)
				F15A/M/E/P (1998-07)



REF	OEM	2T STROKES	4T STROKES	
REC32800-38F10	68V-81960-00 6D3-81960-00			T/FT/F50 (2005-06)
				T/FT/F60C/D/T (2005-06)
		✓		F75B/T (2005)
				F80B (2005-06)
				F100D (2005-06) F115A/T (2000-06)



REF	OEM	2T STROKES	4T STROKES	
PAT85-05030300	6AH-81960-00		✓	F9.9H (2009+)
				F13.5B (2007-09)
				F15C/E/M (2007+)
				F20B/M (2007+)





REF	OEM	2T STROKES	4T STROKES	
REC6G5-81960-A0	6G5-81960-A0			75 (1988-96)
				85 (1989-96)
				90 (1984-91)
		✓		115 (1991-96)
				130 (1988-89)
				150 (1984-89)
				150 (1997)
				175 (1984-89)
				200 (1984-89)





REF	OEM	2T STROKES	4T STROKES	
REC6H0-81960-00	6H0-81960-00	✓		
75A, AEM, AEHD 85A, AE, AED, AEDL, AEDH, AEDX, AET, AETL, AETX E115 A, AE, AEL, AMH, AMHL, AET, AETL, AETX				
693-6922 (1997-02) 688-688F (1997-15) 61U0-61UG (2001-15)				



REF	OEM	2T STROKES	4T STROKES	
REC67F-81960-12	67F-81960-00		✓	
F75AETL (2003) F80A,TLR,TJRA (1999-06) F90AET,TRB,TLRB (2003) F100A,TLR,BET,CET (1999-12)				





REF	OEM	2T STROKES	4T STROKES	
REC6P2-81960-03	6P2-81960-02,03		✓	
F200A/C (2006-15) F225A/B/C (2007-15) F250A/B/T (2006-13)				



REF	OEM	2T STROKES	4T STROKES	
REC68V-81960-10	68V-81960-10, 68V8196010			





REF	OEM	2T STROKES	4T STROKES	
REC69J-81960-13	69J-81960-10, 11, 12, 13		✓	
F200A/T (2003-07) F225A/T (2003-07)				

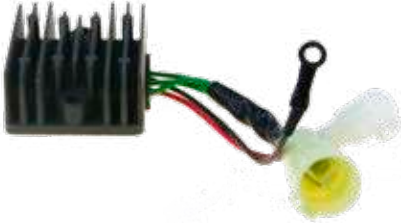

REF	OEM	2T STROKES	4T STROKES	
REC6R3-81960-10	6R3-81960-10	✓		
100A (1991) 115C (1990-13) 130B/T (1990-14) 150C/F/T (1990-13) 175B/D (1990-05) 200B/C (1991-93) PROV200 (1991-94) 225B (1990-91)				





REF	OEM	2T STROKES	4T STROKES	
REC60V-81960-05	60V-81960-00, 01, 02, 03, 04, 05		✓	
250D/F/T (2003-07) 300A/T (2004-07)				



REF	OEM	2T STROKES	4T STROKES	
REC63P-81960-02	63P-81960-00, 01, 02		✓	
F150A,T,B,D,F (2004+)				



REF	OEM	2T STROKES	4T STROKES	
REC61A-81960-04	61A-81960-00, 01, 02, 03, 04		✓	
225C/G (1994-03) 250A/B/E/G (1990-10)				



CDI Y CAJAS NEGRAS

CDI & POWER PACK

YAMAHA

REF	OEM	2T STROKES	4T STROKES	Icon
REC6A1-85540-01	6A1-85540-00, 01	✓		

F9.9C, M (2002-07)
F13.5 A (2002-07)
F155A,E,M,P (2002-07)

REF	OEM	2T STROKES	4T STROKES	Icon
REC68T-85540-00	68T-85540-00		✓	

F6A/B/M (2001-05)
T/FT/F8C/M (2000+)
T/FT/F9.9F/M/J (2008+)

REF	OEM	2T STROKES	4T STROKES	Icon
REC61N-85540-00	61N-85540-00	✓		

25 (1997-07)
30 (1996-08)
200 (1993)

REF	OEM	2T STROKES	4T STROKES	Icon
PAF20-05000300	6AH-85540-00		✓	

F9.9H (2009+)
F13.5 B (2008-09)
F15C/E/M (2007+)
F20B/E/M (2007+)

REF	OEM	2T STROKES	4T STROKES	Icon
REC63V-85540-00-01	63V-85540-00, 01, 02	✓		

9.9, 15HP (1995-08)
13, 5HP (2003-04)

REF	OEM	2T STROKES	4T STROKES	Icon
REC6F5-85540-22	6F5-85540-22	✓		

E40 (2003)

REF	OEM	2T STROKES	4T STROKES	Icon
REC6B4-85540-01	6B4-85540-01	✓		

E9.9 DMH-5 (2003+)
E15 DMH -5 (2003+)

REF	OEM	2T STROKES	4T STROKES	Icon
REC695-85540-11	695-85540-11, 12	✓		

E40 (2003)
9.9 1986-95
15 (1986-95)
20 (1985-02)
25 (1985-02)

REF	OEM	2T STROKES	4T STROKES	Icon
REC695-85540-11	695-85540-11, 12	✓		

REF	OEM	2T STROKES	4T STROKES	Icon
REC695-85540-11	695-85540-11, 12	✓		

REF	OEM	2T STROKES	4T STROKES	
REC66T-85540-00-01	66T-85540-01	✓	40X/E40X MLH XW	(1998+)



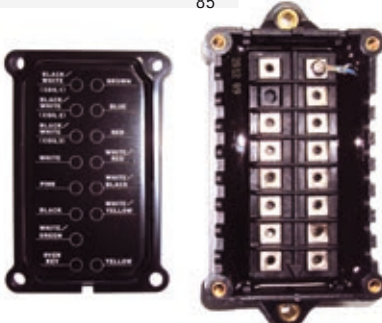

REF	OEM	2T STROKES	4T STROKES	
REC688-85540-16	688-85540-16	✓	75 85	





REF	OEM	2T STROKES	4T STROKES	
REC663-85540-15	663-85540-11, 15	✓	55	(1990-93)





REF	OEM	2T STROKES	4T STROKES	
REC6E5-85540-12	6E5-85540-12, 11,10	✓	115 115 130	(1984-89) (1991-98) (1988-89)





REF	OEM	2T STROKES	4T STROKES	
REC6H2-85540-13	6H2-85540-10, 11, 12, 13	✓	50G (1997-07) 60F,T (1997-10) 70B,T (1997-17)	



REF	OEM	2T STROKES	4T STROKES	
REC6G0-85540-11	6G0-85540-11	✓	175 200 150 225	(1986-89) (1986-89) (1988) (1987-89)



REF	OEM	2T STROKES	4T STROKES	
REC688-85540-00	688-85540-00	✓	E75 BMHD, BMHDL 75 A, AED, AEDL, AEM, AEHD, AET, AETL 75A 85, A, AE, AED, AEDL, AEDX, AEHD, AET, AETX 85A	6925 - 692Y (2003-15) 692 - 692Y (1997-15) 692E (2008) 688 - 688F (1997-15) 6886 - 6887 (2007-08)



DESCONECTORES DE SEGURIDAD

CUT OFF SWITCHES

REF	OEM	
REC688-82575-01	688-82575-01	9.9 --> 250 HP



REF	OEM	
REC65W-82575-01	6E9-82575-00	E30/GE/BMH (1996-12) 25V/M/E/B (1996-10) 6/8C/TRV/MSH (1996-12)



REF	OEM	
REC69W-82575-00	69W-82575-00	



REF	OEM	
PAF4-01090401	682-82556-00	



REF	OEM	
REC66T-82575-01	66T-82575-01	E40X MLHZ X MH (2001+) F2.5
REC65W-82575-01	65W-82575-01	T-F 6-8 F9.9 -F15 9.9F-M F13.5 F25 (2002+)



REF	OEM	
REC6G8-81870-00	6G8-81870-00	F8A-B (1986-99) F9.9A M,E,B (1985-99) 9.9F (1995-2000) 9.9-15-8-6/C-M-D (1984-2002) 9.9D/15D (1985-93)
REC6A0-82550-01	6A0-82550-01	8N/JCEM (1984-96) 6CEM/6DEM (1984-96)



STARTOR

REF	OEM	2T STROKES	4T STROKES	
REC688-85510-01	688-85510-00, 01	✓		E75 BMHD, BMHDL (6925 - 692Y) (2003-15) 75 A, AED, AEDL, AEM, AEHD, AET, AETL (692 - 692Y) (1997-15) 75 A (692E) (2008) 85 A, AE, AED, AEDL, AEDX, AEHD, AET, AETX (688 - 688F) (1997-15) 85 A (6886 - 6887) (2007-08)



REF	OEM	2T STROKES	4T STROKES	
PAF20-05000200	6AH-85510-00		✓	F9.9 (2009+) F13.5B (2007-09) F15C,E,M (2007+) F20B,M (2007+)



TRIM, TILT & POWER TRIM

INSTALACIÓN ELÉCTRICA

KIT CONVERSIÓN
Sustituye de 2 a 3 cables.

REF	OEM
REC84-819514T26	



WIRING HARNESS

CONVERSION KIT
Converts 3-wire Tilt and Trim motors to 2-Wire design

INTERRUPTOR POWER TRIM

REF	OEM	Icon
REC6R3-82563-01	6R3-82563-00 6R3-82563-01	100 - 250 HP

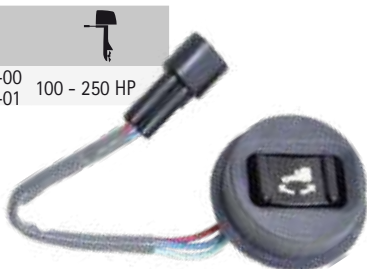

POWER TRIM SWITCH

REF	OEM
PAE4-10040100W	703-82563-00, 01

Para mandos 703
For controls 703



TRIM COMPLETO BIDIRECCIONAL

REF	OEM	Lightning Bolt	Bolt	Wrench	2T STROKES	4T STROKES	Motor Icon
PAT40-10020500	65W-43880-00, 01		4	2		✓	F20AE, AET, DET (1998-15) F25A, AET, AMH, AW, EH, ELH, MHA, DMH, DET (1998-15) F45AET/F50TJR (1999) 25J, JEO, ESH (1999) 30D, DETO, DMH (1999-10) 40X/E40X (1998-03)



REF	OEM	Lightning Bolt	Bolt	Wrench	2T STROKES	4T STROKES	Motor Icon
REC6H1-43880-02	6H1-43880-02	12V	3	2	✓		40HP (1994) 50-90HP (1992-95) 70-90 (1996) 60-70-90 (1998) 90HP (1992-02)



REF	OEM	Lightning Bolt	Bolt	Wrench	2T STROKES	4T STROKES	Motor Icon
REC62X-43880-09	62X-43880-00, 01, 09	12V	3	2	✓	✓	40V (1995-98) F45 (1995-99) 50H (1995-98) F50 (1995-99) FT50 (1996-00)



REF	OEM	Lightning Bolt	Bolt	Wrench	2T STROKES	4T STROKES	Motor Icon
REC6H5-43880-09	6H5-43880-00, 01, 02, 09	12V	4	2	✓		40-50HP (1984-94)



REF	OEM	⚡	🔩	🔗	2T STROKES	4T STROKES	🔧
REC62Y-43880-02	62Y-43880-01, 02 69W-43880-00, 01 CS3-43880-00	12V	3	2	✓	✓	40Y (2005-07) 40V (2003) C40 (2002) F40 (2002) F50 FT50 (2002-07)



REF	OEM	⚡	🔩	🔗	2T STROKES	4T STROKES	🔧
REC6C5-43880-01	6C5-43880-00, 01		3	1	✓	✓	F40 (2006-10) F60 (2006-10) F50 (2005-10) FT60 (2006-10) 40-50HP (1985-92)



REF	OEM	⚡	🔩	🔗	2T STROKES	4T STROKES	🔧
REC6H1-43880-00	6H1-43880-00	12V	3	2	✓		60F (1987-91) 70B (1987-91) 75A (1990-91) 80A (1987-91) 85A (1990-91) 90A (1987-91)



+ relés conversión | relay |

REF	OEM	⚡	🔩	🔗	∅	2T STROKES	4T STROKES	🔧
REC688-43880-11	688-43880-11 6E5-43880-00, 01, 02	12V	3	3	68,3 mm	✓		60 70 75 80 85 90 115 150 200HP

📏 4 mm



REF	OEM	⚡	🔩	🔗	2T STROKES	4T STROKES	🔧
REC6D8-43880-09	6D8-43880-00, 09	12V	4	2		✓	F75TR,TLR,BET (2005) F80AET,BET (2005-06) F100AET,DET (2005-06) EJE LARGO LONG SHAFT



REF	OEM	⚡	🔩	🔗	2T STROKES	4T STROKES	🔧
REC67F-43880-00	67F-43880-00	12V	4	2		✓	F75 (2003-04) F80 (1999-05) F90 (2003-04) F100 (1999-05)



REF	OEM				2T STROKES	4T STROKES	
REC6G5-43880-02	6G5-43880-00, 01, 02	12V	3	2	✓		115-200 (1987-95) 225 (1990-94)



REF	OEM				2T STROKES	4T STROKES	
REC63P-43880-22	63P-43880-10 63P-43880-11 63P-43880-12 63P-43880-22	12V	3	2		✓	F150A/B/C/D/F/G (2012+) F175A,C (2018+) F200B,C,F,G (2018+)



REF	OEM				2T STROKES	4T STROKES	
REC69J-43880-01	69J-43880-00, 01 60V-43880-00		3	2			F200 F225 (2002+) F250 (2005+) Z300



REF	OEM				2T STROKES	4T STROKES	
REC61A-43880-02	61A-43880-00, 01	12V	3	4	✓		225 250HP



REF	OEM				2T STROKES	4T STROKES	
REC67H-43880-10	6AE-43880-00, 01, 03, 04 68W-43880-03 67H-43880-00	12V	4	2	✓		225 250HP 115 225 (1997-02)



REF	OEM				2T STROKES	4T STROKES	
REC6AW-43880-22	6AW-43880-00, 01, 02	12V	2	2		✓	F300A (2008-11) F350A (2008+)



REF	OEM				2T STROKES	4T STROKES	
REC6AW-43880-22	6AW-43880-00, 01, 02	12V	2	2		✓	F300A (2008-11) F350A (2008+)



POWER TRIM COMPLETO

COMPLETE POWER TRIM ASSEMBLY

REF	OEM	2T STROKES	4T STROKES	
PAT40-10000000	65W-43800-02-4D			
	65W-43800-03-4D			
	65W-43800-21-4D			
	65W-43800-22-8D	✓	✓	F20 / F25
	65W-43800-23-8D			E40 / 40X
	65W-43800-20-4D			30D
	65W-43800-01-4D			
	65W-43800-00-4D			



REF	OEM	2T STROKES	4T STROKES	
PAF60-06000000	6C5-43800-11, 12		✓	F40/ F50/ F60 (2016+)



REF	OEM	2T STROKES	4T STROKES	
REC6H1-43800-17-8D	6H1-43800-17-8D			
	6H1-43800-16-4D			
	6H1-43800-15-4D	✓		50 - 90 HP
	6H1-43800-13-4D			
	6H1-43800-14-4D			

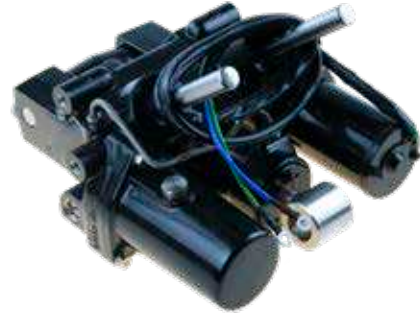

DESPIECE PISTÓN TRIM

PISTON TRIM PARTS

REF	OEM			UN.
1 REC48630-96J03	64E-43821-00, -05	TORNILLO CILINDRO	SCREW	2
	64E4382100	EXTREMO		
	64E4382105			
REC48630-96J03	64E-43821-08, 09, 00	TAPÓN PARA	CAP FOR SHOWA SYSTEM	2
	64E-43820-08, 09, 00	SHOWA SYSTEM		
	6AW-4380R-00			
2 REC64E-43822-00	64E-43822-00	SELLO	SEAL OIL	2
3 REC64E-4384J-00	64E-4384J-00	SELLO	SEAL OIL	2
4 REC6G5-43864-00	6G5-43864-00	SELLO	SEAL OIL	2

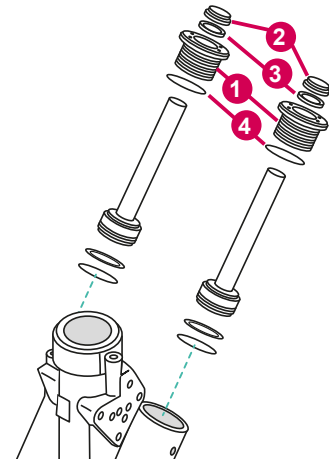

TAPONES TRIM

TRIM PLUGS

REF	OEM
REC48630-96J03	64E-43821-00
	64E-43821-05
	64E4382100
	64E4382105



SISTEMA DE GOBIERNO

STEERING SYSTEM

MANDOS DE CONTROL

MANDO LATERAL (703) PUSH TO OPEN



Leva para aceleración en punto muerto. Utiliza cables 33-C



ENGINE CONTROLS

SIDE CONTROL (703) PUSH TO OPEN

Lever for neutral engine warm-up. For 33-C cables

REF	OEM		
	703-48230-10		
	703-48230-11		
	703-48230-12		
	703-48230-13		
	703-48230-14		
REC703-48230-14	703-48230-15	9.9 - 70 HP (1986+)	7
PAF15-13000000W	703-48230-16		
	703-48230-17		
	703-48230-18		
	703-48230-1A		
	703-48230-20		
	703-48230-21		

Leva para aceleración en punto muerto. Con interruptor y cableado de Power Trim. Utiliza cables 33-C. Dual function, single lever control with power trim switch and wires. For 33-C cables.

REF	OEM	POWER TRIM	
	703-48205-10		
	703-48205-11		
	703-48205-12		
	703-48205-13		
	703-48205-14		
REC703-48205-16	703-48205-15	8 - 300 HP (1984+)	✓ 10
PAT85-08010000W	703-48205-16		
	703-48205-17		
	703-48205-18		
	703-48205-1A		
	703-48205-1B		
	703-48205-20		
	703-48205-21		



MANDO LATERAL PULL TO OPEN

REF
PAF40-13000000E

SIDE CONTROL PULL TO OPEN



REF	OEM	
REC703-48272-12	703-48272-12	10
REC703-48272-12-00	703-48272-12-00	10



REF	OEM	
REC703-48203-23	703-48203-12-00, 703-48203-23	7
REC703-48230-22	703-48230-12, 703-48230-22	7



REF	OEM	STOP
REC6X3-48206-22	6X3-48206-21, 6X3-48206-21-00	✘



**MANDO EMPOTRADO
PUSH TO OPEN 6X3**

REF	OEM
REC6X3-48206-11	6X3-48206-11
	6X3-48206-10
	6X3-48206-03
	6X3-48206-02
	6X3-48206-01



**FLUSH MOUNT
PUSH TO OPEN 6X3**

REF	OEM	
REC703-48207-24	703-48207-17, 703-48207-24	10



REF	OEM	
REC703-48230-14-P	703-48230-14-P	7



REF	OEM	
REC703-48206-22	703-48206-21, 703-48206-22	10



PUSH TO OPEN

REF	OEM
PAF15-13000500W	703-48261-101



PULL TO OPEN

REF	OEM
PAT20-13000500W	703-48261-11



MANDO PARA CONSOLA

REF	YAMAHA 704	TRIM
REC704-48205-R0	704-48205-R0	
	704-48205-P1	
	704-48205-B1	
	704-48205-B0	
	704-48205-R0	
	704-48205-14	✓
	704-48205-11	
	704-48205-12	
	704-48205-13	
	704-48205-15	
704-48205-P0		



CONSOLE CONTROL

REF	YAMAHA 704	TRIM
REC704-48207-R0	704-48207-R0	
	704-48207-P1	
	704-48207-39	
	704-48207-31	✓
	704-48207-30	
	704-48207-20	
	704-48207-21	
	704-48207-22	



CONECTORES DE CABLES

REF	OEM	Image
REC663-48344-00	663-48344-00	6>115HP



CABLE CONNECTOR

REF	OEM	Image
PAF25-07000007W	703-48345-01	6>115HP



KIT ADAPTACIÓN

REF	OEM	Image
REC6DR-48501-03	68R-48501-00-00, 6AU-48501-00-00, 6DR-48501-00-00	F6A/F6B/F8C/FT8D/F8F/FT8G/ F9.9F/F9.9J/FT9.9G/FT9.9L

ADAPTATION KIT



KIT ACCESORIOS DE CONTROL REMOTO

REMOTE CONTROL ACCESSORIES KIT

REF	OEM	
REC6AH-48501-02	6AH-48501-00-00	F15C/F20B



REF	OEM	
REC6G8-48501-03-00	6G8-48501-03-00	F8A/F8B/F9.9A/F9.9B/FT9.9A



REF	OEM	
REC6J8-48501-03-4D	6J8-48501-00-00 6J8-48501-03-4D	25J/30D



REF	OEM	
REC6L2-48501-11-00	6L2-48501-11-00	20D/25N



REF	OEM	
REC6J8-48501-11	6J8-48501-11 6J8-48501-11-00	25J/30D



REF	OEM	
REC689-48501-50-00	689-48501-50-00	30E



REF	OEM	
REC66T-48501-02	66T-48501-02	E40M/E40X/40X



REF	OEM	
REC63V-48501-00	63V-48501-00	9.9F/9.9M/15F/15M/13.5A



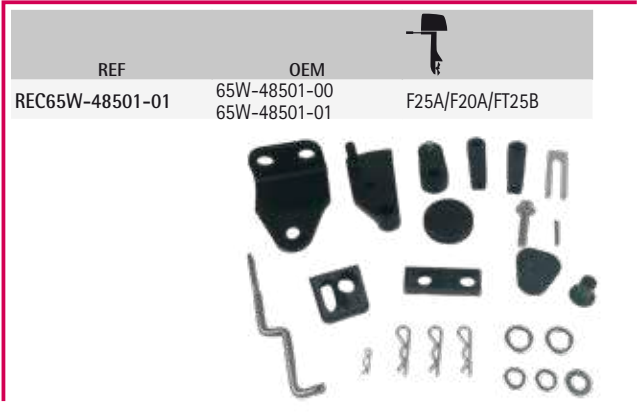
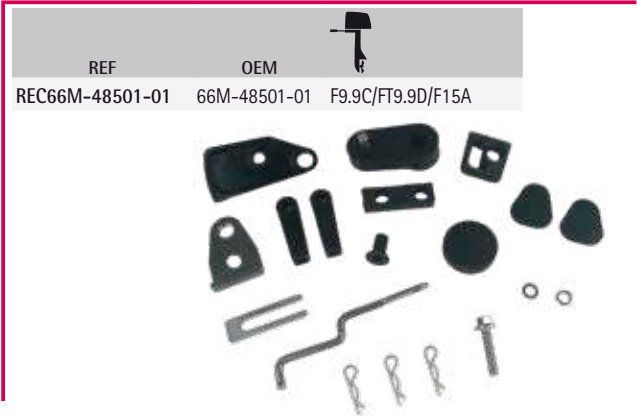

KIT ACCESORIOS GUÍA DE DIRECCIÓN

STEERING GUIDE ACCESSORIES KIT



INTERRUPTORES PARA MANDOS

SWITCHES FOR ENGINE CONTROLS

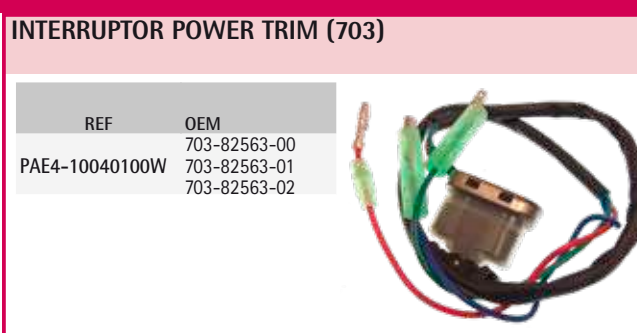

INTERRUPTOR PANEL COMPLETO O DOBLE ESTACIÓN

PANEL TWIN STATION

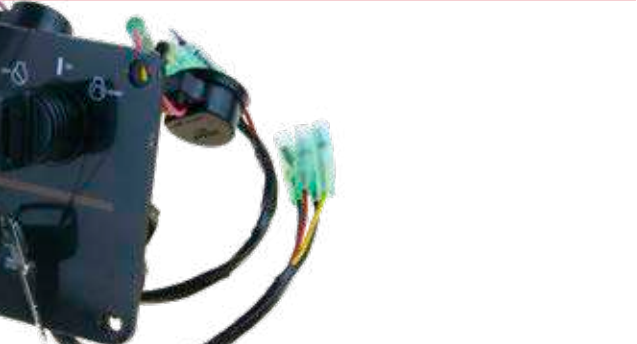

**ZUMBADOR ACÚSTICO
(703)**

REF	OEM
PAF15-13000300W	703-83383-00
	703-83383-01
	703-83383-02
	703-83383-10
	703-83383-11



**BUZZER ASS'Y
(703)**

INTERRUPTOR PANEL SIMPLE (704)

REF	OEM
REC704-82570-12	704-82570-12
	704-82570-11
	704-82570-10
	704-82570-08
	6E5-82570-05



**SWITCH
(704)**

REF	OEM
REC704-82563-42	704-82563-42
	704-82563-41
	704-82563-40



REF	OEM
REC704-82563-J2	704-82563-J2
	704-82563-J1
	704-82563-J0



PANEL INTERRUPTOR

REF	OEM
REC64D-82570-31-00	64D-82570-31-00



SWITCH PANEL

REF	OEM
REC6X6-82570-50-00	6X6-82570-50-00



REF	OEM
REC6K1-82575-01	6K1-82575-00-00 6K1-82575-01



REF	OEM
REC6X6-82570-A0-00	6X6-82570-A0-00



KIT INTERRUPTOR DE TRIM

REF	OEM
REC6H1-82563-11-00	6H1-82563-11-00



TRIM SWITCH

REF	OEM
REC6X0-82563-02	6X0-82563-01-00 6X0-82563-02



REF	OEM
REC704-82563-31-00	704-82563-31-00



REF	OEM
REC704-82563-52	704-82563-52/00



REF	OEM
REC704-82563-H2-00	704-82563-H2-00



ARNÉS

ARNES

EXTENSIÓN DE ARNÉS (703/704)

REF	OEM		
REC688-8258A	688-8258A-10	2 m	10
REC688-8258A-30	688-8258A-30	3 m	10



ARNES EXTENSION (703/704)

ARNÉS COMPLETO (703)

REF	OEM		
PAF15-13000100W	688-82586-21	5 m	7
PAT85-08010100	688-8258A-20	5 m	10





PAF15-13000100W



PAT85-0801010

EXTENSIÓN DE ARNÉS

HARNESS EXTENSION

REF	OEM		
REC61B-8258A-01	61B-8258A-00-00 61B-8258A-01	9,5 m / 31FT	10
REC6K1-8258A-40-00	61A-8258A-00-00 6K1-8258A-40-00	26,2 FT	10
REC688-8258A-50-00	688-8258A-50-00	5 m	10
REC688-8258A-60	688-8258A-60 6X3-8258A-10-00	6 m	10
REC688-82586-11	688-82586-11 688-8258A-10-07	2 m	7
REC688-82586-32	688-82586-32 688-8258A-30-07	3 m	7
REC688-82586-51	688-82586-51 688-8258A-50-07	5 m	7



REC61B-8258A-01
REC6K1-8258A-40-00



REC688-8258A-50-00
REC688-8258A-60



REC688-82586-11
REC688-82586-32



REC688-82586-51

REF	OEM	
REC6X6-8258A-41	6X6-8258A-41	12FT
REC6X6-8258A-71	6X6-8258A-71	15FT
REC6X6-8258A-61	6X6-8258A-60 6X6-8258A-61	17FT
REC6X6-8258A-11	6X6-8258A-10 6X6-8258A-11	23FT
REC6X6-8258A-81	6X6-8258A-81	24FT
REC6X6-8258A-31	6X6-8258A-30 6X6-8258A-31	32FT
REC6X6-8258A-21	6X6-8258A-21	8/26FT



REF	OEM	
REC688-82590-00	688-82590-00	85



COMPONENTES (703)

ESPACIADOR

REF	OEM
PAF15-1100002W	703-48293-10



PALANCA ACELERADOR

REF	OEM
PAF15-13020007W	703-48152-00



COMPONENTS (703)

PLATE CONTROL BOX

THROTTLE HANDLE INCHING

CABLE DE ACELERADOR

REF	OEM	
REC6E0-26301-01	6E0-26301-01	4AC/A/AS 5C/CS/CMH



REF	OEM	
REC677-26301-02	677-26301-02	E8D E8DMH



REF	OEM	
REC6L2-26301-00	6L2-26301-00	9.9F/FM 13.5AM 15F/FM 20D/M 25N/NE/ NW/D/M



REF	OEM	
REC66T-26301-00	66T-26301-00	40X/E40X



THROTTLE CABLE

REF	OEM	
REC6B4-26301-00	6B4-26301-00	E15D E9.9D



REF	OEM	
REC61N-26311-00	61N-26311-00	25B/BM/V 30G/E30H



REF	OEM	
REC6F5-26311-00	6F5-26311-00	E40G/J 40G/J



REF	OEM	
REC692-26301-03	692-26301-00, 01,02,03	55B (1992-00) 75A (1992-00) 85A (1995-98) E75B (2003-16) E48C (2003) E60H (2001+) E55C (2003-16) F40J (2016+)

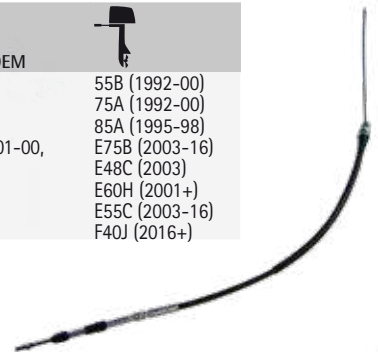

PLACA CERRADURA SELECTOR

BLOCK CONTROL HANDLE

REF	OEM
PAF15-13010010W	703-48245-00



RUEDA ACCELERACION

LEVER THROTTLE

REF	OEM	
REC663-42138-00	663-42138-00	55B/BET E55 E60 75A5 85AE



MANETA ACELERADOR

LEVER, THROTTLE

REF	OEM
PAF4-01090100	6G1-42138-00,01 6EG-G2138-00



REF	OEM
PAF15-01030100	65W-42138-00



VARILLA DE ENLACE

LINK ROD ASSY

REF	OEM	
PAF15-11020000W	63V-61350-00	9.9F 15F F9.9C F19.9D F15A



REF	OEM	
PAF20-07000100W	63AH-61350-00	F15C F20B



BRACKET

BRACKET ESTRIBOR

RIGHT BRACKET ASSY

REF	OEM	2T STROKES	4T STROKES	
PAF15-01010200	63V-43112-00-4D			9.9
	63V-43112-01-4D			13.5
	63V-W4311-00-4D	✓	✓	15
	63V-W4311-03-4D			
	63V-WS431-B6-8D			



BRACKET BABOR

LEFT BRACKET ASSY

REF	OEM	2T STROKES	4T STROKES	
PAF15-01010100	63V-43111-00-4D			9.9
	63V-43111-01-4D	✓	✓	13.5
	63V-43111-A2-4D			15



SOPORTE GIRATORIO

BRACKET, ROTARY

REF	OEM	2T STROKES	4T STROKES	
PAF15-01010301S	63V-43311-00-4D			9.9
	63V-43311-01-4D	✓	✓	13.5
	99999-03116			15



RETÉN INFERIOR DEL BRACKET

BRACKET OIL SEAL

REF	OEM	2T STROKES	4T STROKES	
REC93109-44M00	93109-44M00	✓		40 HP



**ENGRASADOR INOX 316
M6**

OILER M6

REF	OEM
PAJB/T9740.1-M6	93700-06M03



SOPORTE BARRA DE DIRECCIÓN

BOLT, CLAMP BRACKET

REF	OEM	2T STROKES	4T STROKES	
PAF15-01010001	63V-43131-00			9.9 - 60 Hp
	63V-43131-10	✓	✓	
	63v-43131-01			



REF	OEM
PAF15-01010007	63V-43145-00
	90185-22043
	90185-22M11



SOPORTE INFERIOR

SHELL, MOUNT DAMPER

REF	OEM	
PAF15-00000001	66M-44551-00-4D	9.9
	63V-45551-00-4D	13.5
		15



VARILLA DE BASCULACIÓN

TILT ROD

REF	OEM	
REC676-43160-02	676-43160-00	40 - 55 HP
	676-43160-01	
	676-43160-02	



REF	OEM	
REC688-43160-01	688-43160-01	40 - 90 HP



CIRCLIP

REF	OEM	
PAGB/T896-9	93430-10M00	6L5
	99080-10600	



EJE CONECTOR ACELERADOR

THROTTLE SHAFT CONNECTOR

REF	OEM
REC688-41211-01	688-41211-00 688-41211-01



CONECTOR

CONNECTOR

REF	OEM
REC682-41237-00	682-42137-00
REC682-41237-50	682-41237-50
REC663-85518-00	633-85518-00



REC682-41237-00



REC682-41237-50



REC663-85518-00

COLLAR

WASHER, BELOW

REF	OEM
PAF15-01000006	90386-30M60
PAT85-01020003	90386-30M78



PAF15-01000006



PAT85-01020003

BUJES

BUSHINGS

REF	OEM
PAF15-01010302	90386-22M15
REC90386-25M31	90386-25M31
PAF15-01000004	90386-30048
PAF25-01000004	90386-44M03
PAF25-01000001	90386-52M02
REC90386-30M77	90386-30M77



PAF15-01010302



REC90386-25M31



PAF15-01000004



PAF25-01000004



PAF25-01000001



REC90386-30M77

REF	OEM	
REC90386-22M13	90386-22M13	NYLON
PAT85-01010203	90386-10M16	NYLON
PAT85-01020005	90386-30M77	NYLON
PAT85-00000017	90386-18M35	NYLON
REC90386-18M63	90386-18M63	NYLON
REC90386-22M98	90386-22M98	NYLON
REC90381-20001	90381-20001	NYLON
REC90386-38M89	90386-38M89	NYLON
PAF15-01000001	65F-42537-00	NYLON
PAF25-03000007	90387-06M69	METAL



REC90386-22M13



PAT85-01010203



PAT85-01020005



REC90386-18M63



REC90386-22M98



REC90381-20001



REC90386-38M89



PAT85-00000017



PAF15-01000001



PAF25-03000007

MANDO ACELERADOR

STEERING HANDLE ASSY

REF	OEM	
PAF4-01090300	68D-G2177-10 6EE-G2177-00	F4-F8



REF	OEM	
REC6N0-G2177-00	6N0-G2177-00	F2.5 6C/T/M/D 8C/T/M



EJE DE CAMBIO

REF	OEM	
REC688-44120-12	688-44120-11 688-44120-12	75AE/A E75B 85A/AE



REF	OEM	
REC688-44120-22	688-44120-22	85AE



HANDLE GEAR SHIFT ASSY

REF	OEM	
REC692-44120-22	692-44120-21 692-44120-22	75AE 80A 90A 90ETN



MANETAS Y FIJACIONES

REF	OEM	
REC6L8-G3118-01	6L8-G3118-01	F4/F6/F-FT8/F6 6C/TRV/M/D 8C/M



REF	OEM
REC99999-02808	99999-02808



REF	OEM
REC6E0-43118-01	6E0-43118-00 6E0-43118-01



REF	OEM	
REC663-43118-01-4D	663-43118-01-4D	F20/F25 40X/E40M/E40X/40Q E8D/55B E60H/E E55C E9.9D/E15D



STARTER HANDLE AND FIXINGS

REF	OEM	
REC648-44146-00	648-44146-00	25Q/D 30A 20C 40Q/H/E40G/J 50D



REF	OEM	
REC689-15755-00	689-15755-00	9.9D/15D 25NE/20DM



REF	OEM	
REC650-44147-00	650-44147-00	40Q E40G/J 40G/J



SILENBLOCK

REF	OEM	
PAF15-00000002	682-44555-30	6 HP 8 HP 9.9 HP 15 HP



REF	OEM	
REC676-44518-00	676-44518-00	E40G/J 40G/J 40G





REF	OEM	
REC682-44514-01-94	682-44514-01-94	E9.9DMH E15DMH



REF	OEM	
REC670-44555-00-94	62Y-44555-00	E48CM E55CM





REF	OEM	
PAF15-00000003	66M-44557-00	9.9 HP 13.5 HP 15 HP



REF	OEM	
REC663-44551-02-8D	663-44551-02-8D	F50DETL 75CETO 90AETO/TR/TRH



REF	OEM	
PAF15-02010000	66M-44514-00-4D	9.9 HP 13.5 HP 15 HP



REF	OEM	
REC670-44514-00	670-44514-00	55B E55CMH



REF	OEM	
REC66T-44514-00-4D	66T-44514-00-4D	40X E40X/M





REF	OEM	
REC688-44514-00	688-44514-00	E60HMHD 70BETO 75CETO 90AETO



REF	OEM	
REC679-44514-00-94	679-44514-00-94	40QE/QWC/G/J E40G/J



REF	OEM	
REC688-44555-00	688-44555-00	60FE/FET 70CE/ETN E75B 80A 85A



TORNILLO SUPERIOR **UPPER SCREW**

REF	OEM	
REC90109-08262	90109-08262	55B E55C



SISTEMA DE REFRIGERACIÓN

COOLING SYSTEM

TERMOSTATO

THERMOSTAT

TERMOSTATO

REF	OEM	°C
REC6DA-12411-01	6DA-12411-01	60°



REF	OEM	°C
REC6AH-12411-00	69M-12411-01	60°
	69M-12411-00	
	6AH-12411-00	



REF	OEM	°C
REC6FM-12411-00	6FM-12411-00	60°



REF	OEM	°C
REC6E5-12411-02	6E5-12411-00	50
	6E5-12411-01	
	6E5-12411-02	



REF	OEM	°C
REC6D9-12411-00	6D9-12411-00	55°



REF	OEM	°C
REC6CE-12411-00	6CE-12411-00	52°



REF	OEM	°C
REC6AW-12411-00	6AW-12411-00	60°



THERMOSTAT

REF	OEM	°C
REC6FP-12411-00	6FP-12411-00	60°



REF	OEM	°C
REC6F5-12411-03	6F5-12411-00	60°
	6F5-12411-01	
	6F5-12411-02	
	6F5-12411-03	



REF	OEM	°C
REC6E5-12411-30	6E5-12411-30	50°
	6E5-12411-20	
	6E5-12411-10	



REF	OEM	°C
PAF15-07000031	66M-12411-00	60°
	66M-12411-01	



REF	OEM	°C
REC6H3-12411-10	6H3-12411-00	60°
	6H3-12411-01	
	6H3-12411-10	
	6H3-12411-11	



REF	OEM	°C
REC67F-12411-01	67F-12411-00	60°
	67F-12411-01	



REF	OEM	°C
REC60V-12411-00	60V-12411-00	50°



GUÍA TERMOSTATO

THERMOSTAT GUIDE

	REF
3A/ 4A/ 5C/ 6C/ 8C/ 25N (-1993)/ 25NWO	REC6E5-12411-02
9.9F/ 15F/ 25N(1994+)/30D/ 40V/ 75C/ 90A/ 100A/ 115C/ 130B/ 150F/ 175D/ 200F/G/ 225D/G/ 250A/B/ Z150P/Q/ Z175G/ Z200N/P	REC6E5-12411-30
F2.5A/ F9.9H/ F13.5B/ F15C/ F20B,M	REC6AH-12411-00
9.9D/ 15D/ 20C/ 25D/ 40Q/ 55B	REC6F5-12411-03
F15C/F20D	REC6AH-12411-00
F25G	REC6FM-12411-00
50G/ 60F/ 70B	REC6H3-12411-10
F4A/B/ F5A/ F6A/C/ F8B/C/ FT8D/ F9.9B/C/F/J/ FT9.9A/D/G/L/ F15A/ F25A/D/ FT25B/F/ F30A/B/ F40A/B/F/ F50A/F/H/ FT50B/ PAF15-07000031 C/G/J/ F60A/C/F/ FT60B/D/G/ F70A/ F80A/ F100A(2000-)	

	REF
F80A/B/ F100A(01+)/ F100B/ F(L)150A/ F(L)200A/C/ F(L)225A/B/C/ F(L)250A/B	REC67F-12411-01
F100D	REC6D9-12411-00
F100F	REC6FP-12411-00
F(L)225F/ F(L)250D/ F(L)300B	REC6CE-12411-00
F(L)200F/ F(L)200G/ F175A	REC6DA-12411-01
F(L)300A/ F(L)350A	REC6AW-12411-00
F100B/ F(L)115A/ (L)Z250D/F/ Z300A	REC60V-12411-00

JUNTAS TERMOSTATO

THERMOSTATO GASKETS

REF	OEM		
REC63P-12414-00	63P-12414-00	F150A/B/D/F/T (2004+)	

REF	OEM		
PAF4-04000011	68D-E2414-A0	F2.5 F4 F5 F6	

REF	OEM		
REC6G8-12414-A0	6G8-12414-A0	T8/T9.9 F6/8/9.9 FT8/9.9	

REF	OEM		
REC6H3-12414-A1	62Y-12414-00 6H3-12414-A1	F9.9, F30 F60, F13.5 F70 FT9.9 T9.9TLR FT25, FT50 FT60	

REF	OEM		
REC61A-12414-A0	61A-12414-A0	20DM/MSH 25J/JETO/NEM/NWC/D/DM 30D/DMH 40V/VMH/VEO C40MLH/T 50H/HM 225C/CET/FETO/G 250AET/B/TXR/G/GETO	

REF	OEM		
REC682-12414-A1	682-12414-A1	9.9D/F/FMH/FEMH/MH/MSH 15D E9.9DMH, E15DMH 13.5AMH 15F/FEMH/FMH/MSH/MH	

REF	OEM		
PAF20-05000702	6AH-12414-00	F9.9 -F20 (New models)	

REF	OEM		
REC655-12414-A1	655-12414-A1	20C/CM E25A, E25BMH, E30HMH 25VE/VM/DE/D/B/BMH/BWH/HMH 30G/GE/A, 30HMH/HWH/HWL	

REF	OEM		
REC676-12414-A0	676-12414-A1	40X/E40X/E40MLH	

REF	OEM	
REC6E9-12414-A1	6E9-12414-A1	40QE/QM/QEZ/QWC/GWH/JWH E40GMH/JMH



REF	OEM	
REC688-12414-A1	688-12414-A1	75CETO/AE, E75B 80AE/A, 85AE/A 90AE/TLR, 100A/TLR 115BE/B, 115A/AETO/CET 130BETO/TLR 150F/TXRA/FETO/C, Z150 175D/DETO/DETO, Z175 225D/DETO VZ200, Z200 200AET/CETO/F/FETO/G/GETO



REF	OEM	
REC663-12414-00	663-12414-A0	E48CMHS 55B/BET/BE/BM E55CMH



CUBIERTAS TERMOSTATO **THERMOSTATO COVER**

REF	OEM		
REC6E9-12413-00-1S	6E9-12413-00-1S	REC6E9-12414-A1	E40/40J (2003+)



REF	OEM		
REC682-12413-00-1S	682-12413-00-1S 682-12413-00-9M	REC682-12414-A1	E40/40J (2003+)



REF	OEM	
REC688-12413-00-1S	688-12413-00-1S	REC688-12414-A1



VÁLVULA ANTIPRESIÓN DE TERMOSTATO **THERMOTAT, PRESSURE VALVE**

REF	OEM	O-RING	OEM
REC688-12416-00	688-12416-00	REC90480-20M05	90480-20M05



RESORTE **SPRING**

REF	OEM	
REC90501-16M11	90501-16M11	75 / 85 / 90A

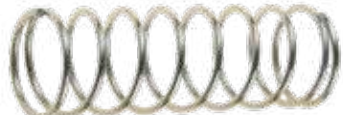

NIPLE

REF	OEM
PAF15-05000009	6H3-44391-00 6H3-44391-01 6BL-44391-00



NIPPLE

REF	OEM
REC6EE-G4366-01	6EE-G4366-01



JUNTAS TAPA DE REFRIGERACIÓN

REF	OEM	
REC6E0-41114-A1	6E0-41114-A1	4AC/AS/MSH 5C/CS

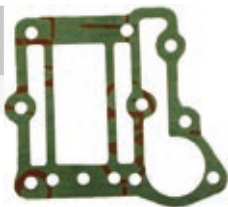

GASKET, EXHAUST INNER COVER

REF	OEM	
REC6B4-11193-A0	6B4-11193-A0	E9.9 / E15 (2003+)

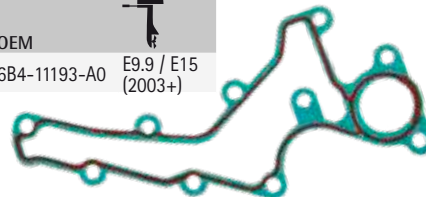

REF	OEM	
REC6E0-41112-A1	6E0-41112-A1	4AC/AS/MSH 5C/CS

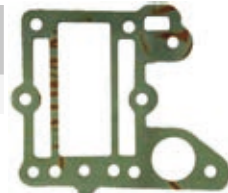

REF	OEM	
REC682-41112-00	682-41114-A1	9.9D 15D



REF	OEM	
REC6G1-41112-A1	6G1-41112-A1	6C/T/M/D 8C/M/T

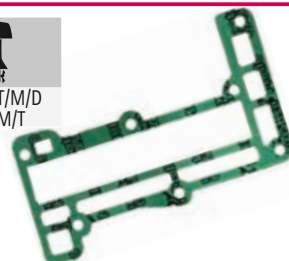

REF	OEM	
REC682-41112-00	682-41112-A1	9.9D 15D



REF	OEM	
REC6G1-41114-A0	6G1-41114-A0	6C/T/M/D 8C/M/T

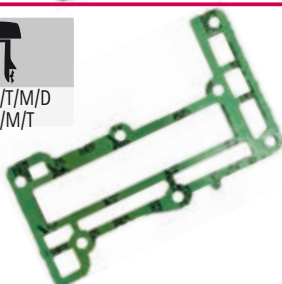

REF	OEM	
PAF15-07010018	66M-41114-01	F9.9 13.5 F15



REF	OEM	
REC6G1-11193-A1	6G1-11193-A1	6C/M/T/D 8C/M/T



REF	OEM	
REC63V-41112-A0	63V-41112-A0	9.9F/MSH/MH 13.5AW 15F/MSH/MH E15DMH



REF	OEM	
REC677-41112-A0	677-41114-A0	E8D/DMH



REF	OEM	
REC664-41114-A0	664-41114-A0	20C/25D

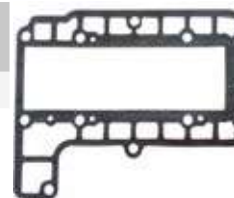

REF	OEM	
PAF25-05010111	65W-41114-00	F20/25 T25

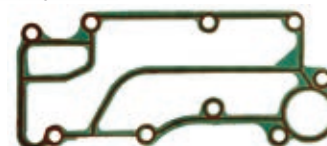

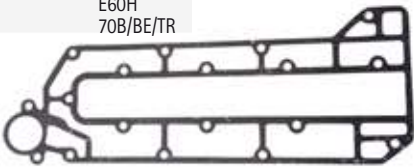

REF	OEM	
REC6H3-41112-A0	6H3-41112-A0	25B 50G/GE 60FE/TLR E60H 70B/BE/TR



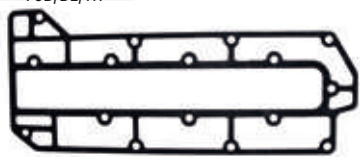

REF	OEM	
REC6H3-41114-A0	6H3-41114-A0	25B 50G/GE 60FE/TLR E60H 70B/BE/TR



REF	OEM	
REC6H4-41114-A0	6H4-41114-A0	25QE0 40H/V/E/TLR C40M/T 50H/DE



REF	OEM	
REC6K8-41122-A1	6K8-41122-A1	25VE/M/B/BMH E25A 30HM/HW/G/GE E30HMH



REF	OEM	
REC6K8-41124-A1	6K8-41124-A1	25VE/M/B/BMH E25A 30HM/HW/G/GE E30HMH

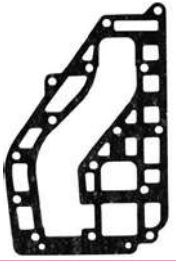

REF	OEM	
REC6K8-41124-A1	6K8-41124-A1	25QE0 40H/V/E/TLR C40M/T 50H/DE

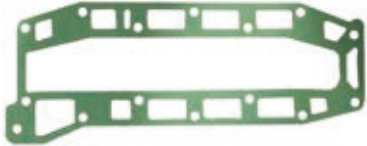

REF	OEM	
REC689-41112-A0	689-41112-A0	30A





REF	OEM	
REC689-41114-A0	689-41114-A0	30A

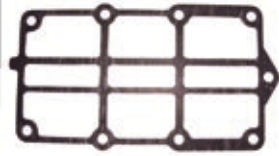

REF	OEM	
REC66T-41114-A0	66T-41114-A0	40X E40X



REF	OEM	
REC6F5-41112-A0	6F5-41112-A0	40GWH/JMH E40GMH



REF	OEM	
REC6F5-41114-A0	6F5-41114-A0	40GWH/JMH E40GMH

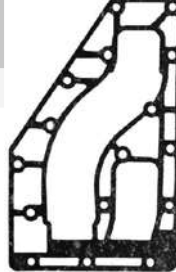

REF	OEM	
REC663-41114-00	663-41114-A0	55B E55CMH

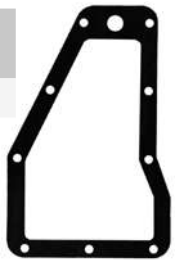

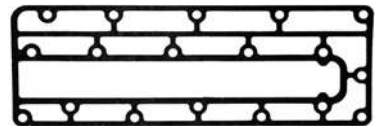

REF	OEM	
REC688-41112-A0	688-41112-A0	75CET/TLR/AE E75B 80AE 85A/AE 90A/AE/TLR

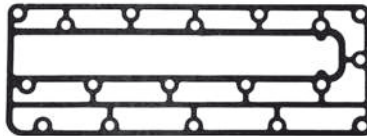

REF	OEM	
REC688-41114-A0	688-41114-A0	75CET/TLR/AE E75B 80AE 85A/AE 90A/AE/TLR



REF	OEM	
REC6G5-41112-A1	6G5-41112-A1	150F/FE/TXR/GE/A-CE, 175D/DE/FE 200AET/F/FE/TLR/G/GE/BE 225D/DE/BE



REF	OEM	
REC6E5-41112-A1	6E5-41112-A1	100A/AET/TLR 115B/BE/TLR/CEO/TXR 130BET/TLR

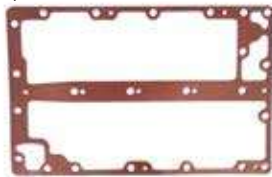

REF	OEM	
REC6G5-41112-A1	6G5-41114-A0	150F/FE/TXR/GE/A-CE, 175D/DE/FE 200AET/F/FE/TLR/G/GE/BE 225D/DE/BE

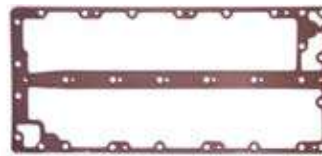



REF	OEM	
REC6G5-11382-A1	6G5-11382-A1	115HP-250HP



KITS DE JUNTAS

GASKETS KIT

REF	OEM	
REC6E0-W0001-C1	6E0-W0001-C1	F4/F5/F6 4C MSH 5C/CS/CMH



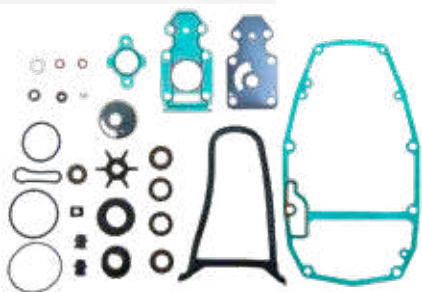

REF	OEM	
REC66M-W0001-20	66M-W0001-20	F9.9, F13.5, F15





REF	OEM	
REC6G1-W0001-C1	6G1-W0001-C0	6C/CMH/MSH/TRV/D/DMH 8C/MSH/CMH/TRV



REF	OEM	
REC6H3-W0001-22	6H3-W0001-22	25B/BETO 50G/GEO/GETO 60FETO/FEDO/FEO/F/TLR 70B/BETO/BEMO





REF	OEM	
REC62Y-W0001-22	62Y-W0001-20,-21,-22	F40A, ELH/F45AE, AET/F50A, AET, AED, AEDH, AEHT, TJR, TJRB, TLR, TLRA, TLRC, TLRZ, TLHC/FT50B/T50TLR (2000-07)

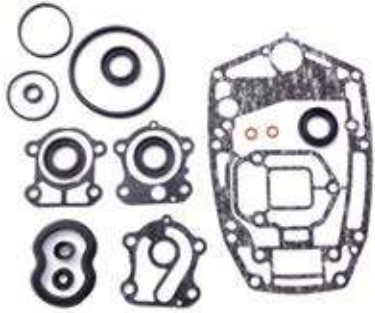

REF	OEM	
REC69D-W0001-20	69D-W0001-20	E60H



REF	OEM	
REC6F5-W0001-C0	6F5-W0001-C0	40G/E40G



REF	OEM	
REC6H2-W0001-20	6H2-W0001-20	60FETO/TR 70BETO/TR

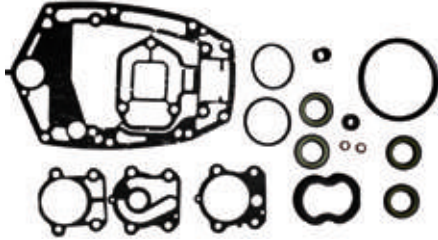

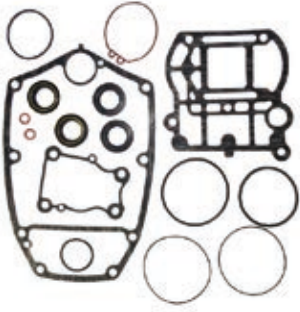

REF	OEM	
REC66T-W0001-20	66T-W0001-20	40X/E40X-MH/XW E40MCH

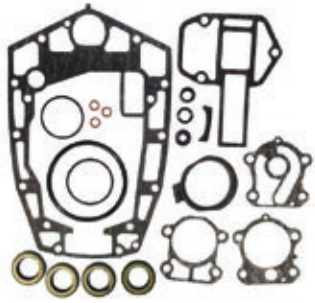

REF	OEM	
REC688-W0001-22	688-W0001-22	75CETO/E75B/AED 85A/AED/AET 90AETO/TR



REF	OEM	
REC64J-W0001-20	64J-W0001-20	F45/50 FT50 T50



REF	OEM	
REC688-W0001-20	688-W0001-20	75A/AE 80A 85A/AE 90A/AEO/AETO/ETN

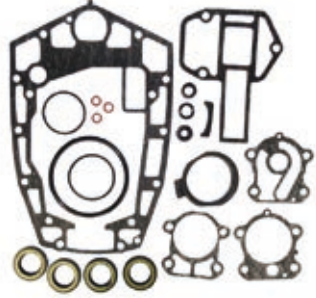

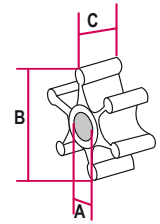

	REF	OEM	A	B	C
2A/B/C	REC646-44352-01	646-44352-01	11,5	47,5	13,7
F2.5, 3A, MALTA	REC6L5-44352-00	6L5-44352-00	10	36	14,5
4A/B, F4A, F4B, F5A, F6C, 5C	REC6E0-44352-00	6E0-44352-00	11	40	12,6
F6A/B, F8C, F9.9F, F9.9J	REC68T-44352-00	68T-44352-00	11,6	53	14
E8D	REC662-44352-01	662-44352-01	14	40	22
6C/D, 8C	REC6G1-44352-00	6G1-44352-00	11,9	40	18
F8, F9.9A/B/D, FT9.9A, 15D/9.9D	REC682-44352-01	682-44352-03	13	40	22
FT8D, 9.9F, F9.9C, FT9.9D, 15F, F15A-C, F20B, FT9.9G/L	REC63V-44352-01	63V-44352-01	12,85	53	14
20C, 25D, 30A	REC689-44352-02	689-44352-02	16,5	69,5	12,72
20D, 25N	REC6L2-44352-00	6L2-44352-00	13,97	51,2	19,05
F20A, F25A/D/G, FT25B, 25B/J/V, F30A, 30D/H/G, F40B/F, 40H/X, 50D	REC6H4-44352-02	6H4-44352-02	16,1	51,2	19,05
F40A/C, 40V/F/Y, F45A, 50G/H, 55B, PRO50, F50A/B/F, FT50B/C/G, F50H, FT50J, F60A/C/F, FT60B/D/G, 60F, 70B, F70A	REC6H3-44352-00	6H3-44352-00	18,05	51,8	19
40Q	REC6F5-44352-00	6F5-44352-00	16,04	69,8	22,1
60F'04-, 70B'04-, 75A/C, PRO75, 80A, 85A, 90A	REC688-44352-03	688-44352-03	20,1	58	30
F80A/B, F100A/D	REC67F-44352-00	67F-44352-00	20	58,2	34,7
F(L)115A/F(L), 150A, V4/V6, F100F, F175, 200F/G	REC6E5-44352-01	6E5-44352-01	22,4	89	31
F(L)225F, F(L) 250D, F(L)300B	REC6CE-44352-00	6CE-44352-00	22,5	90	36
F300, F350	REC6AW-44352-00	6AW-44352-00	24,6	89	36



REC646-44352-01



REC6L5-44352-00



REC6E0-44352-00



REC68T-44352-00



REC662-44352-01



REC6G1-44352-00



REC682-44352-01



REC63V-44352-01



REC689-44352-02



REC6L2-44352-00



REC6H4-44352-02



REC6H3-44352-00



REC6F5-44352-00



REC688-44352-03



REC67F-44352-00



REC6E5-44352-01



REC6CE-44352-00



REC6AW-44352-00

BOMBA DE AGUA

WATER PUMP

CUERPO BOMBA DE AGUA

HOUSING, WATER PUMP

REF	OEM	
PAF2.6-03000014	69M-G4311-00	F2.5



REF	OEM	
PAF25-04050001	61N-44311-01	25V 30G F20 F25



REF	OEM	
PAF4-03000019	68D-G4311-01	F4



REF	OEM	
PAF60-04000401	63D-44311-00	40V/MM/VE/TLR C40M-T 50H/HR-M/HM F40/45/50/60



REF	OEM	
REC63V-44301-00	63V-44301-00-00	F6/8/15/9.9/13.5 T8/9.9 9.9F/FEM/MH/MSH/FMH 13.5AWH 15F/FMH/MSH/MH F9.9 / 13.5 / 15/20 F
PAF20-04040000	6AH-44311-00	Última versión last version



REF	OEM	
REC676-44311-00	676-44311-00	E40GM/JM 40GW/JW/G/QE/QWC



REF	OEM	
REC689-44311-00	689-44311-03	20C/CM 25D/DE 30A



REF	OEM	
PAT40-04000201	66T-44311-00	40X/E40X-MLH T25/FT25 F30/F40





REF	OEM	
REC663-44311-02	663-44311-02-00	25B/BETO 40N/H/E 50G/GEO/GETO, 50D 55B/BET E55CMH 60FEO/FETO/FEDO, 60BE/BEM/BET 70CE







REF	OEM	
REC688-44311-01	688-44311-01	60FETO/TR E60H-E-M 70BETO/TR 75CETO/TLR E75B 75A/AE-T-M-D 80A/AE-O-T 85A/AE-D-T 90A/AETO/AEO/TLR
REC67F-44311-01	67F-44311-01-00	F80/100





REF	OEM		
REC6EE-G4311-00	6EE-G4311-00		



REF	OEM		
REC6CE-44311-01	6CE-44311-00 6CE-44311-01		F250 (2011+) V6 F300 (2011+) V6
REC6AW-44311-01	6AW-44311-00 6AW-44311-01		F300 (2008-11) V8 F350 (2008+) V8



REF	OEM		
REC61A-44311-00	6E5-44311-00		F80/100/115/150/200/225/250 150F/FET/TR/AET Z150P/TXR 175D 200F/FETO/G/GETO 200AET 225B/DET/G 250GETO/AET Z250DET/FET



REF	OEM		
REC6H3-44311-00	6H3-44311-00		FT/T 50/60 HP (1997+) 60F (1984-99)



TAPA DE LA BOMBA WATER PUMP, COVER



REF	OEM		
REC646-44323-00	646-44323-00		2B 2MSH 2BMH



REF	OEM		
REC61N-44323-00	61N-44323-00		25B/BMH/30H E30HM 30G E25A 25VE-M F20/F25



REF	OEM		
PAF2.6-03000010	69M-G4323-00		F2.5



REF	OEM		
REC6H3-44323-00	6H3-44323-00-00		25B/BETO F45 50G/GE T50 F50 FT50 60FE/TLR FT60 T60 70B/ETN/BE

REF	OEM		
REC6L5-44323-00	6L5-44323-00		3A/AMH 3MSH

REF	OEM		
REC63D-44323-00	63D-44323-00-00		F30/40/45/50/60 40V/VE-M/Y/YE C40MLH/T T50 50H/HM-R

REF	OEM		
REC68T-44323-00	68T-44323-00		F6 T8 F9.9 F20/6/9.9/8/13.5 T8/9.9

REF	OEM		
REC63V-44323-00	63V-44323-00-00		9.9F/FMH/FEMH/MSH F9.9/13.5/15 13.5AWH 15F/FM/MS

REF	OEM		
REC676-44323-00-40	676-44323-00		E40GMH/GW/JMH 40JWH/GWH 40QE/G/QM/QE-2/QWC

REF	OEM	
REC66T-44323-00	66T-44323-00	40X/E40X/MLH 40XW/XMH F30/40/T25





REF	OEM	
REC68V-44323-00	6EK-44323-00	F115





REF	OEM	
REC663-44323-00	663-44323-00	50G/GEO/GETO 30DET/DEO/DMH/ELH 60FEO, FETO, FEDO 70BEO/BETO/BEMO/CE 40N/H, 40E/H 50ETN/D/DE 25J/JEO/JETO/ESH 25Q/QEO/E55CMH 55B/BM/BET





REF	OEM	
REC6G5-44323-00	6G5-44323-01	F150/200/225 Z150/175/250/300 VZ200 250AET/B/GET 225C/CET/D/DET 150F/FET/AET 175D/DET/AET 200F/FET/GE 225G 200AET/BET 150CET 175BET





REF	OEM	
REC688-44323-00	688-44323-00-00	60FET/TR 75CETO/AED-T 70BET/TR 75A/AE-M/TLR/CETO/AED-T E75B 80A/AET/TLR 85A/AE-D-T 90A/AET/ETN/TR





REF	OEM	
REC6P2-44323-00	6P2-44323-0	Z250 F225/F250



REF	OEM	
REC67F-44323-00	67F-44323-00	F75/F80/ F100



REF	OEM	
REC6EE-G4323-00	6EE-G4323-00	



REF	OEM	
REC6E5-44323-00-40	6E5-44323-00	100A/AETO/TLR 115CET/A/B/BET C115TLR 130BET 140AET/BET



REF	OEM	
REC646-44323-00	646-44323-00	





TORNILLO HEXAGONAL **EXA SCREW**

REF	OEM	
REC97D95-06045	97D95-06045	







TORNILLO CON ARANDELA

SCREW WITH WASHER

REF	OEM	
REC90119-08191	90119-08191	



REF	OEM	
REC90119-08194	90119-08194	

REF	OEM	
REC97E95-08545	97E95-08545	

REF	OEM	
REC97E95-08555	97E95-08555	

CASQUILLO INOX

SS INSERT

REF	OEM	
REC6EE-G4322-00	6EE-G4322-00	

REF	OEM	
REC308928	0308928, 308928	

JUNTA BOMBA DE AGUA

WATER PUMP GASKET

REF	OEM	
REC6E0-45315-A0	6E0-45315-A0	

REF	OEM	
REC6H3-44324-A0-00	6H3-44324-A0-00	25 --> 70 HP



KITS DE REPARACIÓN BOMBA DE AGUA

WATER PUMP SERVICE KITS

REF	OEM	
REC6A1-W0078-01	6A1-W0078-01	2B (1985-88)





REF	OEM	
REC6EE-W0078-01	6BX-WG0078-00 6EE-W0078-00 6EE-W0078-01	F4B/M (2010+) F5A/M (2010+) F6C/M (2010+)



REF	OEM	
REC68T-W0078-00	68T-W0078-01 68T-W0078-00	F6A/B/M (2005-09) F8C/F/M (2005+) F9.9 F/M/J (2008+)



REF	OEM	
REC63V-W0078-01	63V-W0078-00	9.9F 13.5AWH 15F F9.9 F15 F13.5





REF	OEM	
REC6G1-W0078-A1	6G1-W0078-A1 6G1-W0078-00 6N0-W0078-A0 6G1-W0078-01	6C/D/M/T (1984-14) 8C/N/J/F/T/M





REF	OEM	
REC682-W0078-A1	682-W0078-A1	9.9/15D F8 F9.9



REF	OEM	
REC68T-W0078-00	69G-W0078-01 69G-W0078-00	F1/T8 D/P/E/M/G (2005+) F1/T9.9 E/G/M/L (2008+)





REF	OEM	
REC61N-W0078-11	61N-W0078-11 61N-W0078-10	F20A/D (1998-17) F25A/E/T/M/D (1998-18)





REF	OEM	
REC6AH-W0078-00	6AH-W0078-00 6AH-W0078-01	F9.9 (2009+) F13.5B (2007-09) F15C/E/M (2007+) F20B/M (2007+)





REF	OEM	
REC689-W0078-A6	689-W0078-04	20CM





REF	OEM	
REC689-W0078-A6	689-W0078-A6	20C 25D



REF	OEM	
REC6L2-W0078-00	6L2-W0078-00	20D/DEO/DEM/MSH/DM/MLH 20MSH/DMH/DWO





REF	OEM	
REC63D-W0078-01	63D-W0078-01	40V/C40 (1998+) 50H (1997-03) F45A (1997-00) F50A/H/F/T (1997+) F40A/E/Y/D/H (1999+) F60A/B/C/T (2002+) F40/45/50/60 40V/VMH/VETO/VMH C40MLH/T/TLR 40VE/VEO/VES 40Y/YETO 50H/HET/HMH





REF	OEM	
REC6J8-W0078-A2	6J8-W0078-A1	25J/JEO 30D/DE/DMH





REF	OEM	
REC6H4-W0078-00	6H4-W0078-00	25Q/QEO, 40N/H/HE E48CMH, 50D/DE/AETN E55CMH





REF	OEM	
REC6CJ-W0078-00	6CJ-W0078-00	F40G (2011+) F70A (2011+)





REF	OEM	
REC6BG-W0078-00	6BG-W0078-00	F30B (2009+) F40A/F (2009+)



REF	OEM	
REC679-W0078-A1	679-W0078-00	40QE





REF	OEM	
REC679-W0078-A1	6F5-W0078-00	E40GMH 40GWH





REF	OEM
REC6E0-W0078-A2	6E0-W0078-A2
REC6E0-W0078-00	6E0-W0078-00
REC6E0-W0078-01	6E0-W0078-01
REC6E0-W0078-02	6E0-W0078-02



REF	OEM	
REC66T-W0078-00	66T-W0078-01	40X E40X



REF	OEM	
REC67F-W0078-00	67F-W0078-00	F80/100





REF	OEM	
REC663-W0078-01	663-W0078-01	55B (1992-18) 55BET



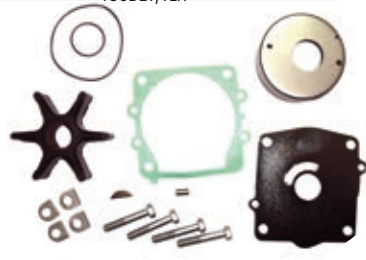

REF	OEM	
REC6N6-W0078-02	6N6-W0078-00	115B/BE/BET/CETO/TRX/CETO 130BET/TLR



REF	OEM	
REC6H3-W0078-02	6H3-W0078-00	60FE/FET/FEO/FETO 70AETN/B/BEH/BE0/CE





REF	OEM	
REC68V-W0078-00	68V-W0078-00	F115 FL115 LF115





REF	OEM	
REC692-W0078-02	692-W0078-02	60TR/FETO 75AED/AET 75CETO/TLR/E75B 70BETO/TR 80A 85A/AE/AED/AET/AEM 90A/AETO/AEMO/TLR C90TRZ



REF	OEM	
REC65N-W0078-A1	65N-W0078-A1	D150H/N/NETOL







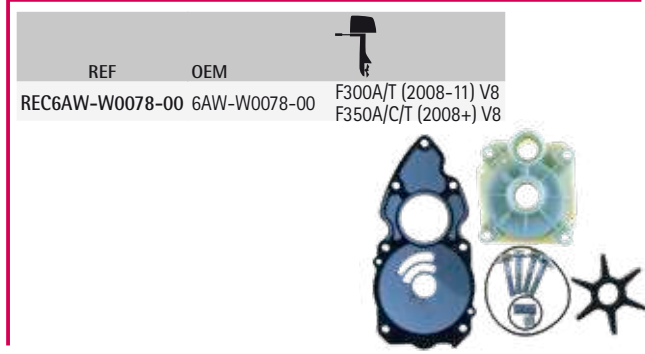
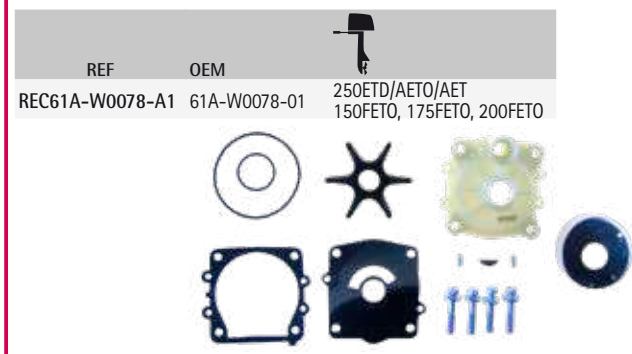
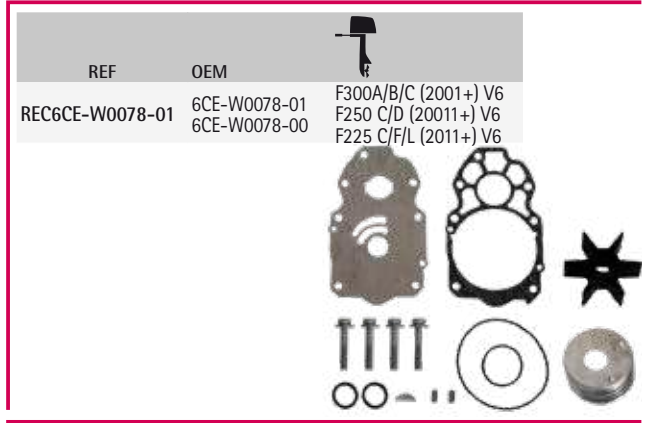
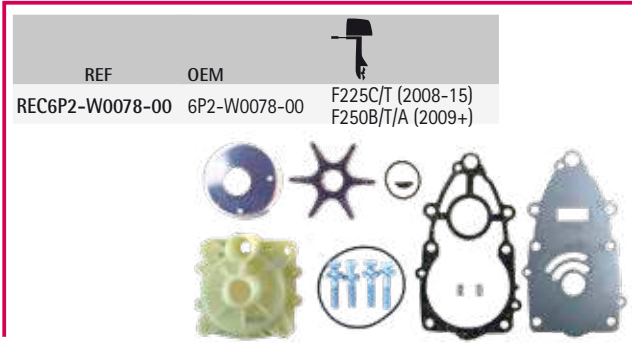



REF	OEM	
REC6G5-W0078-A1	6G5-W0078-00 6G5-W0078-01 6G5-W0078-A1	150A/C/E (1984-91) 175A/B (1984-91) 200A/E/B (1984-91) 225A/B (1987-91)





4T STROKES **GUÍA BOMBAS DE AGUA**

GUIDE WATER PUMP

		1	2	3	4	5	6	7	KIT		
	F2.5	69F0 > 69F3 60N1 > 60N5	2003	REC6L5-44352-00	PAF2.6-03000015	PAF2.6-03000010	PAF2.6-03000014	PAJASOF404-19-033	PAF4-03000021	PAF2.6-03000013	
	F4	68R > 68R3 60P1 > 60P2	2002-09	REC6E0-44352-00	REC6E0-44322-02	PAF4-03000015	PAF4-03000019	PAF4-03000018	PAF4-03000021	PAF4-03000016	
	F5		2010	REC6E0-44352-00	PAF6-03000002		PAF6-03000001		PAF4-03000021	PAF4-03000016	
	F6B, BMH, A, AM, AW, ML, MH	6J6 > 6J7	2001-09	REC68T-44352-00	REC63V-44322-00	REC68T-44323-00	REC63V-44301-00	REC93210-44398	REC68T-44366-00	REC664-44338-00	REC68T-W0078-00
	F6A, ML, MS, AM, BM	60R1 > 60R9 68T > 68T3 60RA > 60RB 6FW1	2000-06	REC68T-44352-00	REC63V-44322-00	REC68T-44323-00	REC63V-44301-00	REC93210-44398	REC68T-44366-00	REC664-44338-00	REC68T-W0078-00
	F6 (1cyl)		2010	REC6E0-44352-00	PAF6-03000002		PAF6-03000001	PAF4-03000018	PAF4-03000021	PAF4-03000016	
	F8AM, B, BE, BM	6G8	1986-95	REC682-44352-01	REC682-44322-00	REC682-44323-40		REC682-44315-00	REC682-44365-00	REC90280-03024	REC682-W0078-A1
	F8C, ML, CM, MS, MH, ML, FM	6G9	2000-15	REC68T-44352-00	REC63V-44322-00	REC68T-44323-00	REC63V-44301-00	REC93210-44398	REC68T-44366-00	REC664-44338-00	REC68T-W0078-00
	T8		2001-10	REC63V-44352-01	REC63V-44322-00	REC68T-44323-00	REC63V-44301-00	REC93210-44398	REC68T-44366-00	REC664-44338-00	
	F9.9A, AE, AM	66N1 > 66N8	1985-96	REC682-44352-01	REC682-44322-00	REC682-44323-40		REC682-44315-00	REC682-44365-00	REC90280-03024	REC682-W0078-A1
	F9.9B, BE, BM	6AU1 > 6AU6 6DR1 > 6DR3	1985-96	REC682-44352-01	REC682-44322-00	REC682-44323-40		REC682-44315-00	REC682-44365-00	REC90280-03024	REC682-W0078-A1
	F9.9	66R > 66R8	1985-04	REC682-44352-01	REC682-44322-00	REC682-44323-40		REC682-44315-00	REC682-44365-00	REC90280-03024	REC682-W0078-A1
	F9.9C, CE, CM, CW, MH	69C > 69C1	1998-08	REC63V-44352-01	REC63V-44322-00	REC63V-44323-00	REC63V-44301-00	REC93210-44398	REC647-44366-00	REC664-44338-00	REC63V-W0078-01
	F9.9F, FE, FM, MH, ML, JE, JM		2008-15	REC63V-44352-01	REC63V-44322-00	REC68T-44323-00	REC63V-44301-00	REC93210-44398	REC68T-44366-00	REC664-44338-00	REC68T-W0078-00
	F19.9D, DE, DM, DW		1999-08	REC63V-44352-01	REC63V-44322-00	REC63V-44323-00	REC63V-44301-00	REC93210-44398	REC647-44366-00	REC664-44338-00	REC63V-W0078-01
	F19.9D, DEP, PLR, TR	6CA1 > 6CA8	2000-02	REC63V-44352-01	REC63V-44322-00	REC63V-44323-00	REC63V-44301-00	REC93210-44398	REC647-44366-00	REC664-44338-00	REC63V-W0078-01
	FT9.9		1985-99	REC682-44352-01	REC682-44322-00	REC682-44323-40		REC682-44315-00	REC682-44365-00	REC90280-03024	REC682-W0078-A1
	T9.9	69V2 > 69V8	1991-99	REC682-44352-01	REC682-44322-00	REC682-44323-40		REC682-44315-00	REC682-44365-00	REC90280-03024	REC682-W0078-A1
	F9.9HE, HMH	6P71 > 6P74	2009-15	REC63V-44352-01	REC63V-44322-00			REC6L2-44367-00	REC664-44338-00	REC6AH-W0078-00	
	T9.9	6AF1 > 6AF3	2005-06	REC63V-44352-01	REC63V-44322-00	REC63V-44323-00	REC63V-44301-00	REC93210-44398	REC647-44366-00	REC664-44338-00	REC63V-W0078-01
	F13.5AE, AM	66M > 66M7	2002-07	REC63V-44352-01	REC63V-44322-00	REC63V-44323-00	REC63V-44301-00	REC93210-44398	REC647-44366-00	REC664-44338-00	REC63V-W0078-01
	F13.5AEP		2005-07	REC63V-44352-01	REC63V-44322-00	REC63V-44323-00	REC63V-44301-00	REC93210-44398	REC647-44366-00	REC664-44338-00	REC63V-W0078-01
	F13.5B, BMH	6AG1 > 6AG9 6AGA	2007-09	REC63V-44352-01	REC63V-44322-00				REC6L2-44367-00	REC664-44338-00	REC6AH-W0078-00
	F15A, AE, AM, EL, MH	65P1 > 65P5	1998-07	REC63V-44352-01	REC63V-44322-00	REC63V-44323-00	REC63V-44301-00	REC93210-44398	REC647-44366-00	REC664-44338-00	REC63V-W0078-01
	F15	6DN1 > 6DN6	2006-11	REC63V-44352-01	REC63V-44322-00	REC68T-44323-00		REC93210-49046	REC6L2-44367-00	REC664-44338-00	
	F15CE, CM, CW, EL, MH	6AH1 > 6AH9 6AHA	2007-15	REC63V-44352-01	REC63V-44322-00				REC6L2-44367-00	REC664-44338-00	REC6AH-W0078-00
	F20AE	65W > 65W9	2003-06	REC6H4-44352-02	REC61N-44322-00	REC61N-44323-00	PAF25-04050001	PAF25-04050003	REC6L2-44367-00	REC90280-03024	REC61N-W0078-11

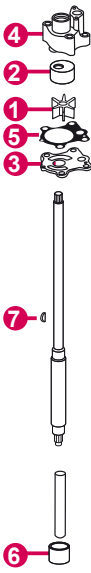

			1	2	3	4	5	6	7	KIT
F20DET	6BP1>6BP8	2011-15	REC6H4-44352-02	REC61N-44322-00	REC61N-44323-00	PAF25-04050001	PAF25-04050003	REC6L2-44367-00	REC90280-03024	REC61N-W0078-11
F20B, BE, BM, BV, EL, MH		2007-15	REC63V-44352-01	REC63V-44322-00				REC6L2-44367-00	REC664-44338-00	REC6AH-W0078-00
F25A, AE, AM, AV, EL, MH		1998-09	REC6H4-44352-02	REC61N-44322-00	REC61N-44323-00	PAF25-04050001	PAF25-04050003	REC6L2-44367-00	REC90280-03024	REC61N-W0078-11
F25DE, DM, MH	6BT1>6BT8	2009-215	REC6H4-44352-02	REC61N-44322-00	REC61N-44323-00	PAF25-04050001	PAF25-04050003	REC6L2-44367-00	REC90280-03024	REC61N-W0078-11
T25	66W>66W1	2001-06, 2009	REC6H4-44352-02	REC63D-44322-00	REC66T-44323-00		REC93210-59MG7		REC90280-03M03	REC66T-W0078-00
F30	60K1	2001-05	REC6H4-44352-02	REC63D-44322-00	REC66T-44323-00		REC93210-59MG7		REC90280-03M03	REC66T-W0078-00
F30BE		2009-15	REC6H4-44352-02	REC63D-44322-00	REC63D-44323-00		REC93210-59MG7	REC663-44366-00	REC90280-03M03	REC6BG-W0078-00
F40 A, ELH	6BG1>6BG8	1999-02	REC6H3-44352-00	REC63D-44322-00	REC63D-44323-00		REC93210-59MG7		REC90280-03024	REC63D-W0078-01
F40 CET	6AK1>6AK9 6AKA>6AKB	2002	REC6H3-44352-00	REC63D-44322-00	REC63D-44323-00		REC93210-59MG7		REC90280-03024	REC63D-W0078-01
F40	6CY1>6CY6	2000-08	REC6H4-44352-02	REC63D-44322-00	REC66T-44323-00		REC93210-59MG7		REC90280-03M03	REC66T-W0078-00
F40FE	62Y	2009-15	REC6H4-44352-02	REC63D-44322-00	REC63D-44323-00		REC93210-59MG7	REC663-44366-00	REC90280-03M03	REC6BG-W0078-00
F40D, DE, HE	62Y	2006-15	REC6H3-44352-00	REC63D-44322-00	REC63D-44323-00		REC93210-59MG7	REC663-44366-00	REC90280-03024	REC63D-W0078-01
F40GET	62Y>62Y6	2011-15	REC6H3-44352-00 REC63D-44322-00					REC663-44366-00	REC90280-03M03	REC6CJ-W0078-00
F45 AET	60A3 60AA	1999	REC6H4-44352-02	REC61N-44322-00	REC61N-44323-00	PAF25-04050001	PAF25-04050003	REC6L2-44367-00	REC90280-03024	REC61N-W0078-11
F50TJR	6C11>6C19	2003	REC6H4-44352-02	REC61N-44322-00	REC61N-44323-00	PAF25-04050001	PAF25-04050003	REC6L2-44367-00	REC90280-03024	REC61N-W0078-11
F50 A, AE, TJ, TL	6C1A>6C1C	1997-07	REC6H3-44352-00	REC63D-44322-00	REC63D-44323-00		REC93210-59MG7	REC663-44366-00	REC90280-03024	REC63D-W0078-01
F50 DETL	64J	1995-10	REC6H3-44352-00	REC63D-44322-00	REC63D-44323-00		REC93210-59MG7	REC663-44366-00	REC90280-03024	REC63D-W0078-01
F50F, FE, TR, TL		2005-12	REC6H3-44352-00	REC63D-44322-00	REC63D-44323-00		REC93210-59MG7	REC663-44366-00	REC90280-03024	REC63D-W0078-01
F50 HED	69W1>69W6	2013-15	REC6H3-44352-00	REC63D-44322-00	REC63D-44323-00		REC93210-59MG7	REC663-44366-00	REC90280-03024	REC63D-W0078-01
FT50B, T50TLR	6C51>6C59	1997-99	REC6H3-44352-00	REC63D-44322-00	REC63D-44323-00		REC93210-59MG7	REC663-44366-00	REC90280-03024	REC63D-W0078-01
T50	6C5A>6C5C	1996	REC6H3-44352-00	REC663-44322-00	REC6H3-44323-00		REC6H3-44315-00		REC90280-03024	REC6H3-W0078-02
F60 AE, TL, TJ		2002-07	REC6H3-44352-00	REC63D-44322-00	REC63D-44323-00		REC6H3-44315-00	REC663-44366-00	REC90280-03M03	REC63D-W0078-01
F60 A, C, CET, TR, TJR	6CJ1>6CJ6	2005-12	REC6H3-44352-00	REC63D-44322-00	REC63D-44323-00		REC6H3-44315-00	REC663-44366-00	REC90280-03M03	REC63D-W0078-01
F60 B, FET	6D61	2013-15	REC6H3-44352-00	REC63D-44322-00	REC63D-44323-00		REC6H3-44315-00	REC663-44366-00	REC90280-03M03	REC63D-W0078-01
T60	67G0>67G5	2003-11	REC6H3-44352-00	REC663-44322-00	REC6H3-44323-00		REC6H3-44315-00		REC90280-03M03	REC6H3-W0078-02
F70A, AET	6D71>6D79 6D7A>6D7C	2011-15	REC6H3-44352-00 REC63D-44322-00					REC663-44366-00	REC90280-03M03	REC6CJ-W0078-00
F75BET, TR, TLR		2005	REC67F-44352-00	REC67F-44322-00	REC67F-44323-00	REC67F-44311-01	REC688-44315-00		REC90280-04M04	REC67F-W0078-00
F80A, AET, TLR, TJR	67F>67F5	1999-03	REC67F-44352-00	REC67F-44322-00	REC67F-44323-00	REC67F-44311-01	REC688-44315-00		REC90280-04M04	REC67F-W0078-00
F80B, BET	6D91>6D99 6D9A>6D9C	2005-15	REC67F-44352-00	REC67F-44322-00	REC67F-44323-00	REC67F-44311-01	REC688-44315-00		REC90280-04M04	REC67F-W0078-00
F90	68V, 68V0, 68W0	2003-11	REC67F-44352-00	REC67F-44322-00	REC67F-44323-00	REC67F-44311-01	REC688-44315-00		REC90280-04M04	REC67F-W0078-00
F100A, AET, TLR, TRZ		1999-06	REC67F-44352-00	REC67F-44322-00	REC67F-44323-00	REC67F-44311-01	REC688-44315-00		REC90280-04M04	REC67F-W0078-00
F100DET	68V, 68V0, 68W0	2005-15	REC67F-44352-00	REC67F-44322-00	REC67F-44323-00	REC67F-44311-01	REC688-44315-00		REC90280-04M04	REC67F-W0078-00
F115A (68V/68W0)		2000-01	REC6E5-44352-01	REC61A-44322-02	REC6E5-44323-00-40	REC61A-44311-00	REC93210-86M38		REC90280-04M05	REC6N6-W0078-02
F115TLR (68V)	68V1>68V9 68VA>68VF	2000	REC6E5-44352-01	REC61A-44322-02	REC6E5-44323-00-40	REC61A-44311-00	REC93210-86M38		REC90280-04M05	REC6N6-W0078-02
F115TLR/ TRZ/ TXR	68W1>68W9 68WA>68WF	2000-01	REC6E5-44352-01	REC61A-44322-02	REC6E5-44323-00-40	REC61A-44311-00	REC93210-86M38		REC90280-04M05	REC6N6-W0078-02
LF115TXR (68W/68W0)	6EK1>6EK2 6EL1>6EL2	2000-01	REC6E5-44352-01	REC61A-44322-02	REC6E5-44323-00-40	REC61A-44311-00	REC93210-86M38		REC90280-04M05	REC6N6-W0078-02
F115A, AET, TJR	6EM1	2002-15	REC6E5-44352-01	REC61A-44322-02	REC68V-44323-00	REC61A-44311-00	REC93210-86M38		REC90280-04M05	REC68V-W0078-00
LF/FL115A, AET, TX, TR, B, BET		2002-15	REC6E5-44352-01	REC61A-44322-02	REC68V-44323-00	REC61A-44311-00	REC93210-86M38		REC90280-04M05	REC68V-W0078-00
F/FL/FL115B, BET		2014-15	REC6E5-44352-01	REC61A-44322-02	REC68V-44323-00	REC61A-44311-00	REC93210-86M38		REC90280-04M05	REC68V-W0078-00
F130A, AET		2015	REC6E5-44352-01	REC61A-44322-02	REC68V-44323-00	REC61A-44311-00	REC93210-86M38		REC90280-04M05	REC68V-W0078-00
F150/FL150		2004-12	REC6E5-44352-01	REC61A-44322-02	REC6G5-44323-00	REC61A-44311-00	REC93210-86M38		REC90280-04M05	REC61A-W0078-A1
F200/FL200		2002-11	REC6E5-44352-01	REC61A-44322-02	REC6G5-44323-00	REC61A-44311-00	REC93210-86M38		REC90280-04M05	REC61A-W0078-A1
VF200	6BB2>6BB9	2009-11	REC6E5-44352-01	REC61A-44322-02		REC61A-44311-00	REC93210-86M38			
F225/FL225	6CL1>6CL4 6CM1>6CM4	2002-10	REC6E5-44352-01	REC61A-44322-02	REC6G5-44323-00	REC61A-44311-00	REC93210-86M38		REC90280-04M05	REC61A-W0078-A1
F225/FL225		2007-09 (20*)	REC6E5-44352-01	REC61A-44322-02	REC6P2-44323-00	REC61A-44311-00	REC93210-86M38		REC90280-04M05	REC6P2-W0078-00
F225CET		2009-15	REC6E5-44352-01	REC61A-44322-02	REC6P2-44323-00	REC61A-44311-00	REC93210-86M38		REC90280-04M05	REC6P2-W0078-00
LF/FL/F225CA, FET	6BR1>6BR3 6BS1>6BS3	2011-13	REC6CE-44352-00							
VF225	6P2A 6P23>6P29	2009-11	REC6E5-44352-01	REC61A-44322-02		REC61A-44311-00	REC93210-86M38			
F250/FL250	6P33>6P39	2005	REC6E5-44352-01	REC61A-44322-02	REC6G5-44323-00	REC61A-44311-00	REC93210-86M38		REC90280-04M05	REC61A-W0078-A1
FJ/F250BET	6CG1>6CG4 6CH1>6CH4	2001-11	REC6E5-44352-01	REC61A-44322-02	REC6P2-44323-00	REC61A-44311-00	REC93210-86M38		REC90280-04M05	REC6P2-W0078-00
F250A, AET, TR, TUR		2007-13	REC6E5-44352-01	REC61A-44322-02	REC6P2-44323-00	REC61A-44311-00	REC93210-86M38		REC90280-04M05	REC6P2-W0078-00
LF/FL250A, AET, TR, TX	6CE1>6CE4 6CF1>6CF4	2007-12	REC6E5-44352-01	REC61A-44322-02	REC6P2-44323-00	REC61A-44311-00	REC93210-86M38		REC90280-04M05	REC6P2-W0078-00
LF/FL/F250CA, DET	6BJ1>6BJ4 6BK1>6BK4	2011-13	REC6CE-44352-00							
VF250	6AW1>6AW9	2009-10	REC6E5-44352-01	REC61A-44322-02		REC61A-44311-00	REC93210-86M38		REC90280-04M05	
F300 FL300BET, CA	6AX1>6AX9	2011-13	REC6CE-44352-00							
F300/ FL300AET		2008-11								REC6AW-W0078-00
F350AET, CB, TRG, TUR		2008-15								REC6AW-W0078-00

			1	2	3	4	5	6	7	KIT
2B	6A1	1985-99								REC6A1-W0078-01
2B, MSHA	6A11>6A12 6F89	2002-10	REC646-44352-01			REC646-44323-00				REC646-44323-00
4AC, AS	6E0>6E1	1985-96	REC6E0-44352-00	REC6E0-44322-02	PAF4-03000015			PAF4-03000021		REC6E0-W0078-A2
5C, CS	6E3>6E4	1985-96	REC6E0-44352-00	REC6E0-44322-02	PAF4-03000015			PAF4-03000021		REC6E0-W0078-A2
6 D /DEM	6H8	1984-96	REC6G1-44352-00	REC6G1-44322-00	REC6G1-44323-00		REC6G1-44315-A0	REC647-44366-00	REC90280-03024	REC6G1-W0078-A1
6 J / C / CEM	6H6	1984-96	REC6G1-44352-00	REC6G1-44322-00	REC6G1-44323-00		REC6G1-44315-A0	REC647-44366-00	REC90280-03024	REC6G1-W0078-A1
8 N / J / C / CEM	6G1	1984-96	REC6G1-44352-00	REC6G1-44322-00	REC6G1-44323-00		REC6G1-44315-A0	REC647-44366-00	REC90280-03024	REC6G1-W0078-A1
9.9D	6,00E+007	1984-95	REC682-44352-01	REC682-44322-00	REC682-44323-40		REC682-44315-00	REC682-44365-00	REC90280-03024	REC682-W0078-A1
9.9F, FEM, FM, MH, MS	63V	1995-00	REC63V-44352-01	REC63V-44322-00	REC63V-44323-00	REC63V-44301-00	REC93210-44398	REC647-44366-00	REC664-44338-00	REC63V-W0078-01
13.5AWH	63V	1998	REC63V-44352-01	REC63V-44322-00	REC63V-44323-00	REC63V-44301-00	REC93210-44398	REC647-44366-00	REC664-44338-00	REC63V-W0078-01
15D	6,00E+008	1984-95	REC682-44352-01	REC682-44322-00	REC682-44323-40		REC682-44315-00	REC682-44365-00	REC90280-03024	REC682-W0078-A1
15F, FEM, MH, MS	63W	1995-00	REC63V-44352-01	REC63V-44322-00	REC63V-44323-00	REC63V-44301-00	REC93210-44398	REC647-44366-00	REC664-44338-00	REC63V-W0078-01
20D, DE, DM, MLH, MSH, DW	6L3>6L39	1998-11	REC6L2-44352-00	REC6L2-44322-00			REC93210-45161	REC6L2-44367-00		REC6L2-W0078-00
20C	6A9 / 6A90 / 6A91	1997-02	REC689-44352-02	REC689-W4432-01	REC689-44323-00	REC689-44311-00	REC689-44324-A0	REC689-44366-00	REC664-44338-00	REC689-W0078-A6
20CM	6A9	1992	REC689-44352-02	REC689-W4432-01	REC689-44323-00	REC689-44311-00	REC689-44324-A0	REC689-44366-00	REC664-44338-00	REC689-W0078-A6
25D	6950	2001	REC689-44352-02	REC689-W4432-01	REC689-44323-00	REC689-44311-00	REC689-44324-A0	REC689-44366-00	REC664-44338-00	REC689-W0078-A6
25		1984-85	REC689-44352-02	REC689-W4432-01	REC689-44323-00	REC689-44311-00	REC689-44324-A0	REC689-44366-00	REC664-44338-00	REC689-W0078-A6
25D, N, NE, MLH, MSH, NMH	6L2>6L29	1998-10	REC6L2-44352-00	REC6L2-44322-00			REC93210-45161	REC6L2-44367-00		REC6L2-W0078-00
25NMH, MW, NH	6L2A>6L2F	2011-15	REC6L2-44352-00	REC6L2-44322-00			REC93210-45161	REC6L2-44367-00		REC6L2-W0078-00
25 J, JEO	6K9	1987-94	REC6H4-44352-02	REC663-44322-00	REC663-44323-00	REC663-44311-02	REC663-44315-A0	REC663-44366-00	REC90280-03024	REC6J8-W0078-A2
C25		1990-97	REC689-44352-02	REC689-W4432-01	REC689-44323-00	REC689-44311-00	REC689-44324-A0	REC689-44366-00	REC664-44338-00	REC689-W0078-A6
CV25		1990	REC689-44352-02	REC689-W4432-01	REC689-44323-00	REC689-44311-00	REC689-44324-A0	REC689-44366-00	REC664-44338-00	REC689-W0078-A6
30		1984-85	REC689-44352-02	REC689-W4432-01	REC689-44323-00	REC689-44311-00	REC689-44324-A0	REC689-44366-00	REC664-44338-00	REC689-W0078-A6
30		1986	REC689-44352-02	REC689-W4432-01	REC689-44323-00	REC689-44311-00	REC689-44324-A0	REC689-44366-00	REC664-44338-00	REC689-W0078-A6
30D		1986-94	REC6H4-44352-02	REC663-44322-00	REC663-44323-00	REC663-44311-02	REC663-44315-A0	REC663-44366-00	REC90280-03024	REC682-W0078-A1
30D, DE, DMH	6J8	1986-94	REC6H4-44352-02	REC663-44322-00	REC663-44323-00	REC663-44311-02	REC663-44315-A0	REC663-44366-00	REC90280-03024	REC6J8-W0078-A2
C30		1990-92	REC689-44352-02	REC689-W4432-01	REC689-44323-00	REC689-44311-00	REC689-44324-A0	REC689-44366-00	REC664-44338-00	REC689-W0078-A6
C30		1993-97	REC6H4-44352-02	REC61N-44322-00	REC61N-44323-00	PAF25-04050001	PAF25-04050003	REC6L2-44367-00	REC90280-03024	REC61N-W0078-11
40		1984-87	REC6H4-44352-02	REC663-44322-00	REC663-44323-00	REC663-44311-02	REC663-44315-A0	REC663-44366-00	REC90280-03024	REC6H4-W0078-00
40		1988-94	REC6H4-44352-02	REC663-44322-00	REC663-44323-00		REC663-44315-A0	REC663-44366-00	REC90280-03024	REC6H4-W0078-00
40		1995-05	REC6H3-44352-00	REC63D-44322-00	REC63D-44323-00	PAF60-04000401	REC93210-59MG7	REC663-44366-00	REC90280-03024	REC63D-W0078-01
E40GMH	6F62	2003	REC6F5-44352-00	REC676-44322-00	REC676-44323-00-40	REC676-44311-00	REC676-44315-00	REC663-44366-00	REC90280-04M00	REC679-W0078-A1
40GWH	6F62	2003	REC6F5-44352-00	REC676-44322-00	REC676-44323-00-40	REC676-44311-00	REC676-44315-00	REC663-44366-00	REC90280-04M00	REC679-W0078-A1
C40		1990-91	REC6F5-44352-00	REC676-44322-00	REC676-44323-00-40	REC676-44311-00	REC676-44315-00	REC663-44366-00	REC90280-04M00	REC679-W0078-A1
C40		1992-97	REC6F5-44352-00	REC676-44322-00	REC676-44323-00-40	REC676-44311-00	REC676-44315-00	REC663-44366-00	REC90280-04M00	REC679-W0078-A1
40QE	6R6	1990	REC6F5-44352-00	REC676-44322-00	REC676-44323-00-40	REC676-44311-00	REC676-44315-00	REC663-44366-00	REC90280-04M00	REC679-W0078-A1
EK40JM	6H95	2006	REC6F5-44352-00	REC676-44322-00	REC676-44323-00-40	REC676-44311-00	REC676-44315-00	REC663-44366-00	REC90280-04M00	REC679-W0078-A1
C40MLH	63B>63B2	2000-03	REC6H3-44352-00	REC63D-44322-00	REC63D-44323-00	PAF60-04000401	REC93210-59MG7	REC663-44366-00	REC90280-03024	REC63D-W0078-01
C40T, TLRZ	63D>63D6	1996-03	REC6H3-44352-00	REC63D-44322-00	REC63D-44323-00	PAF60-04000401	REC93210-59MG7	REC663-44366-00	REC90280-03024	REC63D-W0078-01
P40		1998	REC6H3-44352-00	REC63D-44322-00	REC63D-44323-00	PAF60-04000401	REC93210-59MG7	REC663-44366-00	REC90280-03024	REC63D-W0078-01
40V, VE	63D>63D6	1996-03	REC6H3-44352-00	REC63D-44322-00	REC63D-44323-00	PAF60-04000401	REC93210-59MG7	REC663-44366-00	REC90280-03024	REC63D-W0078-01
40V, VE, VEO, VES	63C>63C9 63CA>63CF	1997-15	REC6H3-44352-00	REC63D-44322-00	REC63D-44323-00	PAF60-04000401	REC93210-59MG7	REC663-44366-00	REC90280-03024	REC63D-W0078-01
40V, VMH	63B>63BF	1995-15	REC6H3-44352-00	REC63D-44322-00	REC63D-44323-00	PAF60-04000401	REC93210-59MG7	REC663-44366-00	REC90280-03024	REC63D-W0078-01
50		1984-84	REC6H4-44352-02	REC663-44322-00	REC663-44323-00	REC663-44311-02	REC663-44315-A0	REC663-44366-00	REC90280-03024	REC6H4-W0078-00
50HMD0, H	62W,63G	1995-00	REC6H3-44352-00	REC63D-44322-00	REC63D-44323-00	PAF60-04000401	REC93210-59MG7	REC663-44366-00	REC90280-03024	REC63D-W0078-01
50H, HEM, HWH / CS0TLR	62X>62X5	2000-03	REC6H3-44352-00	REC63D-44322-00	REC63D-44323-00	PAF60-04000401	REC93210-59MG7	REC663-44366-00	REC90280-03024	REC63D-W0078-01
C50		1998-01	REC6H3-44352-00	REC63D-44322-00	REC63D-44323-00	PAF60-04000401	REC93210-59MG7	REC663-44366-00	REC90280-03024	REC63D-W0078-01
PRO 50		1987	REC6H4-44352-02	REC663-44322-00	REC663-44323-00	REC663-44311-02	REC663-44315-A0	REC663-44366-00	REC90280-03024	REC6H4-W0078-00
PRO 50		1988-90	REC6H4-44352-02	REC663-44322-00	REC663-44323-00	REC663-44311-02	REC663-44315-A0	REC663-44366-00	REC90280-03024	REC6H4-W0078-00
P50		1991-93	REC6H4-44352-02	REC663-44322-00	REC663-44323-00	REC663-44311-02	REC663-44315-A0	REC663-44366-00	REC90280-03024	REC6H4-W0078-00
P50		1995-96	REC6H3-44352-00	REC689-W4432-01	REC63D-44323-00	PAF60-04000401	REC93210-59MG7	REC663-44366-00	REC90280-03024	REC63D-W0078-01
55B, BET, BM	697	1992-00	REC6H3-44352-00	REC663-44322-00	REC663-44323-00	REC663-44311-02	REC663-44315-A0	REC663-44366-00	REC90280-03M03	REC663-W0078-01
55B, BET, BM	6970>6971	1989	REC6H3-44352-00	REC663-44322-00	REC663-44323-00	REC663-44311-02	REC663-44315-A0	REC663-44366-00	REC90280-03M03	REC663-W0078-01
60		2001-03	REC6H3-44352-00	REC663-44322-00	REC6H3-44323-00		REC6H3-44315-00	REC663-44366-00	REC90280-03M03	REC6H3-W0078-02
60		2004-05	REC688-44352-03	REC688-44322-00	REC688-44323-00	REC688-44311-01	REC688-44315-00	REC663-44366-00	REC90280-04M04	REC692-W0078-02
C60		1996-01	REC6H3-44352-00	REC663-44322-00	REC6H3-44323-00		REC6H3-44315-00	REC663-44366-00	REC90280-03M03	REC6H3-W0078-02
E60		1995-96	REC6H3-44352-00	REC663-44322-00	REC6H3-44323-00		REC6H3-44315-00	REC663-44366-00	REC90280-03M03	REC6H3-W0078-02
E-60H / E60MH	6K5	1997-00	REC6H3-44352-00	REC663-44322-00	REC6H3-44323-00		REC6H3-44315-00	REC663-44366-00	REC90280-03M03	REC6H3-W0078-02
P60		1991-99	REC6H3-44352-00	REC663-44322-00	REC6H3-44323-00		REC6H3-44315-00	REC663-44366-00	REC90280-03M03	REC6H3-W0078-02
70		1984-03	REC6H3-44352-00	REC663-44322-00	REC6H3-44323-00		REC6H3-44315-00	REC663-44366-00	REC90280-03M03	REC6H3-W0078-02
70		2004-09	REC688-44352-03	REC688-44322-00	REC688-44323-00	REC688-44311-01	REC688-44315-00	REC663-44366-00	REC90280-04M04	REC692-W0078-02
C70		2000-01	REC6H3-44352-00	REC663-44322-00	REC6H3-44323-00		REC6H3-44315-00	REC663-44366-00	REC90280-03M03	REC6H3-W0078-02
C75		1994-99	REC688-44352-03	REC688-44322-00	REC688-44323-00	REC688-44311-01	REC688-44315-00	REC663-44366-00	REC90280-04M04	REC692-W0078-02
E75		1995-00	REC688-44352-03	REC688-44322-00	REC688-44323-00	REC688-44311-01	REC688-44315-00	REC663-44366-00	REC90280-04M04	REC692-W0078-02
P75		1996-99	REC688-44352-03	REC688-44322-00	REC688-44323-00	REC688-44311-01	REC688-44315-00	REC663-44366-00	REC90280-04M04	REC692-W0078-02
75CETO, TLR	67P1>67P9	2003-2011	REC688-44352-03	REC688-44322-00	REC688-44323-00	REC688-44311-01	REC688-44315-00	REC663-44366-00	REC90280-04M04	REC692-W0078-02



			1	2	3	4	5	6	7	KIT
75CETO	67PA>67PE	2012-15	REC688-44352-03	REC688-44322-00	REC688-44323-00	REC688-44311-01	REC688-44315-00	REC663-44366-00	REC90280-04M04	REC692-W0078-02
75A, AE	692>6928 692A>692C	1997-07	REC688-44352-03	REC688-44322-00	REC688-44323-00	REC688-44311-01	REC688-44315-00	REC663-44366-00	REC90280-04M04	REC692-W0078-02
80A, AEO, AEM	6H0>6H01	1997-02	REC688-44352-03	REC688-44322-00	REC688-44323-00	REC688-44311-01	REC688-44315-00	REC663-44366-00	REC90280-04M04	REC692-W0078-02
C80		1997	REC688-44352-03	REC688-44322-00	REC688-44323-00	REC688-44311-01	REC688-44315-00	REC663-44366-00	REC90280-04M04	REC692-W0078-02
85A, AED, AET	688>6882	1997-03	REC688-44352-03	REC688-44322-00	REC688-44323-00	REC688-44311-01	REC688-44315-00	REC663-44366-00	REC90280-04M04	REC692-W0078-02
85A	688	1990	REC682-44352-01	REC682-44322-00	REC682-44323-40		REC682-44315-00	REC682-44365-00	REC90280-03024	REC682-W0078-A1
C85		1989-97	REC688-44352-03	REC688-44322-00	REC688-44323-00	REC688-44311-01	REC688-44315-00	REC663-44366-00	REC90280-04M04	REC692-W0078-02
CV85		1989-91	REC688-44352-03	REC688-44322-00	REC688-44323-00	REC688-44311-01	REC688-44315-00	REC663-44366-00	REC90280-04M04	REC692-W0078-02
90AEO	6H1	1992	REC682-44352-01	REC682-44322-00	REC682-44323-40		REC682-44315-00	REC682-44365-00	REC90280-03024	REC682-W0078-A1
90A, AE, TR, TLR, FE, BET	6H1>6H39 6H1A>6H3F 6H2C>6H2J	1997-15	REC688-44352-03	REC688-44322-00	REC688-44323-00	REC688-44311-01	REC688-44315-00	REC663-44366-00	REC90280-04M04	REC692-W0078-02
B90		1997-99	REC688-44352-03	REC688-44322-00	REC688-44323-00	REC688-44311-01	REC688-44315-00	REC663-44366-00	REC90280-04M04	REC692-W0078-02
C90		1997-01	REC688-44352-03	REC688-44322-00	REC688-44323-00	REC688-44311-01	REC688-44315-00	REC663-44366-00	REC90280-04M04	REC692-W0078-02
100A/ AETO	64W	1996	REC6E5-44352-01	REC61A-44322-02	REC6E5-44323-00-40	REC61A-44311-00	REC6E5-44315-A0		REC90280-04M05	REC6N6-W0078-02
100A/ TLR	64W/ 64W0	1997-01	REC6E5-44352-01	REC6E5-44322-00	REC6E5-44323-00-40	REC61A-44311-00	REC93210-86M38		REC90280-04M05	REC6N6-W0078-02
115B/ BE	6E5/ 6E50/ 6E51	1998-02	REC6E5-44352-01	REC6E5-44322-00	REC6E5-44323-00-40	REC61A-44311-00	REC93210-86M38		REC90280-04M05	REC6N6-W0078-02
115B/ BE/ BETO	6,00E+005	1993-96	REC6E5-44352-01	REC61A-44322-02	REC6E5-44323-00-40	REC61A-44311-00	REC6E5-44315-A0		REC90280-04M05	REC6N6-W0078-02
115BE	6E5	1997	REC6E5-44352-01	REC6E5-44322-00	REC6E5-44323-00-40	REC61A-44311-00	REC93210-86M38		REC90280-04M05	REC6N6-W0078-02
115C	6N6 6N61	2000-02	REC6E5-44352-01	REC6E5-44322-00	REC6E5-44323-00-40	REC61A-44311-00	REC93210-86M38		REC90280-04M05	REC6N6-W0078-02
115CEO/ CETO	6N6	1993-96	REC6E5-44352-01	REC61A-44322-02	REC6E5-44323-00-40	REC61A-44311-00	REC6E5-44315-A0		REC90280-04M05	REC6N6-W0078-02
115CET/ CETO/ TR/ TLR	6N6-6N69 6N6A-6N6E	1997-13	REC6E5-44352-01	REC6E5-44322-00	REC6E5-44323-00-40	REC61A-44311-00	REC93210-86M38		REC90280-04M05	REC6N6-W0078-02
115TXRZ	6N60	2001	REC6E5-44352-01	REC6E5-44322-00	REC6E5-44323-00-40	REC61A-44311-00	REC93210-86M38		REC90280-04M05	REC6N6-W0078-02
C115-115TLR	6N6/6E5	1998-00	REC6E5-44352-01	REC6E5-44322-00	REC6E5-44323-00-40	REC61A-44311-00	REC93210-86M38		REC90280-04M05	REC6N6-W0078-02
C115		1991-92	REC6E5-44352-01	REC6E5-44322-00	REC6E5-44323-00-40	REC61A-44311-00	REC93210-86M38		REC90280-04M05	REC6N6-W0078-02
C115		1993-00	REC6E5-44352-01	REC61A-44322-02	REC6E5-44323-00-40	REC61A-44311-00	REC93210-86M38		REC90280-04M05	REC6N6-W0078-02
P115	62A	1993-96	REC6E5-44352-01	REC61A-44322-02	REC6E5-44323-00-40	REC61A-44311-00	REC93210-86M38		REC90280-04M05	REC6N6-W0078-02
115	6N6/6E5	1984-94	REC6E5-44352-01	REC61A-44322-02	REC6E5-44323-00-40	REC61A-44311-00	REC93210-86M38		REC90280-04M05	REC6N6-W0078-02
130 BETO	6N7/ 6N70/ 6N77	1997-07	REC6E5-44352-01	REC61A-44322-02	REC6E5-44323-00-40	REC61A-44311-00	REC93210-86M38		REC90280-04M05	REC6N6-W0078-02
130TLR	6N7	2000	REC6E5-44352-01	REC61A-44322-02	REC6E5-44323-00-40	REC61A-44311-00	REC93210-86M38		REC90280-04M05	REC6N6-W0078-02
L130BETO	6N4	1993-96	REC6E5-44352-01	REC61A-44322-02	REC6E5-44323-00-40	REC61A-44311-00	REC93210-86M38		REC90280-04M05	REC6N6-W0078-02
L130BETO	6N4/6N40	1997-01	REC6E5-44352-01	REC61A-44322-02	REC6E5-44323-00-40	REC61A-44311-00	REC93210-86M38		REC90280-04M05	REC6N6-W0078-02
130	6L1/6N7	1988-92	REC6E5-44352-01	REC6E5-44322-00	REC6E5-44323-00-40	REC61A-44311-00	REC93210-86M38		REC90280-04M05	REC6N6-W0078-02
130 BETO	6N7	1993-96	REC6E5-44352-01	REC61A-44322-02	REC6E5-44323-00-40	REC61A-44311-00	REC6E5-44315-A0		REC90280-04M05	REC6N6-W0078-02
130 / L130		1997-01	REC6E5-44352-01	REC61A-44322-02	REC6E5-44323-00-40	REC61A-44311-00	REC93210-86M38		REC90280-04M05	REC6N6-W0078-02
130		2002-04	REC6E5-44352-01	REC61A-44322-02	REC6E5-44323-00-40	REC61A-44311-00	REC93210-86M38		REC90280-04M05	REC6N6-W0078-02
L130	6L6/6N4	1989-92	REC6E5-44352-01	REC6E5-44322-00	REC6E5-44323-00-40	REC61A-44311-00	REC93210-86M38		REC90280-04M05	REC6N6-W0078-02
L130	6N4	1993-96	REC6E5-44352-01	REC61A-44322-02	REC6E5-44323-00-40	REC61A-44311-00	REC93210-86M38		REC90280-04M05	REC6N6-W0078-02
L150CETO	6R2 / 6R0	1992-95	REC6E5-44352-01	REC61A-44322-02	REC6G5-44323-00	REC61A-44311-00	REC93210-86M38		REC90280-04M05	REC61A-W0078-A1
D150H	65NO>65N1	2001-02	REC6E5-44352-01	REC61A-44322-02	REC61A-44311-00	REC93210-86M38		REC90280-04M05	REC65N-W0078-A1	
150F/ S150FETO	64C	1996	REC6E5-44352-01	REC6E5-44322-00	REC6E5-44323-00-40	REC61A-44311-00	REC93210-86M38		REC90280-04M05	REC6G5-W0078-A1
150	6R2	1992-09	REC6E5-44352-01	REC61A-44322-02	REC6G5-44323-00	REC61A-44311-00	REC93210-86M38		REC90280-04M05	REC61A-W0078-A1
L150FETO	64G	1996	REC6E5-44352-01	REC6E5-44322-00	REC6E5-44323-00-40	REC61A-44311-00	REC93210-86M38		REC90280-04M05	REC6G5-W0078-A1
L150	6R0	1992-99	REC6E5-44352-01	REC61A-44322-02	REC6G5-44323-00	REC61A-44311-00	REC93210-86M38		REC90280-04M05	REC61A-W0078-A1
P150		1986-91	REC6E5-44352-01	REC6E5-44322-00	REC6E5-44323-00-40	REC61A-44311-00	REC93210-86M38		REC90280-04M05	REC6G5-W0078-A1
P150		1992-99	REC6E5-44352-01	REC61A-44322-02	REC6G5-44323-00	REC61A-44311-00	REC93210-86M38		REC90280-04M05	REC61A-W0078-A1
150/175/ 200ETLN		1984	REC6E5-44352-01	REC6E5-44322-00	REC6E5-44323-00-40	REC61A-44311-00	REC93210-86M38		REC90280-04M05	REC6G5-W0078-A1
PRO V150	6J9	1986-89	REC6E5-44352-01	REC6E5-44322-00	REC6E5-44323-00-40	REC61A-44311-00	REC93210-86M38		REC90280-04M05	REC6G5-W0078-A1
PRO V150	6N9	1990	REC6E5-44352-01	REC6E5-44322-00	REC6E5-44323-00-40	REC61A-44311-00	REC93210-86M38		REC90280-04M05	REC6G5-W0078-A1
PX150		1999	REC6E5-44352-01	REC61A-44322-02	REC6G5-44323-00	REC61A-44311-00	REC93210-86M38		REC90280-04M05	REC61A-W0078-A1
SX150		1999-04	REC6E5-44352-01	REC61A-44322-02	REC6G5-44323-00	REC61A-44311-00	REC93210-86M38		REC90280-04M05	REC61A-W0078-A1
V150		2000-08	REC6E5-44352-01	REC61A-44322-02	REC6G5-44323-00	REC61A-44311-00	REC93210-86M38		REC90280-04M05	REC61A-W0078-A1
VZ150		2001-09	REC6E5-44352-01	REC61A-44322-02	REC6G5-44323-00	REC61A-44311-00	REC93210-86M38		REC90280-04M05	REC61A-W0078-A1
Z150/ LZ150		2001-05	REC6E5-44352-01	REC61A-44322-02	REC6G5-44323-00	REC61A-44311-00	REC93210-86M38		REC90280-04M05	REC61A-W0078-A1
175	6G5	1984-91	REC6E5-44352-01	REC6E5-44322-00	REC6E5-44323-00-40	REC61A-44311-00	REC93210-86M38		REC90280-04M05	REC6G5-W0078-A1
175 BETO	6R3	1992-95	REC6E5-44352-01	REC61A-44322-02	REC6G5-44323-00	REC61A-44311-00	REC93210-86M38		REC90280-04M05	REC61A-W0078-A1
175 DETO	64D	1996	REC6E5-44352-01	REC61A-44322-02	REC6G5-44323-00	REC61A-44311-00	REC93210-86M38		REC90280-04M05	REC61A-W0078-A1
P175	62H	1994-99	REC6E5-44352-01	REC61A-44322-02	REC6G5-44323-00	REC61A-44311-00	REC93210-86M38		REC90280-04M05	REC61A-W0078-A1
VZ175		2001-09	REC6E5-44352-01	REC61A-44322-02	REC6G5-44323-00	REC61A-44311-00	REC93210-86M38		REC90280-04M05	REC61A-W0078-A1
Z175		2001-05	REC6E5-44352-01	REC61A-44322-02	REC6G5-44323-00	REC61A-44311-00	REC93210-86M38		REC90280-04M05	REC61A-W0078-A1
200G	64M	1996	REC6E5-44352-01	REC61A-44322-02	REC6G5-44323-00	REC61A-44311-00	REC93210-86M38		REC90280-04M05	REC61A-W0078-A1
200 FETO	64E	1996	REC6E5-44352-01	REC61A-44322-02	REC6G5-44323-00	REC61A-44311-00	REC93210-86M38		REC90280-04M05	REC61A-W0078-A1
200 CETO	61H	1992-93	REC6E5-44352-01	REC61A-44322-02	REC6G5-44323-00	REC61A-44311-00	REC93210-86M38		REC90280-04M05	REC61A-W0078-A1
200	6G6/6R4	1984-91	REC6E5-44352-01	REC6E5-44322-00	REC6E5-44323-00-40	REC61A-44311-00	REC93210-86M38		REC90280-04M05	REC6G5-W0078-A1
200 BETO	6R4	1992-99	REC6E5-44352-01	REC61A-44322-02	REC61A-44311-00	REC93210-86M38		REC90280-04M05	REC61A-W0078-A1	
L200BETO	6R1	1992-95	REC6E5-44352-01	REC6E5-44322-00	REC6E5-44323-00-40	REC61A-44311-00	REC93210-86M38		REC90280-04M05	REC61A-W0078-A1
L200 FETO	64H	1992-99	REC6E5-44352-01	REC61A-44322-02	REC6G5-44323-00	REC61A-44311-00	REC93210-86M38		REC90280-04M05	REC61A-W0078-A1
LX200		1999-02	REC6E5-44352-01	REC61A-44322-02	REC6G5-44323-00	REC61A-44311-00	REC93210-86M38		REC90280-04M05	REC61A-W0078-A1
P200		1991-99	REC6E5-44352-01	REC61A-44322-02	REC6G5-44323-00	REC61A-44311-00	REC93210-86M38		REC90280-04M05	REC61A-W0078-A1
SX200		1999-05	REC6E5-44352-01	REC61A-44322-02	REC6G5-44323-00	REC61A-44311-00	REC93210-86M38		REC90280-04M05	REC61A-W0078-A1

</

		1	2	3	4	5	6	7	KIT
V200		1998-99 REC6E5-44352-01	REC61A-44322-02	REC6G5-44323-00	REC61A-44311-00	REC93210-86M38		REC90280-04M05	REC61A-W0078-A1
VZ200		2001-04 REC6E5-44352-01	REC61A-44322-02	REC6G5-44323-00	REC61A-44311-00	REC93210-86M38		REC90280-04M05	REC61A-W0078-A1
VZ200		2005-09 REC6E5-44352-01	REC61A-44322-02		REC61A-44311-00	REC93210-86M38		REC90280-04M05	
Z200/ LZ200		2000-10 REC6E5-44352-01	REC61A-44322-02	REC6G5-44323-00	REC61A-44311-00	REC93210-86M38		REC90280-04M05	REC61A-W0078-A1
V6 Special	6G7	1984-86 REC6E5-44352-01	REC6E5-44322-00	REC6E5-44323-00-40	REC61A-44311-00	REC93210-86M38		REC90280-04M05	REC6G5-W0078-A1
V6 Excel	6K7	1987-89 REC6E5-44352-01	REC6E5-44322-00	REC6E5-44323-00-40	REC61A-44311-00	REC93210-86M38		REC90280-04M05	REC6G5-W0078-A1
L225C/ CETO	62K	1994-95 REC6E5-44352-01	REC61A-44322-02	REC6G5-44323-00	REC61A-44311-00	REC93210-86M38		REC90280-04M05	REC61A-W0078-A1
225 C	62J	1994-95 REC6E5-44352-01	REC61A-44322-02	REC6G5-44323-00	REC61A-44311-00	REC93210-86M38		REC90280-04M05	REC61A-W0078-A1
225 DET / DETO	64F	1996 REC6E5-44352-01	REC61A-44322-02	REC6G5-44323-00	REC61A-44311-00	REC93210-86M38		REC90280-04M05	REC61A-W0078-A1
225 BET / BETO	6R5	1991-95 REC6E5-44352-01	REC61A-44322-02	REC6G5-44323-00	REC61A-44311-00	REC93210-86M38		REC90280-04M05	REC61A-W0078-A1
225 (2.6L)		1992-97 REC6E5-44352-01	REC61A-44322-02	REC6G5-44323-00	REC61A-44311-00	REC93210-86M38		REC90280-04M05	REC61A-W0078-A1
225 1/5 (3.1L)		1994-99 REC6E5-44352-01	REC61A-44322-02	REC6G5-44323-00	REC61A-44311-00	REC93210-86M38		REC90280-04M05	REC61A-W0078-A1
LX225/ SX225		2000-03 REC6E5-44352-01	REC61A-44322-02	REC6G5-44323-00	REC61A-44311-00	REC93210-86M38		REC90280-04M05	REC61A-W0078-A1
VZ25		1998-99 REC6E5-44352-01	REC61A-44322-02	REC6G5-44323-00	REC61A-44311-00	REC93210-86M38		REC90280-04M05	REC61A-W0078-A1
VX225		2000-04 REC6E5-44352-01	REC61A-44322-02	REC6G5-44323-00	REC61A-44311-00	REC93210-86M38		REC90280-04M05	REC61A-W0078-A1
VZ225		2003-09 REC6E5-44352-01	REC61A-44322-02		REC61A-44311-00	REC93210-86M38		REC90280-04M05	
250AET/ AETO/ L250A	61A/61B	1990-96 REC6E5-44352-01	REC61A-44322-02	REC6G5-44323-00	REC61A-44311-00	REC93210-86M38		REC90280-04M05	REC61A-W0078-A1
250 ETD	61A	1990 REC6E5-44352-01	REC61A-44322-02	REC6G5-44323-00	REC61A-44311-00	REC93210-86M38		REC90280-04M05	REC61A-W0078-A1
250 B	61A	1995 REC6E5-44352-01	REC61A-44322-02	REC6G5-44323-00	REC61A-44311-00	REC93210-86M38		REC90280-04M05	REC61A-W0078-A1
250/ L250		1990-96 REC6E5-44352-01	REC61A-44322-02	REC6G5-44323-00	REC61A-44311-00	REC93210-86M38		REC90280-04M05	REC61A-W0078-A1
L250 /S250		1997-99 REC6E5-44352-01	REC61A-44322-02	REC6G5-44323-00	REC61A-44311-00	REC93210-86M38		REC90280-04M05	REC61A-W0078-A1
VX250		2002-04 REC6E5-44352-01	REC61A-44322-02	REC6G5-44323-00	REC61A-44311-00	REC93210-86M38		REC90280-04M05	REC61A-W0078-A1
VZ250		2003-09 REC6E5-44352-01	REC61A-44322-02		REC61A-44311-00	REC93210-86M38		REC90280-04M05	
Z300 /LZ300		2006 REC6E5-44352-01	REC61A-44322-02		REC61A-44311-00	REC93210-86M38		REC90280-04M05	REC61A-W0078-A1
VZ300		2004-09 REC6E5-44352-01	REC61A-44322-02		REC61A-44311-00	REC93210-86M38		REC90280-04M05	
LZ250DETOX	60V5/60W5	2007 REC6E5-44352-01	REC61A-44322-02	REC6P2-44323-00	REC61A-44311-00	REC93210-86M38		REC90280-04M05	REC6P2-W0078-00
LZ/ Z300AETOX	6D04/6D14	2007 REC6E5-44352-01	REC61A-44322-02	REC6P2-44323-00	REC61A-44311-00	REC93210-86M38		REC90280-04M05	REC6P2-W0078-00

ANODOS

REF	OEM
ZN REC61A-11325-00	61A-11325-00
AL REC61A-11325-00AL	



REF	OEM
ZN REC63D-45251-01	63D-45251-01
AL REC63D-45251-01AL	



REF	OEM
ZN REC63P-11325-11	63P-11325-11
AL REC63P-11325-11AL	



REF	OEM
ZN REC6AW-1132R-00	6AW-1132R-00
AL REC6AW-1132R-00AL	



REF	OEM
ZN REC6U0-45251-01	6U0-45251-01
AL REC6U0-45251-01AL	



ANODES

REF	OEM
ZN REC61N-45251-01	61N-45251-01
AL REC61N-45251-01AL	



REF	OEM
ZN REC63P-11325-01	63P-11325-01
AL REC63P-11325-01AL	



REF	OEM
ZN REC66M-45371-00	66M-45371-00
AL REC66M-45371-00AL	



REF	OEM
ZN REC6AW-1132S-00	6AW-1132S-00
AL REC6AW-1132S-00AL	



REF	OEM
ZN REC6U4-45373-01	6U4-45373-01
AL REC6U4-45373-01AL	



REF	OEM
ZN REC6AW-1132T-00	6AW-1132T-00
AL REC6AW-1132T-00AL	



REF	OEM
ZN REC6AW-45251-00	6AW-45251-00
AL REC6AW-45251-00AL	



REF	OEM
ZN REC6AW-1132U-00	6AW-1132U-00
AL REC6AW-1132U-00AL	



REF	OEM
ZN REC6AW-45373-00	6AW-45373-00
AL REC6AW-45373-00AL	



REF	OEM
ZN REC6K1-45371-00	6K1-45371-00
AL REC6K1-45371-00AL	



REF	OEM
ZN REC6AW-45619-00	6AW-45619-00
AL REC6AW-45619-00AL	



REF	OEM
ZN REC6K1-45371-02	6K1-45371-02
AL REC6K1-45371-02AL	



REF	OEM
ZN REC6BL-11325-00	6BL-11325-00
AL REC6BL-11325-00AL	



REF	OEM
ZN REC6N0-WG525-00	6N0-WG525-00
AL REC6N0-WG525-00AL	



REF	OEM
ZN REC6E0-45251-12	6E0-45251-12
AL REC6E0-45251-12AL	



REF	OEM
ZN REC6T4-45836-00	6T4-45836-00
AL REC6T4-45836-00AL	



REF	OEM
ZN REC6E5-45251-00	6E5-45251-00
AL REC6E5-45251-00AL	



REF	OEM
ZN REC6T5-45251-00	6T5-45251-00
AL REC6T5-45251-00AL	



REF	OEM
ZN REC6E5-45371-10	6E5-45371-10
AL REC6E5-45371-10AL	



REF	OEM
ZN REC99999-03946	99999-03946
AL REC99999-03946AL	



REF	OEM
ZN REC6T5-45371-00	6T5-45371-00
AL REC6T5-45371-00AL	



REF	OEM
ZN REC6T5-45373-00	6T5-45373-00
AL REC6T5-45373-00AL	



REF	OEM
ZN REC6U3-45251-01	6U3-45251-01
AL REC6U3-45251-01AL	



REF	OEM
ZN REC6U4-45251-01	6U4-45251-01
AL REC6U4-45251-01AL	



REF	OEM
ZN REC63P-11325-21	63P-11325-11
AL REC63P-11325-21AL	



REF	OEM
ZN REC679-45251-00	679-45251-00
AL REC679-45251-00AL	



REF	OEM
ZN REC676-11325-00	676-11325-00
AL REC676-11325-00AL	



REF	OEM
ZN REC679-45371-00	679-45371-00
AL REC679-45371-00AL	



REF	OEM
ZN REC6E8-45251-02	6E8-45251-02
AL REC6E8-45251-02AL	



REF	OEM
ZN REC682-11325-00	682-11325-00
AL REC682-11325-00AL	



REF	OEM
ZN REC6G8-45251-01	6G8-45251-01
AL REC6G8-45251-01AL	



REF	OEM
ZN REC688-11325-00	688-11325-00
AL REC688-11325-00AL	



REF	OEM
ZN RECN51-11325-01	N51-11325-01



REF	OEM
ZN REC689-11325-00	689-11325-00
AL REC689-11325-00AL	



REF	OEM
ZN REC6CE-45373-00	6CE-45373-00



REF	OEM
ZN REC68V-11325-02	68V-11325-02
AL REC68V-11325-02AL	



REF	OEM
ZN REC6AH-45251-00	6AH-45251-00
AL REC6AH-45251-00AL	



REF	OEM
ZN REC69L-45371-00	69L-45371-00
AL REC69L-45371-00AL	



REF	OEM
ZN REC6AW-11325-00	6AW-11325-00
AL REC6AW-11325-00AL	



REF	OEM
ZN REC6AW-1132M-00	6AW-1132M-00
AL REC6AW-1132M-00AL	



REF	OEM
ZN REC6AW-1132L-00	6AW-1132L-00
AL REC6AW-1132L-00AL	



REF	OEM
ZN REC6AW-1132P-00	6AW-1132P-00
AL REC6AW-1132P-00AL	



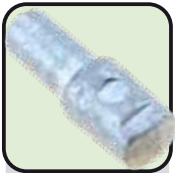

REC66M-11325-00
REC66M-11325-00AL



REC67F-11325-00
REC67F-11325-00AL

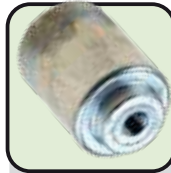

REC68V-11325-01
REC68V-11325-01AL



REC6J8-11325-00
REC6J8-11325-00AL



REC62Y-11325-00
REC62Y-11325-00AL

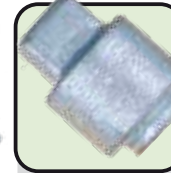

REC67F-11325-01
REC67F-11325-01AL

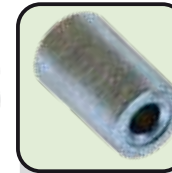

REC68T-11325-00
REC68T-11325-00AL

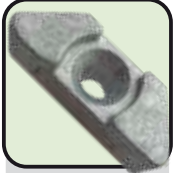

REC6E5-11325-00
REC6E5-11325-00AL

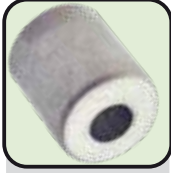

REC6G8-11325-00
REC6G8-11325-00AL



REC676-45251-00
REC676-45251-00AL

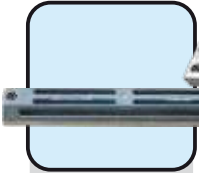

REC6H1-45251-01
REC6H1-45251-01AL

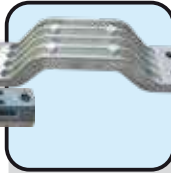

REC6G5-45251-02
REC6G5-45251-02AL

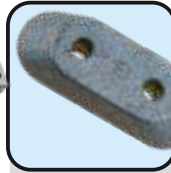

REC65W-45251-00
REC65W-45251-00AL

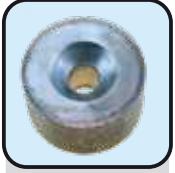

REC688-45251-01
REC688-45251-01AL

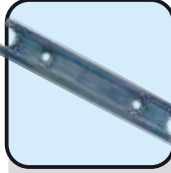

REC6H1-45251-03
REC6H1-45251-03AL



REC664-45371-01
REC664-45371-01AL



REC67F-45371-00
REC67F-45371-00AL



REC6J9-45371-01
REC6J9-45371-01AL



REC6E5-45371-01
REC6E5-45371-01AL

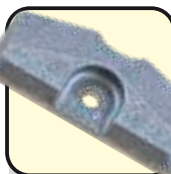

REC6L5-45251-03
REC6L5-45251-03AL

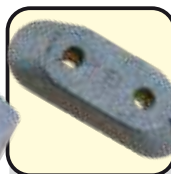

REC65W-45251-00
REC65W-45251-00AL



REC6CE-45373-00
REC6CE-45373-00AL



REC41107-ZV5-000
REC41107-ZV5-000AL



REC6E8-45251-00
REC6E8-45251-00AL



REC67C-45371-00
REC67C-45371-00AL



REC68T-45251-00
REC68T-45251-00AL



REC67C-45251-00
REC67C-45251-00AL

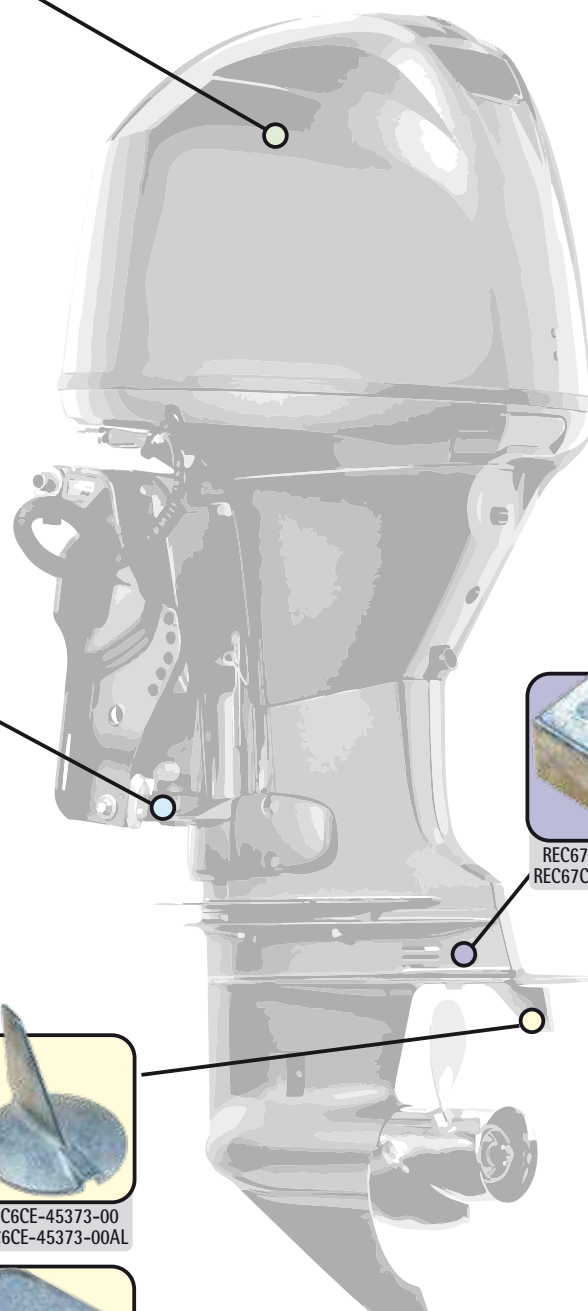

	MOTOR ENGINE	SOPORTE BRACKET	COLA GEAR CASE	TRIM TAB
9.9D/ 15D/ F8A,B/ F9.9A,B				REC6E8-45251-00 REC6E8-45251-00AL
20C,D,M/ F20F,G,M/ F25G,M/ 25D,Q, M,N,J/ 30A,E,D,M/ 40(C)(E) V,M,X- Y,N,H/ F40A/ F45A/ 50H,E,D/ F(T)50A,B,T/				REC41107-ZV5-000 REC41107-ZV5-000AL
20D,M/ 25B,M,N,J,V/ 30G,D,E,H/ E30H/ F45A/ F50A,B/ 225B,C,F,G/ 250A,B,T	REC6J8-11325-00 REC6J8-11325-00AL			
25B,Q/ 40H,Q/ 50D,G/ 55B/ E60H/ 60F,T/ 70B,T/ 75A,C,T/ F75B,T/ 80A/ F80A,B,D,T/ 90A,T/ F100D,F/ 85A/ F100A,T/ F115B/ F130A		REC6H1-45251-03 REC6H1-45251-03AL		
40H/ 50D/ 60F/ 70B/ 80A/ 90A		REC6H1-45251-01 REC6H1-45251-01AL		
40H, 50D, 60F, 70B, 80A, 90A(-1989)		REC688-45251-01 REC688-45251-01AL		
40(E) X,M,J,Q	REC676-45251-00 REC676-45251-00AL			
60F, 70B, 75A/C, PR075, 80A, 85A, 90A, FT50B(-2000), FTC/G, FT50J, FT60B/D, FT60G, F70A, F80A/B, F100A/D				REC67F-45371-00 REC67F-45371-00AL
100A, 115A/B/C, 130B, 140A/B, F100B/F, F115A/B, 150A, 175A, 200A, PROV100				REC6E5-45371-01 REC6E5-45371-01AL
150A, 175A, 200A(1998+), 150C/F, 175B/D, 200B/F/G, 225A/B/D/F, PROV200, F150A, Z150P/Q, Z175G/H, Z200N, F200F, F(L)200G				REC6J9-45371-01 REC6J9-45371-01AL
F2.5A, 2B, 3A, F4A, 4A, 5C (1989+), F4B, F5A, F6C				REC6L5-45251-03 REC6L5-45251-03AL
F2.5B,M/ F4B,M/ F5A,M/ F6A,B,M,L/ F(T)8B,C,A,M,D,P,F,G/ F(T)9.9F,M,G,E,H,- J,L,A/ F13.5B/ F15C,M/ F20G,E,P,M,S,L,D,F/ F(T)25 A,F,D,M,G/ F30B/ F40D,H,F,A,G/ F(T)50D,F,H,B,J,G/ F(T)60C,A,B,F,D,G/ F70A/ F80D/ F100F/ F115B/ F130A/ F(XF)425A,S/ F(XF)375A,S	REC6G8-11325-00 REC6G8-11325-00AL			
F6A,B,M/ F8C,F,M/ F9.9F,M,J				REC68T-45251-00 REC68T-45251-00AL
F6A,B,M/ F8(T)C,M,D/ F150A,B,C,D,G,T/ F175A,C/ F200B,C,F,G/ F225B,C,F,H/ F250B,C,D,L/ F300A,B,C,D	REC68T-11325-00 REC68T-11325-00AL			
FT8D, FT9.9D, F15A/C, F20A/B, F25A/G(PT model), FT25B, F30A, 30D, F40B/C, 40X/V, FT50C, 50H, F60A, FT60B, F70A, 4A, 5C, F8A/B/, 6C/D, 8C, F9.9A/B(1989+), 9.9D, 15		REC65W-45251-00 REC65W-45251-00AL		REC65W-45251-00 REC65W-45251-00AL
F9.9C/ FT9.9D/ F13.5A/ F15A,E,M,P/ Z250D,F,T/ Z300A,T	REC66M-11325-00 REC66M-11325-00AL			
F9.9(T) C,H/ F13.5A,B/ F15A,E,C,P,M/ F20B,M/ F75B,T/ F80A,B/ 100A/ F100A,B,D/ 115C,T/ F115A,B,T/ 130B/T/ 140A,B/ Z150P,T,Q/ 150A,C,F,T/ F150C,G/ F175A,B,C/ Z175G,T/ 175D/ Z200N,P,T/ 200A,B,F/ 225B,D/ F200A,B,C,F,G,T/ 200A,C,E,F,G/ F225A,B,C,T/ F250A,B,T/ F300A,T/ F350A,C,T F20A,D/ F(T)25A,B,E,M,D,F,T/ F30A,B,M,T/ F45A/ F(T)50B,C,A,D,F,H,J,T/ F40A,B,C,D,E,F,G,M,H / F(T)60A,B,C,D,F,G,T/ F70A/ Z150P,T,Q/ Z175G,T/ Z200N,P,T/ Z250D,F,G/ 250A/	REC6E5-11325-00 REC6E5-11325-00AL			
F20G,M/ 20C,D,M/ 25D,J,N,M,Q/ F25G,M/ 30A,D,E/ 40N,H,V,Y/ C40M/ 40X/ E40M,X/ 50D,H/ F50A/ F45A/				REC664-45371-01 REC664-45371-01AL
F(T)25A,B,E,F,T/ F30A,B,E,M,T/ F40A,B,C,D,E,F,H,T/ F50A,D,H,F,T/ F60A,B,C,F,T				REC67C-45371-00 REC67C-45371-00AL
FT25F, F30B, F40F, F60A/C, FT60B, 40V/X, 50H, F40A, F50A/B(-1999), F50H, F60F			REC67C-45251-00 REC67C-45251-00AL	
F75B,T/ F80A,B/ F100A,B,C,D/ F115A,T/ F150A,T/ F200A,T/ F225A,T	REC68V-11325-01 REC68V-11325-01AL			
F80A,T/ F100A,T/ F115A,T/ F200A,T/ F225A,T/ Z250D,F/ Z300A,T	REC67F-11325-00 REC67F-11325-00AL			
F80C/ 100A,T/ F100B/ 115B,C,T/ F115A,T/ 130B/ 140B/ 150A,C,F,T/ F150A,B,D,F,T/ Z150P,T/ 175A,B,D,F/ F200A,C/ 200A,B,C,F,G,T/ F225A,B,C,F,H,T/ 225A,B,D,G/ Z250D,F,T/ F250A,B,C,D,L,T/ 250A,G,B/ Z200N,P,T/ Z300A,T/ F300A,B,C,T/ F350A,T F80A,B,C/ F100B,D/ F115A,B/ F130A/ F150A,B,C,D,F,G/ F175A,C/ F200A,B,F,G/ F225A,B,C,F,H/ Z250D,F,T/ F250A,B,C,D,L,T/ Z300A,T/ F300A,B,C,D/ F350A,C		REC6G5-45251-02 REC6G5-45251-02AL		
F200A,B,C,T/ F225A,B,C,F,H,L,T/ 225C,F/ 250A,B,E,G,T/ F250A,B,C,D,T/ F300A,B,C,D	REC67F-11325-01 REC67F-11325-01AL			
F200A,B,C,T/ F225A,B,C,F,H,L,T/ 225C,F/ 250A,B,E,G,T/ F250A,B,C,D,T/ F300A,B,C,D				REC6CE-45373-00 REC6CE-45373-00AL

KITS

REF	
AL	RECKITY40-50AL
MG	RECKITY40-50M
ZN	RECKITY40-50ZN



REF	
AL	RECKITY40-60AL
MG	RECKITY40-60M
ZN	RECKITY40-60ZN



REF	
AL	RECKITY80-100AL
MG	RECKITY80-100M
ZN	RECKITY80-100ZN



REF	
AL	RECKITY60-90AL
MG	RECKITY60-90M
ZN	RECKITY60-90ZN



REF	
AL	RECKITY150-200AL
MG	RECKITY150-200M
ZN	RECKITY150-200ZN



REF	
AL	RECKITY150-200CRAL
MG	RECKITY150-200CRM
ZN	RECKITY150-200CRZN



REF	
AL	RECKITY200-250AL
MG	RECKITY200-250M
ZN	RECKITY200-250ZN



REF	
AL	RECKITY200-300AL
MG	RECKITY200-300M
ZN	RECKITY200-300ZN



REF	
AL	RECKITY300-350AL
MG	RECKITY300-350M
ZN	RECKITY300-350ZN



REF	
AL	RECKITY300-350XPAL
MG	RECKITY300-350XPM
ZN	RECKITY300-350XPZN



PARTES DEL MOTOR

ENGINE PARTS

DESPIECE MOTOR DE 4 TIEMPOS

ENGINE PARTS 4 STROKES

4T F2.5 AMH/MLH/MSH/MHA (2003+)
STROKES

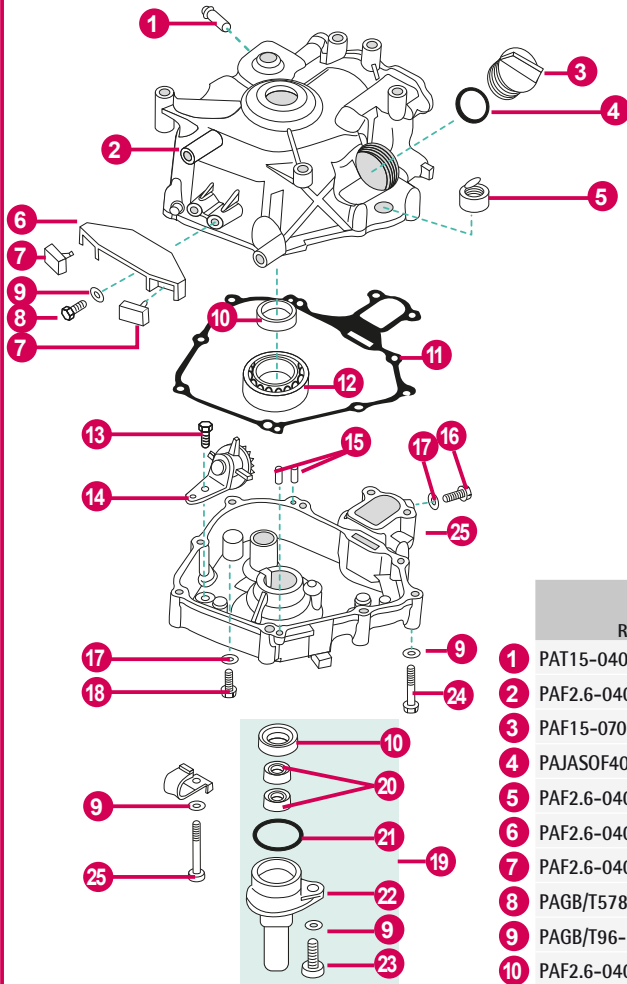

	REF	OEM		UN.	
1	PAT15-04010202	6H1-14485-00	PIPA DE AGUA	PIPE, WATER	1
2	PAF2.6-04010100	69M-E1311-00-1	CARCASA MOTOR	CRANK CASE	1
3	PAF15-07050004	69M-E5363-00	TAPÓN ACEITE	PLUG, OIL	1
4	PAJASOF40431-025	93210-24M79	ARO TÓRICO	O-RING	1
5	PAF2.6-04010102	69M-15361-00	INDICADOR NIVEL	GAUGE, LEVEL	1
6	PAF2.6-04000008	69M-G2743-00	SOPORTE MOTOR	BRACKET, DAMPER	1
7	PAF2.6-04000009	6G8-44532-00	GOMA SOPORTE	RUBBER BLOCK, DAMPER	2
8	PAGB/T5783-M6X20	97095-06020	TORNILLO	SCREW	2
9	PAGB/T96-6	92995-06600	ARANDELA	WASHER	11
10	PAF2.6-04010001	93102-20108	RETÉN	OIL SEAL	2
11	PAF2.6-04000004	69M-11351-A0	JUNTA CÁRTER	CRANK CASE COMPLEX GASKET	1
12	PAGB/T276-62/22/P6	93306-272Y2	RODAMIENTO	BALL BEARING	1
13	PAGB/T5783-M6X12	95817-06012	TORNILLO	SCREW	1
14	PAF2.6-04050100	69M-E3102-00	PIÑÓN	GEAR UNIT ASSY	1
15	PAF15-00000013	93604-12M07	PIN	PIN	2
16	PAGB/T5783-M8X14	97095-08014	TORNILLO	SCREW	1
17	PAF4-04000006	90201-08818-00	ARANDELA	WASHER	2
18	PAF4-04000001	90105-08M76	TORNILLO DRENAJE	BOLT, DISCHARGING OIL	1
19	PAF2.6-04060000	69M-E5396-00-5B	RETÉN Y CUERPO	OIL SEAL SHELL ASSY	1
20	PAF2.6-04060002	93210-09004	RETÉN	OIL SEAL	2
21	PAF4-04060002	93210-35537	ARO TÓRICO	O RING	1
22	PAF2.6-04060001	69M-E5396-00	CUERPO DEL RETÉN	SHELL, OIL SEAL	1
23	PAGB/T5783-M5X12	90465-08M99	TORNILLO	SCREW	1
24	PAGB/T5783-M5X12	97013-06045	TORNILLO	SCREW	8
25	PAF2.6-04050001	69M-E5111-00-1S	CARTER	CRANKCASE COVER	1

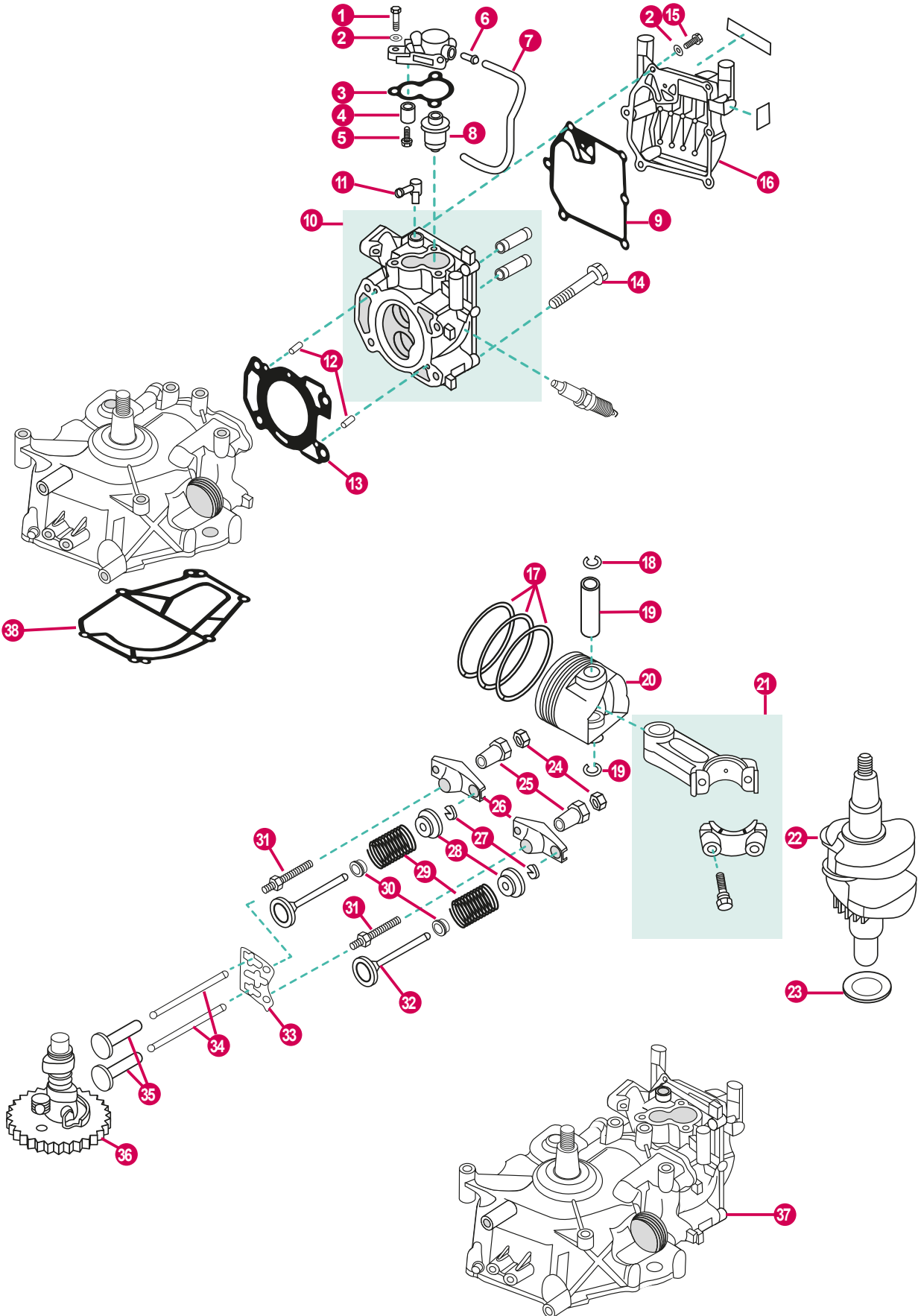

	REF	OEM			UN.
1	PAGB/T5783-M6X20	97095-06020	TORNILLO	SCREW	3
2	PAGB/T96-6	92995-06600	ARANDELA	WASHER	9
3	PAF4-04000011	68D-E2414-A0	JUNTA TAPA TERMOSTATO	GASKET, THERMOSTAT COVER	1
4	PAF4-04070003	68D-E1325-00	ÁNODO	ANODE	1
5	PAGB/T818-M5X25	97880-05025	TORNILLO	SCREW	1
6	PAF4-04010102	650-24378-00	PIPA	PIPE, JOINT	1
7	PAF2.6-04000007	90445-09808	TUBO DE AGUA	WATER TUBE	1
8	REC6AH-12411-00	69M-12411-01	TERMOSTATO	THERMOSTAT	1
9	PAF2.6-04000005	69M-11193-A0	JUNTA TAPA BALANCINES	GASKET, CYLINDER COVER	1
10	PAF2.6-04040100	69M-E1111-00-1S	CULATA COMPLETA	CYLINDER HEAD ASSY	1
11	PAF15-04000005	676-11372-00	NIPLE	NIPPLE	1
12	PAF15-00000013	93604-12M07	PIN	PIN, DOWEL	2
13	PAF2.6-04000001	69M-11181-00	JUNTA CULATA	GASKET, CYLINDER HEAD	1
14	PAF4-04000034	90105-08M36	TORNILLO	SCREW	4
15	PAGB/T5783-M6X16	90105-06039	TORNILLO	SCREW	6
16	PAF2.6-04000006	69M-E1191-00-1S	TAPA BALANCINES	COVER, CYLINDER HEAD	1
17	REC69M-E1603-01	69M-E1603-01	KIT SEGMENTOS	PISTON RING KIT	1
18	PAF2.6-04020006	93450-13130	CIRCLIP	CIRCLIP	2
19	PAF2.6-04020005	69M-E1633-00	PIN, PISTÓN	PIN, PISTON	1
20	PAF2.6-04020001	69M-E1631-01-96	PISTÓN	PISTON	1
21	PAF2.6-04020100	69M-11650-00	BIELA	ROD, CONNECTING	1
22	PAF2.6-04030000	69M-11400-00	CIGÜEÑAL	CRANK ASSY	1
23	PAF2.6-04000003	90201-23008	ARANDELA	WASHER	1
24	PA166F-010011	7FK-12158-00	TUERCA	LOCK NUT	2
25	PA166F-010010	7FK-12165-00	TUERCA BALANCÍN	PIVOT, ROCKER ARM	2
26	PA166F-010009	67D-12151-00	BALANCÍN	ARM, VALVE ROCKER	2
27	PAF8-05030007	7NJ-12118-00	SEGURO DE VÁLVULA	CLAMP, VALVE	2
28	PAF8-05030006	7NJ-12117-00	RETÉN DE RESORTE	SPRING, VALVE RETAINER	2
29	PAF4-04080008	68D-E2113-00	MUELLE DE VÁLVULA	SPRING, VALVE STEM	2
30	PAF166-010003	51Y-12119-00	RETÉN DE VÁLVULA	SEAT, VALVE STEM	2
31	PA166F-010008	67D-12157-00	TORNILLO BALANCÍN	BOLT, ROCKER ARM	2
32	PA166F-010001	67D-12111-00	VÁLVULA ADMISIÓN	VALVE, INTAKE	1
33	PAF2.6-04040001	69M-E2155-00	PLETINA EMPUJADORES	PLATE, PUSH ROD	1
34	PAF2.6-04000002	69M-12154-00	VARILLA EMPUJADOR	ROD, VALVE PUSH	2
35	PA166F-000001	JA9-12153-00	EMPUJADOR	LIFTER, VALVE	2
36	PAF2.6-04000100	69M-12170-01	ÁRBOL DE LEVAS	CAMSHAFT ASSY	1
37	POWERHEAD2.6	69M-WE0090-01-1S	MOTOR	POWER HEAD	1
38	PAF2.6-00000003	69M-45113-A0	JUNTA BASE MOTOR	GASKET ENGINE	1

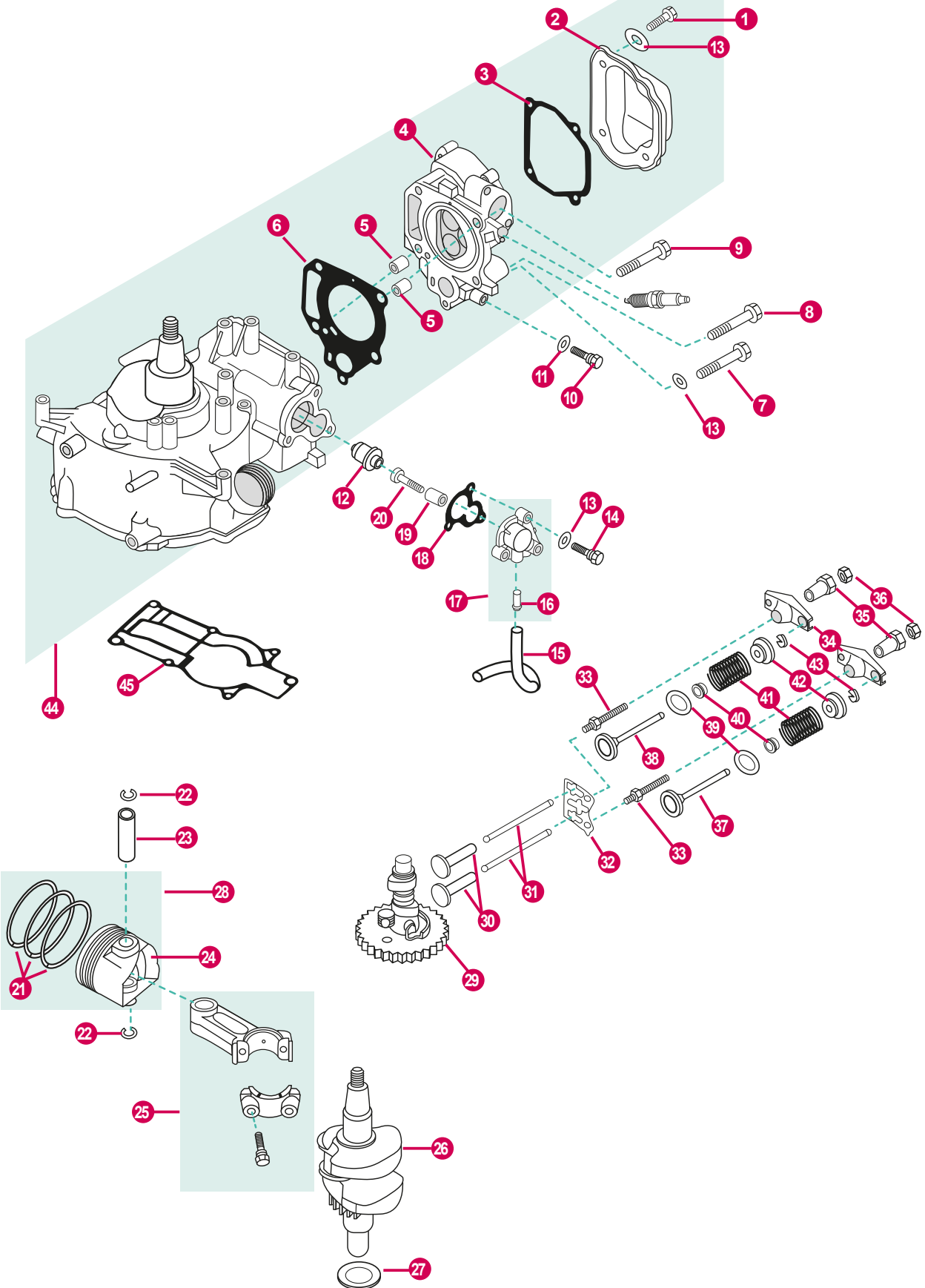

	REF	OEM			UN.
1	PAGB/T5783-M6X16	90105-06M14	TORNILLO	SCREW	4
2	PAF4-04000018	67D-11191-00	TAPA BALANCINES	COVER, CYLINDER HEAD	1
3	PAF4-04000017	68D-E1193-A0	JUNTA TAPA	GASKET, COVER	1
4	PAF4-04080101	68D-E1111-10-1S	CULATA	CYLINDER, HEAD	1
5	PAF4-04000003	99510-10114	PIN	PIN, HOLLOW	2
6	PAF4-04000014	67D-11181-A0	JUNTA CULATA	GASKET, CYLINDER HEAD	1
7	PAGB/T5782-M6X45	90105-06M25	TORNILLO	SCREW	1
8	PAF4-04000034	90105-08M36-00	TORNILLO	SCREW	3
9	PAF4-04000033	90105-08046-00	TORNILLO	SCREW	1
10	PAGB/T5783-M8X14	97095-08014-00	TORNILLO	SCREW	1
11	PAF4-04000006	90430-08800-00	ARANDELA	WASHER, PLATE	1
12	REC6AH-12411-00	69M-12411-01	TERMOSTATO	TEHRMOSTAT	1
13	PAGB/T96-6	92995-06600	ARANDELA	WASHER, PLATE	8
14	PAGB/T5783-M6X20	97095-06020-00	TORNILLO	SCREW	3
15	PAF4-04000012	90445-09807	TUBO	PIPE, RETURN	1
16	PAF4-04010102	650-24378-00	PIPA DE AGUA	PIPE, WATER	1
17	PAF4-04070100	68D-E2413-001S	TAPA TERMOSTATO COMPLETA	COVER ADN SPLIE WATER ASSY	1
18	PAF4-04000011	68D-E2414-A0	JUNTA TAPA TERMOSTATO	GASKET, THERMOSTAT	1
19	PAF4-04070003	68D-E1325-00	ÁNODO	ANODE	1
20	PAGB/T818-M5X25	97880-05025-00	TORNILLO	SCREW, PANHEAD	1
21	REC68D-E1603-00	68D-E1603-00	KIT SEGMENTOS DE PISTÓN	PISTON RING KIT	1
22	PAF4-04020006	93450-14088	CIRCLIP	CIRCLIP	2
23	PAF4-04020005	68D-E1633-00	PIN, PISTÓN	PIN, PISTON	1
24	PAF4-04020001	68D-E1631-00-96	PISTÓN	PISTON	1
25	PAF4-04020100	67D-11650-00	BIELA	ROD, CONNECTING	1
26	PAF4-04030000	67D-11400-00	CIGÜEÑAL	CRANK ASSY	1
27	PAF4-04000004	90201-266P2	ARANDELA	WASHER, PLATE	1
28	PAF4-04020200	68D-E1631-00-96	PISTÓN	PISTON ASSY	1
29	PAF4-04040000	68D-E2170-00	ÁRBOL DE LEVAS	CAMSHAFT ASSY	1
30	PA166F-000001	JA9-12153-00	EMPUJADOR DE VÁLVULA	LIFTER, VALVE PUSH	2
31	PAF4-04000015	67D-12154-00	VARILLA EMPUJADOR DE VÁLVULA	ROD, VALVE PUSH	2
32	PAF4-04080009	68D-E2155-00	PLETINA EMPUJADORES	PLATE, PUSH ROD	1
33	PA166F-010008	67D-12157-00	TORNILLO	SCREW	2
34	PA166F-010009	67D-12151-00	BALANCÍN	VALVE ROCKER	2
35	PA166F-010010	7FK-12165-00	TUERCA BALANCÍN	PIVOT, ROCKER ARM	2
36	PA166F-010011	7FK-12158-00	TUERCA	LOCKNUT	1
37	PAF4-04080005	67D-12111-00	VÁLVULA ADMISIÓN	VALVE, INTAKE	1
38	PAF4-04080006	67D-12121-00	VÁLVULA ESCAPE	VALVE, EXHAUST	1
39	PAF4-04080007	68T-12116-00	ARANDELA ASIENTO	SEAT, VALVE SPRING	2
40	PAF166-010003	51Y-12119-00	RETÉN DE VÁLVULA	SEAT, VALVE STEM	2
41	PAF4-04080008	68D-E2113-00	MUELLE	SPRING, VALVE INNER	2
42	PAF8-05030006	7NJ-12117-00	RETÉN RESORTE	SPRING, VALVE RETAINER	2
43	PAF8-05030007	7NJ-12118-00	SEGURO DE VÁLVULA	CLAMP, VALVE	2
44	PAF4-04000000	680-WE090-11-15	MOTOR	POWER HEAD 4-5	1
45	PAF4-00000006	67D-45113-A0	JUNTA BASE MOTOR	GASKET ENGINE	1

4T F4A/MSHAC/AMH/MLHB-S/MH/MLHE (2002-09)
STROKES

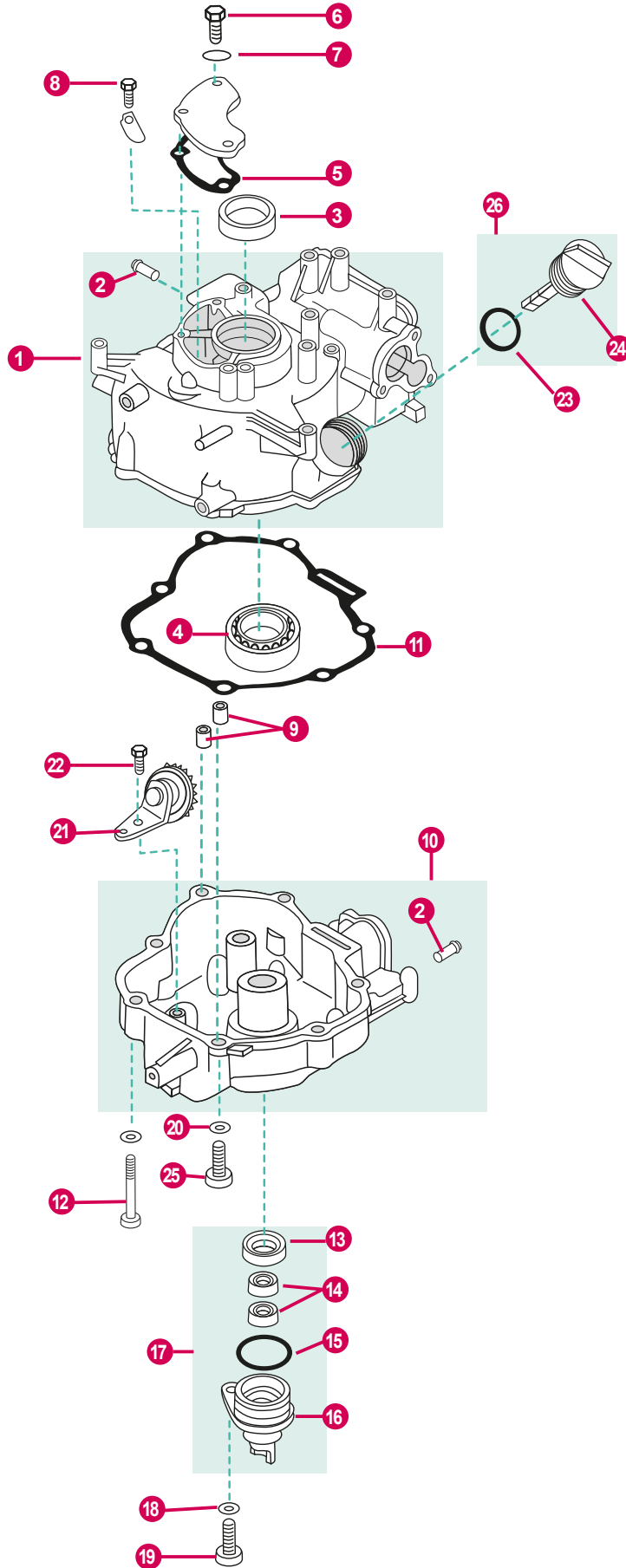

	REF	OEM			UN.
1	PAF4-04010100	68D-E1311-02-15	CARCASA DE MOTOR	CRANK CASE	1
2	PAF4-04010102	650-24378-00	PIPA DE AGUA	PIPE, WATER	2
3	PAF4-04010004	93102-25090	RETÉN	OIL SEAL	1
4	PAGB/T276-6004C2	93306-205YD	RODAMIENTO	BALL BEARING	1
5	PAF4-04000009	68D-E1169-A0	JUNTA	BREATHER GASKET	1
6	PAGB/T5783-M6X14	90119-06M80-00	TORNILLO	SCREW	3
7	PAGB/T96-6	92885-06600	ARANDELA	WASHER	3
8	PAGB/T818-M4X6	98503-04066-00	TORNILLO	SCREW	1
9	PAF4-04000003	99510-10114	PIN	HOLLOWPIN	2
10	PAF4-04050200	68D-E5111-00-1S	CARTER	COVER, CRANK CASE	1
11	PAF4-04000002	68D-11351-A0	JUNTA CARTER	CRANK CASE COMPLEX	1
12	PAGB/T5787-1986	97575-08550-00	TORNILLO	SCREW	7
13	PAF2.6-04010001	93102-20108	RETÉN	OIL SEAL	1
14	PAF4-04060004	93102-10004	RETÉN	OIL SEAL	2
15	PAF4-04060002	93210-35537	TÓRICA	O-RING	1
16	PAF4-04060001	68D-E5396-00-5B	CUERPO DEL RETÉN	SHELL, OIL SEAL	1
17	PAF4-04060000	6EE-E5396-00-CA	CUERPO RETÉN COMPLETO	OIL SEAL, SHELL ASSY	1
18	PAGB/T97.1-8	92955-08600-00	ARANDELA	WASHER, PLATE	8
19	PAGB/T5783-M8X20	97095-08020-00	TORNILLO	BOLT, HEXAGON	1
20	PAF4-04000006	90201-08818	ARANDELA	WASHER	1
21	PAF4-04050100	68D-E3102-00	PIÑÓN COMPELTO	GEAR UNIT ASSY	1
22	PAGB/T5783-M6X12	95817-06012-00	TORNILLO	SCREW	1
23	PAJASOF40435-022	93210-24M79	TÓRICA	O-RING	1
24	PAF4-04000007	68D-E5362-00	TAPÓN MEDIDOR NIVEL	PLUG WITH DIPSTICK	1
25	PAF4-04000001	97095-08020-00	TORNILLO DRENAJE	BOLT, DISCHARGING OIL	1
26	PAF4-04000036	6EE-E5362-00	TAPÓN COMPLETO	PLUG ASSY	1



REF OEM

REC67D-W0093-00 67D-W0093-00

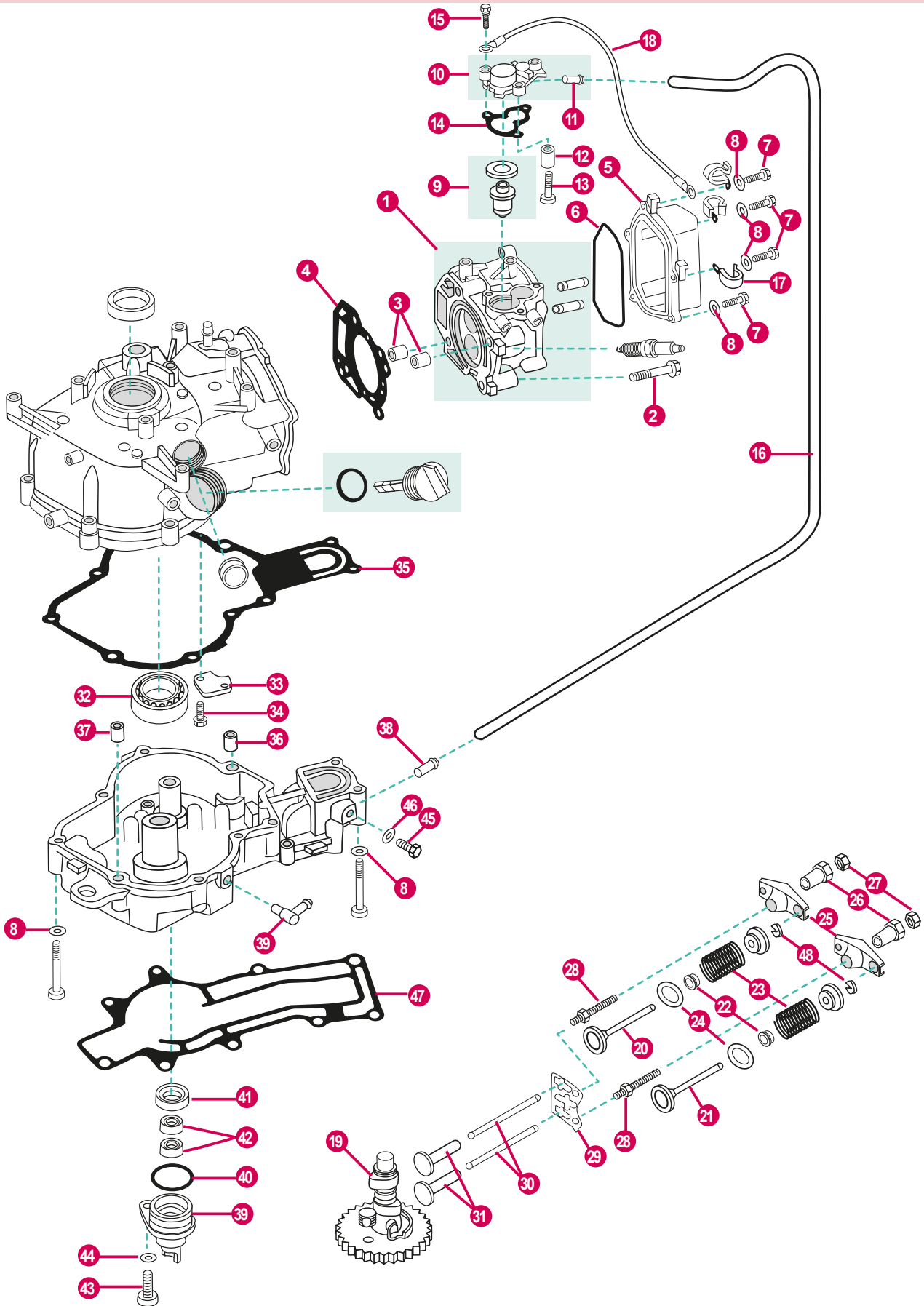

	REF	OEM			UN.
1	PAF6-04050100	6BX-E1111-00-1S	CULATA COMPLETA	CYLINDER HEAD ASSY	1
2	PAF4-04000034	90105-08M36	TORNILLO	SCREW	4
3	PAF4-04000003	99510-10114	PIN CENTRADOR	HOLLOW PIN	2
4	PAF6-04000002	6BX-11181-00	JUNTA CULATA	GASKET, CYLINDER HEAD	1
5	PAF6-04000004	6BX-E1191-00-5B	TAPA CULATA DE CILINDRO	COVER CYLINDER HEAD	1
6	PAF6-04000005	6BX-11356-00	RETÉN DE ACEITE	SEAL RING	1
7	PAGB/T5783-M6X20	97095-06020	TORNILLO	SCREW	5
8	PAGB/T96-6	92995-06600	ARANDELA	WASHER	15
9	PAF15-07000031	66M-12411-01	TERMOSTATO	THERMOSTAT	1
10	PAF4-04070000	68D-E2413-00-1S	TAPA TERMOSTATO	COVER, THERMOSTAT	1
11	PAF4-04010102	650-24378-00	NIPLE	NIPPLE	1
12	PAF4-04070003	68D-E1325-00	ÁNODO	ANODE	1
13	PAGB/T818-M5X25	97880-05025	TORNILLO	SCREW	1
14	PAF4-04000011	68D-E2414-A0	JUNTA TAPA TERMOSTATO	GASKET, THERMOSTAT COVER	1
15	PAGB/T5783-M6X20	90119-06MA2	TORNILLO	SCREW	3
16	PAF6-04000020	6BX-F4323-00	TUBO	TUBE	1
17	PAT36-04000023	90465-06M86	BRIDA	CLAMP	1
18	PAF6-04000009	6G0-82519-00	CABLE MASA	WIRE LEAD	1
19	PAF6-04030000	6BX-E2170-00	ÁRBOL DE LEVAS	CAMSHAFT ASSY	1
20	PAF6-04050001	6BX-12111-00	VÁLVULA ADMISIÓN	VALVE, INTAKE	1
21	PAF6-04050002	6AU-12121-00	VÁLVULA ESCAPE	VALVE, EXHAUST	1
22	PAF166-010003	51Y-12119-00	RETÉN DE ACEITE	SEAL RING	2
23	PAF6-04050003	60R-12113-00	RESORTE DE VÁLVULA	SPRING, VALVE	2
24	PAF4-04080007	68T-12116-00	RETÉN RESORTE	SPRING, VALVE RETAINER	2
25	PA166F-010009	67D-12151-00	BRAZO DE BALANCÍN	ARM, VALVE ROCKER	2
26	PA166F-010010	7FK-12165-00	TUERCA BALANCÍN	PIVOT, ROCKER ARM	2
27	PA166F-010011	7FK-12158-00	TUERCA	LOCK NUT	2
28	PA166F-010008	67D-12157-00	PERNO	BOLT	2
29	PAF6-04050004	6BX-E2155-00	PLETINA EMPUJADORES	PLATE, PUSH ROD	1
30	PAF6-04000003	6BX-12154-00	VARILLA EMPUJADOR	ROD, VALVE PUSH	2
31	PA166F-000001	JA9-12153-00	EMPUJADOR DE VÁLVULA	LIFTER, VALVE PUSH	2
32	PANTN6205C3	93306-205B2	RODAMIENTO	BALL BEARING	1
33	PAF6-04010004	6BX-E1168-00	CUBIERTA DE RESPIRADERO	OIL BAFFLE PLATE	1
34	PAGB/T5783-M5X10	97013-05010	PERNO	BOLT	2
35	PAF6-04000001	6BX-11351-00	JUNTA BASE MOTOR	GASKET ENGINE	1
36	PAF4-04000003	99510-10114	PIN CENTRADOR	HOLLOW PIN	2
37	PAF4-04010102	650-24378-00	PIPA DE AGUA	PIPE, WATER	1
38	PAF15-04000005	676-11372-00	NIPLE DE MANGUERA	WATER NIPPLE	1
39	PAF4-04060001	68D-E5396-00-5B	CAJA DE SELLO DE ACEITE	SHELL, OIL SEAL	1
40	PAGB/T345.2-D32.5XD1	93210-35537	TÓRICA	O-RING	1
41	PAF2.6-04010001	93102-20108	RETÉN DE ACEITE	SEAL RING	1
42	PAF4-04060004	93102-10004	RETÉN DE ACEITE	SEAL RING	2
43	PAGB/T5783-M8X20	97095-08020	PERNO	BOLT	1
44	PAGB/T97.1-8	92995-08600	ARANDELA	WASHER	1
45	PAGB/T5783-M8X14	97095-08014	PERNO	BOLT	1
46	PAF4-04000006	90430-08800	JUNTA	GASKET	1
47	PAF6-00000001	6BX-45113-00	JUNTA	GASKET	1
48	PAF8-05030007	7NJ-12118-00	CLIP	CLIP	1

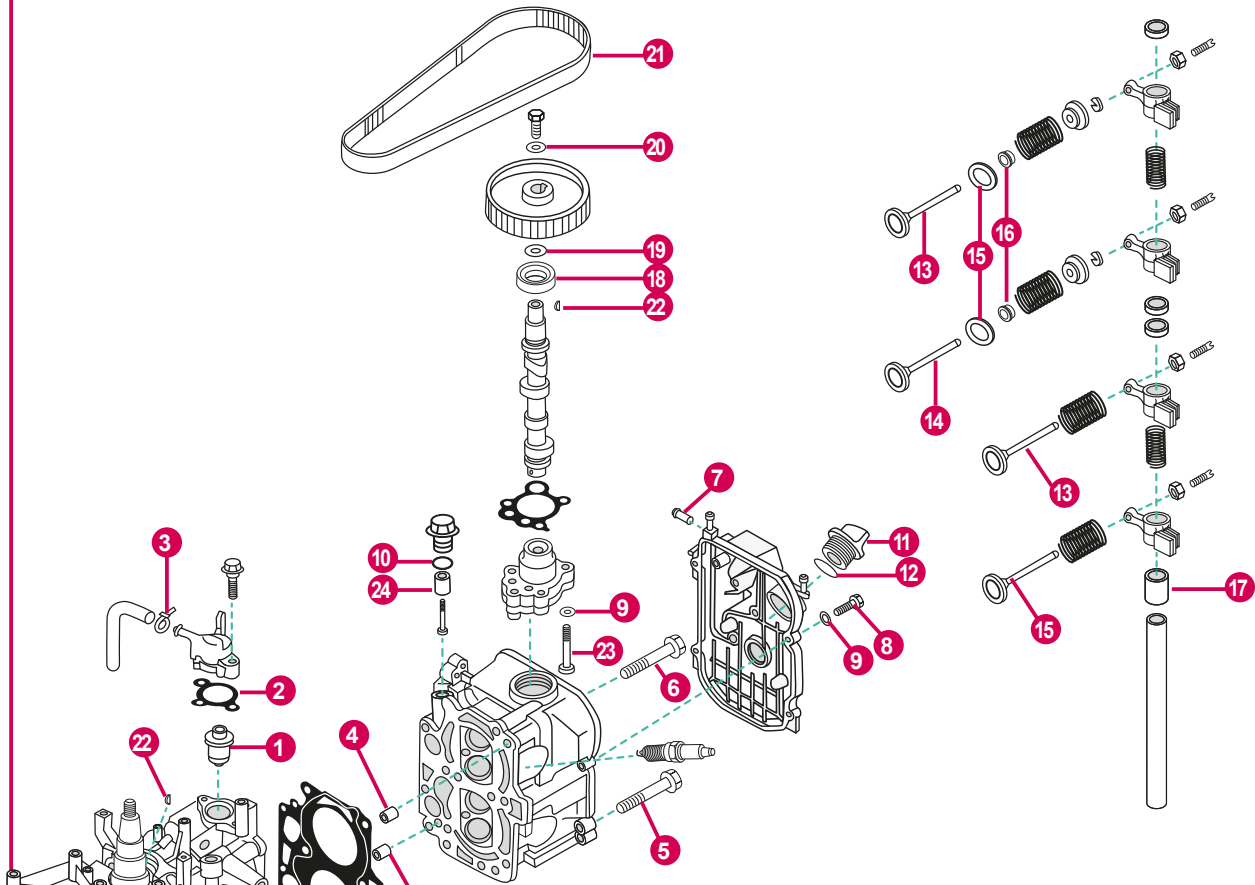

	REF	OEM		UN.	
1	PAF15-07000031	66M-12411-01	TERMOSTATO	THERMOSTAT	1
2	REC6G8-12414-A0	60R-E2414-A0	JUNTA	GASKET	1
3	PAHT-2.5X60	90465-11M10	BRIDA	CLAMP	1
4	PAF15-07000001	99510-10114	PIN CENTRADOR	HOLLOW PIN	2
5	PAF4-04000034	90105-08M36	TORNILLO	SCREW	2
6	PAF15-07000028	90105-08M78	TORNILLO	SCREW	4
7	PAF4-04010102	650-24378-00	PIPA DE AGUA	PIPE, WATER	1
8	PAGB/T5783-M6X20	97095-06020	TORNILLO	BOLT	4
9	PAGB/T96-6	92995-06600	ARANDELA	WASHER	7
10	PAGB/T3452.1-13X2	93210-13M63	TÓRICA	O-RING	1
11	PAF15-07050004	69M-E5363-00	TAPÓN ACEITE	PLUG, OIL	1
12	PAJASOF40435-022	93210-24M79	TÓRICA	O-RING	1
13	PA166F-010001	67D-12111-00	VÁLVULA ADMISIÓN	VALVE, INTAKE	2
14	PAF4-04080006	67D-12121-00	VÁLVULA ESCAPE	VALVE, EXHAUST	2
15	PAF4-04080007	68T-12116-00	ARANDELA DE ASIENTO	SEAT, VALVE SPRING	2
16	PAF166-010003	51Y-12119-00	RETÉN DE ACEITE	SEAL RING	4
17	PAF15-07040012	90387-13M56	CASQUILLO	BUSHER	1
18	PAF15-07040008	93102-18M21	RETÉN DE ACEITE	SEAL RING	1
19	PAF15-07040017	90201-13201	ARANDELA	WASHER	1
20	PAGB/T5287-6	90201-06M94	ARANDELA	WASHER	1
21	REC68T-46241-00	60R-G6241-00	CORREA	BELT	1
22	PAGB/T1099-3X5X13	90280-03M01	CHAVETA	KEY WOODRUFF	2
23	PAGB/T5783-M6X30	97095-06030	PERNO	BOLT	3
24	REC6G8-11325-00AL	6G8-11325-00	ÁNODO	ANODE	1

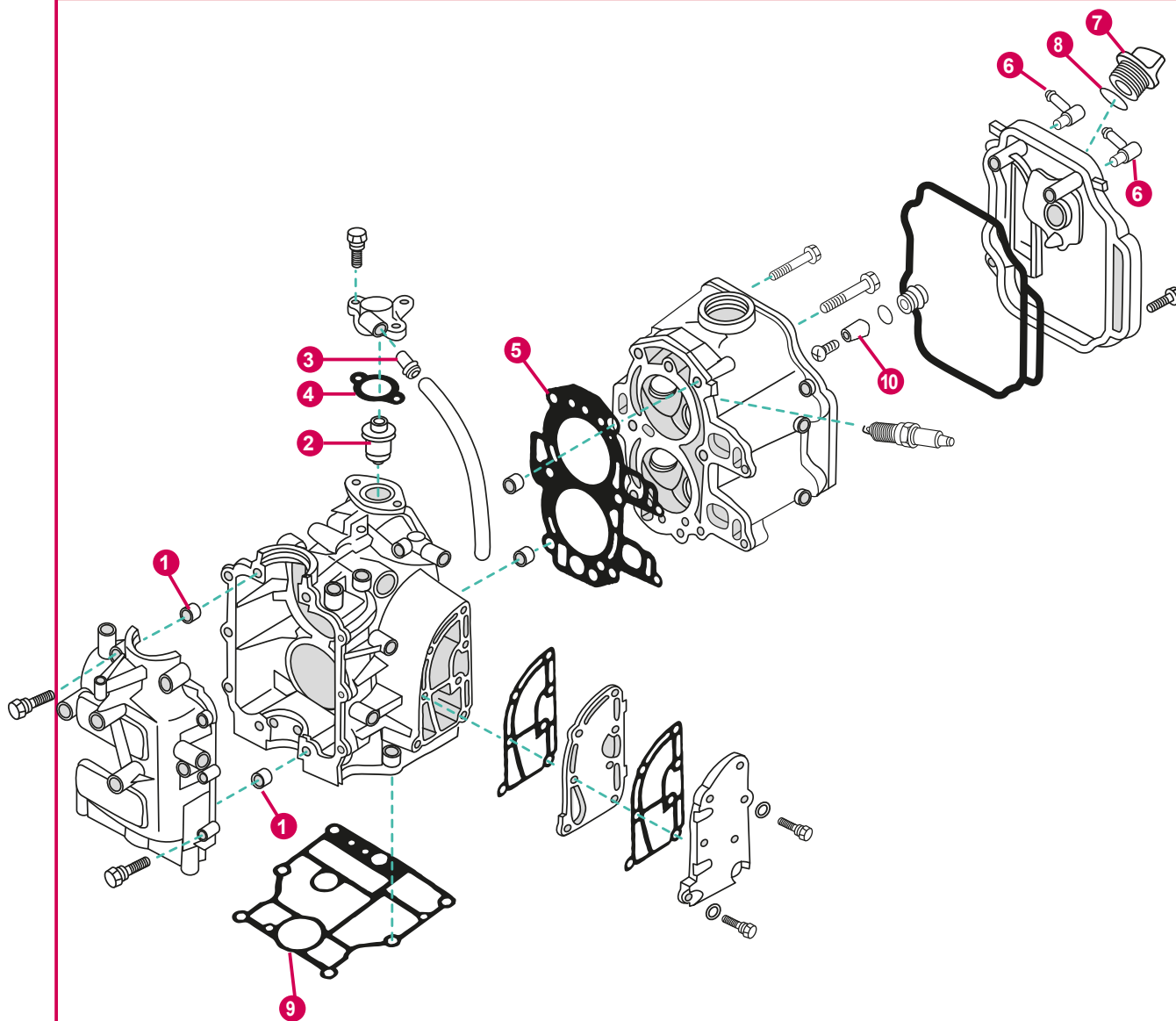

	REF	OEM			UN.
1	PAF15-07000001	91810-03014	PIN	PIN	2
2	REC6AH-12411-00	6G8-12411-00	TERMOSTATO	THERMOSTAT	1
3	PAF15-07010006	6E5-24377-00	PIPA DE AGUA	PIPE, WATER	1
4	REC6G8-12414-A0	6G8-12414-00	JUNTA TAPA TERMOSTATO	GASKET, THERMOSTAT COVER	1
5	REC6G8-11181-A1	6G8-11181-00	JUNTA CULATA	GASKET, CYLINDER HEAD	1
6	PAF15-04000005	676-11372-00	NIPLE	HOSE NIPL	2
7	PAF15-07050004	6G8-15363-00	TAPÓN ACEITE	PLUG, OIL	1
8	PAJASOF40431-025	93210-24M79	TÓRICA	O-RING	1
9	REC6G8-11351-A0	6G8-11351-00	JUNTA BASE MOTOR	GASKET ENGINE	1
10	REC6G8-11325-00AL	6G8-11325-00	ÁNODO	ANODE	1

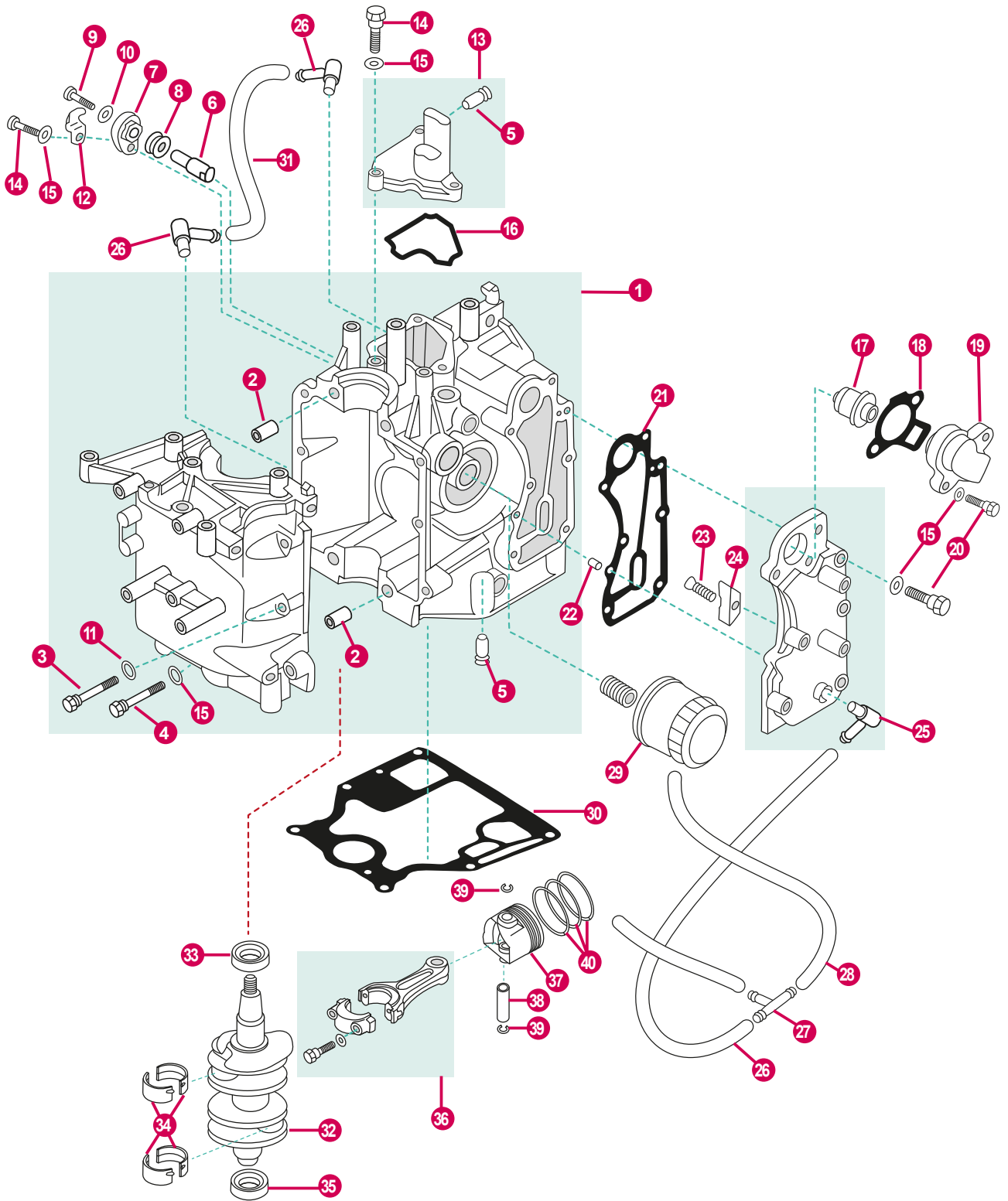

	REF	OEM		UN.	
1	PAF15-07010000	66M-15100-02-1S	BLOQUE MOTOR COMPLETO	CRANKCASE ASSY	1
2	PAF15-07000001	99510-10114	PIN CENTRADOR	HOLLOW PIN	2
3	PAGB/T5783-M5X12	93102-25090	TORNILLO	SCREW	6
4	PAGB/T5783-M5X12	93306-205YD	TORNILLO	SCREW	4
5	PAF15-07010006	6E5-24377-00	PIPA DE AGUA	PIPE, WATER	2
6	PAF15-07010008	66M-11325-00	ÁNODO	ANODE	1
7	PAF15-07010011	66M-11327-00-94	TAPA ÁNODO	COVER, ANODE	1
8	PAF15-07010009	66M-11328-00	ALOJAMIENTO ÁNODO	GROMMET, ANODE	1
9	PAGB/T5783-M5X12	97095-0512	TORNILLO	SCREW	1
10	PAGB/T97.1-8	92995-05600	ARANDELA	WASHER	1
11	PAGB/T97.1-8	97595-06520	ARANDELA	WASHER	4
12	PAF15-07010012	66M-12535-00	EMPAQUETADORA DE ÁNODO	PLATE, ANODE	1
13	PAF15-07010200	66M-11168-001S	TAPA	COVER, BREATHER	1
14	PAGB/T5783-M5X12	97575-08550-00	TORNILLO	SCREW	4
15	PAGB/T97.1-8	93102-20108	ARANDELA	WASHER	17
16	PAF15-07010014	66M-11357-00	JUNTA TAPA	GASKET, COVER	1
17	PAF15-07000031	66M-12411-01	TERMOSTATO	THERMOSTAT	1
18	REC6H3-12414-A1	62Y-12414-00	JUNTA TAPA TERMOSTATO	GASKET, THERMOSTAT COVER	1
19	PAF15-07010021	6H3-12413-001S	TAPA TERMOSTATO	COVER, THERMOSTAT	1
20	PAGB/T5783-M5X12	90201-08818	TORNILLO	SCREW	7
21	PAF15-07010018	66M-41114-01	JUNTA EXTERIR, TAPA DE ESCAPE	GASKET, EXHAUST OUTER COVER	1
22	PAF15-07000013	93604-12M07	PIN	OPIN	2
23	PAGB/T5783-M5X12	68D-E5362-00	TORNILLO	SCREW	1
24	PAF15-07010026	6E5-11325-00	ÁNODO	ANODE	1
25	PAF15-04000005	676-11372-00	NIPLE DE MANGUERA	NIPPLE	3
26	PAF15-05000012	90445-09061	TUBO	HOSE A	1
27	PAF15-05000011	688-24378-00	CONECTOR DE 3 VÍAS	THREE-WAY PIPE	1
28	PAF15-05000014	90445-09104	TUBO	HOSE C	1
29	PAF15-07010023	5GH-13440-00	FILTRO ACEITE	OIL FILTER	1
	REC5GH-13440-00	5GH-13440-00	FILTRO ACEITE	OIL FILTER	1
30	PAF15-00000014	66M-11351-10	JUNTA BASE MOTOR	GASKET ENGINE	1
31	PAF15-07010007	90445-10M46	TUBO	HOSE, RETURN OIL	1
32	PAF15-07030000	66M-11411-00	CIGÜEÑAL	CRANK ASSY	1
33	PAF15-07030006	93102-35M51	RETÉN DE ACEITE	OIL SEAL	1
34	PAF15-07010024	66M-11416-00	COJINETE BANCADA	MAIN BEARING	4
35	PAF15-07030007	93102-25M52	RETÉN DE ACEITE	OIL SEAL	1
36	PAF15-07020100	66M-11650-00	BIELA	ROD, CONNECTING	2
37	PAF15-07020001	66M-11631-00-96	PISTÓN	PISTON	2
38	PAF15-07020006	634-11633-00	BULÓN	PIN, PISTON	2
39	PAF15-07020005	93450-15023	CIRCLIP	CIRCLIP	4
40	REC66N-11603-00	66N-11603-00	KIT SEGMENTOS DE PISTÓN	PISTON RING KIT	2



REF	OEM
REC66M-W0093-01	66M-W0093-01

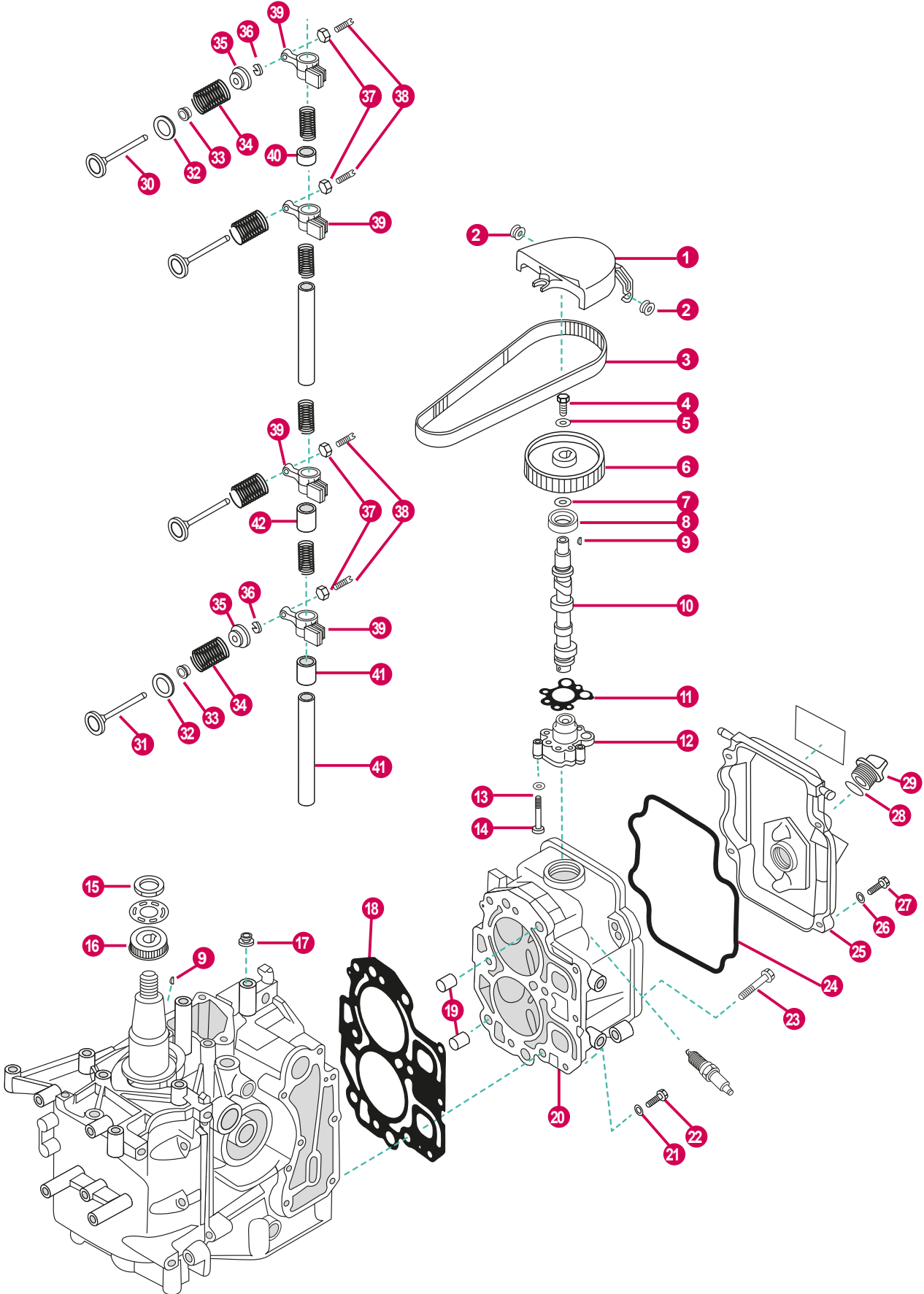

	REF	OEM			UN.
1	PAF15-07000024	66M-46297-00	TAPA	COVER, DUST	1
2	PAF15-07050003	90480-10M16	GOMA	RING RUBBER A	2
3	REC66M-46241-00	66M-46241-00	CORREA DISTRIBUCIÓN	BELT TIMING	1
4	PAGB/T5783-M5X12	97013-06016	TORNILLO	BOLT	1
5	PAGB/T5287-6	90201-06M94	ARANDELA	BIG WASHER	1
6	PAF15-07040018	66M-11537-00-94	POLEA DE CORREA	BELT PULLEY, DRIVEN	1
7	PAF15-07040017	90201-13201	ARANDELA	WASHER	1
8	PAF15-07040008	93102-18M21	RETÉN DE ACEITE	OIL SEAL	1
9	PAGB/T1099-3X5X13	90280-03M01	CHAVETA	KEY, WOODRUFF	2
10	PAF15-07040200	66M-12170-00	ÁRBOL DE LEVAS	CAMSHAFT ASSY	1
11	PAF15-07040016	66M-13329-10	JUNTA	MAT, AIRPROOF	1
12	PAF15-07040500	66M-13300-10	BOMBA ACEITE	OIL PUMP ASSY	1
13	PAGB/T97.1-8	92995-06600	ARANDELA	WASHER	3
14	PAGB/T5783-M5X12	97095-06035	TORNILLO	BOLT	3
15	PAF15-07030005	90170-28M37	TUERCA	NUT	1
16	PAF15-07030003	66M-11536-10	POLEA DENTADA	BELT PULLEY, TIMING	1
17	PAF15-07010027	90480-12072	GOMA	RUBBER RING	1
18	PAF15-07000100	66M-11181-10	JUNTA CULATA	GASKET, CYLINDER HEAD	1
19	PAF15-07000001	99510-10114	PIN CENTRADOR	HOLLOW PIN	2
20	PAF15-07040000	66M-11111-01-1S	CULATA	CYLINDER HEAD ASSY	1
21	PAGB/T96-6	92990-06600	ARANDELA	WASHER	3
22	PAGB/T5783-M6X25	97513-06525	TORNILLO	BOLT	3
23	PAF15-07000028	90105-08M78	TORNILLO	BOLT, FLANGE	6
24	PAF15-07050002	66M-11356-00	JUNTA TAPA	SEAL, CYLINDER COVER	1
25	PAF15-07050001	66M-11191-00-1S	TAPA BALANCINES	COVER, CYLINDER HEAD	1
26	PAGB/T5783-M5X12	92995-06600	ARANDELA	WASHER, PLATE	7
27	PAGB/T5783-M6X20	97595-06520	TORNILLO	BOLT	4
28	PAJASOF40435-022	93210-24M79	TÓRICA	O-RING	1
29	PAF15-07050004	6G8-15363-00	TAPÓN ACEITE	PLUG, OIL	1
30	PAF15-07040001	66M-12111-00	VÁLVULA ADMISIÓN	VALVE, INTAKE	2
31	PAF15-07040002	66M-12121-00	VÁLVULA ESCAPE	VALVE, EXHAUST	2
32	PAF15-07040004	66M-12116-00	ARANDELA DE ASIENTO	SEAT, VALVE SPRING	4
33	PAF166-010003	51Y-12119-00	RETÉN	SEAL, VALVESTEM	4
34	PAF15-07040005	66M-12113-00	MUELLE	SPRING, VALVE	4
35	PAF15-07050006	30X-12117-00	RETÉN RESORTE	SPRING, VALVE RETAINER	4
36	PAF15-07040007	30X-12118-00	SEGURO DE VÁLVULA	CLAMP, VALVE	8
37	PAF15-07040304	62Y-12158-00	TUERCA	LOCK NUT	4
38	PAF15-07040303	62Y-12159-00	TORNILLO REGULADOR	SCREW, VALVE ADJUSTING	4
39	PAF15-07040301	66M-12151-10	BALANCÍN	VALVE ROCKER	4
40	PAF15-07040009	90387-13001	CASQUILLO	BUSHER	1
41	PAF15-07040012	90387-13M56	CASQUILLO B	BUSHER B	1
42	PAF15-07040011	90387-13002	CASQUILLO A	BUSHER A	1

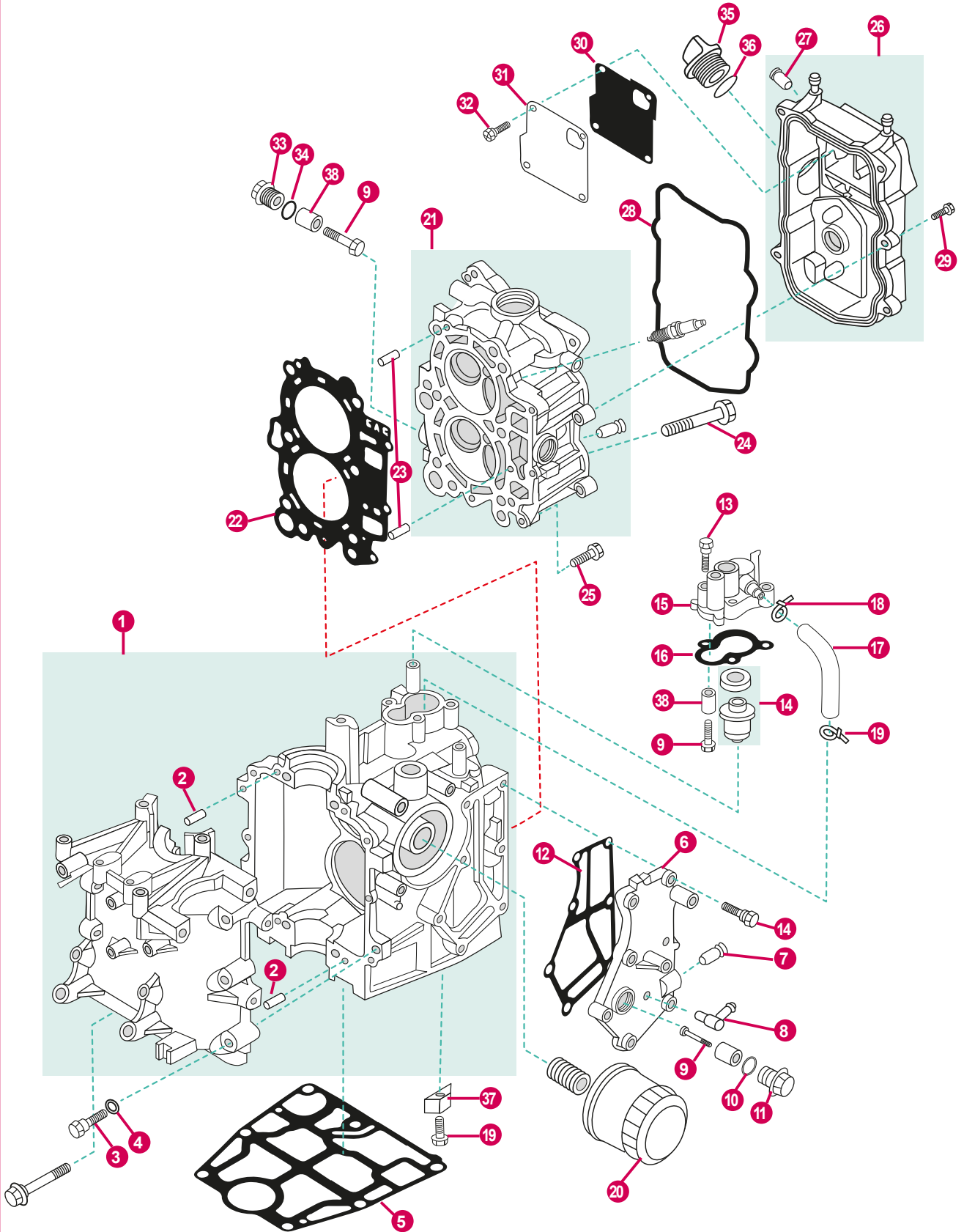

	REF	OEM			UN.
1	PAF20-05010000	6AH-15100-00	CÁRTER COMPLETO	CRANKCASE ASSY	1
2	REC93606-12019	93606-12019	PIN CENTRADOR	HOLLOW PIN	4
3	PAF20-05010007	97013-06040	PERNO	BOLT	6
4	PAGB/T96-6	92903-06600	ARANDELA	WASHER	6
5	REC6AH-11351-00	6AH-11351-10	JUNTA DE ESCAPE	EXHAUST GASKET	1
6	PAF20-05000600	6AH-41113-01-1S	CUBIERTA DE ESCAPE	EXHAUST COVER	1
7	PAF4-04010102	6E9-24378-00	PIPA DE AGUA	PIPE, WATER	1
8	PAF15-04000005	6H1-11372-00	NIPLE DE MANGUERA	NIPPLE	1
9	PAGB/T818-M5X25	98980-05025	TORNILLO	SCREW	4
10	PAGB/T3452.1-13X2	93210-13M63	ANILLO	O-RING	1
11	PAF20-05030009	6G8-11197-A0	TAPÓN	CAP	1
12	PAF20-05000602	6AH-41114-00	JUNTA DE ESCAPE	EXHAUST GASKET	1
13	PAGB/T5783-M6X25	90119-06MA3	TORNILLO	SCREW	3
14	REC6AH-12411-00	6AH-12411-00	TERMOSTATO	THERMOSTAT	1
15	PAF20-05000700	6AH-12413-00-1S	TAPA TERMOSTATO	COVER, THERMOSTAT	1
16	PAF20-05000702	6AH-12414-00	JUNTA	GASKET	1
17	PAF20-05000016	6AH-12481-00	TUBO DE AGUA	WATER TUBE	1
18	PAHT2.5X50	90465-11M10	BRIDA	CLAMP	2
19	PAGB/T820-M4X12	98780-04016	TORNILLO	SCREW	1
20	REC5GH-13440-60	5GH-13440-60	FILTRO ACEITE	OIL FILTER	1
21	PAF20-05030100	6AH-11111-10-1S	CULATA	CYLINDER HEAD	1
22	REC6AG-11181-00	6AG-11181-10	JUNTA CULATA	GASKET, CYLINDER HEAD	1
23	REC93606-12019	93606-12019	PIN CENTRADOR	HOLLOW PIN	2
24	PAF20-05000002	90105-090006	TORNILLO	SCREW	6
25	PAF8-05000022	90119-06MA3	TORNILLO	SCREW	3
26	PAF20-05040000	6AH-11191-001S	TAPA DE CULATA COMPLETA	CYLINDER HEAD COVER ASSY	1
27	PAF20-05040005	6AH-11372-00	NIPLE DE MANGUERA	NIPPLE	1
28	PAF20-05040002	6AH-11356-00	RETÉN DE ACEITE	OIL SEAL	1
29	PAGB/T5783-M6X20	97595-06520	PERNO	STUD	5
30	PAF20-05040003	6AH-11168-00	CUBIERTA DE RESPIRADERO	COVER, BREATHER	1
31	PAF20-05040004	6AH-11169-00	JUNTA DE CUBIERTA	GASKET, BREATHER	1
32	PAGB/T818-M4X10	97607-04210	TORNILLO	SCREW	4
33	PAF20-05030009	6G8-11197-A0	TAPÓN	CAP	2
34	PAGB/T3452.1-13X2	93210-13M63	ANILLO	O-RING	2
35	PAF15-07050004	6G8-15363-00	TAPÓN DE ACEITE	OIL CAP	1
36	PAJASOF40431-025	93210-24M79	ANILLO	O-RING	1
37	REC6E5-11325-00AL	6E5-11325-00	ÁNODO	ANODE	1
38	REC6G8-11325-00AL	6G8-11325-00	ÁNODO	ANODE	2

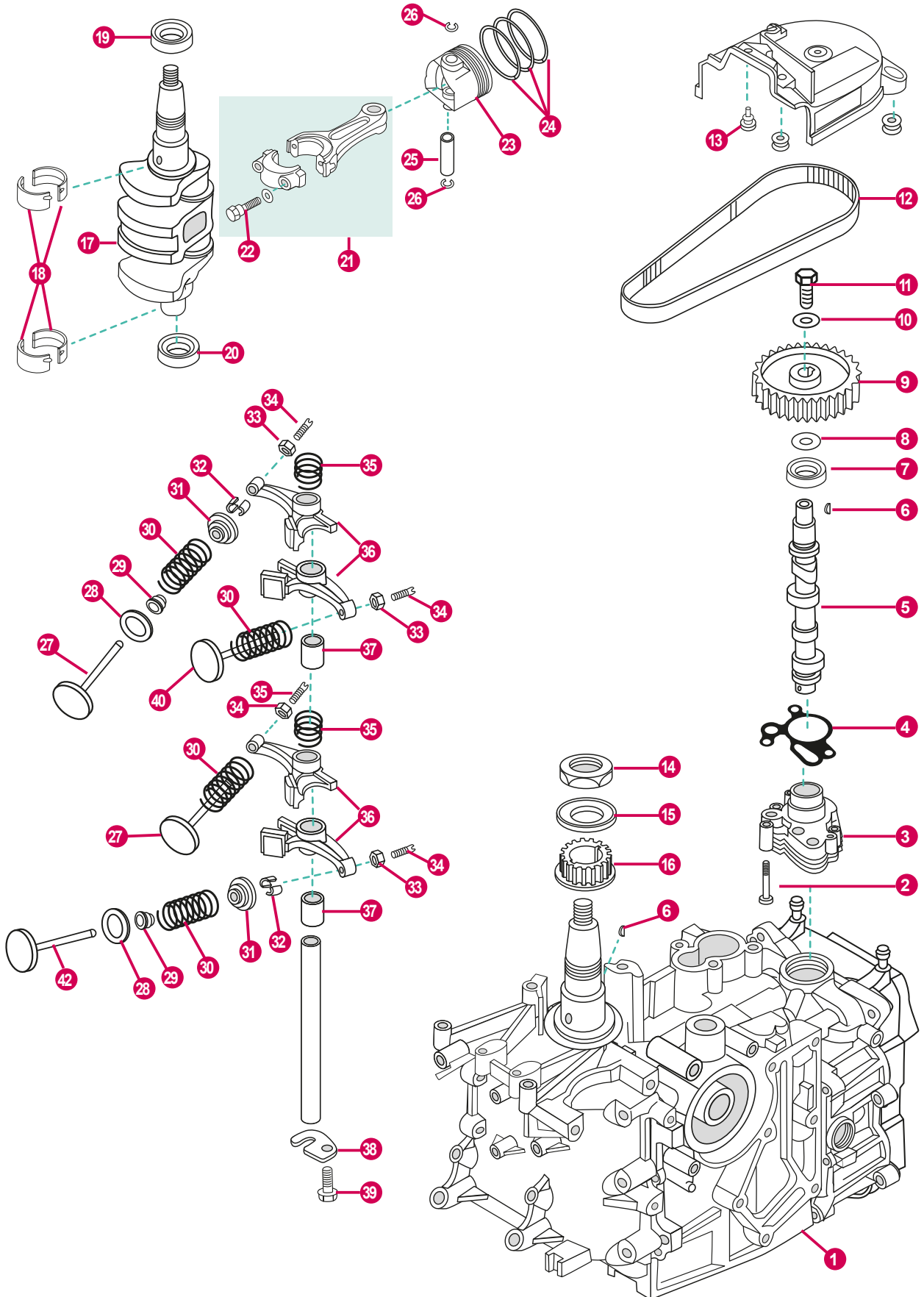

	REF	OEM			UN.
1	PAF20-0500000	6AH-W009B-02-1S	CILINDRO BLOQUE COMPLETO	POWER HEAD ASSY	1
2	PAGB/T5783-M6X35	90105-06035	TORNILLO	SCREW	3
3	PAF20-05030400	6AH-13300-00	BOMBA DE ACEITE	OIL PUMP	1
4	PAF20-05030010	6AH-13329-10	JUNTA TAPA	GASKET, COVER	1
5	PAF20-05030200	6AH-12170-00	ÁRBOL DE LEVAS	CAMSHAFT ASSY	1
6	PAGB/T1099-3X5X13	90280-03M01	CUÑA	KEY WOODRUFF	2
7	PAF20-05030005	93102-22010	RETÉN DE ACEITE	OIL SEAL	1
8	PAF20-05030011	90201-15423	ARANDELA	WASHER	1
9	PAF20-05030012	6AH-11537-00	POLEA DE CORREA	BELT PULLEY, DRIVEN	1
10	PAF20-05030013	90201-08784	ARANDELA	WASHER	1
11	PAGB/T5783-M8X25	90105-081A7	TORNILLO	SCREW	1
12	PAF20-05000003	6AH-46241-00	CORREA	BELT	1
13	PAF20-05000036	90480-06M19	TAPÓN	CAP	1
14	PAF20-05000029	90170-30003	TUERCA	NUT	1
15	PAF20-05000028	6AH-11557-00	ARANDELA	WASHER	1
16	PAF20-05000027	6AH-11536-00	ENGRANAJE DE DISTRIBUCIÓN	BELT PULLEY, TIMING	1
17	PAF20-05020004	6AH-11411-00	CIGÜEÑAL	CRANK ASSY	1
18	PAF20-05010003	6AH-11416-00	COJINETE BANCADA	MAIN BEARING	1
19	PAF25-05050021	93102-37004	RETÉN DE ACEITE	OIL SEAL	1
20	PAF15-07030006	93102-25014	RETÉN DE ACEITE	OIL SEAL	1
21	PAF20-05020200	6AH-11650-10	BIELA	ROD, CONNECTING	2
22	PAF25-05020204	6AH-11654-00	TORNILLO	SCREW	2
23	PAF20-05020001	6AH-11631-00	PISTÓN STD	PISTON STD	2
24	PAF20-05020100	6AH-11603-00	KIT SEGMENTOS DE PISTÓN STD	PISTON RING KIT STD	2
25	PAF20-05020003	137-11633-10	PIN, PISTÓN	PIN, PISTON	2
26	PAF20-05020002	93450-17129	CIRCLIP	CIRCLIP	4
27	PAF20-05030001	6AH-12111-00	VÁLVULA ADMISIÓN	VALVE, INTAKE	2
28	PAF20-05030003	62Y-12116-00	ARANDELA DE ASIENTO	SEAT, VALVE SPRING	4
29	PAF166-010003	51Y-12119-00	RETÉN DE ACEITE	OIL SEAL	4
30	PAF20-05030004	3YF-12113-00	MUELLE DE VÁLVULA	SPRING, VALVE STEM	4
31	PAF15-07040006	30X-12117-00	RETÉN RESORTE	SPRING, VALVE RETAINER	4
32	PAF15-07040007	30X-12118-00	SEGURO DE VÁLVULA	CLAMP, VALVE	8
33	PAF15-07040304	62Y-12158-00	TUERCA	LOCK NUT	4
34	PAF15-07040303	64J-12159-00	TORNILLO REGULADOR	SCREW, VALVE ADJUSTING	4
35	PAF20-05030007	90501-120A5	RESORTE DE COMPRESIÓN	SPRING, ROCKER	2
36	PAF20-05030301	6AH-12151-00	BRAZO DE BALANCÍN	ARM, VALVE ROCKER	4
37	PAF20-05030006	90387-13006	ESPACIADOR	COLLAR	2
38	PAF20-05030008	6AH-12279-00	PLACA	PLATE	1
39	PAGB/T5783-M6X12	97013-06012	TORNILLO	SCREW	1
40	PAF20-05030002	6AH-12121-10	VÁLVULA ESCAPE	VALVE, EXHAUST	2

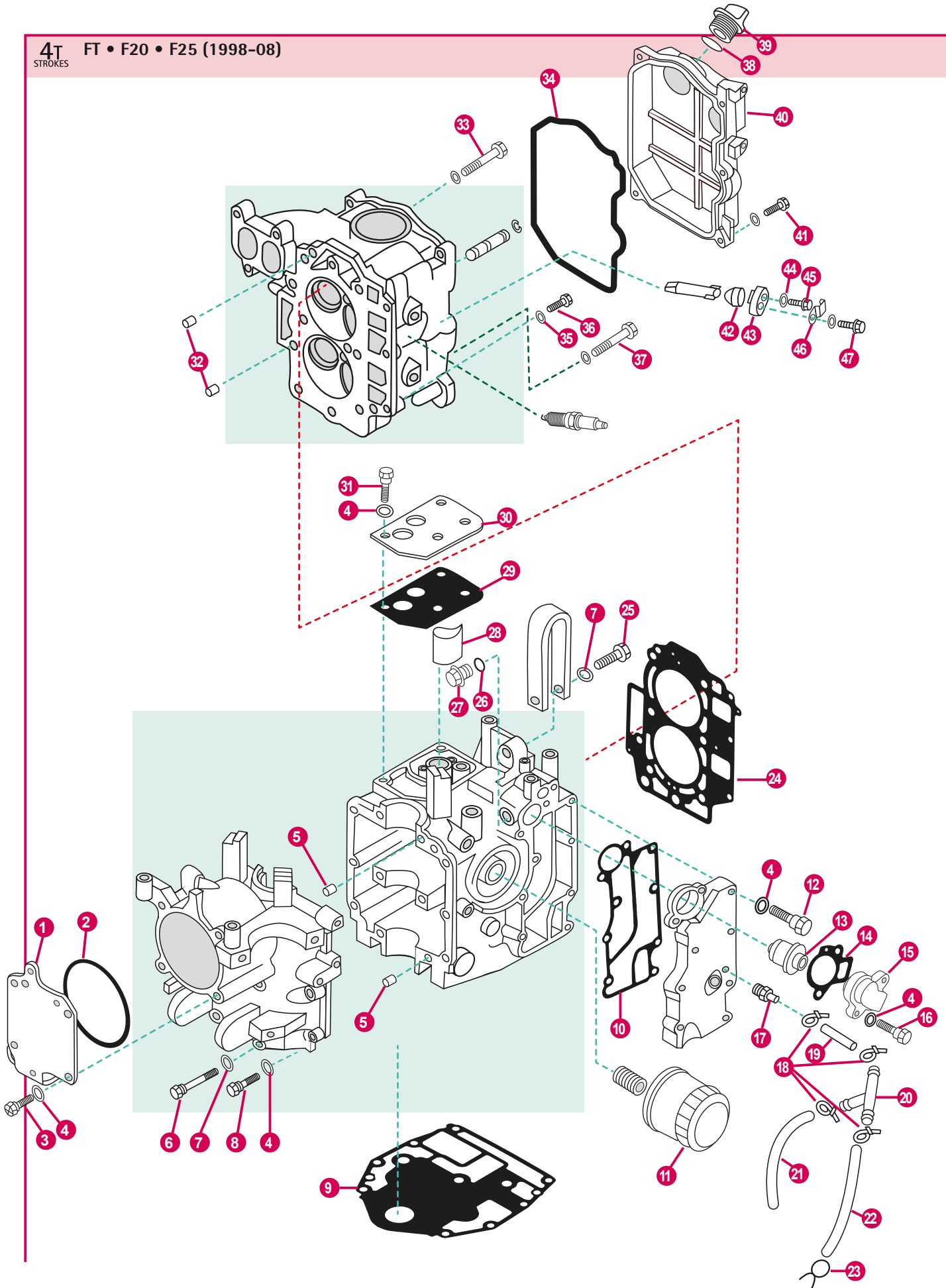

	REF	OEM			UN.
1	PAF25-05000007	65W-15121-00	TAPA	COVER	1
2	PAGBT3452.1-97.5X1.8	65W-15663-00	JUNTA	SEAL	1
3	PAGB/T5783-M6X20	65W-12228-00	TORNILLO	BOLT, HEXAGON	4
4	PAGB/T97.1-8	66M-11356-00	ARANDELA	WASHER 6	17
5	PAF25-00000014	99530-08012	PIN CENTRADOR	HOLLOW PIN	2
6	PAGB/T5782-M8X80	90119-08M01	TORNILLO	BOLT, HEXAGON	6
7	PAGB/T97.1-8	97595-06520	ARANDELA	WASHER	7
8	PAGB/T5782-M6X35	90119-06MA5	TORNILLO	BOLT, HEXAGON	6
9	REC65W-11351-10	65W-11351-00	JUNTA BASE MOTOR	GASKET ENGINE	1
10	PAF25-05010111	65W-41114-00	JUNTA EXTERIOR, TAPA DE ESCAPE	GASKET, EXHAUST OUTER COVER	1
11	PAF25-05000100	5GH-13440-00	FILTRO ACEITE	OIL FILTER	1
	REC5GH-13440-00	5GH-13440-00	FILTRO ACEITE	OIL FILTER	1
12	PAGB/T5783-M6X35	90119-06MAS	TORNILLO	BOLT	7
13	PAF15-07000031	6G8-12411-02	TERMOSTATO	THERMOSTAT	1
14	REC6H3-12414-A1	62Y-12414-00	JUNTA TAPA TERMOSTATO	GASKET, THERMOSTAT COVER	1
15	PAF15-07010021	6H3-12413-00-9M	TAPA TERMOSTATO	COVER, THERMOSTAT	1
16	PAGB/T5783-M6X25	90119-06MA5	TORNILLO	BOLT	2
17	PAF25-05010113	62Y-11372-01	NIPLA DE MANGUERA	NIPPLE	1
18	PAHT-2.5x60	90465-11M10	BRIDA	CLAMP	5
19	PAF25-03000008	90445-09068	TUBO DE AGUA	WATER TUBE	1
20	PAF15-05000011	688-24378-00	CONECTOR DE 3 VÍAS	THREE-WAY PIPE	1
21	PAF25-03000009	90445-09095	TUBO DE AGUA	WATER TUBE	1
22	PAF25-03000011	90445-09105	TUBO DE AGUA	WATER TUBE	1
23	PAF4-04000030	90467-09M09	MUELLE TUBO COMBUSTIBLE B	SPRING, FUEL PIPE B	1
24	PAF25-05040000	65W-11181-30	JUNTA CULATA	GASKET, CYLINDER HEAD	1
25	PAGB/T5782-M8X35	65W-08M87	TORNILLO	BOLT, HEXAGON	1
26	PAF15-04000003	90430-14M09	ARANDELA	WASHER	1
27	PAF15-04000002	90340-14M06	TORNILLO DRENAJE	BOLT, DISCHARGING OIL	1
28	PAF25-05010107	65W-13286-00	FILTRO ACEITE	OIL FILTER	1
29	PAF25-05010108	65W-11169-00	JUNTA DE CUBIERTA	GASKET, BREATHER	1
30	PAF25-05010103	65W-11168-00	CUBIERTA DE RESPIRADERO	COVER, BREATHER	1
31	PAGB/T5783-M6X20	65W-12228-00	TORNILLO	BOLT, HEXAGON	4
32	PAF25-00000014	99530-08012	PIN CENTRADOR	HOLLOW PIN	2
33	PAF25-05050006	90109-06M65	TORNILLO	BOLT	1
34	PAF25-05000004	65W-11356-00	JUNTA TAPA	GASKET, COVER	1
35	PAGB/T97.1-8	97595-06520	ARANDELA	WASHER, PLATE	10
36	PAGB/T5783-M6X25	90119-06MA3	TORNILLO	BOLT, HEXAGON	6
37	PAF25-05000002	90119-09M00	TORNILLO	BOLT, FLANGE	9
38	PAJASOF40431-025	93210-24M79	TÓRICA	O-RING	1
39	PAF15-07050004	6G8-15363-00	TAPÓN ACEITE	PLUG, OIL	1
40	PAF25-05000005	65W-11191-00-94	TAPA BALANCINES	COVER, CYLINDER HEAD	1
41	PAGB/T5783-M6X20	90119-06MA3	TORNILLO	BOLT, HEXAGON	5
42	PAF15-07010009	66M-11328-00	ALOJAMIENTO ÁNODO	GROMMET, ANODE	2
43	PAF15-07010011	66M-11327-00-94	TAPA	COVER, ANODE	2
44	PAGB/T97.1-5	92995-05600	ARANDELA	WASHER, PLATE	2
45	PAGB/T5783-M5X12	97095-05012	TORNILLO	BOLT, HEXAGON	2
46	PAF15-07010012	66M-12535-00	PLETINA	PLATE, ANODE	2
47	PAGB/T5783-M6X20	97095-06020	TORNILLO	BOLT, HEXAGON	2

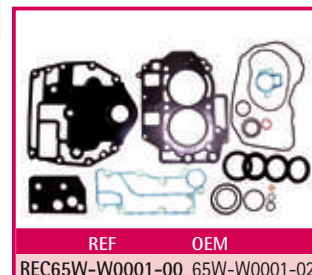

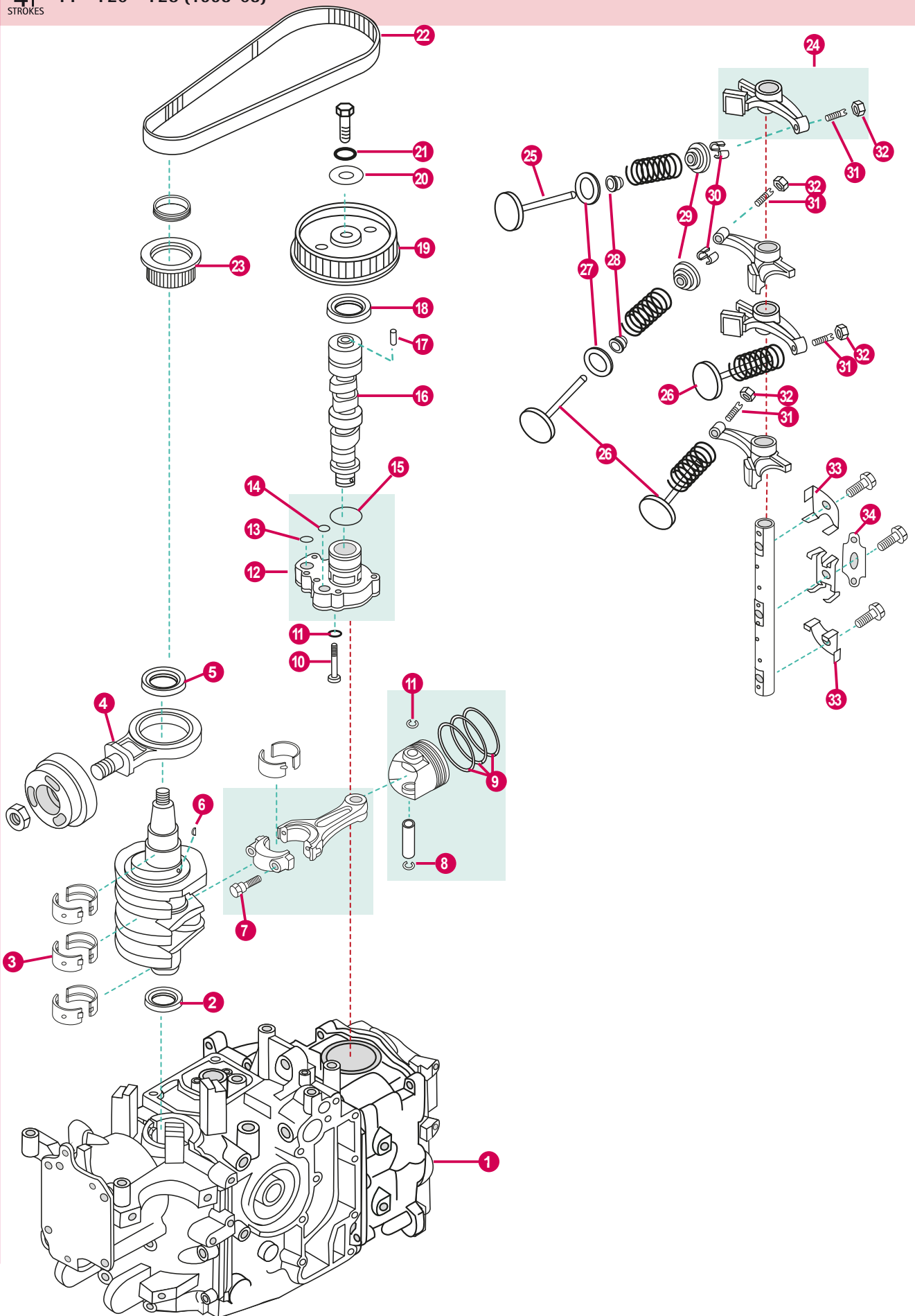

	REF	OEM			UN.
1	POWERHEAD20-25		MOTOR	COMPLETE, POWER	1
2	PAF25-05020002	93102-35M47	RETÉN	OIL-SEAL	1
3	PAF25-05010302-2	62Y-11416-10	COJINETE BANCADA BLACK	MAIN BEARING BLACK	6
4	PAF25-05020310	65W-11665-00	BIELA, CONTRO	CON-ROD ASSY, BALANCE	1
5	PAF25-05020003	93102-43M42	RETÉN	OIL SEAL	1
6	PAF4-04000019	90280-04M06	CUÑA	KEY WOODRUFF	1
7	PAF25-05020204	62Y-11654-00	TORNILLO	BOLT, CONNECTING ROD	2
8	PAF25-05020106	93450-17129	CLIP	CIRCLIP	4
9	REC67C-11603-00	67C-11603-00	KIT SEGMENTOS DE PISTÓN	PISTON RING KIT	2
10	PAGB/T5782-M6X125	97013-06035	TORNILLO	BOLT	4
11	PAGB/T97.1-8	66M-11328-00	ARANDELA	WASHER , PLATE	4
12	PAF25-05050400	65W-13300-00	BOMBA ACEITE COMPLETA	OIL PUMP ASSY	1
13	PAF25-05050014	93210-14515	TÓRICA B	O-RING B	1
14	PAF25-05050013	93210-12MG9	TÓRICA A	O-RING A	1
15	PAF25-05050015	93210-33MH2	TÓRICA C	O-RING C	1
16	PAF25-05050200	65W-12171-10	ÁRBOL DE LEVAS	CAMSHAFT ASSY	1
17	PAF25-05050016	93605-14143	PIN CENTRADOR	HOLLOW PIN	1
18	PAF25-05050021	93102-37M40	RETÉN	OIL SEAL	1
19	PAF25-05050017	65W-11537-01	POLEA DE CORREA	BELT PULLEY, DRIVEN	1
20	PAF25-05050018	90201-10M06	ARANDELA	WASHER, PLATE	1
21	PAGB/T97.1-8	97595-06520	ARANDELA	WASHER, PLATE	1
22	REC65W-46241-00	65W-46241-00	CORREA DISTRIBUCIÓN	BELT, TIMING	1
23	PAF25-05000021	65W-11536-10	ENGRANAJE DE DISTRIBUCIÓN	BELT PULLEY, TIMING	1
24	PAF25-05050300	65W-12151-00	BALANCÍN COMPLETO	ROCKET ASSY	4
25	PAF25-05050002	62Y-12121-00	VÁLVULA ESCAPE	VALVE, EXHAUST	2
26	PAF25-05050001	67C-12111-00	VÁLVULA ADMISIÓN	VALVE, INTAKE	2
27	PAF25-05050003	62Y-12116-00	ARANDELA ASIENTO	SEAT, VALVE SPRING	4
28	PAF166-010003	51Y-12119-00	RETÉN DE ACEITE	OIL SEAL	4
29	PAF15-07040006	30X-12117-00	RETÉN RESORTE	SPRING, VALVE RETAINER	4
30	PAF15-07040007	30X-12118-00	SEGURO DE VÁLVULA	CLAMP, VALVE	8
31	PAF15-07040303	62Y-12159-00	TORNILLO REGULADOR	SCREW, VALVE ADJUSTING	4
32	PAF15-07040304	62Y-12158-00	TUERCA	NUT	4
33	PAF25-05050009	62Y-12238-00	PLETINA	PLATE, BOLT STOPPER	2
34	PAF25-05050012	62Y-12231-00	PLETINA	PLATE B, BOLT STOPPER	1

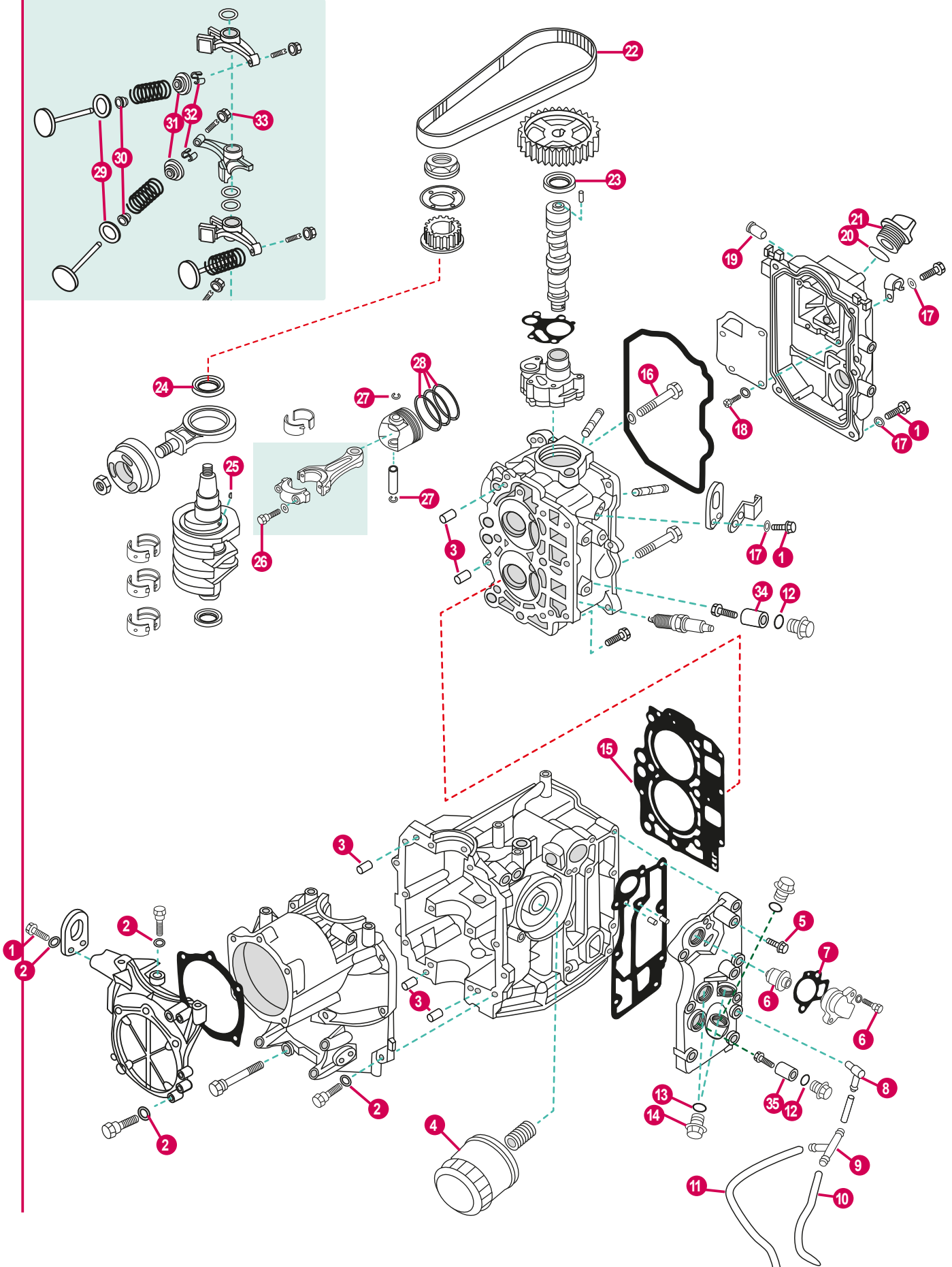

	REF	OEM			UN.
1	PAGB/T5783-M6X20	97095-06020	TORNILLO	SCREW	9
2	PAGB/T96-6	92995-06600	ARANDELA	WASHER	16
3	REC93606-12019	93606-12019	PIN CENTRADOR	HOLLOW PIN	5
4	REC5GH-13440-60	5GH-13440-20	FILTRO ACEITE	OIL FILTER	1
5	PAGB/T5783-M6X30	90119-06MA5	TORNILLO	SCREW	8
6	PAF15-07000031	6G8-12411-03	TERMOSTATO	THERMOSTAT	1
7	REC6H3-12414-A1	62Y-12414-00	JUNTA TAPA TERMOSTATO	GASKET, THERMOSTAT COVER	1
8	PAF15-04000005	676-11372-00	NIPLA DE MANGUERA	NIPPLE	1
9	PAF15-05000011	688-24378-00	CONECTOR DE 3 VÍAS	THREE-WAY PIPE	1
10	PAF25-03000011	90445-09251	TUBO DE AGUA	WATER TUBE	1
11	PAF25-03000009	90445-09104	TUBO DE AGUA	WATER TUBE	1
12	PAGB/T3452.1-13X2	93210-13M63	TÓRICA	O-RING	1
13	PAF15-04000003	90430-14115	TÓRICA	O-RING	2
14	PAF15-04000002	90340-14M06	TORNILLO DRENAJE	BOLT, DISCHARGING OIL	2
15	REC6BL-11181-00	6BL-11181-00	JUNTA CULATA	GASKET, CYLINDER HEAD	1
16	PAF25-05050006	90109-06M65	PERNO	STUD	1
17	PAGB/T96-6	92995-06600	ARANDELA	WASHER	8
18	PAGB/T818-M4X10	98507-04010	TORNILLO	SCREW	4
19	PAF20-05040005	62Y-14485-00	PIPA DE AGUA	PIPE, WATER	1
20	PAJASOF40431-025	93210-24M79	TÓRICA	O-RING	1
21	PAF15-07050004	6G8-15363-00	TAPÓN ACEITE	PLUG, OIL	1
22	REC6C5-46241-00	6C5-46241-00	CORREA DISTRIBUCIÓN	BELT, TIMING	1
23	PAF25-05050021	93102-37M40	RETÉN DE ACEITE	OIL SEAL	1
24	PAF25-05020003	93102-43M42	RETÉN DE ACEITE	OIL SEAL	1
25	PAGB/T1099-3X5X13	90280-03M01	CUÑA	KEY WOODRUFF	1
26	PAF25-05020204	6C5-11654-00	TORNILLO	SCREW	2
27	PAF25-05020106	93450-17129	CIRCLIP	CIRCLIP	4
28	REC67C-11603-00	67C-11603-00	KIT SEGMENTOS DE PISTÓN	PISTON RING KIT	2
29	PAF25-05050003	62Y-12116-00	ARANDELA ASIENTO	SEAT, VALVE SPRING	4
30	PAF166-010003	51Y-12119-00	RETÉN DE ACEITE	OIL SEAL	4
31	PAF15-07040006	30X-12117-00	RETÉN RESORTE	SPRING, VALVE RETAINER	4
32	PAF15-07040007	30X-12118-00	SEGURO DE VÁLVULA	CLAMP, VALVE	8
33	PAF15-07040304	62Y-12158-00	TUERCA	NUT	1
34	REC6BL-11325-00AL	6BL-11325-00	ÁNODO	ANODE	1
35	REC6G8-11325-00AL	6G8-11325-00	ÁNODO	ANODE	2

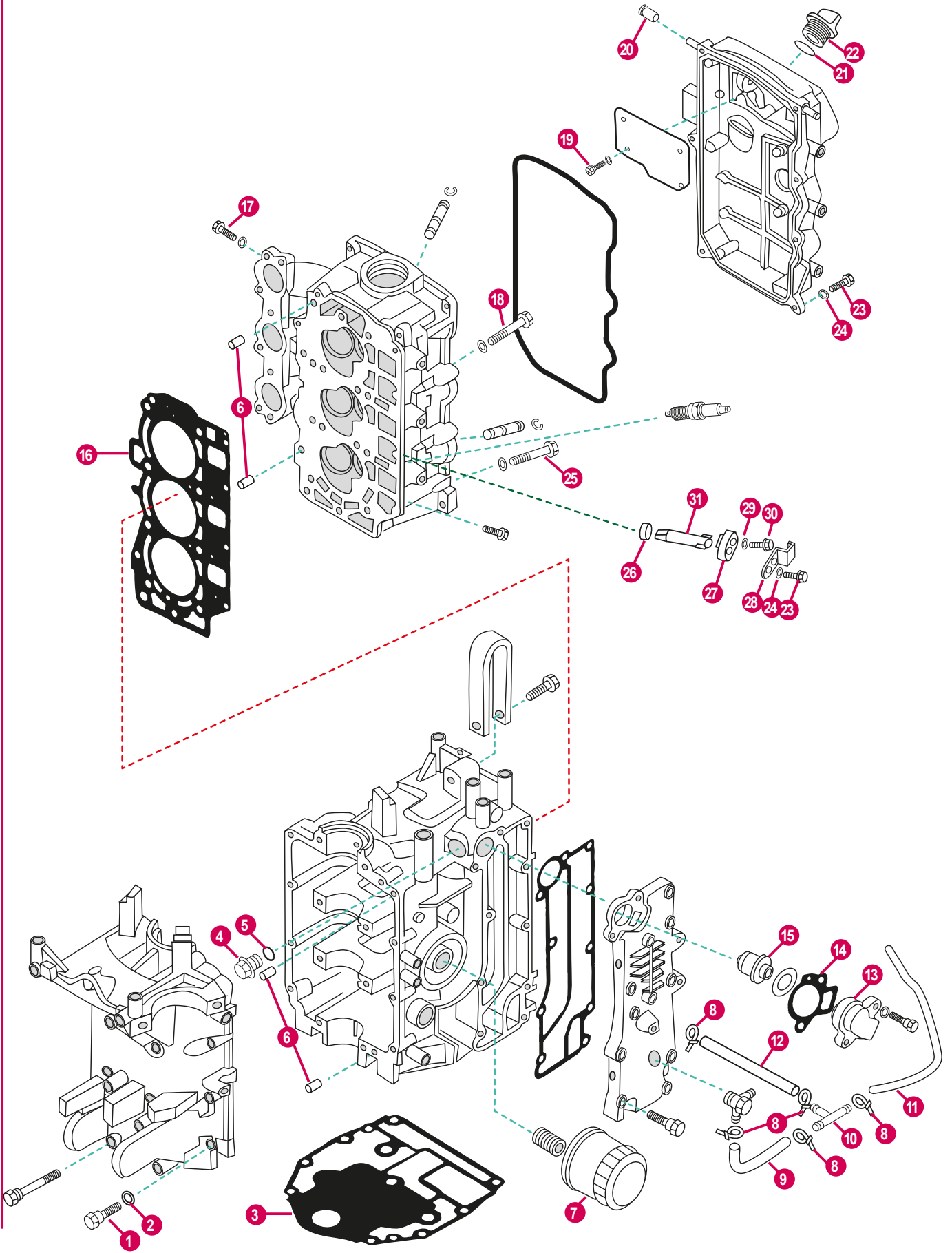

	REF	OEM			UN.
1	PAF15-07000030	97013-06035	TORNILLO	STUD	8
2	PAGB/T96-6	92903-06600	ARANDELA	WASHER	8
3	REC67C-11351-00	67C-11351-01	JUNTA BASE MOTOR	GASKET ENGINE	1
4	PAF15-04000002	90340-14M06	TORNILLO DRENAJE	BOLT, DISCHARGING OIL	1
5	PAF15-04000003	90430-14115	TÓRICA	O-RING	1
6	PAF25-00000014	99530-08012	PIN CENTRADOR	HOLLOW PIN	4
7	REC5GH-13440-00	5GH-13440-00	FILTRO ACEITE	OIL FILTER	1
8	PAHT-2.5X60	90465-11M10	BRIDA	CLAMP	5
9	PAF25-03000008	90445-09068	TUBO DE AGUA	WATER TUBE	1
10	PAF15-05000011	688-24378-00	CONECTOR DE 3 VÍAS	THREE-WAY PIPE	1
11	PAF15-05000014	90445-09104	TUBO DE AGUA	WATER TUBE	1
12	PAF25-03000009	90445-09095	TUBO DE AGUA	WATER TUBE	1
13	PAF15-07010021	6H3-12413-00-1S	TAPA TERMOSTATO	COVER, THERMOSTAT	1
14	REC6H3-12414-A1	62Y-12414-00	JUNTA TAPA TERMOSTATO	GASKET, THERMOSTAT COVER	1
15	PAF15-07000031	6G8-12411-03	TERMOSTATO	THERMOSTAT	1
16	REC67C-11181-01	67C-11181-01	JUNTA CULATA	GASKET, CYLINDER HEAD	1
17	PAGB/T5783-M6X10	97095-06010	TORNILLO	SCREW	3
18	PAF25-05050006	90109-06M65	PERNO	STUD	1
19	PAGB/T818-M4X10	98507-04010	TORNILLO	SCREW	4
20	PAF40-05070002	62Y-14485-00	PIPA DE AGUA	PIPE, WATER	1
21	PAJASOF40431-025	93210-24M79	TÓRICA	O-RING	1
22	PAF15-07050004	6G8-15363-00	TAPÓN ACEITE	PLUG, OIL	1
23	PAGB/T5783-M6X20	97095-06020	TORNILLO	SCREW	7
24	PAGB/T96-6	92995-06600	ARANDELA	WASHER	7
25	PAF25-05000002	90119-09M00	TORNILLO	SCREW	8
26	PAF15-07010009	66M-11328-00	TAPÓN	PLUG	3
27	PAF15-07010011	66M-11327-00-94	TAPA ÁNODO	COVER, ANODE	3
28	PAF15-07010012	66M-12535-00	PLETINA DEL ÁNODO	PLATE, ANODE	3
29	PAGB/T97.1-5	92995-05600	ARANDELA	WASHER	3
30	PAGB/T818-M5X12	97095-05012	TORNILLO	SCREW	3
31	REC62Y-11325-00AL	62Y-11325-00	ÁNODO	ANODE	1
32	PAF4-04000006	90430-08143	JUNTA	GASKET	3

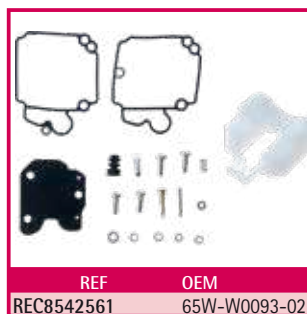
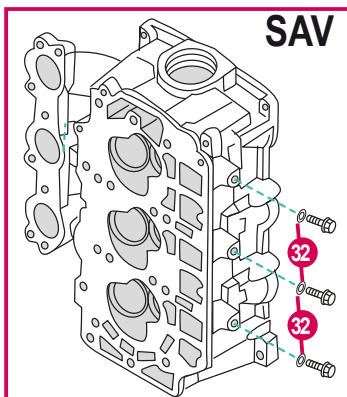

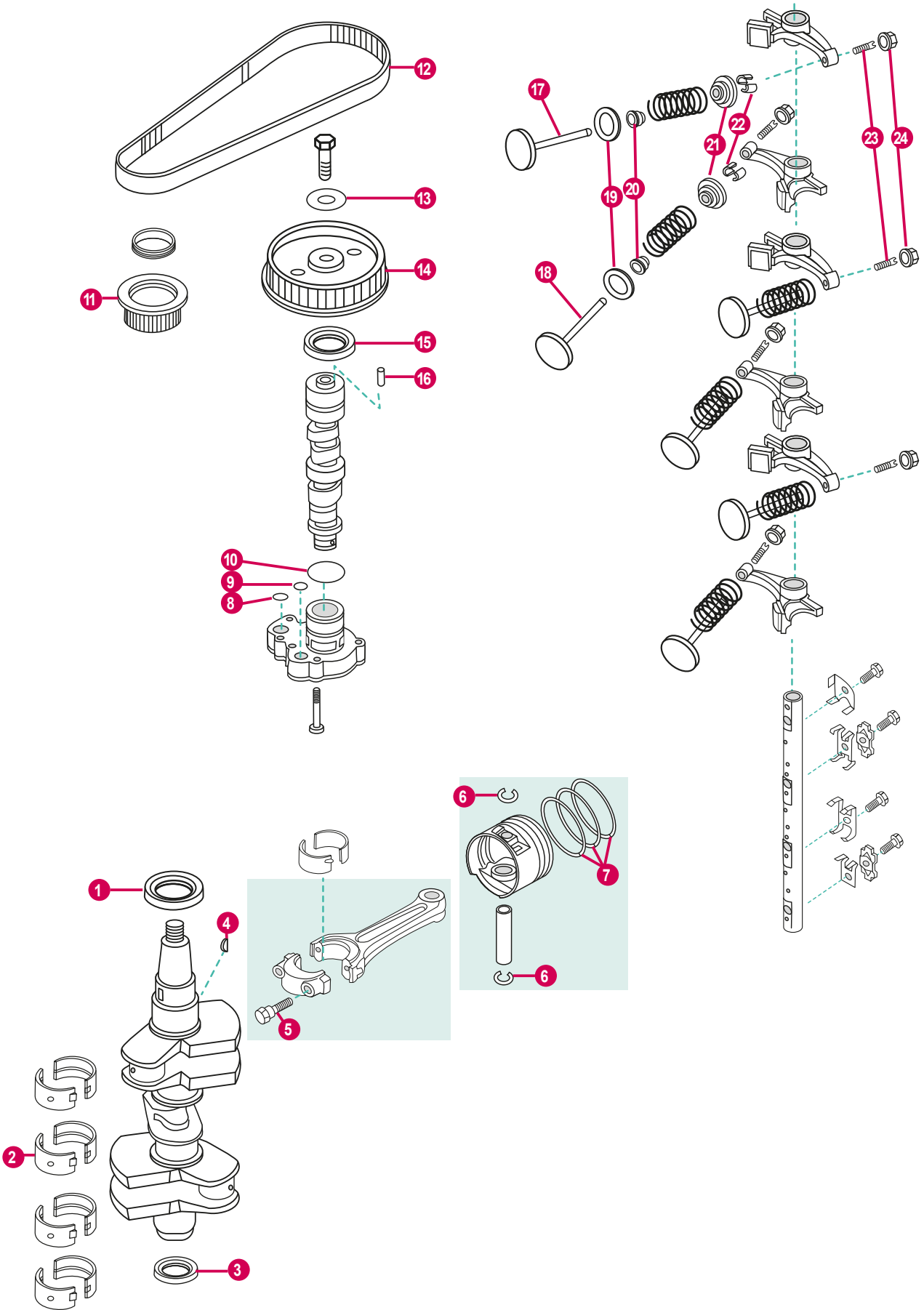

	REF	OEM			UN.
1	PAF25-05020003	93102-43M42	RETÉN DE ACEITE	OIL SEAL	1
2	PAF25-05010302-2	62Y-11416-10	COJINETE BANCADA BLACK	MAIN BEARING BLACK	8
3	PAF25-05020002	93102-35M47	RETÉN DE ACEITE	OIL SEAL	1
4	PAF25-05000024	90280-04M06	CUÑA	KEY WOODRUFF	1
5	PAF25-05020204	62Y-11654-00	TORNILLO	SCREW	2
6	PAF25-05020106	93450-17129	CIRCLIP	CIRCLIP	6
7	REC67C-11603-00	67C-11603-00	KIT SEGMENTOS DE PISTÓN	PISTON RING KIT	3
8	PAF25-05050014	93210-14515	TÓRICA	O-RING	1
9	PAF25-05050013	93210-12MG9	TÓRICA	O-RING	1
10	PAF25-05050015	93210-33MH2	TÓRICA	O-RING	1
11	PAF25-05000021	65W-11536-10	ENGRANAJE DE DISTRIBUCIÓN	BELT PULLEY, TIMING	1
12	REC65W-46241-00	65W-46241-00	CORREA DISTRIBUCIÓN	BELT, TIMING	1
13	PAF25-05050018	90201-10M06	ARANDELA	WASHER	1
14	PAF40-05040006	67C-11537-01	POLEA DE CORREA	BELT PULLEY, DRIVEN	1
15	PAF25-05050021	93102-37M40	RETÉN DE ACEITE	OIL SEAL	1
16	PAF25-05050016	93605-14143	PIN CENTRADOR	HOLLOW PIN	1
17	PAF25-05050002	62Y-12121-00	VÁLVULA ESCAPE	VALVE, EXHAUST	3
18	PAF25-05050001	67C-12111-00	VÁLVULA ADMISIÓN	VALVE, INTAKE	3
19	PAF25-05050003	62Y-12116-00	ARANDELA ASIENTO	SEAT, VALVE SPRING	6
20	PAF166-010003	51Y-12119-00	RETÉN DE ACEITE	OIL SEAL	6
21	PAF15-07040006	30X-12117-00	RETÉN RESORTE	SPRING, VALVE RETAINER	6
22	PAF15-07040007	30X-12118-00	SEGURO DE VÁLVULA	CLAMP, VALVE	12
23	PAF15-07040303	62Y-12159-00	TORNILLO REGULADOR	SCREW, VALVE ADJUSTING	6
24	PAF15-07040304	62Y-12158-00	TUERCA	LOCK NUT	6

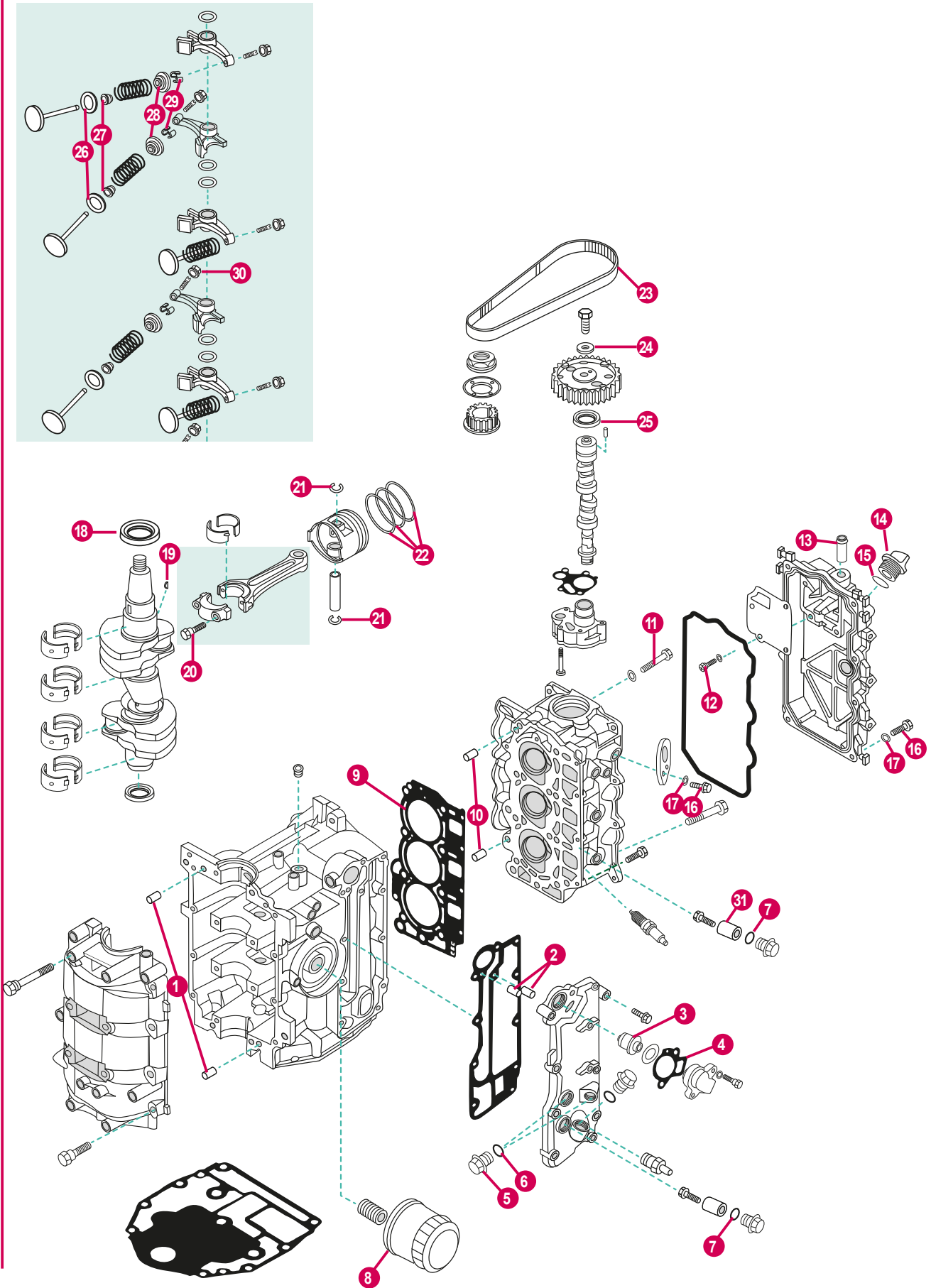

	REF	OEM			UN.
1	REC93606-12019	93606-12019	PIN CENTRADOR	HOLLOW PIN	4
2	PAF15-0000013	93604-10M03	PIN CENTRADOR	HOLLOW PIN	2
3	PAF15-07000031	6G8-12411-03	TERMOSTATO	THERMOSTAT	1
4	REC6H3-12414-A1	62Y-12414-00	JUNTA TAPA TERMOSTATO	GASKET, THERMOSTAT COVER	1
5	PAF15-04000002	90340-14M06	TORNILLO DRENAJE	BOLT, DISCHARGING OIL	2
6	PAF15-04000003	90430-14115	TÓRICA	O-RING	2
7	PAGB/T3452.1-13X2	93210-13M63	TÓRICA	O-RING	5
8	REC5GH-13440-60	5GH-13440-50	FILTRO ACEITE	OIL FILTER	1
9	REC6BG-11181-00	6BG-11181-00	JUNTA CULATA	GASKET, CYLINDER HEAD	1
10	PAF25-0000014	99530-08012	PIN CENTRADOR	HOLLOW PIN	2
11	PAF25-05050006	90109-06M65	PERNO	STUD	1
12	PAGB/T818-M4X10	98507-04010	TORNILLO	SCREW	4
13	PAF40-05070002	62Y-14485-00	PIPA DE AGUA	PIPE, WATER	1
14	PAF15-07050004	6G8-15363-00	TAPÓN ACEITE	PLUG, OIL	1
15	PAJASOF40435-022	93210-24M79	TÓRICA	O-RING	1
16	PAGB/T5783-M6X20	97095-06020	PERNO	STUD	9
17	PAGB/T96-6	92995-06600	ARANDELA	WASHER	9
18	PAF25-05020003	93102-43M42	RETÉN DE ACEITE	OIL SEAL	1
19	PAGB/T1099-3X5X13	90280-03017	CUÑA	KEY WOODRUFF	1
20	PAF25-05020204	6C5-11654-00	TORNILLO	SCREW	2
21	PAF25-05020106	93450-17129	CIRCLIP	CIRCLIP	6
22	REC67C-11603-00	67C-11603-00	KIT SEGMENTOS DE PISTÓN	PISTON RING KIT	3
23	REC6C5-46241-00	6C5-46241-00	CORREA	BELT	1
24	PAF25-05050018	90201-10144	ARANDELA	WASHER	1
25	PAF25-05050021	93102-37M40	RETÉN DE ACEITE	OIL SEAL	1
26	PAF25-05050003	62Y-12116-00	ARANDELA ASIENTO	SEAT, VALVE SPRING	6
27	PAF166-010003	51Y-12119-00	RETÉN DE ACEITE	OIL SEAL	6
28	PAF15-07040006	30X-12117-00	RETÉN RESORTE	SPRING, VALVE RETAINER	6
29	PAF15-07040007	30X-12118-00	SEGURO DE VÁLVULA	CLAMP, VALVE	12
30	PAF15-07040304	62Y-12158-00	TUERCA	LOCK NUT	1
31	REC6G8-11325-00AL	6G8-11325-00	ÁNODO	ANODE	1

4T
STROKES

F40D • F50F/H • F60C/T/F

YAMAHA

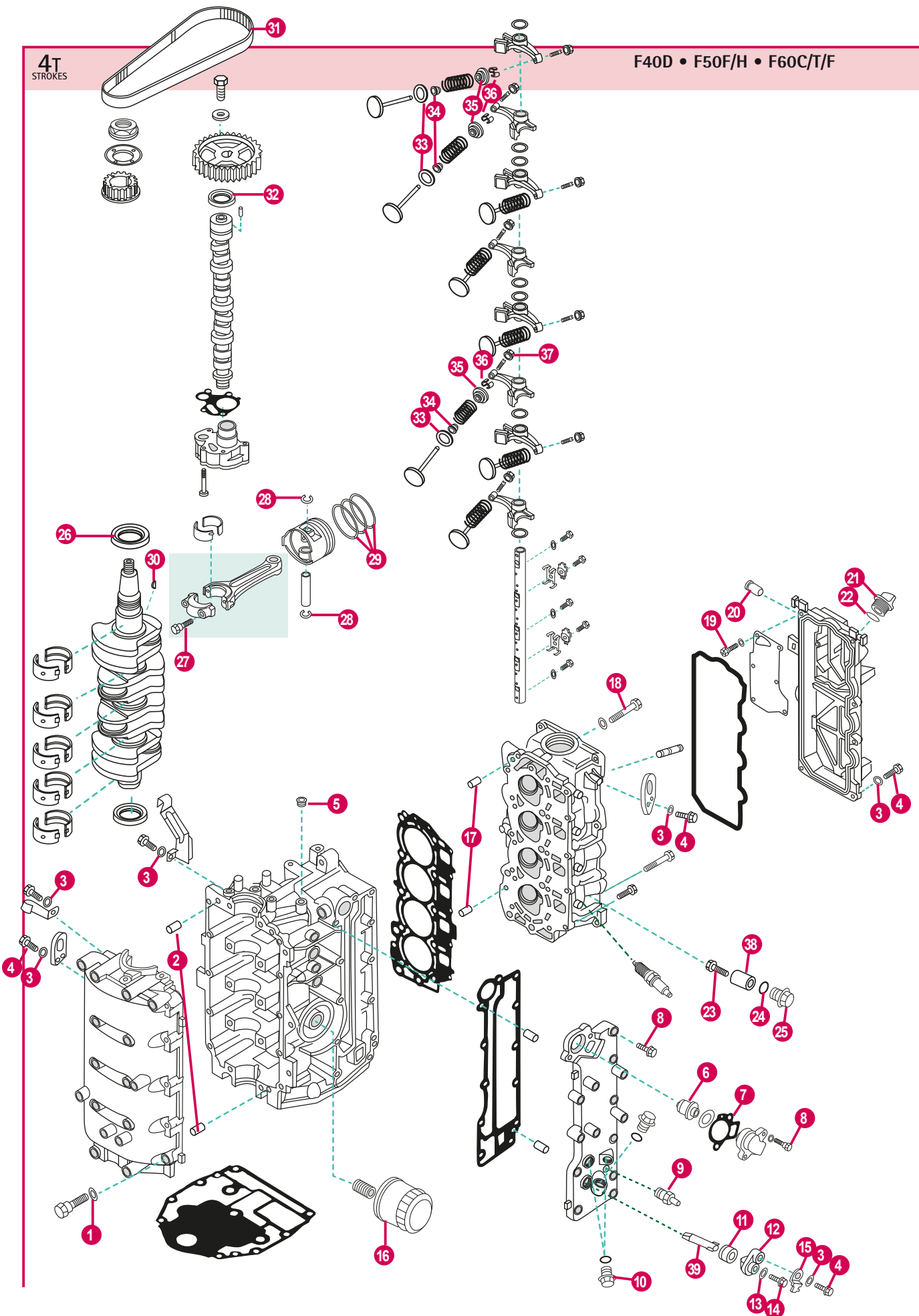

	REF	OEM			UN.
1	PAGB/T848-6	92903-06600	ARANDELA	WASHER	10
2	REC93606-12019	93606-12019	PIN CENTRADOR	HOLLOW PIN	4
3	PAGB/T96-6	92995-06600	ARANDELA	WASHER	14
4	PAGB/T5783-M6X20	97095-06020	PERNO	STUD	12
5	PAF15-07010004	90344-51003	TAPÓN	CAP	1
6	PAF15-07000031	6G8-12411-03	TERMOSTATO	THERMOSTAT	1
7	REC6H3-12414-A1	62Y-12414-00	JUNTA TAPA TERMOSTATO	GASKET, THERMOSTAT COVER	1
8	PAGB/T5782-M6X35	90119-06MA5	TORNILLO	SCREW	12
9	PAF25-05010113	62Y-12481-10	NIPLE DE MANGUERA	NIPPLE	1
10	PAF15-04000002	90340-14M06	TORNILLO DRENAJE	BOLT, DISCHARGING OIL	2
11	PAF15-07010009	66M-11328-00	TAPÓN	CAP	1
12	PAF15-07010011	66M-11327-00-94	TAPA ÁNODO	COVER, ANODE	1
13	PAGB/T97.1-8	92995-05600	ARANDELA	WASHER	1
14	PAGB/T818-M5X12	97095-05012	PERNO	STUD	1
15	PAF15-07010012	66M-12535-00	EMPAQUETADURA DE ÁNODO	PLATE, ANODE	14
16	REC5GH-13440-60	5GH-13440-20	FILTRO ACEITE	OIL FILTER	1
17	PAF25-00000014	99530-08012	PIN CENTRADOR	HOLLOW PIN	2
18	PAF25-05050006	90109-06M65	PERNO	STUD	1
19	PAGB/T818-M4X10	98507-04010	TORNILLO	SCREW	6
20	PAF40-05070002	62Y-14485-00	PIPA DE AGUA	PIPE, WATER	1
21	PAF15-07050004	6G8-15363-00	TAPÓN ACEITE	PLUG, OIL	1
22	PAJASOF40435-022	93210-24M79	TÓRICA	O-RING	1
23	PAGB/T818-M5X25	97880-05025	TORNILLO	SCREW	4
24	PAGB/T3452.1-13X2	93210-13M63	TÓRICA	O-RING	4
25	PAF20-05030009	6G8-11197-01	TAPÓN	CAP	4
26	PAF25-05020003	93102-43M42	RETÉN DE ACEITE	OIL SEAL	1
27	PAF25-05020204	6C5-11654-00	TORNILLO	SCREW	2
28	PAF25-05020106	93450-17129	CIRCLIP	CIRCLIP	8
29	REC67C-11603-00	67C-11603-00	KIT SEGMENTOS DE PISTÓN	PISTON RING KIT	4
30	PAGB/T1099-3X5X13	90280-03M01	CHAVETA	KEY WOODRUFF	1
31	REC6C5-46241-00	6C5-46241-00	CORREA DISTRIBUCIÓN	BELT, TIMING	1
32	PAF25-050500021	93102-37M40	RETÉN DE ACEITE	OIL SEAL	1
33	PAF25-05050003	62Y-12116-00	ARANDELA ASIENTO	SEAT, VALVE SPRING	8
34	PAF166-010003	51Y-12119-00	RETÉN DE ACEITE	OIL SEAL	8
35	PAF15-07040006	30X-12117-00	RETÉN RESORTE	SPRING, VALVE RETAINER	8
36	PAF15-07040007	30X-12118-00	SEGURO DE VÁLVULA	CLAMP, VALVE	16
37	PAF15-07040304	62Y-12158-00	TUERCA	LOCK NUT	1
38	REC6G8-11325-00AL	6G8-11325-00	ÁNODO	ANODE	1
39	REC62Y-11325-00AL	62Y-11325-00	ÁNODO	ANODE	1

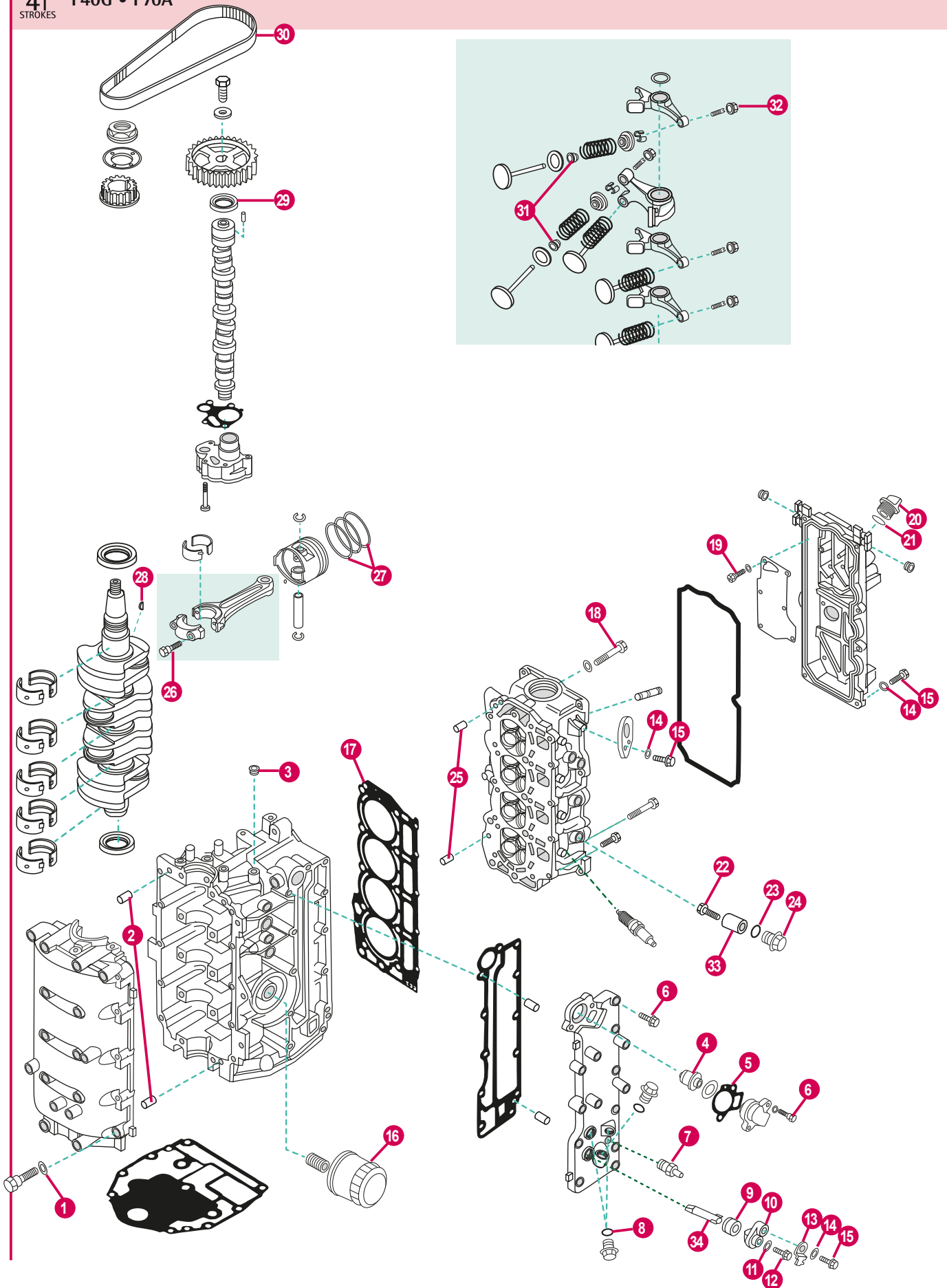

	REF	OEM			UN.
1	PAGB/T848-6	92903-06600	ARANDELA	WASHER	10
2	REC93606-12019	90606-12019	PIN CENTRADOR	HOLLOW PIN	4
3	PAF15-07010004	90344-51003	TAPÓN	CAP	1
4	PAF15-07000031	6G8-12411-03	TERMOSTATO	THERMOSTAT	1
5	REC6H3-12414-A1	62Y-12414-00	JUNTA TAPA TERMOSTATO	GASKET, THERMOSTAT COVER	1
6	PAGB/T5782-M6X35	90119-06MA5	ARANDELA	WASHER	12
7	PAF25-05010113	62Y-12481-10	NIPLE DE MANGUERA	NIPPLE	1
8	PAF15-04000002	90340-14M06	TORNILLO DRENAJE	BOLT, DISCHARGING OIL	2
9	PAF15-07010009	66M-11328-00	TAPÓN	CAP	1
10	PAF15-07010011	66M-11327-00-94	TAPA ÁNODO	COVER, ANODE	1
11	PAGB/T97.1-8	92995-05600	ARANDELA	WASHER	1
12	PAGB/T818-M5X12	97095-05012	PERNO	STUD	1
13	PAF15-07010012	66M-12535-00	EMPAQUETADURA DE ÁNODO	PLATE, ANODE	1
14	PAGB/T96-6	92995-06600	ARANDELA	WASHER	1
15	PAGB/T5783-M6X20	97095-06020	PERNO	STUD	3
16	REC5GH-13440-60	5GH-13440-50	FILTRO ACEITE	OIL FILTER	1
17	REC6CJ-11181-00	6CJ-11181-00	JUNTA CULATA	GASKET, CYLINDER HEAD	1
18	PAF25-05050006	90109-06M65	PERNO	STUD	1
19	PAGB/T818-M4X10	98507-04010	TORNILLO	SCREW	6
20	PAF15-07050004	6G8-15363-00	TAPÓN ACEITE	PLUG, OIL	1
21	PAJASOF40435-022	93210-24M79	TÓRICA	O-RING	1
22	PAGB/T818-M5X25	97880-05025	TORNILLO	SCREW	3
23	PAGB/T3452.1-13X2	93210-13M63	TÓRICA	O-RING	3
24	PAF20-05030009	6G8-11197-01	TAPÓN	CAP	3
25	PAF25-00000014	99530-08012	PIN CENTRADOR	HOLLOW PIN	2
26	PAF25-05020204	6C5-11654-00	TORNILLO	SCREW	2
27	REC67C-11603-00	67C-11603-00	KIT SEGMENTOS DE PISTÓN	PISTON RING KIT	4
28	PAGB/T1099-3X5X13	90280-03M01	CHAVETA	KEY WOODRUFF	1
29	PAF25-05050021	93102-37M40	RETÉN DE ACEITE	OIL SEAL	1
30	REC6C5-46241-00	6C5-46241-00	CORREA DISTRIBUCIÓN	BELT, TIMING	1
31	PAF166-010003	51Y-12119-00	RETÉN DE ACEITE	OIL SEAL	16
32	PAF15-07040304	62Y-12158-00	TUERCA	LOCK NUT	8
33	REC6G8-11325-00AL	6G8-11325-00	ÁNODO	ANODE	1
34	REC62Y-11325-00AL	62Y-11325-00	ÁNODO	ANODE	1

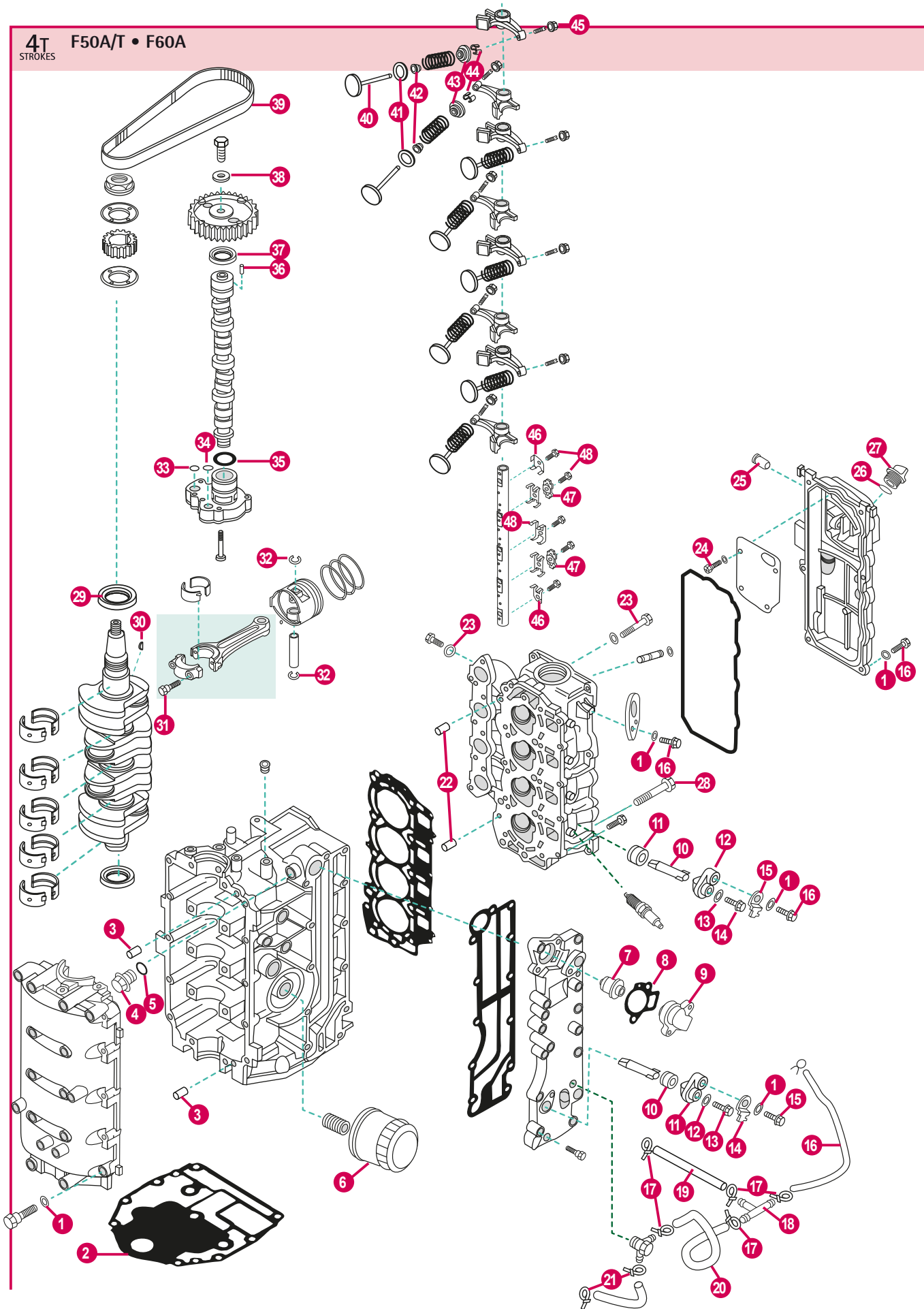

	REF	OEM			UN.
1	PAGB/T96-6	92903-06600	ARANDELA	WASHER	22
2	REC67C-11351-00	67C-11351-01	JUNTA BASE MOTOR	GASKET ENGINE	1
3	REC93606-12019	93606-12019	PIN CENTRADOR	HOLLOW PIN	4
4	PAF15-04000002	90340-14M06	TORNILLO DRENAJE	BOLT, DISCHARGING OIL	1
5	PAF15-04000003	90430-14115	TÓRICA	O-RING	1
6	REC5GH-13440-00	5GH-13440-10	FILTRO ACEITE	OIL FILTER	1
7	PAF15-07000031	6G8-12411-03	TÓRICA	O-RING	1
8	REC6H3-12414-A1	62Y-12414-00	JUNTA TAPA TERMOSTATO	GASKET, THERMOSTAT COVER	1
9	PAF15-07010021	6H3-12413-00-15	TAPA TERMOSTATO	COVER, THERMOSTAT	1
10	PAF15-07010009	66M-11328-00	TAPÓN	CAP	2
11	PAF15-07010011	66M-11327-00-94	TAPA ÁNODO	COVER, ANODE	2
12	PAGB/T97.1-5	92995-05600	ARANDELA	WASHER	1
13	PAGB/T818-M5X12	97095-05012	PERNO	STUD	1
14	PAF15-07010012	66M-12535-00	EMPAQUETADORA DE ÁNODO	PLATE, ANODE	1
15	PAGB/T5783-M6X20	97095-06020	PERNO	STUD	12
16	PAF15-05000014	90445-09104	TUBO DE AGUA	WATER TUBE	1
17	PAHT-2.5X60	90465-11M10	BRIDA	CLAMP	5
18	PAF15-05000011	688-24378-00	CONECTOR DE 3 VÍAS	THREE-WAY PIPE	1
19	PAF25-03000009	90445-09095	TUBO DE AGUA	WATER TUBE	1
20	PAF25-03000008	90445-09068	TUBO DE AGUA	WATER TUBE	1
21	PAHT-2.5X60	90465-11M10	BRIDA	CLAMP	2
22	PAF25-00000014	99530-08012	PIN CENTRADOR	HOLLOW PIN	2
23	PAF25-05050006	90109-06M65	TORNILLO	SCREW	1
24	PAGB/T818-M4X10	98507-04010	TORNILLO	SCREW	4
25	PAF40-05070002	62Y-14485-00	PIPA DE AGUA	PIPE, WATER	1
26	PAF15-07050004	6G8-15363-00	TAPÓN ACEITE	PLUG, OIL	1
27	PAJASOF40431-025	93210-24M79	TÓRICA	O-RING	1
28	PAF25-05000002	90119-09M00	TORNILLO CON ARANDELA	BOLT, FLANGE	10
29	PAF25-05020003	93102-43M42	RETÉN DE ACEITE	OIL SEAL	1
30	PAF4-04000019	90280-04M06	CUÑA	KEY WOODRUFF	1
31	PAF25-05020204	6C5-11654-00	TORNILLO	SCREW	2
32	PAF25-05020106	93450-17129	CIRCLIP	CIRCLIP	8
33	PAF25-05050014	93210-14515	PISTÓN, CONTRA	PISTON, BALANCE	1
34	PAF25-05050013	93210-12MG9	TÓRICA	O-RING	1
35	PAF25-05050015	93210-33MH2	TÓRICA	O-RING	1
36	PAF25-05050016	93605-14143	PIN CENTRADOR	HOLLOW PIN	1
37	PAF25-05050021	93102-37M40	RETÉN DE ACEITE	OIL SEAL	1
38	PAF25-05050018	90201-10M06	ARANDELA	WASHER	1
39	REC62Y-46241-00	62Y-46241-00	CORREA DISTRIBUCIÓN	BELT, TIMING	1
40	PAF25-05050002	62Y-12121-00	VÁLVULA ESCAPE	VALVE, EXHAUST	4
41	PAF25-05050003	62Y-12116-00	ARANDELA ASIENTO	SEAT, VALVE SPRING	8
42	PAF166-010003	51Y-12119-00	RETÉN DE ACEITE	OIL SEAL	8
43	PAF15-07040006	30X-12117-00	RETÉN RESORTE	SPRING, VALVE RETAINER	8
44	PAF15-07040007	30X-12118-00	SEGURO DE VÁLVULA	CLAMP, VALVE	16
45	PAF15-07040304	62Y-12158-00	TUERCA	LOCK NUT	8
46	PAF25-05050009	62Y-12238-00	PLACA TOPE DE PERNO	PLATE, BOLT STOPPER	2
47	PAF25-05050012	62Y-12231-00	TOPE DE GUÍA	PLATE, BOLT STOPPER	2
48	PAF40-05040003	62Y-12279-00	PLACA EJE DE BALANCINES	FIXED PLATE B, ROCKER SHAFT	1

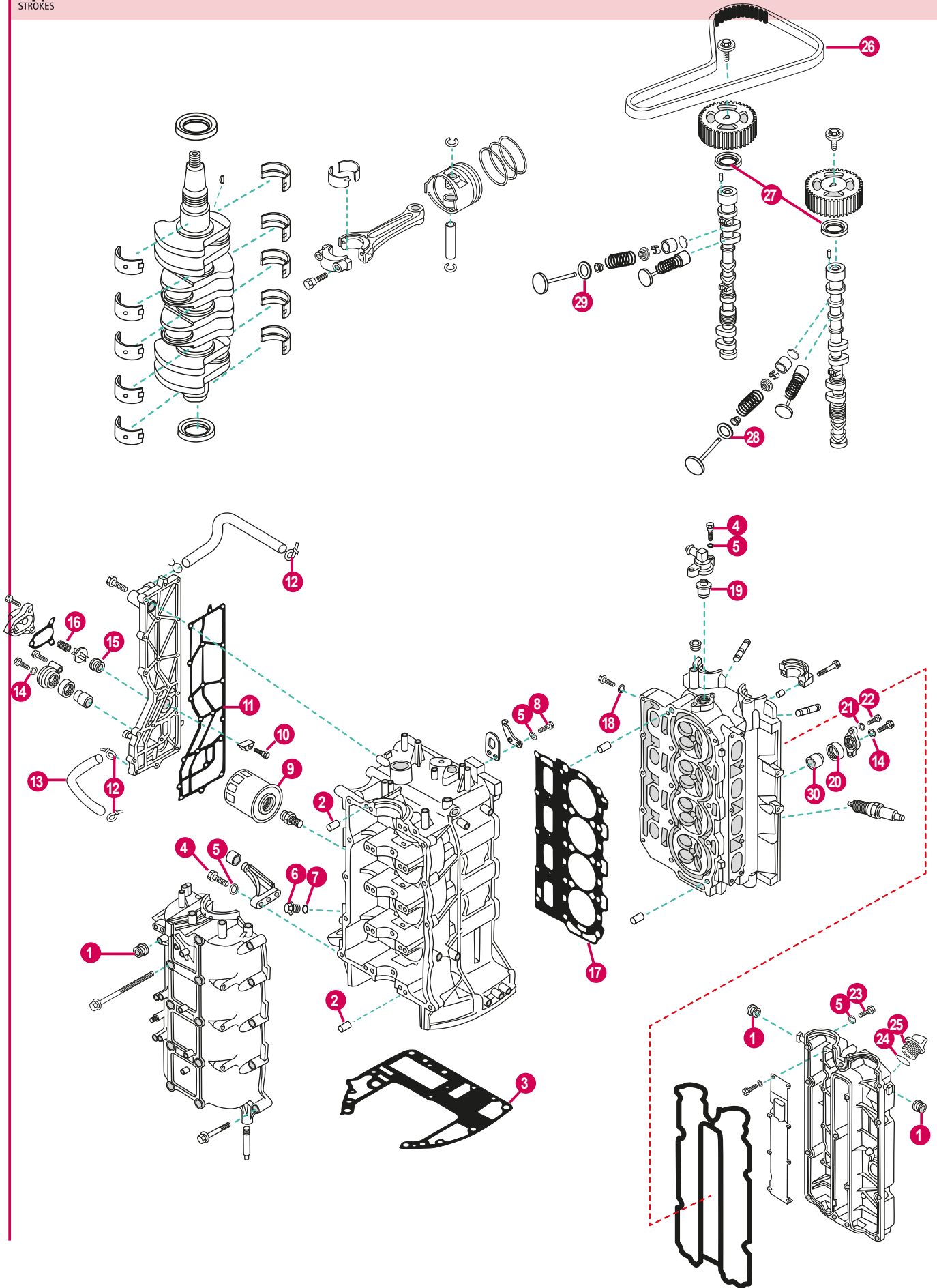

	REF	OEM			UN.
1	PAF15-07010027	90480-12072	TAPÓN	CAP	3
2	REC93606-12019	93606-12019	PIN CENTRADOR	HOLLOW PIN	24
3	REC68V-11351-00	68V-11351-00	JUNTA BASE MOTOR	GASKET ENGINE	1
4	PAGB/T5782-M6X25	97095-06025	TORNILLO	SCREW	6
5	PAGB/T96-6	92995-06600	ARANDELA	WASHER	24
6	PAF15-04000002	90340-14M06	TORNILLO DRENAJE	BOLT, DISCHARGING OIL	1
7	PAF15-04000003	90430-14115	TÓRICA	O-RING	1
8	PAGB/T5783-M6X20	97095-06020	TORNILLO	SCREW	4
9	REC5GH-13440-00	5GH-13440-00	FILTRO ACEITE	OIL FILTER	1
10	PAGB/T820-M4X12	98780-04016	TORNILLO	SCREW	3
11	REC67F-41114-A2	6D8-41114-A0	JUNTA	GASKET	1
12	PAHT-2.5X60	90465-11M10	BRIDA	CLAMP	3
13	PAF40-05000053	90445-10M40	TUBO	TUBE	1
14	REC90430-06M03	90430-06M03	JUNTA	GASKET	2
15	REC90480-20M05	90480-20M05	TAPÓN	CAP	1
16	REC90501-16M11	90501-16M11	RESORTE	SPRING	1
17	REC67F-11181-03	67F-11181-02	JUNTA CULATA	GASKET, CYLINDER HEAD	1
18	PAF4-04000006	90430-08143	JUNTA	GASKET	4
19	REC67F-12411-01	67F-12411-01	TERMOSTATO	THERMOSTAT	1
20	REC67F-11328-00	67F-11328-00	TAPÓN	CAP	1
21	PAGB/T97.1-8	92995-08600	ARANDELA	WASHER	4
22	PAGB/T5783-M8X25	97075-08025	PERNO	STUD	4
23	REC90101-06M56	97095-06030	TORNILLO	SCREW	14
24	PAJASOF40431-025	93210-24M79	TÓRICA	O-RING	1
25	PAF15-07050004	6G8-15363-00	TAPÓN ACEITE	PLUG, OIL	1
26	REC67F-46241-00	67F-46241-00	CORREA	BELT	1
27	REC93102-38008	93102-38M59	RETÉN DE ACEITE	OIL SEAL	2
28	RECK0A-A3721-00	K0A-A3721-00	RETÉN DE ACEITE	OIL SEAL	8
29	RECK0A-A3722-00	K0A-A3722-00	RETÉN DE ACEITE	OIL SEAL	8
30	REC6V8-11325-01AL	6V8-11325-01	ÁNODO	ANODE	1

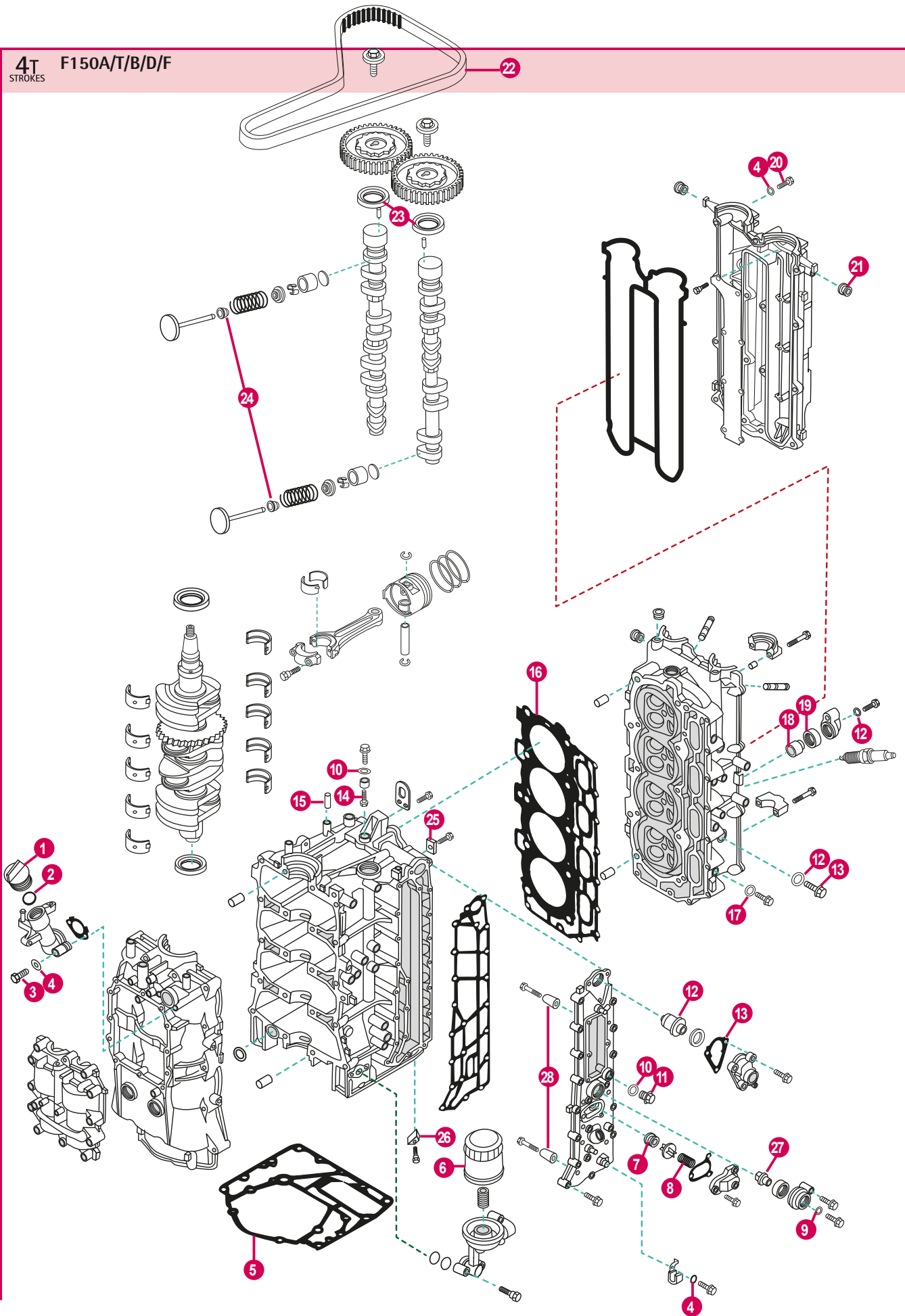

	REF	OEM			UN.
1	PAF15-07050004	6G8-15363-00	TAPÓN ACEITE	PLUG, OIL	1
2	PAJASOF40431-025	93210-24M79	TÓRICA	O-RING	1
3	REC97095-06045	97095-06045	TORNILLO	SCREW	2
4	PAGB/T96-6	92995-06600	ARNADELA	WASHER	15
5	REC63P-11351-01	63P-11351-00	JUNTA BASE MOTOR	GASKET ENGINE	1
6	REC35-822626Q15	69J-13440-01	FILTRO ACEITE	OIL FILTER	1
7	REC90480-20M05	90480-20M05	TAPÓN	CAP	1
8	REC90501-16M11	90501-16M11	RESORTE	SPRING	1
9	REC90430-06M03	90430-06M03	JUNTA	GASKET	2
10	PAF15-04000003	90430-14115	JUNTA	GASKET	1
11	PAF15-04000002	90340-14M06	TORNILLO DRENAJE	BOLT, DISCHARGING OIL	1
12	REC67F-12411-01	67F-12411-01	TERMOSTATO	THERMOSTAT	1
13	REC63P-12414-00	63P-12414-00	JUNTA TAPA TERMOSTATO	GASKET, THERMOSTAT COVER	1
14	PAGB/T818-M5X16	98780-05016	TORNILLO	SCREW	1
15	REC93606-12019	93606-12019	PIN CENTRADOR	HOLLOW PIN	1
16	REC63P-11181-00	63P-11181-00	JUNTA CULATA	GASKET, CYLINDER HEAD	1
17	PAF4-04000006	90430-08143	JUNTA	GASKET	4
18	REC67F-11328-00	67F-11328-00	TAPÓN	CAP	2
19	REC93102-38008	93102-38M59	RETÉN DE ACEITE	OIL SEAL	2
20	PAGB/T5783-M6X30	97095-06030	TORNILLO	SCREW	13
21	PAF15-07010027	90480-12072	TAPÓN	CAP	5
22	REC63P-46241-00	63P-46241-00	CORREA DISTRIBUCIÓN	BELT, TIMING	1
23	REC93102-38008	93102-38008	RETÉN DE ACEITE	OIL SEAL	2
24	REC69J-12119-00	69J-12119-00	RETÉN DE ACEITE	OIL SEAL	16
25	REC63P-11325-11AL	63P-11325-11	ÁNODO	ANODE	1
26	REC63P-11325-01AL	63P-11325-01	ÁNODO	ANODE	1
27	REC67F-11325-01AL	67F-11325-01	ÁNODO	ANODE	1
28	REC68T-11325-00AL	67T-11325-00	ÁNODO	ANODE	2

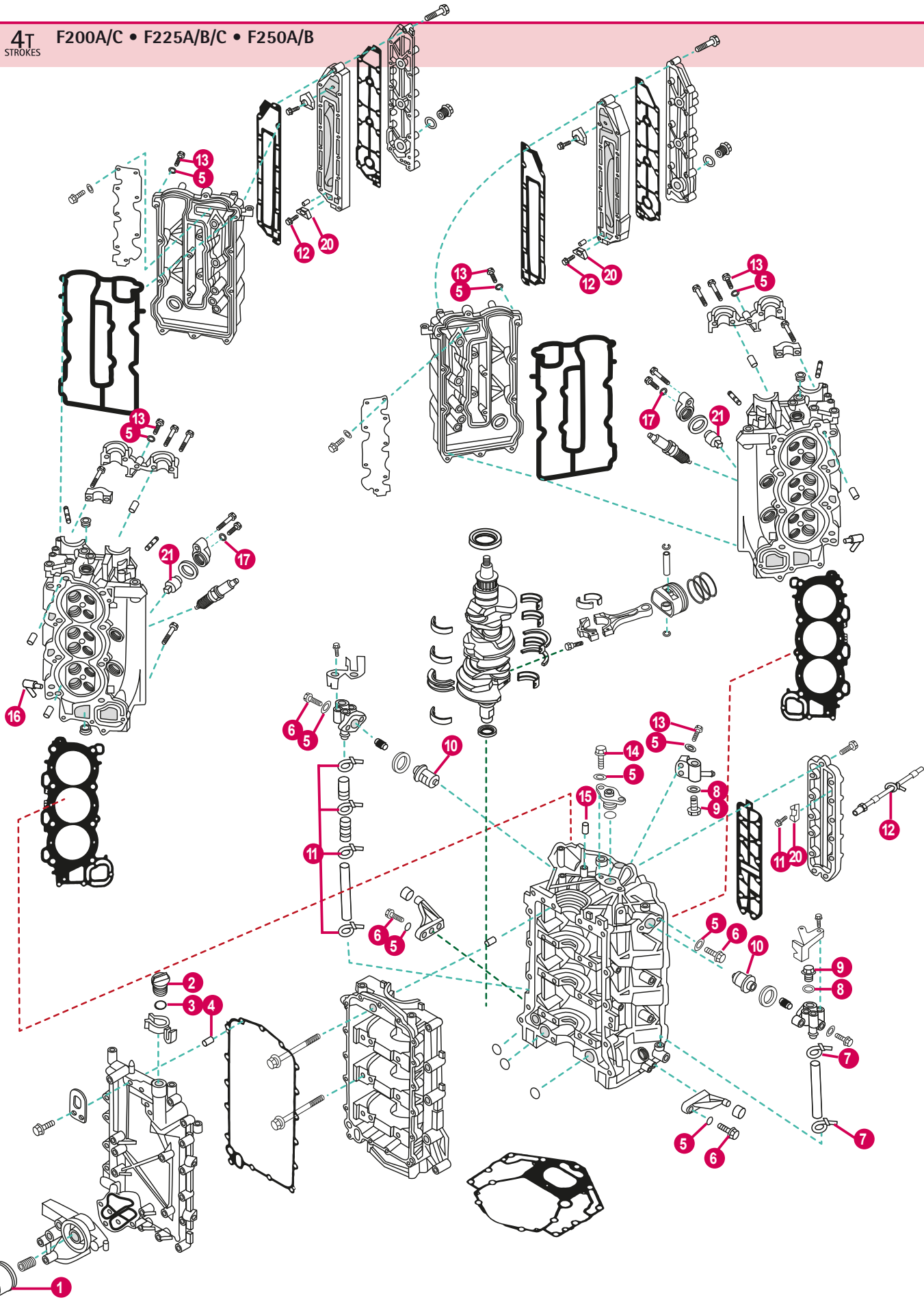

	REF	OEM			UN.
1	REC35-822626Q15	69J-13440-01	FILTRO ACEITE	OIL FILTER	1
2	PAF15-07050004	6G8-15363-00	TAPÓN ACEITE	PLUG, OIL	1
3	PAJASOF40431-025	93210-24M79	TÓRICA	O-RING	1
4	REC93606-12019	93606-12019	PIN CENTRADOR	HOLLOW PIN	2
5	PAGB/T96-6	92995-06600	ARANDELA	WASHER	28
6	PAGB/T5782-M6X25	97095-06025	TORNILLO	SCREW	8
7	REC09401-11425	90465-11M59	BRIDA	CLAMP	6
8	PAF15-04000003	90430-14115	JUNTA	GASKET	2
9	PAF15-04000002	90340-14M06	TORNILLO DRENAJE	BOLT, DISCHARGING OIL	2
10	REC67F-12411-01	67F-12411-01	TERMOSTATO	THERMOSTAT	2
11	PAGB/T820-M4X12	98780-04015	TORNILLO	SCREW	6
12	PAHT-2.5X60	90465-11M10	BRIDA	CLAMP	1
13	PAGB/T5783-M6X30	97095-06030	TORNILLO	SCREW	18
14	PAGB/T5783-M6X20	97095-06020	TORNILLO	SCREW	2
15	REC93606-12019	93606-12019	PIN CENTRADOR	HOLLOW PIN	1
16	PAF15-04000005	676-11372-00	NIPLE DE MANGUERA	NIPPLE	1
17	REC90430-06M03	90430-06M03	JUNTA	GASKET	2
18	PAF166-010003	51Y-12119-00	RETÉN DE ACEITE	OIL SEAL	24
19	REC6P2-46241-02	6P2-46241-01	CORREA DISTRIBUCIÓN	BELT, TIMING	1
20	REC6E5-11325-00AL	6E5-11325-00	ÁNODO	ANODE	3
21	REC67F-11325-01AL	67T-11325-01	ÁNODO	ANODE	2

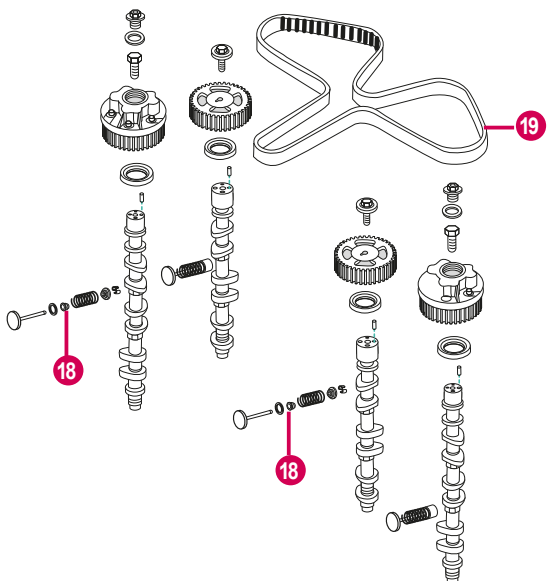

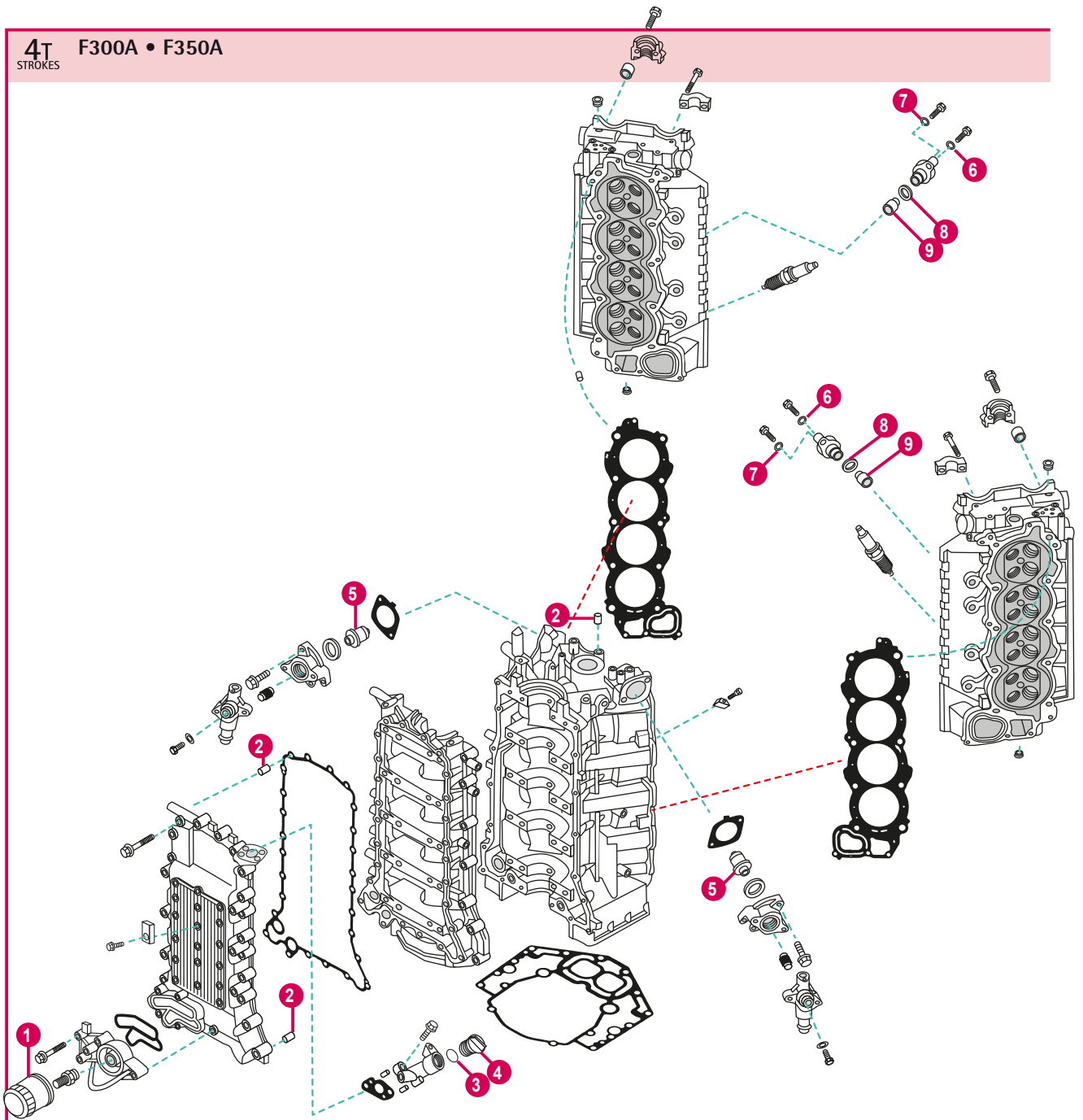

	REF	OEM			UN.
1	REC26-13440-00	N26-13440-00	FILTRO ACEITE	OIL FILTER	1
2	REC93606-12019	93606-12019	PIN CENTRADOR	HOLLOW PIN	5
3	PAJASOF40431-025	93210-24M79	TÓRICA	O-RING	1
4	PAF15-07050004	6G8-15363-00	TAPÓN ACEITE	PLUG, OIL	1
5	REC6AW-12411-00	6AW-12411-00	TERMOSTATO	THERMOSTAT	2
6	REC90430-06M03	90430-06M03	JUNTA	GASKET	2
7	PAGB/T97.1-8	92995-08600	ARANDELA	WASHER	2
8	REC67F-11328-00	67F-11328-00	TAPÓN	CAP	2
9	REC6AW-11325-00AL	6AW-11325-00	ÁNODO	ANODE	2

JUNTAS DE MOTOR 4 TIEMPOS



ENGINE GASKET 4 STROKES



4T
STROKES

JUNTAS DE CULATA



CYLINDER HEAD GASKET



REF	OEM		
PAF2.6-04000001	69M-11181-00	F2.5 (2003+)	

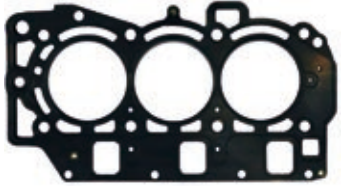

REF	OEM		
PAF25-05040000	65W-11181-30	F20/25 T25 F45/50 (1998-09)	



REF	OEM		
PAF4-04000014	67D-11181-A0	F4 (1998-2009)	



REF	OEM		
REC67C-11181-01	67C-11181-01	F30/40 (2000-09)	



REF	OEM		
PAF6-04000002	6BX-11181-00	F4B/M (2010+) F5A/M (2010+) F6C/M (2010+)	

REF	OEM		
REC6G8-11181-A1	6G8-11181-A1	F8/9.9 (1985-05)	



REF	OEM		
REC6BG-11181-00	6BG-11181-00	F30/40 (2009+)	

REF	OEM		
PAF15-07000100	66M-11181-10	F9.9/13.5/15 (1998-08)	

REF	OEM		
REC6CJ-11181-00	6CJ-11181-00	F40GE/70 (2011+)	

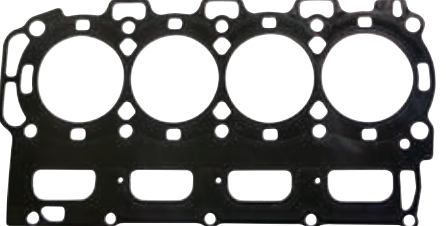
REF	OEM		
REC6AG-11181-00	6AG-11181-00	F9.9/15/20 (2007+)	

REF	OEM		
REC67F-11181-03	67F-11181-03	F75/80/100/115 (1999+)	

REF	OEM		
REC6BL-11181-00	6BL-11181-00	F20/25 FT25 T25 (2009+)	

YAMAHA

RECMAR®

REF	OEM	
REC63P-11181-00	63P-11181-00	F150 FL150 (2004+)



REF	OEM	
REC6CB-11181-00	6CB-11181-00	F225/250/300 LF-FL225/250/300 (2011+)





JUNTAS BASE DE MOTOR

CYLINDER GASKET

REF	OEM	
PAF2.6-00000003	69M-45113-A0	F2.5





REF	OEM	
REC65W-11351-10	65W-11351-10	F20 F25 T/FT25

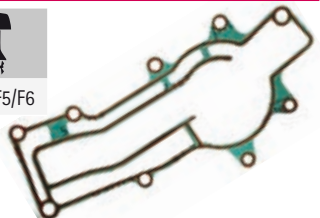

REF	OEM	
PAF6-00000001	6BX-45113-00	F4/F5/F6





REF	OEM	
REC6AH-11351-00	6AH-11351-10	F9.9 F13.5 F15 F20



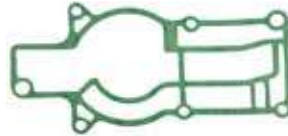

REF	OEM	
PAF4-00000006	67D-45113-A0	F4





REF	OEM	
REC67C-11351-00	67C-11351-01	F40 T/FT50 F50 T/FT60 F30 F60



REF	OEM	
PAF15-00000014	66M-11351-10	T/FT9.9 F9.9 F15 F13.5





REF	OEM	
REC68V-11351-00	68V-11351-00	F75 F80 F90 F115 F100

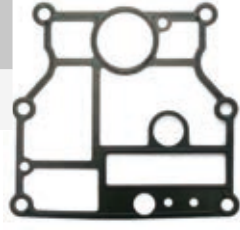

REF	OEM	
PAF15-00000014	66M-11351-10	T/FT 9.9 F9.9 F8



REF	OEM	
REC63P-11351-01	63P-11351-01	F150 F175 F200



4T
STROKES

GUÍA JUNTAS DE MOTOR

ENGINE GASKET GUIDE

		CYL	JUNTA CULATA CYLINDER HEAD GASKET		KIT	JUNTA BASE MOTOR CYLINDER GASKET
F2.6A/M	2003	1	PAF2.6-04000001			PAF2.6-00000003
F4A/M	1998	1	PAF4-04000014			PAF4-00000006
F8A/B	1985-99	2	REC6G8-11181-A1			REC6G8-11351-A0
F9.9A/B	1985-99	2	REC6G8-11181-A1			REC6G8-11351-A0
F9.9C	2001-07	2	PAF15-07000100			PAF15-00000014
F9.9H	2008	2	REC6AG-11181-00			REC6AH-11351-00
FT9.9D, F13.5 A	2001-07	2	PAF15-07000100			PAF15-00000014
F13.5B, F15C/E/M	2008	2	REC6AG-11181-00			REC6AH-11351-00
F15A/E/M/P	2001-07	2	PAF15-07000100			PAF15-00000014
F20B/E/M	2008	2	REC6AG-11181-00			REC6AH-11351-00
F20D	2011	2	REC6BL-11181-00			
F20A	1998	2	PAF25-05040000	REC65W-W0001-00		REC65W-11351-10
T25/F25A/A/E/M	1998-09	2	PAF25-05040000	REC65W-W0001-00		REC65W-11351-10
T25/F25D/M/F	2009	2	REC6BL-11181-00			
F30A/E/TR, F40B/E/TR	2000-09	3	REC67C-11181-01			REC67C-11351-00
F30B, F40F	2009	3	REC6BG-11181-00			
F40G, F70A	2011	4	REC6CJ-11181-00			
F80A/B/C/TLR	1999	4	REC67F-11181-03			REC68V-11351-00
F100A/B/D/TLR	1999	4	REC67F-11181-03			REC68V-11351-00
F115A/TX/TLR	2000	4	REC67F-11181-03			REC68V-11351-00
F150A/T/B	2004	4	REC63P-11181-00			REC63P-11351-01
F17A	2014	4				REC63P-11351-01
F200B/F/G/CA	2013	4				REC63P-11351-01
F225CA/F, F250CA/D	2011	6	REC6CB-11181-00			
F300B/CA	2011	6	REC6CB-11181-00			

4T
STROKES

KITS JUNTAS DE CULATA

CYLINDER HEAD GASKET KIT

REF	OEM	
REC65W-W0001-00	65W-W0001-00	F20/25 (1998-01) T25/FT25 (2000-01)

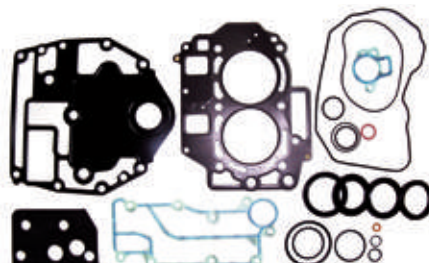

CIGÜEÑAL

CRANKSHAFT

4T
STROKES

GUÍA CIGÜEÑAL COMPLETO

GUIDE CRANKSHAFT ASSY

4T STROKES		REF
F2.5	2003-13	PAF2.6-04030000
F4	1998-09	PAF4-04030000
F9.9	1998-09	PAF15-07030000
F9.9	2009-19	PAF20-05020004
F13.5	1999-07	PAF15-07030000
F13.5	2007-09	PAF20-05020004
F15	1998-07	PAF15-07030000
F15	2007-19	PAF20-05020004
F20	2007-19	PAF20-05020004

RETÉN

SEAL OIL

REF	OEM	
REC93101-13M37	9310113M3700	20, 25N/M/D (1998-16)



YAMAHA

RECMAR®

985





PISTONES

PISTONS





4T
STROKES

KITS DE PISTONES





PISTON KITS

STD		REF	OEM	
REF	OEM			
	PAF2.6-04020001	69M-E1631-01-96		F2.5AMH/MLH/MH/MSH (2004+)
	REC69M-E1603-01	69M-E1 603-01		
	PAF2.6-04020005	69M-E1633-00		







STD		REF	OEM	
REF	OEM			
	PAF15-07020001	66M-11631-00-96		F9.9C/CE/CMH/CWH/D (1998-08) F13.5AMH/AEH/AEP (2000-07) FT/F15A/PR/PLR/AEP/ELH/MH/AE/AM (2000-07)
	REC66N-11603-00	66N-11603-00		
	PAF15-07020006	634-11633-00		
	PAF15-07020005	93450-15023		







STD		REF	OEM	
REF	OEM			
	PAF4-04020200	68D-E1631-00-96		F4A/MSHA/AMH/MLHB-D/MH (2002-09)
	REC68D-E1603-00	68D-E1603-00		
	PAF4-04020005	68D-E1633-00		
	PAF4-04020006	93450-14088		



STD		REF	OEM	
REF	OEM			
		65W-11631-00-96		F20AES/AET/AE-S (2003-06) F25ELH/AE/AW/A/AET/MHZ/MHA/AM/AEH/A-ES/ T25ELRZ-T/FT25B (1998-09) F30A/ERZ/MLH/AET/ELHB/AMH/TR/AWH/ETL (2001-09) F40B/ELH/BE/ERZ/ERA/BMH/BWH (2000-09)
	REC67C-11603-00	67C-11603-00		
		62Y-11633-00		
	PAF25-05020106	93450-17129		



STD		REF	OEM	
REF	OEM			
	PAF20-05020001	6AH-11631-00		F9.9 HMH, HE (2009+) F13.5 B, BMH (2007-09) F15 CMH, MH, ELH, CWH, CE (2007+) F20 BMH, ELH, BE, MH (2007+)
	PAF20-05020100	6AH-11603-00		
	PAF20-05020003	137-11633-10		
	PAF20-05020002	93450-17129		



DESPIECE MOTOR DE 2 TIEMPOS

ENGINE PARTS 2 STROKES

2T
STROKES 2B • 2MSH

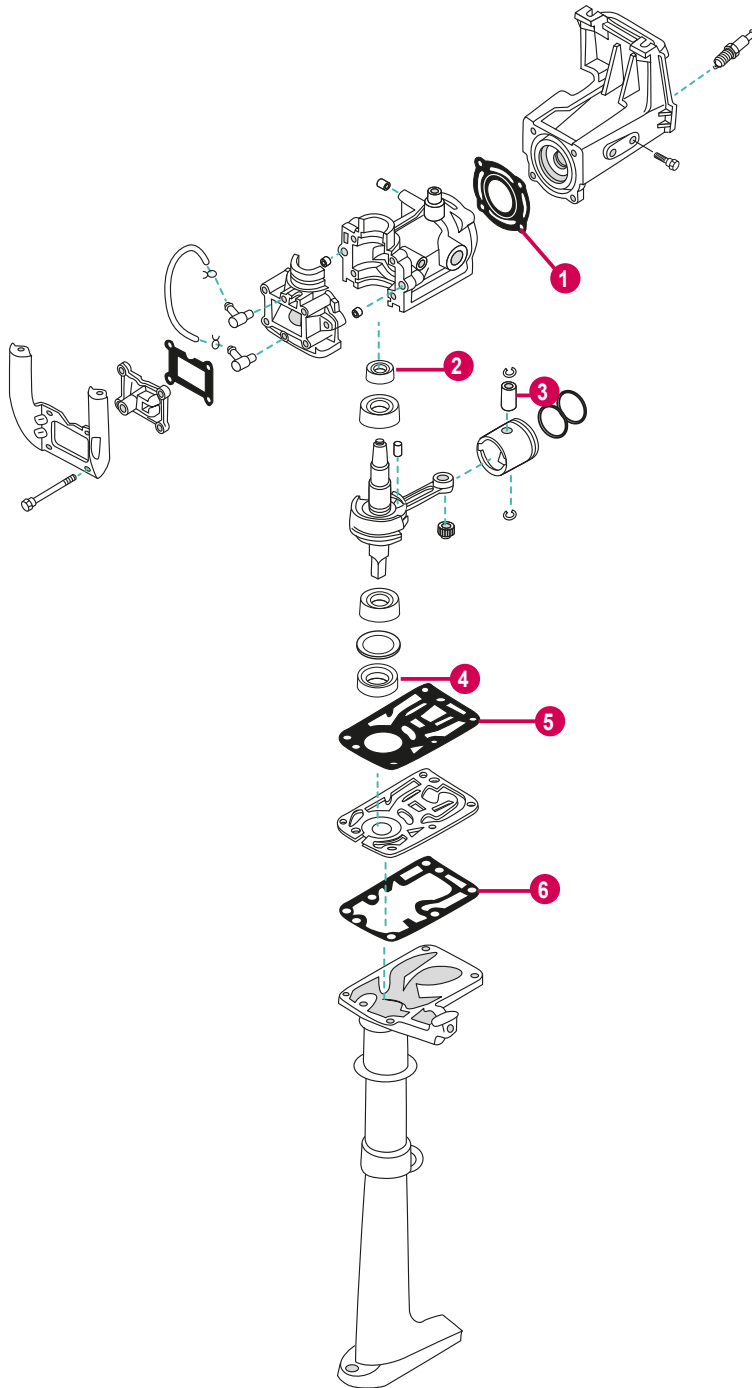

	REF	OEM			UN.
1	REC6F8-11181-A0	6F8-11181-A1	JUNTA CULATA	GASKET, CYLINDER HEAD	1
2	PAF2.6-04010001	93102-20070	RETÉN DE ACEITE	OIL SEAL	1
3	REC646-11633-00	646-11633-00	PIN, PISTÓN	PIN, PISTON	1
4	REC93102-15M32	93102-15M32	RETÉN DE ACEITE	OIL SEAL	1
5	REC6A1-14613-A0	6A1-14613-A0	JUNTA TUBO DE ESCAPE	GASKET, EXHAUST PIPE	1
6	REC646-14623-A1	646-14623-A1	JUNTA	GASKET	1

YAMAHA

RECMAR®

987

2T
STROKES

4ACMH • 4A • 4AS • 4MSH • 4KZ • 4AC • 5C • 5CS • 5ACMH

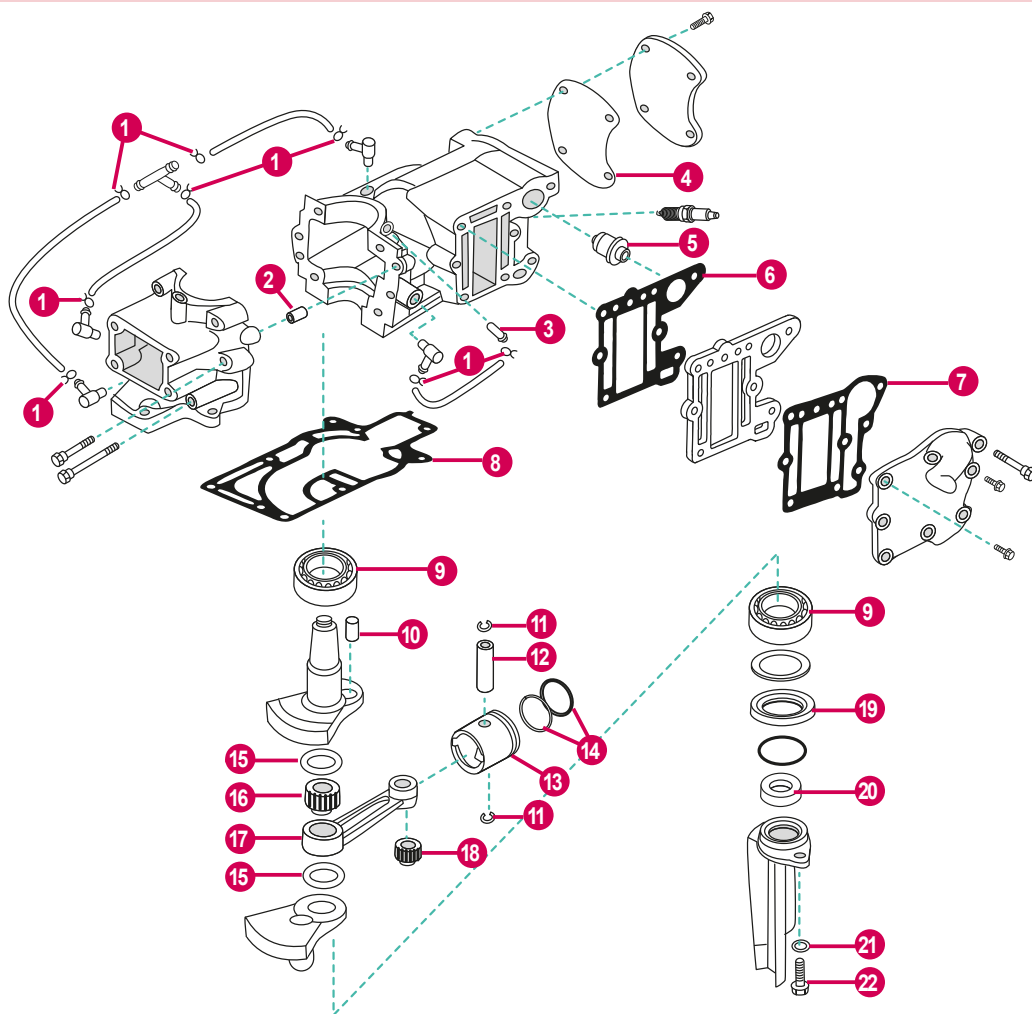

	REF	OEM		UN.	
1	PAHT-2.5X60	90467-06016	CLIP ABRAZADERA	CLIP	8
2	REC93606-12019	93606-12019	PIN CENTRADOR	HOLLOW PIN	2
3	REC624-14485-00	624-14485-00	PIPA DE AGUA	PIPE, WATER	1
4	REC6E0-11193-A1	6E0-11193-A1	JUNTA TAPA	GASKET, COVER	1
5	REC6E5-12411-02	6E5-12411-01	TERMOSTATO	THERMOSTAT	1
6	REC6E0-41112-A1	6E0-41112-A1	JUNTA DE ESCAPE	EXHAUST GASKET	1
7	REC6E0-41114-A1	6E0-41114-A1	JUNTA EXTERIOR, TAPA DE ESCAPE	GASKET, EXHAUST OUTER COVER	1
8	REC6E0-45113-A1	6E0-45113-A1	JUNTA BASE MOTOR	GASKET ENGINE	1
9	REC93306-204U0	93306-204U0	RODAMIENTO	BEARING	2
10	REC6G1-11681-00	6G1-11681-00	PIN DE CIGÜEÑAL	PIN, CRANK	1
11	REC93450-13022	93450-13022	CIRCLIP	CIRCLIP	2
12	REC6G1-11633-00	6G1-11633-00	PIN, PISTÓN	PIN, PISTON	1
13	REC6E0-11631-00-98K	6E0-11631-00-98	PISTON	PISTON STD	1
14	REC6G1-11610-00	6G1-11610-00	KIT SEGMENTOS DE PISTÓN	PISTON RING KIT	1
	REC6J1-11610-00	6J1-11610-00	KIT SEGMENTOS DE PISTÓN 5C	PISTON RING KIT 5C	1
15	REC90209-18112	90209-18112	ARANDELA	WASHER	2
16	REC93310-418V1	93310-418V1	COJINETE DE BIELA	BEARING, CONNECTING ROD	1
17	REC6E0-11651-01	6E0-11651-01	COJINETE DE BIELA	BEARING, CONNECTING ROD	1
18	REC93310-112V0	93310-112V0	RODAMIENTO	BEARING	1
19	REC93101-20M29	93101-20M29	RETÉN DE ACEITE	OIL SEAL	1
20	REC93101-10M25	93101-10M25	RETÉN DE ACEITE	OIL SEAL	1
21	PAGB/T96-6	92995-06600	ARANDELA	WASHER	1
22	PAGB/T5783-M6X16	97095-06016	TORNILLO	BOLT	1

2T
STROKES

6CMH • 6CWH • 6MSH • 6DMH • 6MH • 6D
8CMH • 8CWH • 8MSH • 8MH • 8D

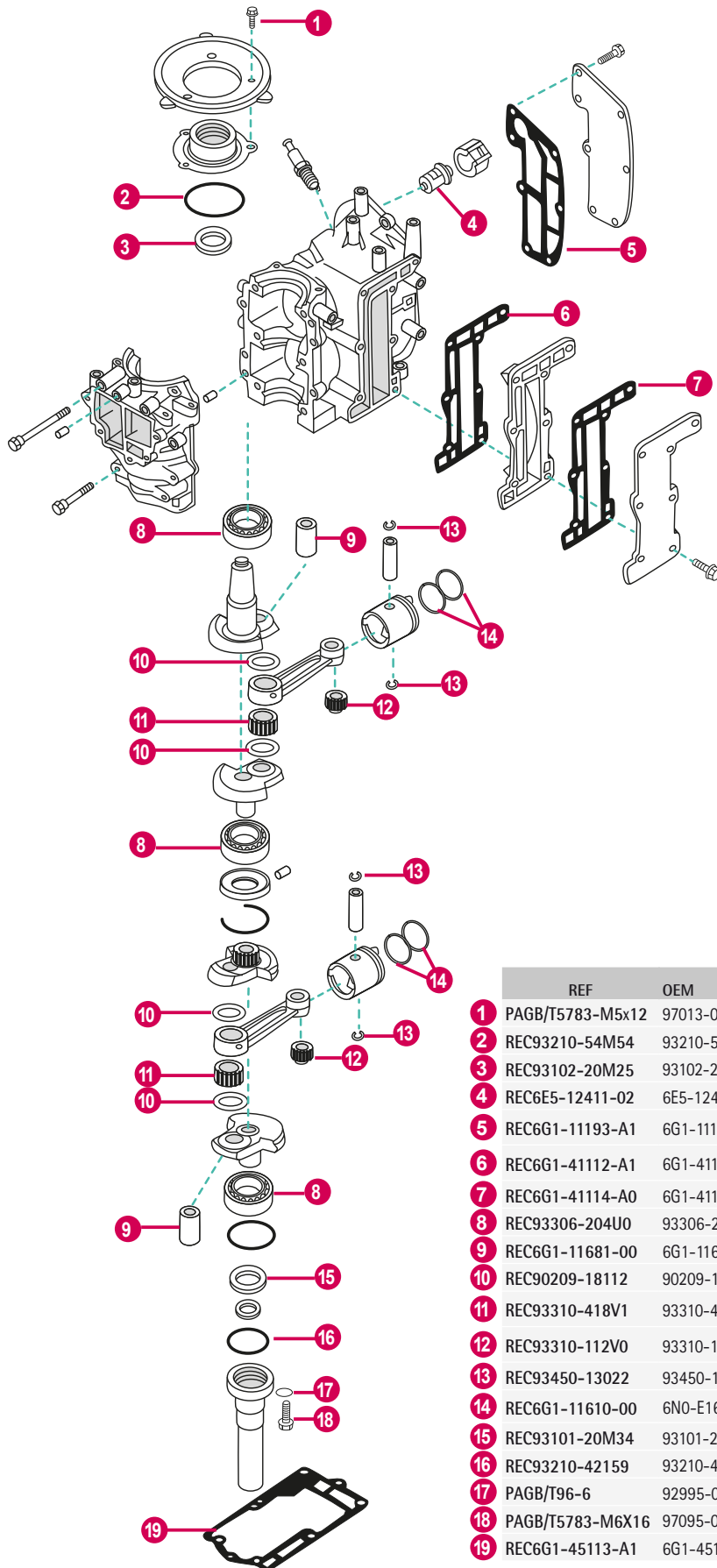

REF	OEM		UN.
1	PAGB/T5783-M5x12	97013-06016	TORNILLO BOLT 3
2	REC93210-54M54	93210-54M54	TÓRICA O-RING 3
3	REC93102-20M25	93102-20M25	RETÉN DE ACEITE OIL SEAL 1
4	REC6E5-12411-02	6E5-12411-01	TERMOSTATO THERMOSTAT 1
5	REC6G1-11193-A1	6G1-11193-A1	JUNTA TAPA TERMOSTATO GASKET, THERMOSTAT COVER 1
6	REC6G1-41112-A1	6G1-41112-A1	JUNTA EXTERIOR, TAPA DE ESCAPE GASKET, EXHAUST OUTER COVER 1
7	REC6G1-41114-A0	6G1-41114-A0	JUNTA DE ESCAPE EXHAUST GASKET 1
8	REC93306-204U0	93306-204U0	RODAMIENTO BALL BEARING 3
9	REC6G1-11681-00	6G1-11681-00	PIN PIN 2
10	REC90209-18112	90209-18112	ARANDELA WASHER 4
11	REC93310-418V1	93310-418V1	COJINETE DE BIELA BEARING, CONNECTING ROD 2
12	REC93310-112V0	93310-112V0	COJINETE DE BIELA BEARING, CONNECTING ROD 2
13	REC93450-13022	93450-13022	CIRCLIP CIRCLIP 4
14	REC6G1-11610-00	6N0-E1603-00	KIT SEGMENTOS DE PISTÓN PISTON RING SET 2
15	REC93101-20M34	93101-20M34	RETÉN DE ACEITE OIL SEAL 1
16	REC93210-42159	93210-42159	TÓRICA O-RING 1
17	PAGB/T96-6	92995-06600	ARANDELA WASHER 1
18	PAGB/T5783-M6X16	97095-06016	TORNILLO BOLT 1
19	REC6G1-45113-A1	6G1-45113-A1	JUNTA BASE MOTOR GASKET ENGINE 1

YAMAHA

RECMAR®

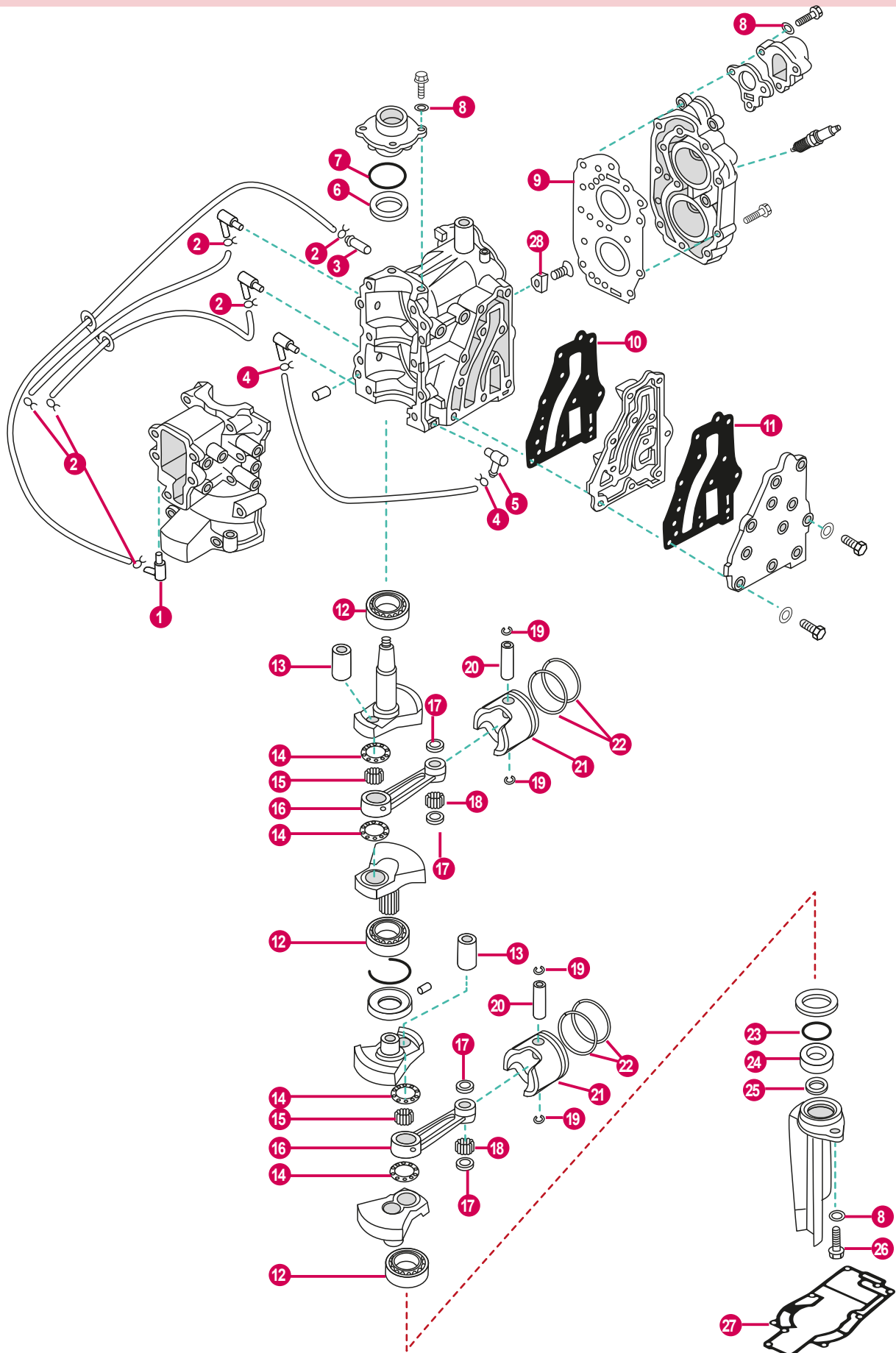

	REF	OEM			UN.
1	REC650-11370-00	650-11370-01	NIPLE DE MANGUERA	NIPPLE	1
2	PAHT-2.5X60	90467-06016	PRESILLA	CLIP	6
3	REC624-14485-00	624-14485-00	PIPA DE AGUA	PIPE, WATER	1
4	PAF4-04000030	90467-09M09	PRESILLA	CLIP	2
5	PAF15-04000005	676-11372-00	NIPLE DE MANGUERA	NIPPLE	1
6	REC93102-20M25	93102-20M25	RETÉN DE ACEITE	OIL SEAL	1
7	REC93210-42159	93210-42159	TÓRICA	O-RING	1
8	PAGB/T96-6	92995-06600	ARANDELA	WASHER	6
9	REC677-11181-A0	677-11181-A1	JUNTA CULATA	GASKET, CYLINDER HEAD	1
10	REC677-41112-A0	677-41112-A1	JUNTA DE ESCAPE	EXHAUST GASKET	1
11	REC677-41112-A0	677-41114-A1	JUNTA EXTERIOR, TAPA DE ESCAPE	GASKET, EXHAUST OUTER COVER	1
12	REC93306-204U0	93306-240U0	RODAMIENTO	BALL BEARING	3
13	REC6G1-11681-00	6G1-11681-00	PIN	PIN	2
14	REC90209-18112	90209-18112	ARANDELA	WASHER	4
15	REC93310-418U0	93310-418U0	COJINETE DE BIELA	BEARING, CONNECTING ROD	2
16	REC6E0-11651-01	6E0-11651-01	BIELA	CONNECTING ROD	2
17	REC90201-12565	90201-12565	ARANDELA PLANA	WASHER PLATE	4
18	REC93602-14118	93602-14118	COJINETE DE BIELA	BEARING, CONNECTING ROD	56
19	REC93450-13022	93450-13022	CIRCLIP	CIRCLIP	4
20	REC6G1-11633-00	6G1-11633-00	PIN, PISTÓN	PIN, PISTON	2
	REC677-11631-00K	677-11631-00-97	PISTÓN STD	PISTON STD	
21	REC677-11635-00K	677-11635-00	PISTÓN 0.25mm O/S	PISTON 0.25mm O/S	2
	REC677-11636-00K	677-11636-00	PISTÓN 0.50mm O/S	PISTON 0.50mm O/S	
22	REC647-11610-00	647-11610-00	KIT SEGMENTOS STD	PISTON RING SET STD	2
	REC647-11610-10	647-11610-10	KIT SEGMENTOS 0.25mm O/S	PISTON RING SET 0.25mm O/S	
23	REC93210-42M70	93210-42M70	TÓRICA	O-RING	1
24	REC93101-20M29	93101-20M29	RETÉN DE ACEITE	OIL SEAL	1
25	REC93101-14M01	93101-14M01	RETÉN DE ACEITE	OIL SEAL	1
26	PAGB/T5783-M6X16	97095-06016	PERNO	STUD	2
27	REC677-45113-A0	677-45113-A0	JUNTA BASE MOTOR	GASKET ENGINE	1
28	REC676-11325-00AL	676-11325-00	ÁNODO	ANODE	1



2T
STROKES

9.9F/FM/FEM/MHV • 9.9FMH/MSH • 13.5AMH • 15F/FEM/FM/MH/MSH • 15FW/MHH

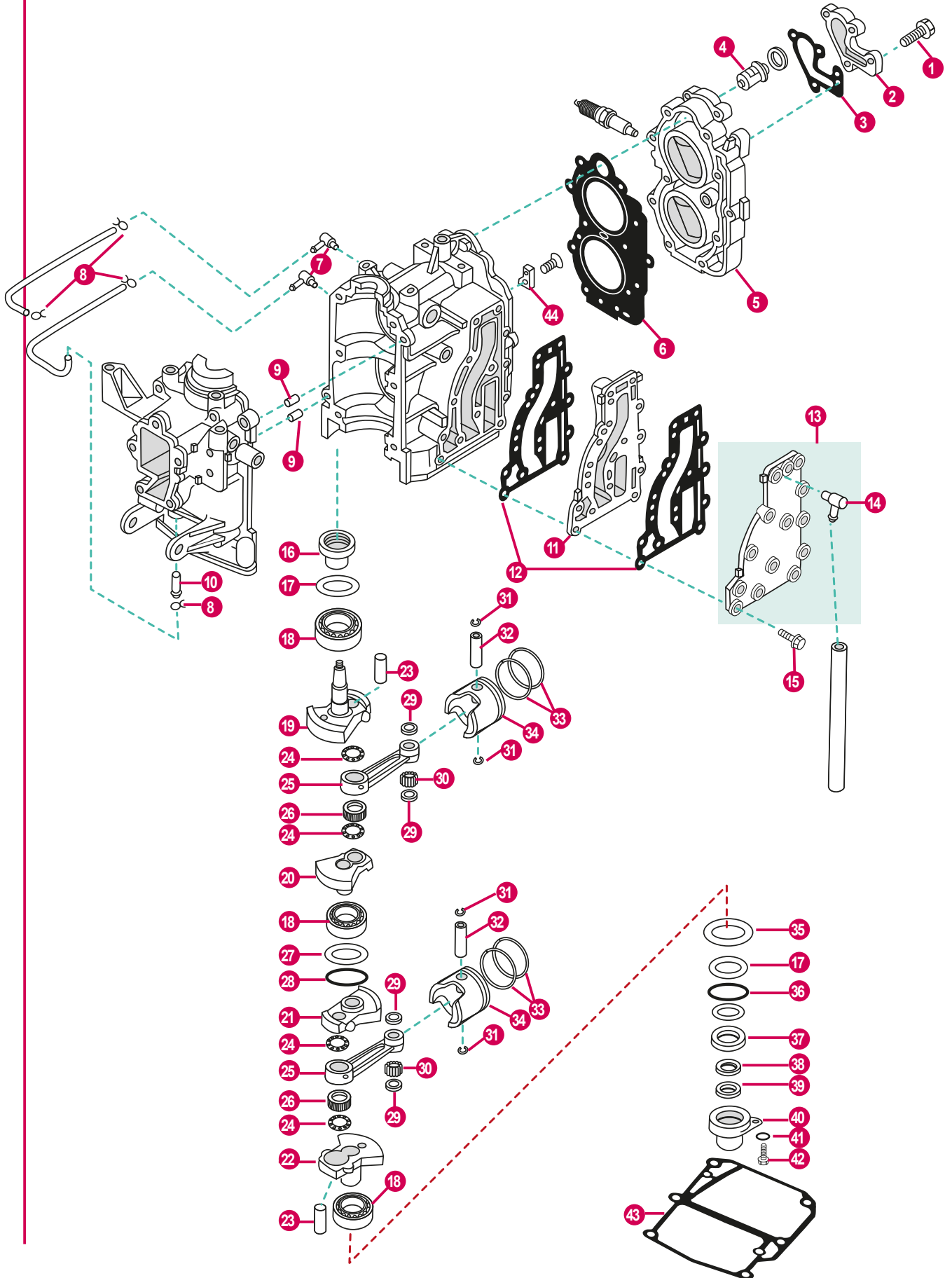

YAMAHA

RECMOIR®

	REF	OEM			UN.
1	PAGB/T5783-M6X20	90119-06MA2	TORNILLO	BOLT	4
2	REC682-12413-00-1S	682-12413-00-1S	TAPA TERMOSTATO	COVER, THERMOSTAT	1
3	REC682-12414-A1	682-12414-A1	JUNTA TAPA TERMOSTATO	GASKET, THERMOSTAT COVER	1
4	REC6E5-12411-30	6E5-12411-30	TERMOSTATO	THERMOSTAT	1
5	REC6E7-11111-01-1S	6E7-11111-01-1S	CULATA	HEAD CYLINDER	1
6	REC63V-11181-A1	63V-11181-A2	JUNTA CULATA	GASKET, CYLINDER HEAD	1
7	REC650-14485-03	650-14485-03	NIPLE DE MANGUERA	NIPPLE	2
8	PAHT-2.5X60	90467-06016	BRIDA	CLAMP	4
9	REC93606-12019	93606-12019	PIN CENTRADOR	HOLLOW PIN	2
10	REC624-14485-00	624-14485-00	PIPA DE AGUA	PIPE, WATER	1
11	REC63V-41111-00-1S	63V-41111-00-1S	PLACA ESCAPE	INNER COVER, EXHAUST	1
12	REC63V-41112-A0	63V-41112-A0	JUNTA TAPA	GASKET, COVER	2
13	REC63V-41113-00-1S	63V-41113-00-1S	CUBIERTA DE ESCAPE	EXHAUST COVER	1
14	PAF15-04000005	676-11372-00	NIPLE DE MANGUERA	NIPPLE	1
15	PAGB/T5783-M6X30	90119-06M04	TORNILLO	BOLT	13
16	REC93110-23M00	93110-23M00	RETÉN DE ACEITE	OIL SEAL	1
17	REC63V-11445-00	63V-11445-00	ESPACIADOR	COLLAR	2
18	REC93306-205U7	93306-205U7	RODAMIENTO	BALL BEARING	3
19	REC63V-11412-00	63V-11412-00	CIGÜEÑAL 1	CRANK 1	1
20	REC63V-11422-00	63V-11422-00	CIGÜEÑAL 2	CRANK 2	1
21	REC63V-11432-00	63V-11432-00	CIGÜEÑAL 3	CRANK 3	1
22	REC63V-11442-00	63V-11442-00	CIGÜEÑAL 4	CRANK 4	1
23	REC682-11681-00	682-11681-00	PIN	PIN	2
24	REC90209-20159	90209-20M23	ARANDELA	WASHER	4
25	REC650-11651-04	650-11651-00	BIELA	CONNECTING ROD	2
26	REC93310-620V5	93310-620V5	COJINETE DE BIELA	BEARING, CONNECTING ROD	2
27	REC63V-11515-02	63V-11515-02	ARILLO	SEAL LABYRINTH	1
28	REC93440-52009	93440-52008	CLIP	CLIP	1
29	REC90201-14377	9020-14377	ARANDELA	WASHER	4
30	REC93602-14104	93602-14104	AGUJAS DE RODAMIENTO	PIN DOWEL	50
31	REC93450-15023	93450-15023	CIRCLIP	CIRCLIP	4
32	REC634-11633-00	634-11633-00	PIN, PISTÓN	PIN, PISTON	2
	REC682-11610-01	682-11610-01	KIT SEGMENTOS STD	PISTON RING SET STD	
33	REC682-11610-11	682-11610-11	KIT SEGMENTOS 0.25mm O/S	PISTON RING SET 0.25mm O/S	2
	REC682-11610-21	682-11610-21	KIT SEGMENTOS 0.50mm O/S	PISTON RING SET 0.50mm O/S	
	REC6E7-11631-00K	6E7-11631-00-97	PISTÓN STD	PISTON STD	
34	REC6E7-11635-00K	6E7-11635-00	PISTÓN 0.25mm O/S	PISTON 0.25mm O/S	2
	REC6E7-11636-00K	6E7-11636-00	PISTÓN 0.50mm O/S	PISTON 0.50mm O/S	
35	REC90201-46M29	90201-46M29	ARANDELA	WASHER	1
36	REC93210-46M16	93210-46M16	TÓRICA	O-RING	1
37	REC93102-25M48	93102-25M48	RETÉN DE ACEITE	OIL SEAL	1
38	REC93101-25018	93101-250-18	RETÉN DE ACEITE	OIL SEAL	1
39	REC93101-13018	93101-13018	RETÉN DE ACEITE	OIL SEAL	2
40	REC63V-15396-01-CA	63V-15396-01-CA	CUERPO DEL RETÉN	SHELL, OIL SEAL	1
41	PAGB/T97.1-8	92995-06600	ARANDELA	WASHER	1
42	PAGB/T5783-M6X16	97095-06016	TORNILLO	BOLT	1
43	REC63V-45113-A1	63V-45113-A1	JUNTA BASE MOTOR	GASKET ENGINE	1
44	REC682-11325-00AL	682-11325-00	ÁNODO	ANODE	1

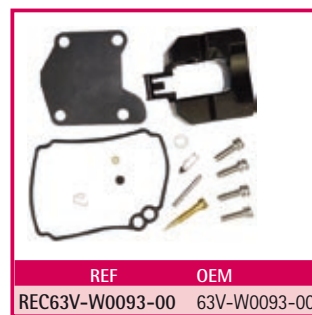

REF	OEM
REC63V-W0093-00	63V-W0093-00



REF	OEM
REC63V-W0001-00	63V-W0001-00

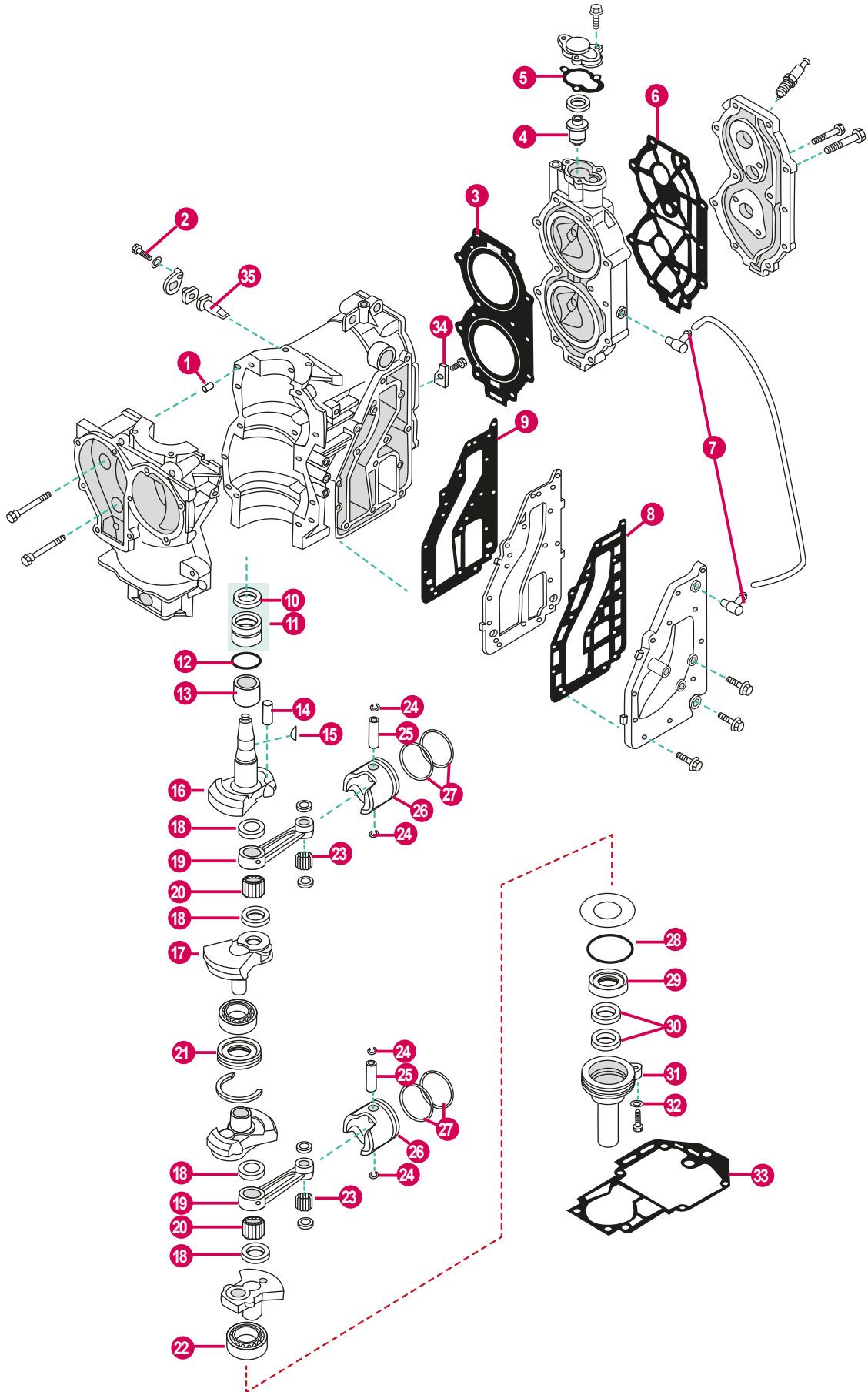

	REF	OEM			UN.
1	REC93606-12019	93606-12019	PIN CENTRADOR	HOLLOW PIN	2
2	PAGB/T5783-M5X12	97013-06016	TORNILLO	BOLT	1
3	REC61N-11181-00	61N-11181-A1	JUNTA CULATA	GASKET, CYLINDER HEAD	1
4	REC6E5-12411-02	6E5-12411-01	TERMOSTATO	THERMOSTAT	1
5	REC655-12414-A1	655-12414-A1	JUNTA TAPA TERMOSTATO	GASKET, THERMOSTAT COVER	1
6	REC61T-11193-A0	61T-11193-A1	JUNTA TAPA DE CULATA	GASKET, CYLINDER HEAD COVER	1
7	PAF15-04000005	676-11372-00	NIPLE DE MANGUERA	NIPPLE	2
8	REC6K8-41124-A1	6K8-41124-A1	JUNTA EXTERIOR, TAPA DE ESCAPE	GASKET, EXHAUST OUTER COVER	1
9	REC6K8-41122-A1	6K8-41122-A1	JUNTA DE ESCAPE	EXHAUST GASKET	1
10	REC93102-32M07	93102-32M07	RETÉN DE ACEITE	OIL SEAL	1
11	REC93399-99951	93399-99951	RODAMIENTO	BEARING	1
12	REC93210-46M16	93210-46M16	TÓRICA	O-RING	1
13	REC90387-32002	90387-32002	COLLAR	COLLAR	1
14	REC689-11681-00	689-11681-01	PIN	PIN	2
15	REC90280-05049	90280-05049	CHAVETA	KEY WOODRUFF	1
16	REC6G0-11412-00	69P-11412-00	CIGÜEÑAL 1	CRANK 1	1
17	REC6G0-11422-00	69P-11422-00	CIGÜEÑAL 2	CRANK 2	1
18	REC90209-24M03	90209-24M03	ARANDELA	WASHER	4
19	REC689-11651-00	689-11651-00	BIELA	ROD CONNECTING	2
20	REC93310-624U5	93310-62406	COJINETE DE BIELA	BEARING, CONNECTING ROD	2
21	REC61N-11515-00	61N-11515-00	ARO	SEAL, LABYRINTH	1
22	REC93306-305U3	93306-305U3	RODAMIENTO	BEARING	1
23	REC93602-20M02	93602-20M02	AGUJA PASADOR	NEEDLE PIN	68
24	REC688-11634-00	688-11634-00	CIRCLIP	CIRCLIP	4
25	REC689-11633-00	689-11633-00	PIN, PISTÓN	PIN, PISTON	2
	REC61N-11631-00K	61N-11631-00-95	PISTÓN STD	PISTON STD	2
26	REC61N-11635-00K	61N-11635-00	PISTÓN 0.25mm O/S	PISTON 0.25mm O/S	2
	REC61N-11636-00K	61N-11636-00	PISTÓN 0.50mm O/S	PISTON 0.50mm O/S	2
	REC61N-11603-00	61N-11603-00	KIT SEGMENTOS STD	PISTON RING SET STD	
27	REC61N-11604-00	61N-11604-00	KIT SEGMENTOS 0.25mm O/S	PISTON RING SET 0.25mm O/S	2
	REC61N-11605-00	61N-11605-00	KIT SEGMENTOS 0.50mm O/S	PISTON RING SET 0.50mm O/S	
28	REC93210-57M09	93210-58M21	TÓRICA	O-RING	1
29	REC93102-25008	93102-25008	RETÉN DE ACEITE	OIL SEAL	1
30	REC93101-16001	93101-16001	RETÉN DE ACEITE	OIL SEAL	2
31	REC689-15396-01-CA	689-15396-01-5B	CUERPO DEL RETÉN	SHELL, OIL SEAL	1
32	PAGB/T97.1-8	92995-06600	ARANDELA	WASHER	1
33	REC61T-45113-A0	689-45113-A1	JUNTA BASE MOTOR	GASKET ENGINE	1
34	REC689-11325-00AL	689-11325-00	ÁNODO	ANODE	1
35	REC6J8-11325-00AL	6J8-11325-00	ÁNODO	ANODE	1



REF	OEM
REC61N-W0093-00	61N-W0093-00

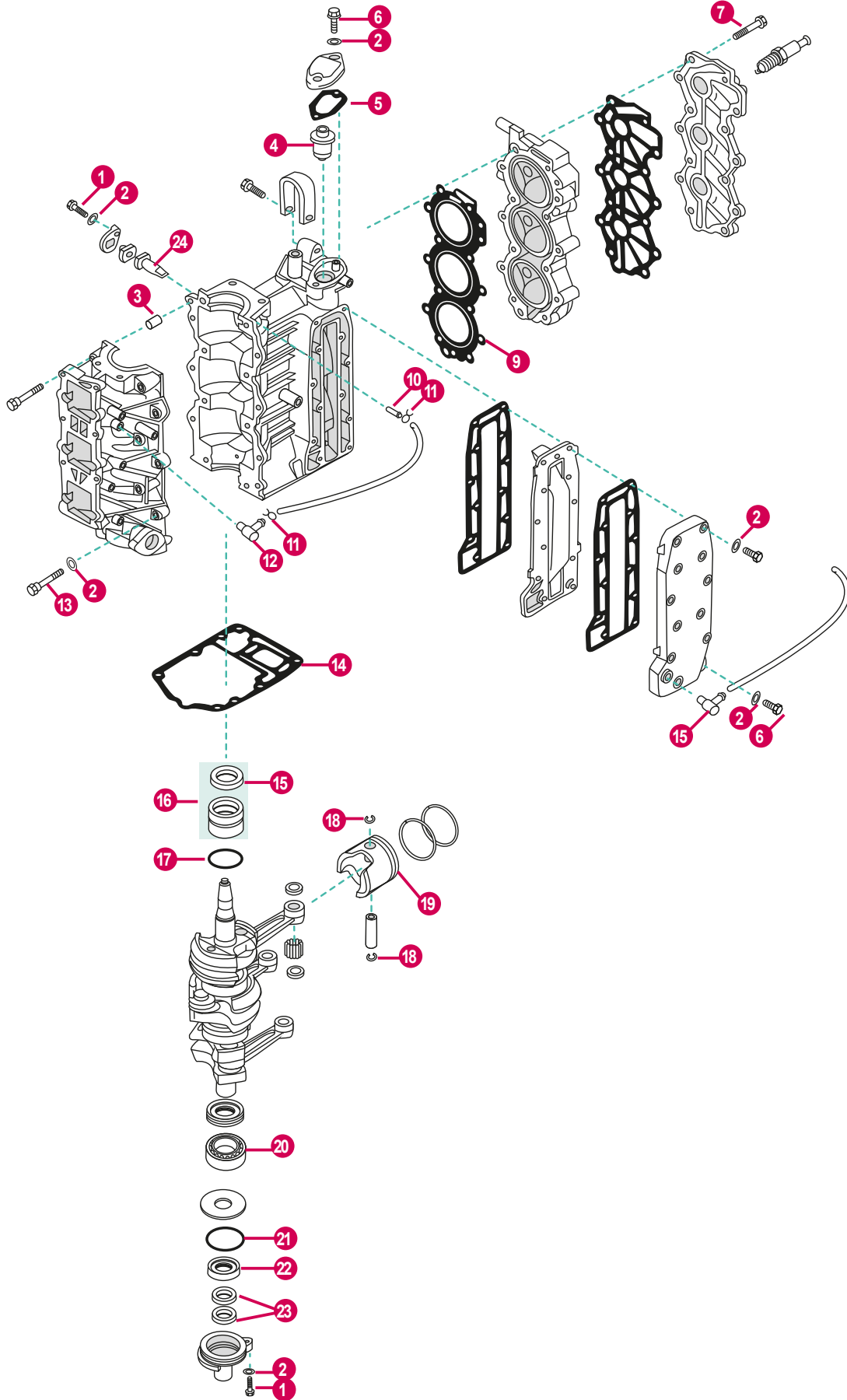

	REF	OEM			UN.
1	PAGB/T5783-M6X16	97095-06016	TORNILLO	BOLT	4
2	PAGB/T96-6	92990-06600	ARANDELA PLANA	FLAT WASHER	24
3	REC93606-12019	93606-12019	PIN CENTRADOR	HOLLOW PIN	2
4	REC6E5-12411-02	6E5-12411-01	TERMOSTATO	THERMOSTAT	1
5	REC61A-12414-A0	61A-12414-A0	JUNTA TAPA TERMOSTATO	GASKET, THERMOSTAT COVER	1
6	PAGB/T5782-M6X25	97095-06025	TORNILLO	BOLT	3
7	REC90119-08M21	90119-08M21	TORNILLO CON ARANDELA	BOLT, FLANGE	14
8	REC6J8-11181-A2	6J8-11181-A1	JUNTA CULATA	GASKET, CYLINDER HEAD	1
9	REC624-14485-00	624-14485-00	PIPA DE AGUA	PIPE, WATER	1
10	PAHT-2.5X60	90467-06016	PRESILLA	CLAMP	2
11	REC650-11370-00	650-11370-00	NIPLE DE MANGUERA	NIPPLE	1
12	PAGB/T5783-M6X30	970-95-06030	TORNILLO	BOLT	6
13	PAF15-04000005	676-11372-00	NIPLE DE MANGUERA	NIPPLE	1
14	REC6J8-45113-00	6J8-45113-A0	JUNTA BASE MOTOR	GASKET ENGINE	1
15	REC93102-26M27	93102-26M27	RETÉN DE ACEITE	OIL SEAL	1
16	REC93311-632U7	93311-632U7	COJINETE DE RODILLOS	BEARING CYL	1
17	REC93210-42159	93210-42159	TÓRICA	O-RING	1
18	PAF25-05020106	93450-17129	CIRCLIP	CIRCLIP	6
19	REC6J8-11631-02	6J8-11631-02-97	PISTÓN STD	PISTO STD	3
20	REC93306-305U3	93306-305U3	RODAMIENTO	BALL BEARING	1
21	PAF15-06080003	93210-56M80	TÓRICA	O-RING	1
22	REC93101-25M35	93101-25M28	RETÉN DE ACEITE	OIL SEAL	1
23	REC93104-16M01	93104-16M04	RETÉN DE ACEITE	OIL SEAL	2
24	REC6J8-11325-00AL	6J8-11325-00	ÁNODO	ANODE	1

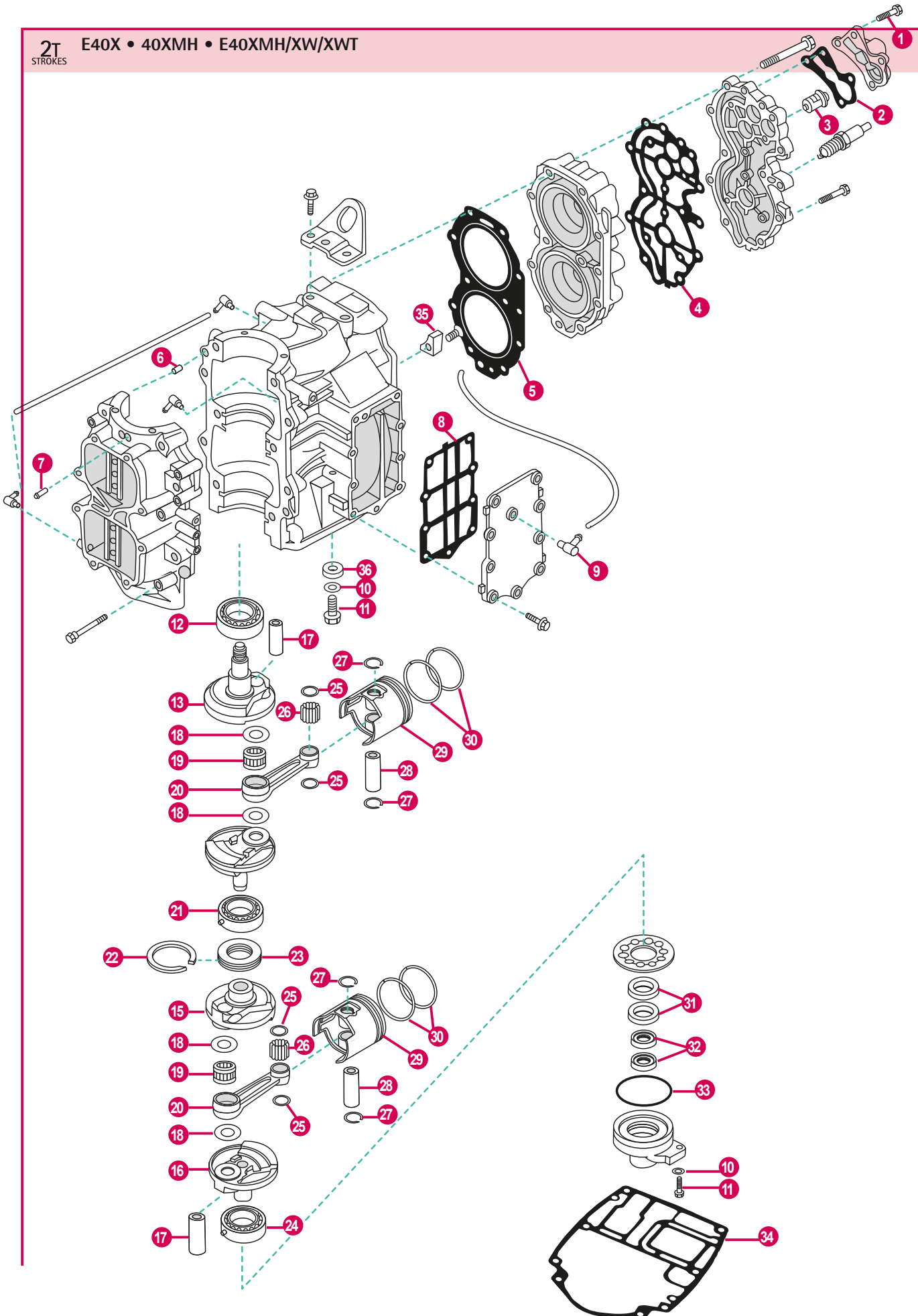

	REF	OEM			UN.
1	PAGB/T5782-M6X35	90119-06MA5	TORNILLO	BOLT WITH WASHER	4
2	REC676-12414-A0	676-12414-A0	JUNTA TAPA TERMOSTATO	GASKET, THERMOSTAT COVER	1
3	REC6E5-12411-02	6E5-12411-01	TERMOSTATO	THERMOSTAT	1
4	REC66T-11193-A0	66T-11193-A0	JUNTA DE CULATÍN	HEAD VOER GASKET	1
5	REC66T-11181-00	66T-11181-A2	JUNTA CULATA	GASKET, CYLINDER HEAD	1
6	PAF15-00000014	93608-12063	PIN CENTRADOR	HOLLOW PIN	2
7	REC624-14485-00	624-14485-00	PIPA DE AGUA	PIPE, WATER	1
8	REC66T-41114-A0	66T-41114-A0	JUNTA TAPA	GASKET, COVER	1
9	PAF15-04000005	676-11372-00	NIPLE DE MANGUERA	NIPPLE	1
10	PAGB/T97.1-8	92995-06600	ARANDELA	WASHER	2
11	PAGB/T5783-M6X20	97095-06020	TORNILLO	BOLT	2
12	REC93306-307U0	93306-307U0	RODAMIENTO	BEARING	1
13	REC66T-11412-00	66T-11412-00	CIGÜEÑAL 1	CRANK 1	1
15	REC66T-11432-00	66T-11432-00	CIGÜEÑAL 3	CRANK 3	1
16	REC66T-11442-00	66T-11442-00	CIGÜEÑAL 4	CRANK 4	1
17	REC66T-11681-00	66T-11681-00	PIN	PIN	2
18	REC90209-27M07	90209-27M07	ARANDELA	WASHER	4
19	REC93310-727U0	93310-727U0	RODAMIENTO	BEARING	2
20	REC6F5-11651-00	6F5-11651-00	BIELA	ROD CONNECTING	2
21	REC93332-000UE	93332-000UE	RODAMIENTO	BEARING	1
22	REC93440-68M03	93440-68M03	CIRCLIP	CIRCLIP	1
23	REC6F5-11515-00	6F5-11515-00	ARILLO	SEAL, LABERYNTH	1
24	REC93306-306V5	9306-306V5	RODAMIENTO	BEARING	1
25	REC90201-20417	90201-20417	ARANDELA	WASHER PLATE	4
26	REC93603-21111	93603-21111	AGUJAS DE RODAMIENTO	PIN, DOWEL	56
27	REC663-11634-00	633-11634-00	JUNTA	CLIP	4
28	REC6F5-11633-00	6F5-11633-00	PIN, PISTÓN	PIN, PISTON	2
	REC66T-11631-01K	66T-11631-01-93	PISTÓN STD	PISTON STD	
29	REC66T-11635-01K	66T-11635-01	PISTÓN 0.25mm O/S	PISTON 0.25mm O/S	2
	REC66T-11636-01K	66T-11636-01	PISTÓN 0.50mm O/S	PISTON 0.50mm O/S	
	REC66T-11603-00	66T-11603-00	KIT SEGMENTOS STD	PISTON RING SET STD	
30	REC66T-11604-00	66T-11604-00	KIT SEGMENTOS 0.25mm O/S	PISTON RING SET 0.25mm O/S	2
	REC66T-11605-00	66T-11605-00	KIT SEGMENTOS 0.50mm O/S	PISTON RING SET 0.50mm O/S	
31	REC93102-30M56	93102-30M56	RETÉN DE ACEITE	OIL SEAL	2
32	REC93101-16001	93101-16001	RETÉN DE ACEITE	OIL SEAL	2
33	REC93210-65M50	93210-65M50	TÓRICA	O-RING	1
34	REC66T-45113-A0	66T-45113-A00	JUNTA BASE MOTOR	GASKET ENGINE	1
35	REC676-11325-00AL	6J8-11325-00	ÁNODO	ANODE	1
36	REC676-45251-00AL	6J8-11325-00	ÁNODO	ANODE	1



REF	OEM
REC66T-W0093-01	66T-W0093-01



REF	OEM
REC66T-W0001-01	66T-W0001-01

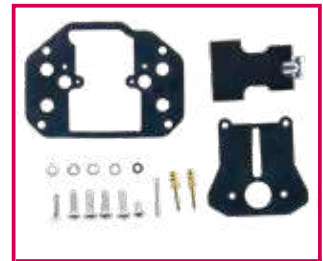
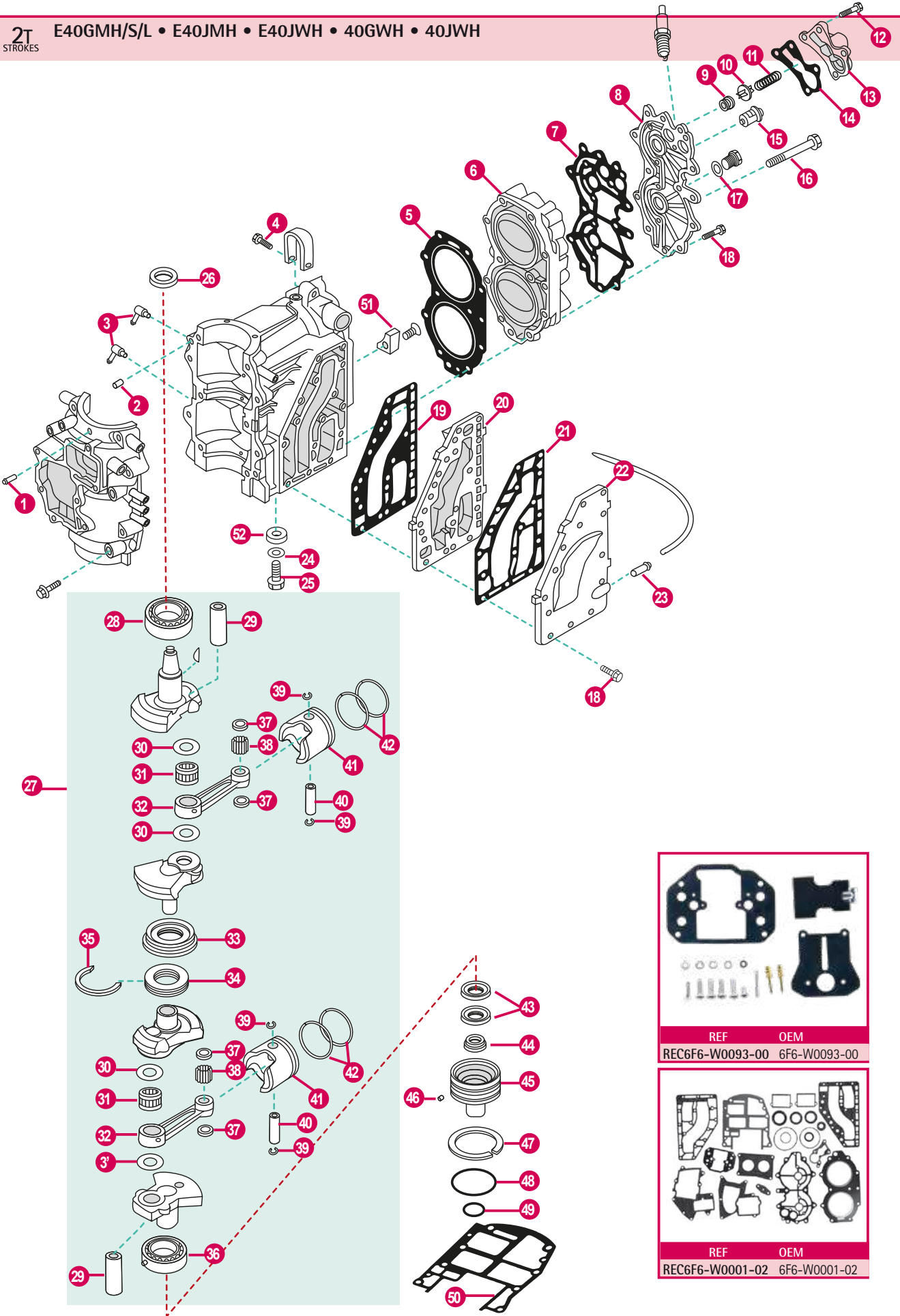

REF	OEM
REC6F6-W0093-00	6F6-W0093-00

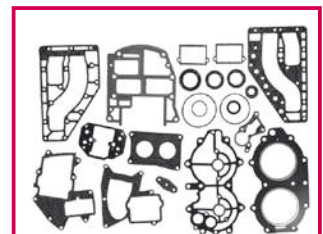

REF	OEM
REC6F6-W0001-02	6F6-W0001-02

	REF	OEM		UN.	
1	PAT15-04010202	624-14485-00	PIPA DE AGUA	PIPE, WATER	1
2	PAF25-00000014	93608-12063	PIN CENTRADOR	HOLLOW PIN	2
3	REC650-11370-00	650-11370-01	NIPLE DE MANGUERA	NIPPLE	2
4	PAGB/T5783-M8X35	90101-08001	TORNILLO	BOLT	1
5	REC6F5-11181-A2	6F5-11181-A1	JUNTA CULATA	GASKET, CYLINDER HEAD	1
6	REC6F6-11111-00-1S	6F6-11111-00-1S	CULATA DE CILINDRO	CYLINDER HEAD	1
7	REC6F6-11193-A1	6F6-11193-A1	JUNTA TAPA	GASKET, COVER	1
8	REC6F6-11191-00-1S	6F6-11191-00-1S	TAPA CULATA DE CILINDRO	HEAD CYLINDER COVER	1
9	REC90480-18065	90480-18065	TAPÓN	PLUG	1
10	REC663-12416-00	663-12416-00	VÁLVULA DE PRESIÓN	VALVE, PRESS CONTROL	1
11	REC90501-14M02	90501-14M02	RESORTE DE COMPRESIÓN	SPRING COMPRESSION	1
12	PAGB/T5783-M6X30	90119-06MA4	TORNILLO CON ARANDELA	BOLT, FLANGE	4
13	REC6E9-12413-00-1S	6E9-12413-00-1S	TAPA TERMOSTATO	COVER, THERMOSTAT	1
14	REC6E9-12414-A1	6E9-12414-A1	JUNTA TAPA TERMOSTATO	GASKET, THERMOSTAT COVER	1
15	REC6F5-12411-03	6F5-12411-02	TERMOSTATO	THERMOSTAT	1
16	PAF15-04000003	90430-14115	JUNTA	GASKET	1
17	PAGB/T5783-M6X25	90119-08MA5	TORNILLO	BOLT	11
18	PAGB/T5783-M6X25	90119-06MA3	TORNILLO CON ARANDELA	BOLT, FLANGE	20
19	REC6F5-41112-A0	6F5-41112-A0	JUNTA DE ESCAPE	EXHAUST GASKET	1
20	REC6F5-41111-01-1S	6F5-41111-01-1S	CUBIERTA INTERIOR DE ESCAPE	INNER EXHAUST COVER	1
21	REC6F5-41114-A0	6F5-41114-A0	JUNTA EXTERIOR, TAPA DE ESCAPE	GASKET, EXHAUST OUTER COVER	1
22	REC6F5-41113-A0-1S	6F5-41113-01-1S	CUBIERTA EXTERIOR DE ESCAPE	OUTTER EXHAUST COVER	1
23	PAF4-04010102	650-24378-00	PIPA DE AGUA	PIPE, WATER	1
24	PAGB/T96-6	92995-06600	ARANDELA	WASHER	1
25	PAGB/T5783-M6X16	97095-06016	TORNILLO	BOLT	1
26	REC93102-35M18	93102-35M18	RETÉN DE ACEITE	OIL SEAL	1
27	REC6F6-11400-02	6F6-11400-01	CIGÜEÑAL COMPLETO	CRANK ASSY	1
28	REC93306-307U0	93306-307U0	RODAMIENTO	BALL BEARING	1
29	REC6F5-11681-00	6F5-11681-00	PIN	PIN	2
30	REC90209-27M07	90209-27M07	ARANDELA DE SEPARACIÓN	WASHER	14
31	REC93310-727V7	93310-727V7	COJINETE DE BIELA	BEARING, CONNECTING ROD	2
32	REC6F5-11651-00	6F5-11651-00	BIELA	ROD, CONNECTING	2
33	REC93332-000UE	93332-000UE	COJINETE	BEARING	1
34	REC6F5-11515-00	6F5-11515-00	SELLO LABERINTO	LABERINTH SEAL	1
35	REC93440-68M03	93440-68M03	CIRCLIP	CIRCLIP	1
36	REC93306-306V1	93306-303V1	COJINETE	BEARING	1
37	REC90201-20417	90201-20417	ARANDELA PLANA	FLAT WASHER	4
38	REC93603-21111	93603-21111	AGUJA PASADOR	NEEDLE PIN	56
39	REC663-11634-00	663-11634-00	CIRCLIP	CIRCLIP	4
40	REC6F5-11633-00	6F5-11633-00	PIN, PISTÓN	PIN, PISTON	2
	REC6F6-11631-00K	6F6-11631-00-95	PISTÓN STD	PISTON STD	
41	REC6F6-11635-00K	6F6-11635-00	PISTÓN 0.25mm O/S	PISTON 0.25mm O/S	2
	REC6F6-11636-00K	6F6-11636-00	PISTÓN 0.50mm O/S	PISTON 0.50mm O/S	
42	REC6F5-11610-00	6F6-11610-00	KIT SEGMENTOS STD	PISTON RING SET STD	
	REC6F5-11610-20	6F6-11610-20	KIT SEGMENTOS 0.50mm O/S	PISTON RING SET 0.50mm O/S	2
43	REC93101-30M33	93101-30M33	RETÉN DE ACEITE	OIL SEAL	2
44	REC93104-16M01	93104-16M01	RETÉN DE ACEITE	OIL SEAL	1
45	REC6F5-15396-01-5B	6F5-15396-01-5B	CUERPO DEL RETÉN	SHELL, OIL SEAL	1
46	PAGB/T879.4-3X20	91690-30010	PASADOR DE RESORTE	PIN, SPRING	1
47	REC93440-68M03	93440-68M03	CIRCLIP	CIRCLIP	1
48	REC93210-65M50	93210-65M50	TÓRICA	O-RING	1
49	REC93210-22M02	93210-22M02	TÓRICA	O-RING	1
50	REC6F5-45113-A0	6F5-45113-A0	JUNTA BASE MOTOR	GASKET ENGINE	1
51	REC676-11325-00L	676-11325-00	ÁNODO	ANODE	1
52	REC676-45251-00A	676-45251-00	ÁNODO	ANODE	1

2T
STROKES

25Q/QEO · 40A/C · 40ELR · 40H/HE · 40MLHZ · 40O/OS · 40TLR · 40V/VE/VEO/VETO/VMHO · 40YETO/Z
50D/DE · 50H/HEDO/HETO/HMHD/HWHDLO/HRDO · 50MTO

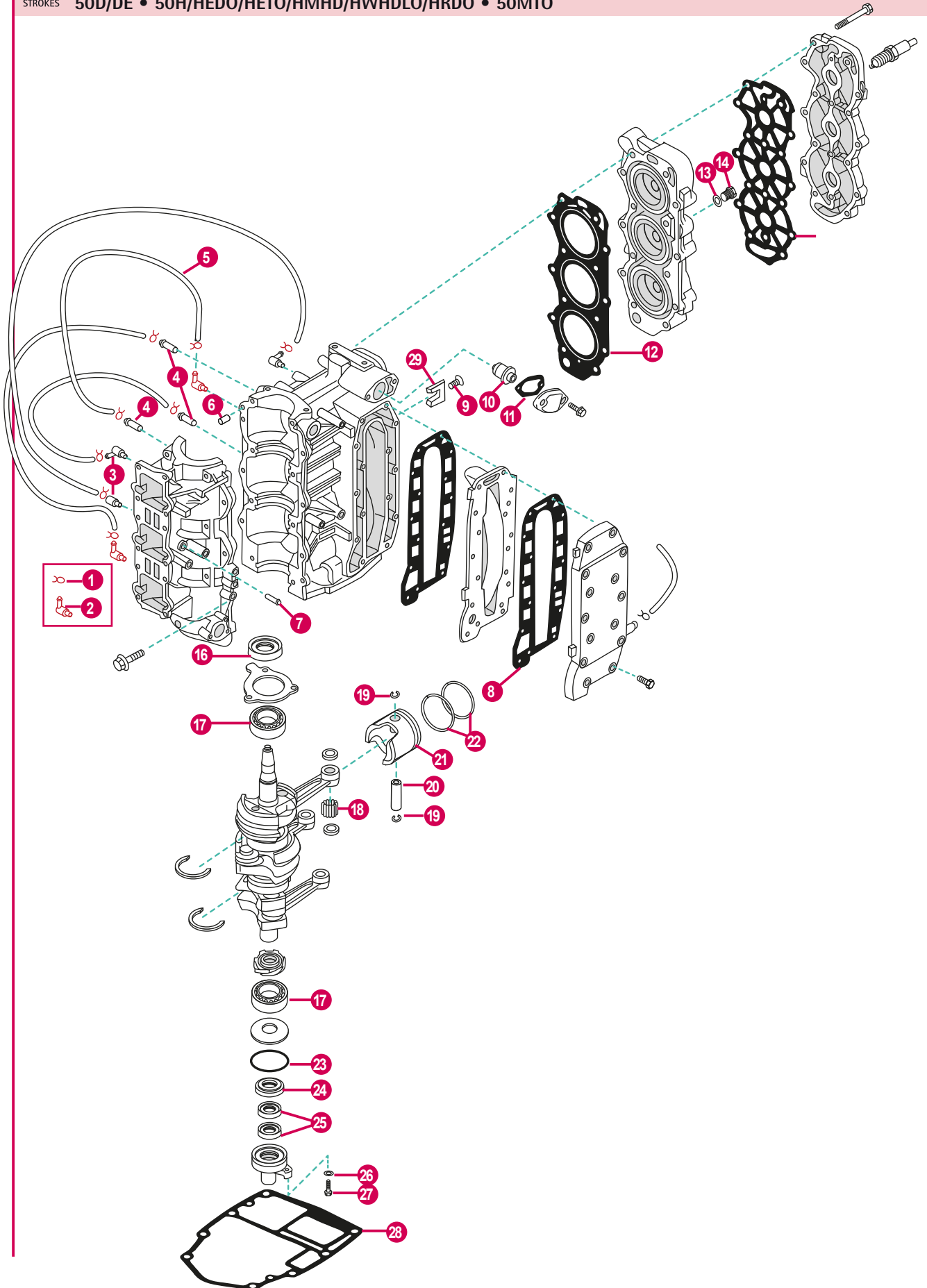

	REF	OEM			UN.
1	PAHT-2.5X60	90467-06016	CLIP	CLIP	8
2	REC688-11370-00	688-11370-01	NIPLE DE MANGUERA	NIPPLE	2
3	REC650-11370-00	650-11370-01	NIPLE DE MANGUERA	NIPPLE	2
4	REC624-14485-00	624-14485-00	PIPA DE AGUA	PIPE, WATER	3
5	PAF2.6-04000015	90445-07MA3	TUBO L200	HOSE L200	1
6	REC93606-12019	93606-12019	PIN CENTRADOR	HOLLOW PIN	2
7	PAF4-04010102	650-24378-00	PIPA DE AGUA	PIPE, WATER	1
8	REC6H4-41114-A0	6H4-41114-A0	JUNTA EXTERIOR, TAPA DE ESCAPE	GASKET, EXHAUST OUTER COVER	1
9	PAGB/T820-M4X12	98780-04016	TORNILLO	SCREW	2
10	REC6E5-12411-30	6E5-12411-30	TERMOSTATO	THERMOSTAT	1
11	REC61A-12414-A0	6J8-12414-A0	JUNTA TAPA TERMOSTATO	GASKET, THERMOSTAT COVER	1
12	REC63D-11181-A1	63D-11181-A2	JUNTA CULATA	GASKET, CYLINDER HEAD	1
13	PAF15-04000003	90430-14115	JUNTA	GASKET	1
14	PAF15-04000002	90340-14M00	TAPÓN	PLUG	1
15	REC63D-11193-A0	63D-11193-A0	JUNTA TAPA	GASKET, COVER	1
16	REC93102-23096	93102-23096	RETÉN DE ACEITE	OIL SEAL	1
17	REC93306-305U8	93306-305-U8	RODAMIENTO	BEARING	2
18	REC93602-20M02	93602-20M02	AGUJAS DEL RODAMIENTO	BEARING NEEDLE	93
19	REC6H4-11634-01	6H4-11634-01	CIRCLIP	CIRCLIP	6
20	REC648-11633-00	648-11633-00	PIN, PISTÓN	PIN, PISTON	3
	REC6H4-11631-01K	6H4-11631-01-95	PISTÓN STD	PISTON STD	
21	REC6H4-11635-01K	6H4-11635-01	PISTÓN 0.25mm O/S	PISTON 0.25mm O/S	3
	REC6H4-11636-01K	6H4-11636-01	PISTÓN 0.50mm O/S	PISTON 0.50mm O/S	
22	REC63D-11603-00	63D-11603-00	KIT SEGMENTOS STD	PISTON RING SET STD	3
	REC63D-11605-00	63D-11605-00	KIT SEGMENTOS DE PISTÓN 0.50mm O/S	PISTON RING SET 0.50mm O/S	
23	REC93210-57M09	93210-58M21	TÓRICA	O-RING	1
24	REC93102-25M28	93102-25M28	RETÉN DE ACEITE	OIL SEAL	1
25	REC93104-16M01	93104-16M01	RETÉN DE ACEITE	OIL SEAL	2
26	PAGB/T5783-M5X12	92995-06600	ARANDELA	WASHER	1
27	PAGB/T5783-M6X20	97095-06020	TORNILLO	BOLT	1
28	REC6H4-45113-00	6H4-45113-00	JUNTA BASE MOTOR	GASKET ENGINE	1
29	REC688-11325-00AL	688-11325-00	ÁNODO	ANODE	1



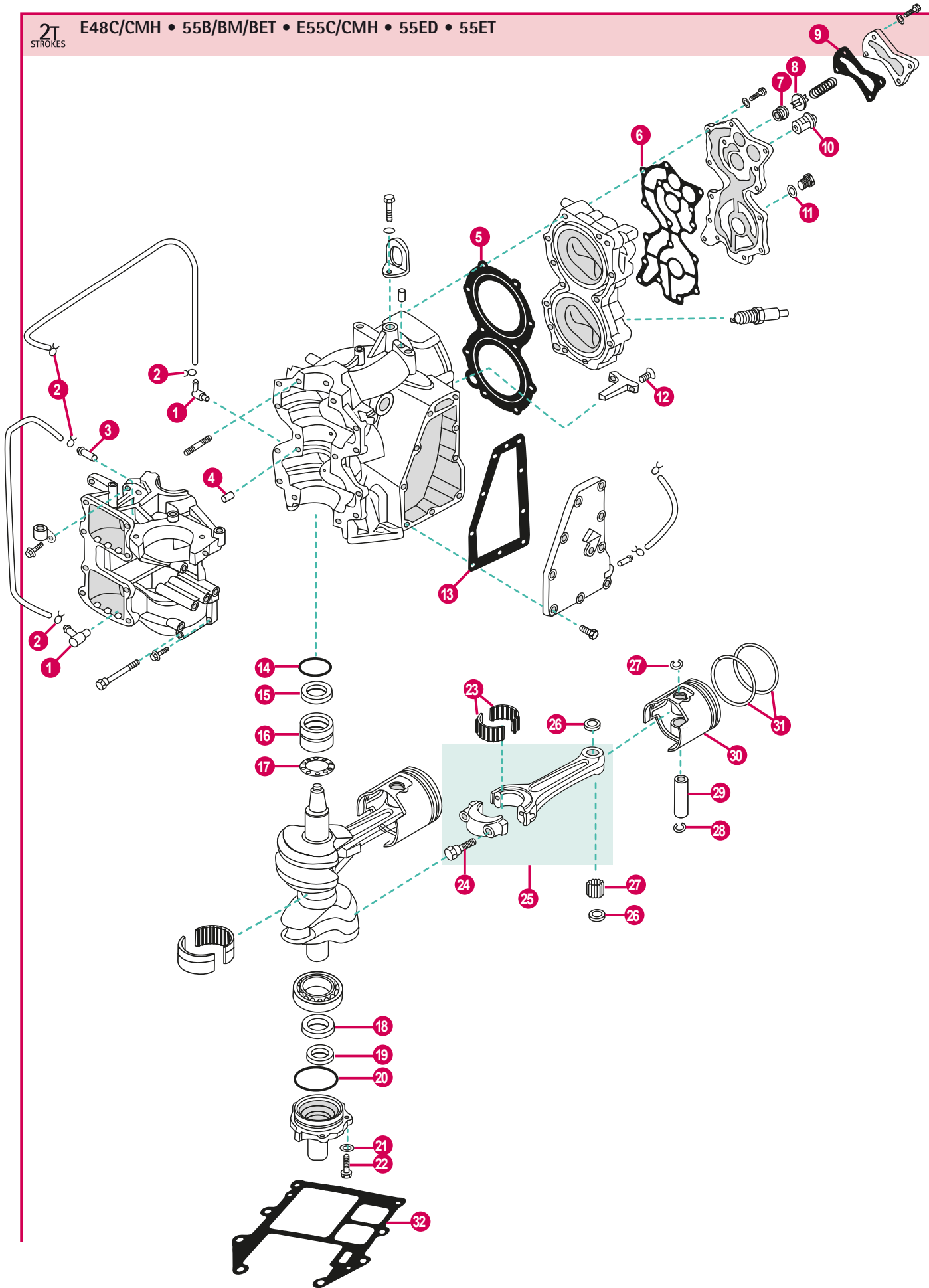

	REF	OEM		UN.	
1	REC650-11370-00	650-11370-01	NIPLE DE MANGUERA	NIPPLE	2
2	PAHT-2.5X60	90467-06016	PRESILLA	CLIP	4
3	REC624-14485-00	624-14485-00	PIPA DE AGUA	PIPE, WATER	1
4	PAF25-00000014	93608-12063	PIN CENTRADOR	HOLLOW PIN	1
5	REC697-11181-A1	697-11181-A2	JUNTA CULATA	GASKET, CYLINDER HEAD	1
6	REC663-11193-00	663-11193-A0	JUNTA TAPA	GASKET, COVER	1
7	REC90480-18065	90480-18065	TAPÓN	GROMMET	1
8	REC663-12416-00	663-12416-00	VÁLVULA DE PRESIÓN	VALVE, PRESSURE CONTROL	1
9	REC663-12414-00	663-12414-A0	JUNTA TAPA TERMOSTATO	GASKET, THERMOSTAT COVER	1
10	REC6F5-12411-03	6F5-12411-02	TERMOSTATO	THERMOSTAT	1
11	PAF15-04000003	90430-14115	JUNTA	GASKET	1
12	PAGB/T820-M4X12	98780-04015	TORNILLO CABEZA PLANA	SCREW, FLAT HEAD	2
13	REC663-41114-00	663-41114-A0	JUNTA DE ESCAPE	EXHAUST GASKET	1
14	REC93210-42159	93210-42159	TÓRICA	O-RING	1
15	REC93102-32M07	93102-32M07	RETÉN DE ACEITE	OIL SEAL	1
16	REC93311-632U1	93311-632U1	COJINETE DE RODILLOS	BEARING	1
17	REC663-11561-00	663-11561-00	ARANDELA PLANA	CHIM, RANK	1
18	REC93102-28135	93102-28135	RETÉN DE ACEITE	OIL SEAL	1
19	REC93104-18049	93104-18049	RETÉN DE ACEITE	OIL SEAL	1
20	REC93210-62269	93210-62269	TÓRICA	O-RING	1
21	PAGB/T96-6	92995-06600	ARANDELA	WASHER	3
22	PAGB/T5783-M6X16	97095-06016	PERNO	BOLT	3
23	REC93310-730V8	93310-730V8	COJINETE DE RODILLOS	BEARING	2
24	REC90109-08022	90109-08022	PERNO	BOLT	2
25	REC688-11650-03	688-11650-03	BIELA COMPLETA	CONNECTING ROD ASSY	2
26	REC90201-20417	90201-20417	ARANDELA PLANA	WASHER	4
27	REC93603-21111	93603-21111	AGUJA DE RODAMIENTO	BEARING NEEDLE	56
28	REC688-11634-00	688-11634-00	CIRCLIP	CIRCLIP	4
29	REC663-11633-00	663-11633-00	PIN, PISTÓN	PIN, PISTON	2
	REC688-11631-03K	688-11631-03-94	PISTÓN STD	PISTON STD	
30	REC688-11635-03K	688-11635-03	PISTÓN 0.25mm O/S	PISTON 0.25mm O/S	2
	REC688-11636-03K	688-11636-03	PISTÓN 0.50mm O/S	PISTON 0.50mm O/S	
31	REC688-11603-A0	688-11603-A0	KIT SEGMENTOS STD	PISTON RING SET STD	2
	REC688-11605-A0	688-11605-A0	KIT SEGMENTOS DE PISTÓN 0.50mm O/S	PISTON RING SET 0.50mm O/S	
32	REC696-45113-00	696-45113-00	JUNTA BASE MOTOR	GASKET ENGINE	1



2T
STROKES

50G/GEO/GETO • 60F/FEDO/FEHT/FEO/FET/FETO • 60TDR/TLR-B/TR-Z •
70B/BEHDO/BEMO/BEO/BETO • 70TDR/TR

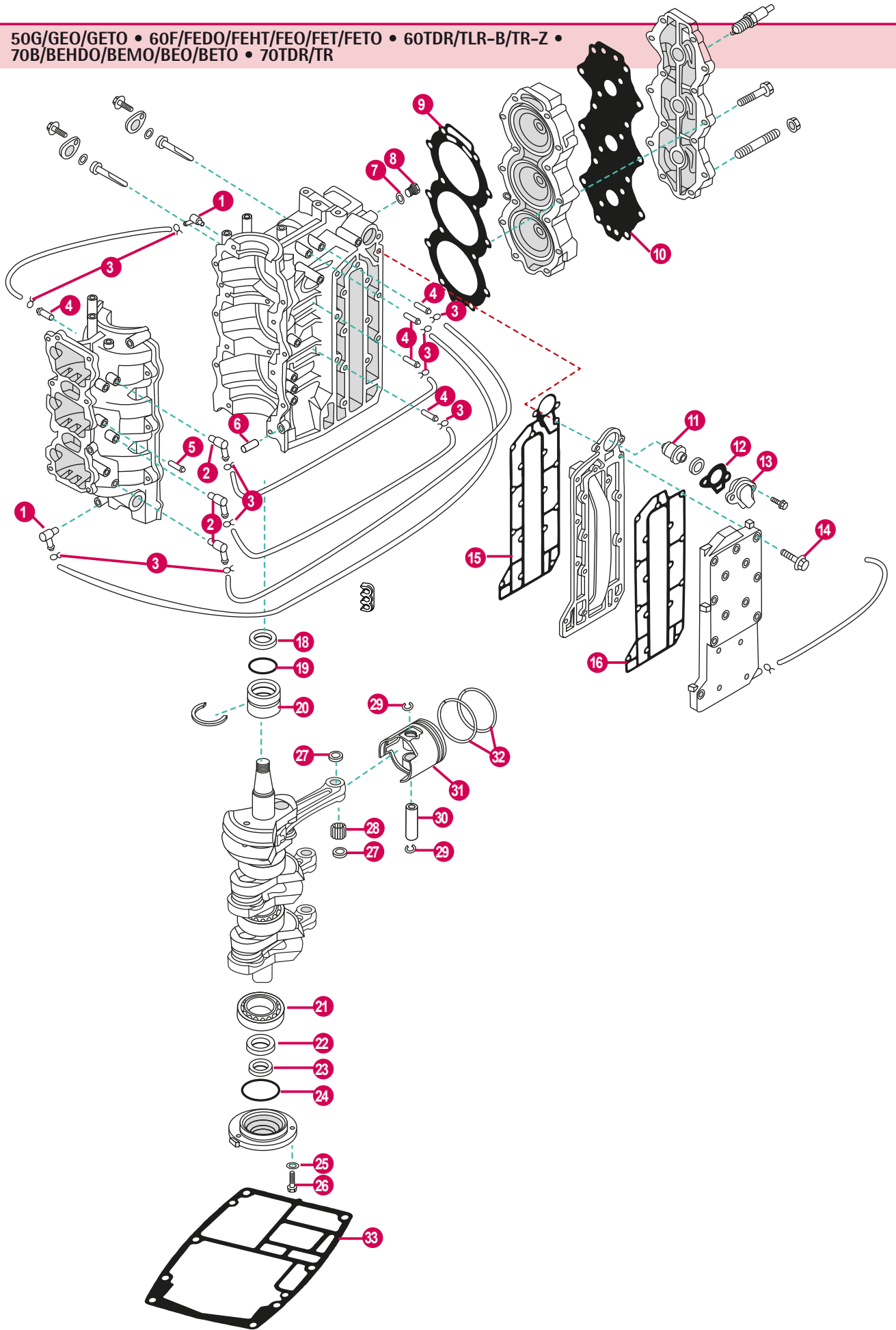

	REF	OEM		UN.	
1	REC688-11370-00	688-11370-01	NIPLE DE MANGUERA	NIPPLE	2
2	REC650-11370-00	650-11370-01	NIPLE DE MANGUERA	NIPPLE	3
3	PAHT-2.5X60	90467-06016	CLIP	CLIP	10
4	REC624-14485-00	624-14485-00	PIPA DE AGUA	PIPE, WATER	5
5	PAF4-04010102	650-24378-00	PIPA DE AGUA	PIPE, WATER	4
6	PAF25-00000014	93608-12063	PIN CENTRADOR	HOLLOW PIN	2
7	PAF15-04000003	90430-14115	JUNTA	GASKET	1
8	PAF15-04000002	90340-14M00	TAPÓN	PLUG STRAIGHT SREW	1
9	REC6H3-11181-A0	6H3-11181-A2	JUNTA CULATA	GASKET, CYLINDER HEAD	1
10	REC6H3-11193-A1	6H3-11193-A1	JUNTA CULATÍN	GASKET COVER	1
11	REC6H3-12411-10	6H3-12411-10	TERMOSTATO	THERMOSTAT	1
12	REC6H3-12414-A1	6H3-12414-A1	JUNTA TAPA TERMOSTATO	GASKET, THERMOSTAT COVER	1
13	PAF15-07010021	6H3-12413-00-1S	TAPA TERMOSTATO	COVER, THERMOSTAT	1
14	PAGB/T5782-M6X35	90119-06MA5	TORNILLO	BOLT	16
15	REC6H3-41112-A0	6H3-41112-A0	JUNTA DE ESCAPE	EXHAUST GASKET	1
16	REC6H3-41114-A0	6H3-41114-A0	JUNTA EXTERIOR, TAPA DE ESCAPE	GASKET, EXHAUST OUTER COVER	1
18	REC93102-36M24	93102-36M24	RETÉN DE ACEITE	OIL SEAL	1
19	REC93210-46M16	93210-46M16	TÓRICA	O-RING	1
20	REC93311-636U6	93311-636U6	RODAMIENTO	BEARING	1
21	REC93306-306V1	93306-306V1	RODAMIENTO	BEARING	1
22	REC93102-30M23	93102-30M23	RETÉN DE ACEITE	OIL SEAL	1
23	REC93106-18M01	93106-18M01	RETÉN DE ACEITE	OIL SEAL	1
24	REC93210-65M50	93210-65M50	TÓRICA	O-RING	1
25	PAGB/T97.1-8	92995-06600	ARANDELA	WASHER	3
26	PAGB/T5783-M6X20	97095-06020	TORNILLO	BOLT	3
27	REC90201-20417	90201-20417	ARANDELA	WASHER	6
28	REC93603-18M09	93603-18M09	AGUJA DE RODAMIENTO	BEARING NEEDLE	84
29	REC688-11634-00	688-11634-10	CIRCLIP	CIRCLIP	6
30	REC6H3-11633-00	6H3-11633-00	PIN, PISTÓN	PIN, PISTON	3
	REC6H3-11631-01K	6H3-11631-01-96	PISTÓN STD	PISTON STD	
31	REC6H3-11635-01K	6H3-11635-01	PISTÓN 0.25mm O/S	PISTON 0.25mm O/S	3
	REC6H3-11636-01K	6H3-11636-01	PISTÓN 0.50mm O/S	PISTON 0.50mm O/S	
	REC6K5-11601-02	6K5-11601-02	KIT SEGMENTOS STD	PISTON RING SET STD	
32	REC6K5-11601-12	6K5-11601-12	KIT SEGMENTOS DE PISTÓN 0.25mm O/S	PISTON RING SET 0.25mm O/S	3
	REC6K5-11601-22	6K5-11601-22	KIT SEGMENTOS DE PISTÓN 0.50mm O/S	PISTON RING SET 0.50mm O/S	
33	REC6H3-45113-00	6H3-45113-00	JUNTA BASE MOTOR	GASKET ENGINE	1

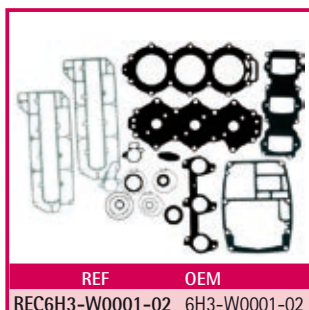
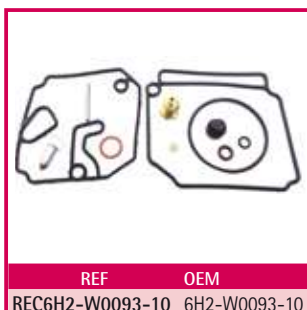

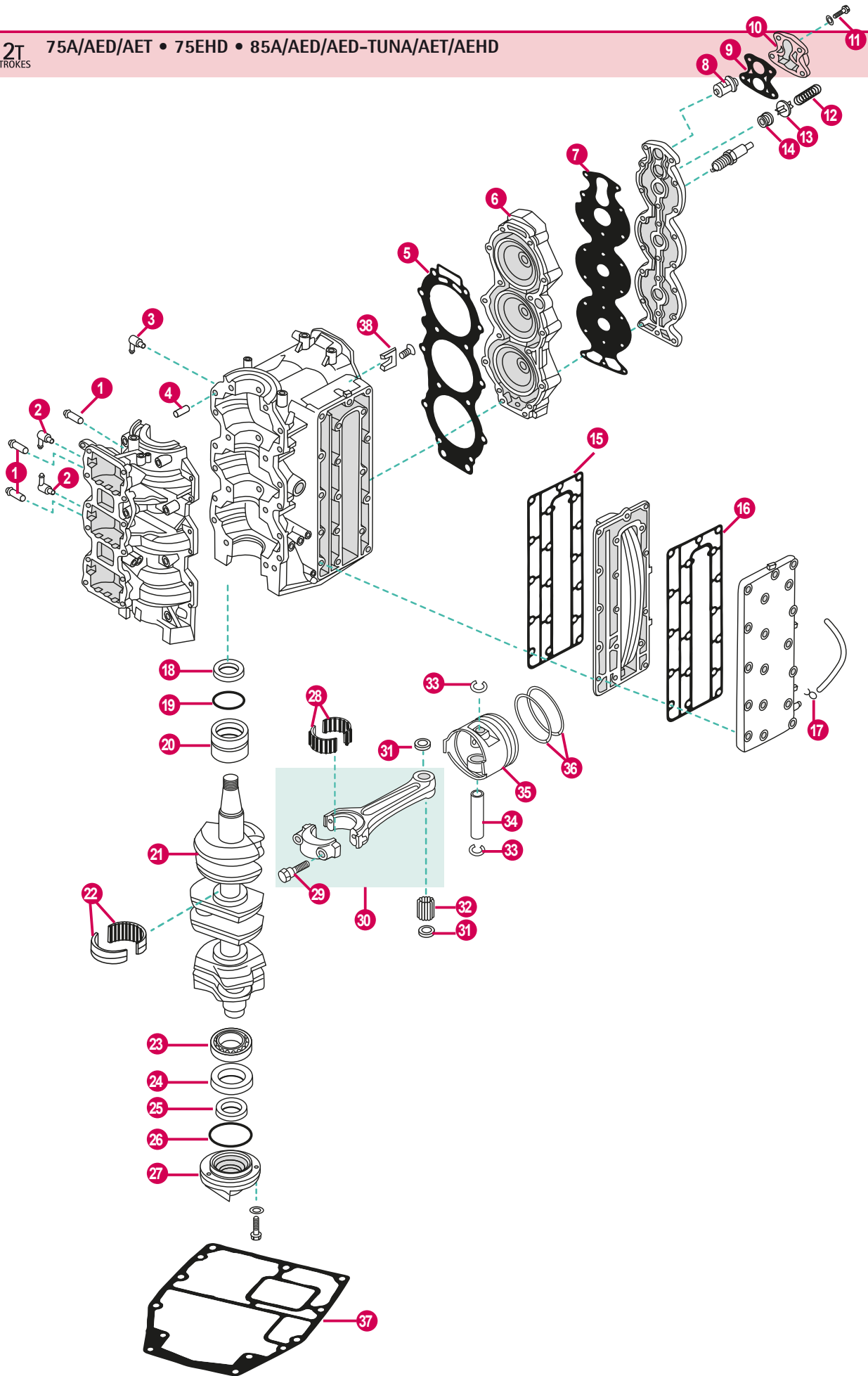

	REF	OEM			UN.
1	REC624-14485-00	624-14485-00	PIPA DE AGUA	PIPE, WATER	4
2	REC688-11370-00	688-11370-01	NIPLE DE MANGUERA	NIPPLE	2
3	REC650-11370-00	650-11370-01	NIPLE DE MANGUERA	NIPPLE	1
4	PAF25-00000014	93608-12063	PIN CENTRADOR	HOLLOW PIN	2
5	REC688-11181-A1	688-11181-A1	JUNTA CULATA	GASKET, CYLINDER HEAD	1
6	REC688-11111-02-1S	688-11111-02-1S	CULATA	CYLINDER HEAD	1
7	REC688-11193-A1	688-11193-A1	JUNTA TAPA	GASKET, COVER	1
8	REC6E5-12411-30	688-12411-10	TERMOSTATO	THERMOSTAT	1
9	REC688-12414-A1	688-12414-A1	JUNTA TAPA TERMOSTATO	GASKET, THERMOSTAT COVER	1
10	REC688-12413-00-1S	688-12413-00-1S	TAPA TERMOSTATO	COVER, THERMOSTAT	1
11	PAGB/T5783-M6X35	90119-06MA5	TORNILLO	BOLT, WITH WASHER	4
12	REC90501-16M11	90501-16M11	MUELLE	SPRING COMPRESSION	1
13	REC688-12416-00	688-12416-00	VÁLVULA CONTROL DE PRESIÓN	VALVE, PRESSURE CONTROL	1
14	REC90480-20M05	90480-20M05	JUNTA GOMA	GROMMET	1
15	REC688-41112-A0	688-41112-A0	JUNTA DE ESCAPE	EXHAUST GASKET	1
16	REC688-41114-A0	688-41114-A0	JUNTA EXTERIOR, TAPA DE ESCAPE	GASKET, EXHAUST OUTER COVER	1
17	PAF4-04000030	90467-08004	PRESILLA	CLAMP	
18	REC93102-36M02	93102-36M02	RETÉN DE ACEITE	OIL SEAL	1
19	REC93210-46M16	93210-46M16	TÓRICA	O-RING	1
20	REC93310-636U4	93310-636U4	RODAMIENTO	BEARING	1
21	REC688-11411-00	688-11411-01	CIGÜEÑAL	CRANK ASSY	1
22	REC93310-835U8	93310-835U8	RODAMIENTO	BEARING	2
23	REC93306-206U5	93306-206U5	RODAMIENTO	BEARING	1
24	REC93102-30M05	93102-30M05	RETÉN DE ACEITE	OIL SEAL	1
25	REC93104-20M02	93104-20M02	RETÉN DE ACEITE	OIL SEAL	1
26	REC93210-62269	93210-62269	TÓRICA	O-RING	1
27	REC6H1-15359-01-94	6H1-15359-01-94	CUERPO DEL RETÉN	SHELL, OIL SEAL	1
28	REC93310-730V8	93310-730V8	COJINETE DE BIELA	BEARING, CONNECTING ROD	3
29	REC90109-08022	90109-08022	TORNILLO	BOLT	2
30	REC688-11650-03	688-11650-03	BIELA	CONNECTING ROD ASSY	3
31	REC90201-20417	90201-20417	ARANDELA	WASHER PLATE	6
32	REC93603-21111	93603-21111	AGUJA DE RODAMIENTO	BEARING NEEDLE	84
33	REC688-11634-00	688-11634-00	CIRCLIP	CIRCLIP	6
34	REC663-11633-00	663-11633-00	PIN, PISTÓN	PIN, PISTON	3
35	REC688-11631-03K	688-11631-03-94	PISTÓN STD	PISTON STD	3
36	REC688-11603-A0	688-11603-A0	KIT SEGMENTOS STD	PISTON RING SET STD	3
	REC688-11605-A0	688-11605-A0	KIT SEGMENTOS DE PISTÓN 0.50mm O/S	PISTON RING SET 0.50mm O/S	
37	REC688-45113-A0	688-45113-A0	JUNTA BASE MOTOR	GASKET ENGINE	1
38	REC688-11325-00AL	688-11325-00	ÁNODO	ANODE	1

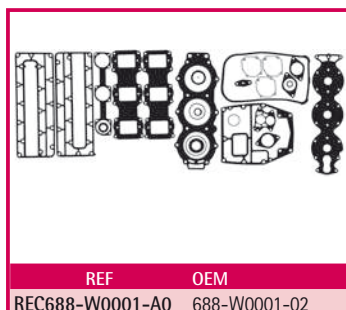
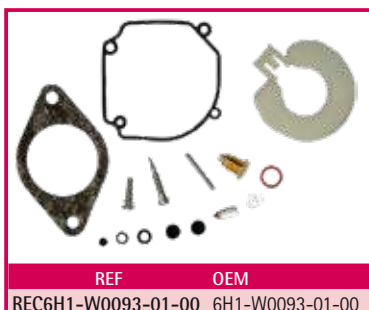

2T
STROKES

100A/AETO • 100TLR • 115AEL/B/BETO/BE-TR/C/CEO/CETO • C115TLR • 130B/BETO • 130TLR/TLRZ • 140A • 140B

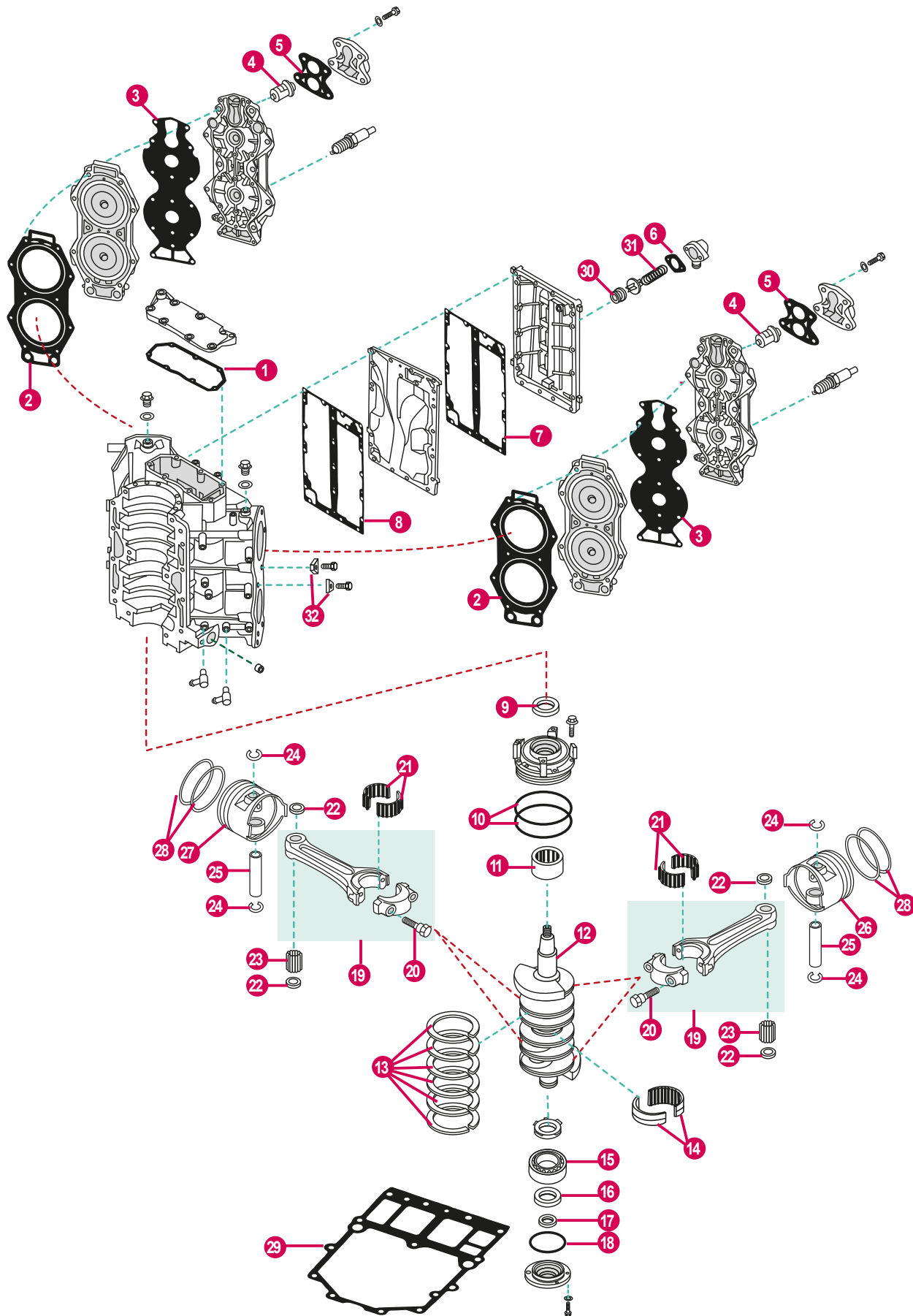

YAMAHA

RECMOIR®

	REF	OEM			UN.
1	REC6E5-11381-A1	6E5-11381-A2	JUNTA	GASKET	1
2	REC6E5-11181-A0	6E5-11181-A2	JUNTA CULATA	GASKET, CYLINDER HEAD	2
3	REC6E5-11193-A0	6E5-11193-A0	JUNTA CULATÍN	GASKET, HEAD COVER	2
4	REC6E5-12411-30	6E5-12411-30	TERMOSTATO	THERMOSTAT	2
5	REC688-12414-A1	688-12414-A1	JUNTA TAPA TERMOSTATO	GASKET, THERMOSTAT COVER	2
6	REC6G5-11382-A1	6G5-11382-A1	JUNTA	GASKET	1
7	REC6E5-41112-A1	6E5-41112-A1	JUNTA EXTERIOR, TAPA DE ESCAPE	GASKET, EXHAUST OUTER COVER	1
8	REC6E5-41112-A1	6E5-41112-A1	JUNTA DE ESCAPE	EXHAUST GASKET	1
9	REC93102-40M38	93102-40M14	RETÉN DE ACEITE	OIL SEAL	1
10	REC93211-04001	93211-04001	TÓRICA	O-RING	2
11	REC93311-940U3	93311-940U3	RODAMIENTO	BALL BEARING	1
12	REC6N7-11411-00	6N7-11411-00	CIGÜEÑAL	CRANKSHAFT	1
13	REC6E5-11447-00	6E5-11447-00	ARO	SEAL, CRANK	6
14	REC93310-954U1	93310-954U1	RODAMIENTO	BALL BEARING	1
15	REC93306-208U0	93306-208U0	RODAMIENTO	BALL BEARING	1
16	REC93102-35M13	93102-35M13	RETÉN DE ACEITE	OIL SEAL	1
17	REC93101-22M15	93101-22M15	RETÉN DE ACEITE	OIL SEAL	1
18	REC93210-74M35	93210-74M35	TÓRICA	O-RING	1
19	REC6R5-11650-10	6R5-116950-0	BIELA	CONNECTING ROD ASSY	4
20	REC90109-08M71	90109-08M71	TORNILLO	BOLT	8
21	REC93310-836V2	93310-836V2	COJINETE DE BIELA	BEARING, CONNECTING ROD	4
22	REC90201-23M01	90201-23M01	ARANDELA	WASHER	8
23	REC93310-32337	93310-323V6	AGUJA DE RODAMIENTO	BEARING NEEDLE	4
24	REC6R5-11634-00	6R5-11634-10	CIRCLIP	CIRCLIP	8
25	REC6R5-11633-00	6R5-11633-10	PIN, PISTÓN	PIN, PISTON	4
26	REC6R5-11642-01K	6R5-11642-11-93	PISTÓN STD 2	PISTON STD 2	2
27	REC6R5-11631-11K	6R5-11361-11-93	PISTÓN STD 1	PISTON STD 1	2
	REC64D-11603-01	64D-11603-01	KIT SEGMENTOS DE PISTÓN STD	PISTON RING SET STD	
28	REC64D-11604-01	64D-11604-01	KIT SEGMENTOS DE PISTÓN 0.25mm O/S	PISTON RING SET 0.25mm O/S	4
	REC64D-11605-01	64D-11605-01	KIT SEGMENTOS DE PISTÓN 0.50mm O/S	PISTON RING SET 0.50mm O/S	
29	REC6G5-45113-A1	6G5-45113-A1	JUNTA BASE MOTOR	GASKET ENGINE	1
30	REC90480-20M05	90480-20M05	JUNTA GOMA	GROMMET	1
31	REC90501-16 M11	90501-16M11	MUELLE	SPRING COMPRESSION	1
32	REC6E5-11325-00AL	6E5-11325-00	ÁNODO	ANODE	2



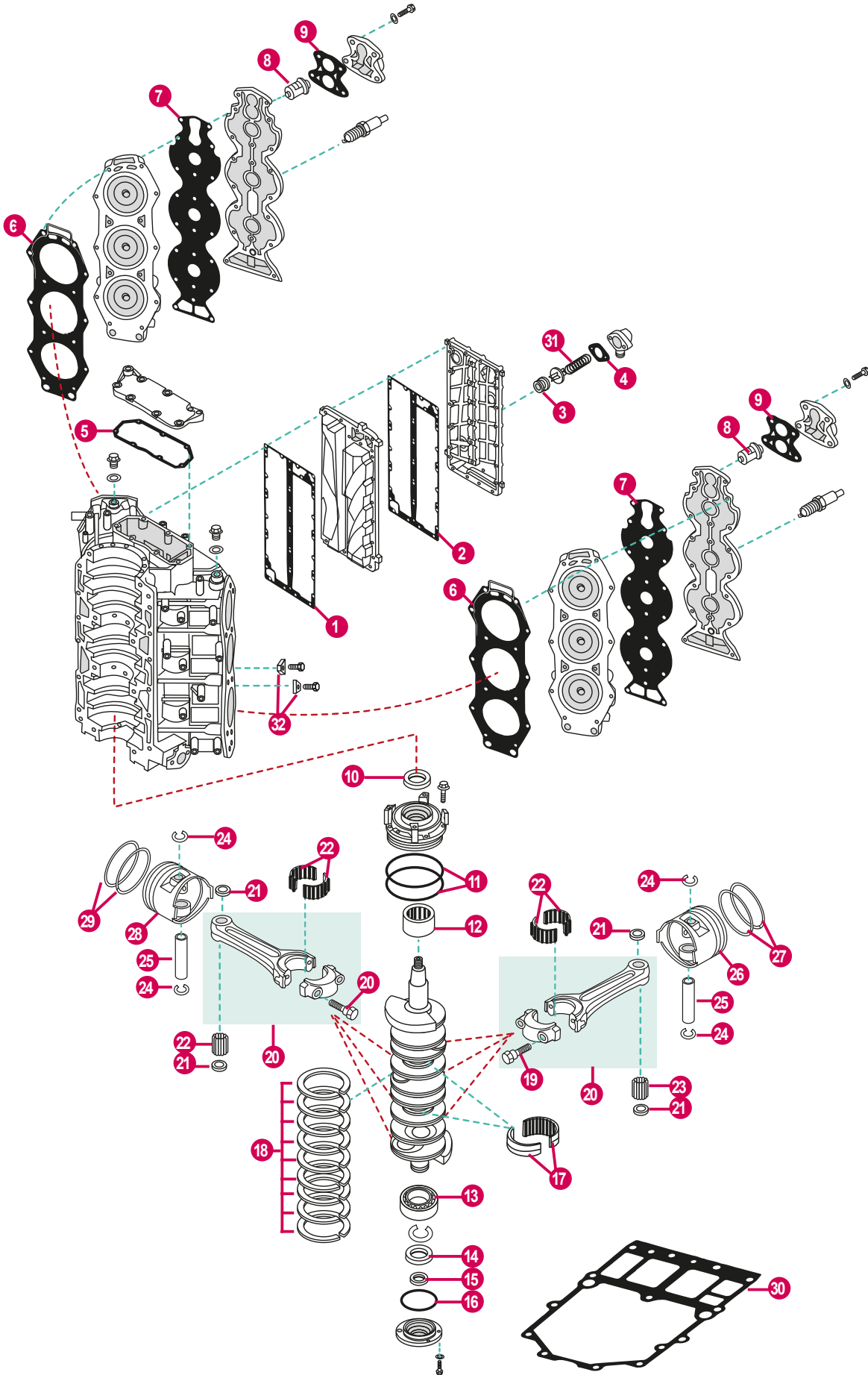

	REF	OEM			UN.
1	REC6G5-41112-A1	6G5-41112-A1	JUNTA DE ESCAPE	EXHAUST GASKET	1
2	REC6G5-41112-A1	6G5-41114-A0	JUNTA EXTERIOR, TAPA DE ESCAPE	GASKET, EXHAUST OUTER COVER	1
3	REC90480-20M05	90480-20M05	JUNTA DE GOMA	GROMMET	1
4	REC6G5-11382-A1	6G5-11382-A1	JUNTA	GASKET	1
5	REC6E5-11381-A1	6E5-11381-A2	JUNTA	GASKET	1
6	REC6G5-11181-A2	6G5-11181-A3	JUNTA CULATA	GASKET, CYLINDER HEAD	2
7	REC6G5-11193-A0	6F5-11193-A0	JUNTA TAPA	GASKET, COVER	2
8	REC6E5-12411-30	6E5-12411-30	TERMOSTATO	THERMOSTAT	2
9	REC688-12414-A1	688-12414-A1	JUNTA TAPA TERMOSTATO	GASKET, THERMOSTAT COVER	2
10	REC93102-40M38	93102-40M14	RETÉN DE ACEITE	OIL SEAL	1
11	REC93211-04001	93211-04001	TÓRICA	O-RING	2
12	REC93311-940U3	93311-940U3	RODAMIENTO	BEARING	1
13	REC93306-208U0	93306-208U0	RODAMIENTO	BEARING	1
14	REC93102-35M13	93102-35M13	RETÉN DE ACEITE	OIL SEAL	1
15	REC93101-22M15	93101-22M15	RETÉN DE ACEITE	OIL SEAL	1
16	REC93210-74M35	93210-74M35	TÓRICA	O-RING	1
17	REC93310-954U1	93310-954U1	RODAMIENTO	BEARING	1
18	REC6E5-11447-00	6E5-11447-00	ARILLO	SEAL, CRANK	9
19	REC90109-08022	90109-08022	TORNILLO	BOLT	2
20	REC6R5-11650-10	6F5-11650-11	BIELA	CONNECTING ROD ASSY	6
21	REC93310-836V2	93310-836V2	COJINETE DE BIELA	BEARING, CONNECTING ROD	6
22	REC90201-23M01	90201-23M01	ARANDELA	WASHER PLATE	12
23	REC93310-32337	93310-32337	AGUJA DE RODAMIENTO	BEARING NEEDLE	6
24	REC6R5-11634-00	6R5-11634-10	CIRCLIP	CIRCLIP	12
25	REC6R5-11633-00	6R5-11633-10	PIN, PISTÓN	PIN, PISTON	6
26	REC64D-11642-00K	64D-11642-02-90	PISTON STD 2	PISTON STD 2	3
	REC64D-11603-01	64D-11603-02	KIT SEGMENTOS DE PISTÓN STD	PISTON RING SET STD	
27	REC64D-11604-01	64D-11604-01	KIT SEGMENTOS DE PISTÓN 0.25mm O/S	PISTON RING SET 0.25mm O/S	3
	REC64D-11605-01	64D-11605-02	KIT SEGMENTOS DE PISTÓN 0.50mm O/S	PISTON RING SET 0.50mm O/S	
28	REC64D-11631-00K	64D-11631-02-90	PISTON STD 1	PISTON STD 1	3
	REC64D-11603-01	64D-11603-02	KIT SEGMENTOS DE PISTÓN STD	PISTON RING SET STD	
29	REC64D-11604-01	64D-11604-02	KIT SEGMENTOS DE PISTÓN 0.25mm O/S	PISTON RING SET 0.25mm O/S	3
	REC64D-11605-01	64D-11605-02	KIT SEGMENTOS DE PISTÓN 0.50mm O/S	PISTON RING SET 0.50mm O/S	
30	REC6G5-45113-A1	6G5-45113-A1	JUNTA BASE MOTOR	GASKET ENGINE	1
31	REC90501-16M11	90501-16M11	MUELLE	SPRING COMPRESSION	1
32	REC6E5-11325-00AL	6E5-11325-00	ÁNODO	ANODE	2



REF	OEM
REC64D-W0093-00	64D-W0093-00



JUNTAS DE MOTOR 2 TIEMPOS

ENGINE GASKET 2 STROKES



2T
STROKES

JUNTAS DE CULATA



CYLINDER HEAD GASKET



REF	OEM		
REC6F8-11181-A0	6F8-11181-A1	2CMH (2003+)	



REF	OEM		
REC6H3-11181-A0	6H3-11181-A2	25B, 50G 60T, E60, 60FE 70B/ET/CE (1984+)	

REF	OEM		
REC677-11181-A0	677-11181-A1	E8D/DMH (1997-03)	



REF	OEM		
REC689-11181-00	689-11181-A2	30A (1990-92)	



REF	OEM		
REC63V-11181-A1	63V-11181-A1	9.9F/MH/MSH E9.9D, E15D 15F/FMH/MSH 13.5 AWH/AMH (1995+)	

REF	OEM		
REC6J8-11181-A2	6J8-11181-A2	30D 25J (1986+)	



REF	OEM		
REC6E7-11181-00	6E7-11181-A2	9.9D 15D (1988-96)	

REF	OEM		
REC6H4-11181-00	6H4-11181-A2	25Q, 40N/H 50E/D (1984-94)	

REF	OEM		
REC695-11181-00	695-11181-A1	20C 25D (1986-02)	

REF	OEM		
REC63D-11181-A1	63D-11181-A2	40V, C40/EL/TLR/Y 50H/TLR/TR (1995+)	

REF	OEM		
REC61N-11181-00	61N-11181-A2	25VE/VM, E25A/BMH 30G E30HMH/H (1996-12)	

REF	OEM		
REC6R7-11181-A0	6R7-11181-A1	40G (1993)	

YAMAHA

REF	OEM	
REC676-11181-01	676-11181-A2	40QE/QM/QWC (1990-98)



REF	OEM	
REC688-11181-A1	688-11181-A2	75A/AE/CET 80A/AE 85A/AE 90A/AE/TR (1986-14)



REF	OEM	
REC66T-11181-00	66T-11181-A0	40X E40X/M (1998-09)



REF	OEM	
REC6E5-11181-A0	6E5-11181-A2	100A, 115A/E/B/C C115T 130B 140A (1984+)



REF	OEM	
REC6F5-11181-A2	6F5-11181-A2	40GWH/JWH E40GMH/JMH (2003)



REF	OEM	
REC6G5-11181-A2	6G5-11181-A3	150A/E/C/AET 175AET/B/D 200AET/B/C/FETGE 225AET/BETO/D



REF	OEM	
REC697-11181-A1	697-11181-A2	E55CMH E48CMH 55BET 55B/BE/BM (1990-05)





REF	OEM	
REC68F-11181-00	68F-11181-00	Z/VZ/LZ200 (2001-07) Z/VZ/LZ150 (2000-07) Z/VZ175 (2001-07)



2T
STROKES

**KITS
JUNTAS DE CULATA**

REF	OEM	
REC63V-W0001-00	63V-W0001-01	9.9-15F/FMH/FEMH/MSH (1995-00) 13.5AWH (1998)



**CYLINDER HEAD GASKET
KIT**

REF	OEM	
REC6E7-W0001-A1	6E7-W0001-00 6E7-W0001-A1	9.9D 15D



REF	OEM	
REC6H3-W0001-02	6H3-W0001-02	25B/BETO (1994-95) 50G/GEO/GETOL (1994-98) 60FEO/FETO/FEDO/TLR/FEHTO/TR (1994-07)

REF	OEM	
REC6K5-W0001-02	6K5-W0001-02	E60H/MHZ/HE/HM (1996-02)

REF	OEM	
REC66T-W0001-01	66T-W0001-01	E40X/XMH/XW/MLHZ (2001-13)

REF	OEM	
REC688-W0001-A0	688-W0001-A0	75A/AE (1990-91) 85A/AE (1990-91)

REF	OEM	
REC6F6-W0001-02	6F6-W0001-02	E40GMH/S/L E40JMH E40JWH 40GWH 40JWH

REF	OEM	
REC6E5-W0001-A2	6E5-W0001-A2	L130BETO (1991-99) 115CEO/CETO (1991-96) 100A/AETO/TLR (1996-00)

REF	OEM	
REC697-W0001-02	697-W0001-A0	55BET (1990)

REF	OEM	
REC6R3-W0001-03	6R3-W0001-A3	L/150 CETO (1990-95) L/200 BETO (1993-95) 175BETO/ET (1990-95) L200ETD (1990), 200ET (1990) 150CED/ETD (1990)

JUNTAS BASE DE MOTOR

CYLINDER GASKET

REF	OEM	
REC6E5-W0001-A2	6E5-W0001-A2	4A/AC/AS/MSH 5C/CS/CMH



REF	OEM	
REC677-45113-A0	677-45113-A0	E8D/DMH



REF	OEM	
REC6G1-45113-A1	6G1-45113-A1	8N/C/J/T/M 6C/J/D/T/M

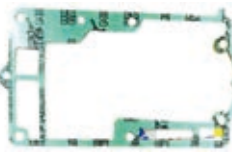

REF	OEM	
REC6B4-11351-A1	6B4-11351-A1	9.9/15 HP D 6B3-6B4 (2003)

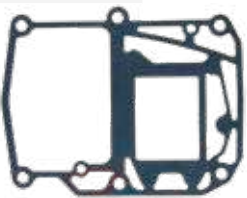

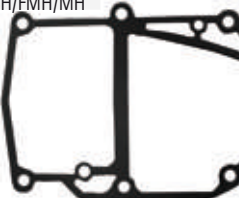

REF	OEM	
REC63V-45113-A1	63V-45113-A1	9.9FEM/F/MSH/FMH/MH 13.5 AW/AMH 15F/FEM/MSH/FMH/MH

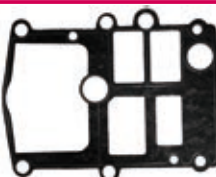

REF	OEM	
REC682-11351-A0	682-11351-A0	9.9D 15D



REF	OEM	
REC6L2-45113-A2	6L2-45113-A1	20D 25D/N/M



REF	OEM	
REC61T-45113-A0	61T-45113-A0	25VE/BMH 30G/HW





REF	OEM	
REC6H4-45113-00	6H4-45113-A0	25Q 40N/H/E/V/T/Y 50D/H/T

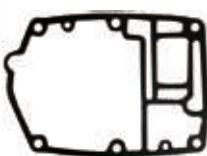

REF	OEM	
REC6J8-45113-00	6J8-45113-A0	25J 30D/DMH/DE/E/M





REF	OEM	
REC6F5-45113-A0	6F5-45113-A0	E40G/E40J/40G/40J/40Q



REF	OEM	
REC66T-45113-A0	66T-45113-A0	40X/E40X



REF	OEM	
REC696-45113-00	696-45113-A0	55B/E55 E48



REF	OEM	
REC688-45113-A0	688-45113-A0	75A/AE/CE/TL 85A/AE 80A/AE 90A/AE/ETN

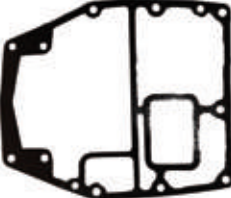

REF	OEM	
REC6E5-45113-A2	6E5-45113-A0	115B/ET 140AE/BE



REF	OEM	
REC6G5-45113-A1	6G5-45113-A2	115ETN/A/B, 130BE 150ETN/AET/CET/F/TXR/G, 140AET/BET 175AET/BET/DE, 150BET 200ETN/AET/CET/BET/AF/G 220AET, 225AET/BET/D

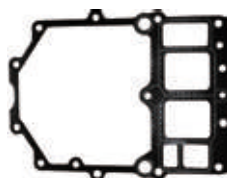

GUÍA JUNTAS DE MOTOR

ENGINE GASKET GUIDE

		CYL	JUNTA CULATA CYLINDER HEAD GASKET	KIT JOINTS	JUNTA BASE MOTOR CYLINDER GASKET
2CMH	2010	1	REC6F8-11181-A0		REC646-14623-A1
E8D/DMH	1997-03	2	REC677-11181-A0		REC677-45113-A0
9.9D	1988-96	2	REC6E7-11181-00	REC6E7-W0001-A1	REC682-45113-A0
9.9F/FM/MSH/E9.9D 13.5AWH/AMH	1995	2	REC63V-11181-A1	REC63V-W0001-00	REC63V-45113-A1
15D	1988-95	2	REC6E7-11181-00	REC6E7-W0001-A1	REC682-45113-A0
15F/FMH/MSH/E15D	1995	2	REC63V-11181-A1	REC63V-W0001-00	REC63V-45113-A1
20C	1986-02	2	REC695-11181-00		REC61T-45113-A0
20D/20DM	1988	2			REC6L2-45113-A2
25DE/M/N	1998	2			REC6L2-45113-A2
25DE/M/N	1986-02	2	REC695-11181-00		REC61T-45113-A0
25VE/VM/BMH/E25A	1996-12	2	REC61N-11181-00		REC61T-45113-A0
25Q/QEO	1990-94	3	REC6H4-11181-00		REC6H4-45113-00
25J/JEO/JETO	1987-99	3	REC6J8-11181-A2		REC6J8-45113-00
25B/BETO	1994-95	3	REC6H3-11181-A0	REC6H3-W0001-02	REC6H3-45113-00
25B/BMH	1996-10	2	REC61N-11181-00		REC61T-45113-A0
30A	1990-92	2	REC689-11181-00		REC61T-45113-A0
30G/E30HMH/H	1996-12	2	REC61N-11181-00		REC61T-45113-A0
30D	1986	3	REC6J8-11181-A2		REC6J8-45113-00
40QE/QM/QWC	1990-98	2	REC676-11181-01		REC6F5-45113-A0
40N/H	1984-94	3	REC6H4-11181-00		REC6H4-45113-00
40G	1993	2	REC6R7-11181-A0		REC6F5-45113-A0
40X/E40/M/X	1998	2	REC66T-11181-00	REC66T-W0001-01	REC66T-45113-A0
40/E40GMH/JMH	2003	2	REC6F5-11181-A2		REC6F5-45113-A0
40V/C40/EL/TLR/Y-YE	1995	3	REC63D-11181-A1		REC6H4-45113-00
E48	2003	2	REC697-11181-A1	REC697-W0001-02	REC696-45113-00
50H/TLR/TR	1995	3	REC63D-11181-A1		REC6H4-45113-00
50G/GEO/GETO	1993-02	3	REC6H3-11181-A0	REC6H3-W0001-02	REC6H3-45113-00
50E/D	1984-94	3	REC6H4-11181-00		REC6H4-45113-00
55B/E55	1990-05	2	REC697-11181-A1	REC697-W0001-02	REC697-45114-00
60FE/T/E60					
70B/ET/CE	1984	3	REC6H3-11181-A0	REC6H3-W0001-02	REC6H3-45113-00
70A/AE/CET	1986	3	REC688-11181-A1	REC688-W0001-A0	REC688-45113-A0
80A/AE	1986	3	REC688-11181-A1	REC688-W0001-A0	REC688-45113-A0
85A/AE	1986	3	REC688-11181-A1	REC688-W0001-A0	REC688-45113-A0
90A/AE/TR	1986	3	REC688-11181-A1	REC688-W0001-A0	REC688-45113-A0
100A					
115A/B/E/C/C115T 130B 140A	1984	4	REC6E5-11181-A0	REC6E5-W0001-A2	REC6E5-45113-A2
LZ150/VZ150/Z150	2004-05	6	REC68F-11181-00		
150A/E/C/FET	1984-10	6	REC6G5-11181-A2		REC6G5-45113-A1
VZ175/Z175	2004-10	6	REC68F-11181-00		
175D/B/AET	1984-10	6	REC6G5-11181-A2		REC6G5-45113-A1
LZ200/VZ200/Z200	2004-10	6	REC68F-11181-00		
200B/C/AET/GE/FET 225D/BET/AET	1984	6	REC6G5-11181-A2		REC6G5-45113-A1

JUNTAS DE CULATÍN

GASKET, HEAD COVER

REF	OEM	
REC61T-11193-A0	61T-11193-A1	25VE/VM/BMH/B E25A/BMH 30G/GE/HMH/HW MSH



REF	OEM	
REC663-11193-00	663-11193-A0	E48CMH, 55BET/B/BE/BM/BET E55CMH

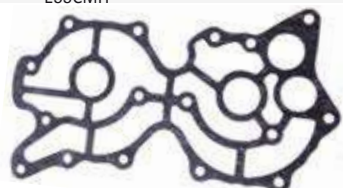

REF	OEM	
REC6H3-11193-A1	6H3-11193-A1	25B/BETO, 50G/GEO/GETO 60FEO/FETO/FEDO/TLR, E60H/ HMH/MLH 70B//BEO/BEMO/BETO/TR



REF	OEM	
REC63D-11193-A0	63D-11193-A0	50H/T (1995+) 40V/M/Y (1995+)

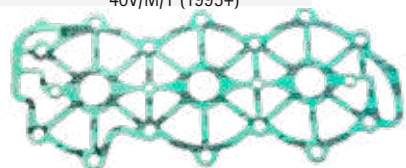

REF	OEM	
REC6H4-11193-A1	6H4-11193-00	25Q (1990-94) 40N/H (1984-91) 50E/D (1984-94)

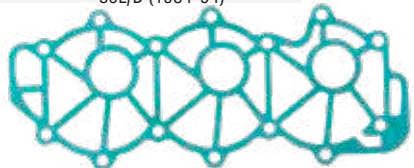



REF	OEM	
REC688-11193-A1	688-11193-A1	75CETO/TLR/AE E75B 80AEO/AETO/A 85A/AE 90AEO/TLR/A/AETO

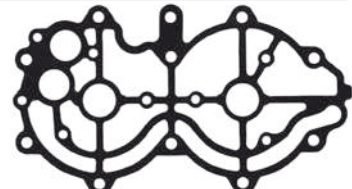

REF	OEM	
REC66T-11193-A0	66T-11193-A0	40X/E40X, E40 MLH/X/XW





REF	OEM	
REC6E5-11193-A0	6E5-11193-A0	100A/AETO/TLR 115B/BETO/BE C115TLR/CEO/CETO/TXR E115AEL 130BETO

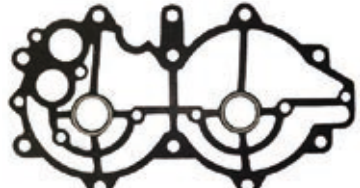

REF	OEM	
REC6F6-11193-A1	6F6-11193-A1	40GWH/JWH, E40GMH/JMH



REF	OEM	
REC6G5-11193-A0	6G5-11193-A1	150A/AET/CETO/F/FETO/TXR D150H 175D/DETO/BETO 200AET/CETO/FETO/G/GETO/ BETO/TXR/F/TLR, 225D/DET/BET



CIGÜEÑAL

CRANKSHAFT

2T
STROKES

GUÍA PARTES DE CIGÜEÑAL

GUIDE CRANKSHAFT PARTS

		1	2	3	4
9.9D	1985-97	REC682-11412-00	REC682-11422-00	REC682-11432-00	REC682-11442-00
9.9D	1988-95	REC63V-11412-00		REC6K4-11432-00	REC682-11442-00
9.9F/MH	1995-14	REC63V-11412-00	REC63V-11422-00	REC63V-11432-00	REC63V-11442-00
9.9F WH	2000	REC63V-11412-00	REC63V-11422-00	REC63V-11432-00	REC63V-11442-00
9.9F WHL/S	2001	REC63V-11412-00	REC63V-11422-00	REC63V-11432-00	REC63V-11442-00
13.5A	1999-06	REC63V-11412-00	REC63V-11422-00	REC63V-11432-00	REC63V-11442-00
15D	1985-87	REC682-11412-00	REC682-11422-00	REC63V-11432-00	REC682-11442-00
15D	1988-95	REC682-11412-00		REC6K4-11432-00	REC682-11442-00
15F/MH	1995-14	REC63V-11412-00	REC63V-11412-00	REC63V-11432-00	REC63V-11442-00
E15D	2003	REC63V-11412-00	REC63V-11422-00	REC63V-11432-00	REC63V-11442-00
15F WCL	2001-03	REC63V-11412-00	REC63V-11422-00	REC63V-11432-00	REC63V-11442-00
15 WCS	2001-02	REC63V-11412-00	REC63V-11422-00	REC63V-11432-00	REC63V-11442-00
20C	1981-86	REC6G0-11412-00	REC6G0-11422-00		
20C	1996-02		REC6G0-11422-00		
20C M	1990-02	REC6G0-11412-00	REC6G0-11422-00		
25D	1985-87	REC6G0-11412-00	REC6G0-11422-00		
25D M	1990-97	REC6G0-11412-00	REC6G0-11422-00		
25D MH	1998	REC6G0-11412-00	REC6G0-11422-00		
25D MHL/MHS	2001	REC6G0-11412-00	REC6G0-11422-00		
40X/E40X/MH	1998-02	REC66T-11412-00		REC66T-11432-00	REC66T-11442-00
40X MHL / MHS	2001-13	REC66T-11412-00		REC66T-11432-00	REC66T-11442-00
40X W	2000	REC66T-11412-00		REC66T-11432-00	REC66T-11442-00
40X WL/WS / WTL	2001-03	REC66T-11412-00		REC66T-11432-00	REC66T-11442-00



GUÍA CIGÜEÑAL COMPLETO

GUIDE CRANKSHAFT ASSY

2T
STROKES

2T STROKES	REF	2T STROKES	REF
80A/90AETO	1988 REC688-11411-00	115CETOL/CETOX	2001 REC6N7-11411-00
100A	1996-01 REC6N7-11411-00	130BETO	1990-01 REC6N7-11411-00
100A A ETO	2000 REC6N7-11411-00	130BETOL/BETOX	2001 REC6N7-11411-00
100A ETOL	2001 REC6N7-11411-00	L130B	1991-98 REC6N7-11411-00
115B ETO	1997-00 REC6N7-11411-00	L130B ETO	2000 REC6N7-11411-00
115B ETOL	2001-02 REC6N7-11411-00	L130B ETOX	2001 REC6N7-11411-00
115CEO	1990-98 REC6N7-11411-00	DX150TLRA	2002 REC67H-11411-00
115C ETO	1995-01 REC6N7-11411-00	SX150TXRA	2002 REC67H-11411-00

GUÍA RODAMIENTOS DE MOTOR

GUIDE ENGINE BEARING

2T
STROKES

		1	2	3	4	5
4A	1985-87	REC93306-304U0		REC93306-304U0	REC93310-112V0	REC93310-418V1
4AC	1987-99	REC93306-304U0		REC93306-304U0	REC93310-112V0	REC93310-418V1
4AC MHL/MHS	2001-03	REC93306-304U0		REC93306-304U0	REC93310-112V0	REC93310-418V1
4AS	1987-96	REC93306-304U0		REC93306-304U0	REC93310-112V0	REC93310-418V1
4BC	1998-99	REC93306-304U0		REC93306-304U0	REC93310-112V0	REC93310-418V1
4BC MHL/MHS	2001-03	REC93306-304U0		REC93306-304U0	REC93310-112V0	REC93310-418V1
5C	1985-99	REC93306-304U0		REC93306-304U0	REC93310-112V0	REC93310-418V1
5C MHL/MHS	2001-13	REC93306-304U0		REC93306-304U0	REC93310-112V0	REC93310-418V1
5CS	1987-96	REC93306-304U0		REC93306-304U0	REC93310-112V0	REC93310-418V1
6C	1990	REC93306-204U0	REC93306-204U0	REC93306-204U0	REC93310-112V0	REC93310-418V1
6C	1990-02	REC93306-204U0	REC93306-204U0	REC93306-204U0	REC93310-112V0	REC93310-418V1
6C MHL/MHS	2001-06	REC93306-204U0	REC93306-204U0	REC93306-204U0	REC93310-112V0	REC93310-418V1
6C WHL/WHS	2001	REC93306-204U0	REC93306-204U0	REC93306-204U0	REC93310-112V0	REC93310-418V1
6C	1990	REC93306-204U0	REC93306-204U0	REC93306-204U0	REC93310-112V0	REC93310-418V1
6D	1990-98	REC93306-204U0	REC93306-204U0	REC93306-204U0	REC93310-112V0	REC93310-418V1
6D MHL/MHS	2001-06	REC93306-204U0	REC93306-204U0	REC93306-204U0	REC93310-112V0	REC93310-418V1
6D WHS	2001	REC93306-204U0	REC93306-204U0	REC93306-204U0	REC93310-112V0	REC93310-418V1
8C	1987-02	REC93306-204U0	REC93306-204U0	REC93306-204U0	REC93310-112V0	REC93310-418V1
8C MHL/MHS	2001-12	REC93306-204U0	REC93306-204U0	REC93306-204U0	REC93310-112V0	REC93310-418V1
8C MHX/WHL	2001-03	REC93306-204U0	REC93306-204U0	REC93306-204U0	REC93310-112V0	REC93310-418V1
E8D/MH	1996-99	REC93306-204U0	REC93306-204U0	REC93306-204U0	REC93602-14118	REC93310-418U0
9.9D	1985-95	REC93306-205U2	REC93304-205U0	REC93306-304U0	REC93602-14104	REC93310-620V5

		1	2	3	4	5
9.9D	1990-95	REC93306-205U2	REC93304-205U0	REC93306-304U0	REC93602-14104	
9.9F	1995-99	REC93306-205U7	REC93306-205U7	REC93306-205U7	REC93602-14104	REC93310-620V5
9.9F MH	2000	REC93306-205U7	REC93306-205U7	REC93306-205U7	REC93602-14104	REC93310-620V5
9.9F MHL/MHS	2001-06	REC93306-205U7	REC93306-205U7	REC93306-205U7	REC93602-14104	REC93310-620V5
9.9F WC/WH	2000	REC93306-205U7	REC93306-205U7	REC93306-205U7	REC93602-14104	REC93310-620V5
9.9F WHL/WH	2001	REC93306-205U7	REC93306-205U7	REC93306-205U7	REC93602-14104	REC93310-620V5
13.5A	1999	REC93306-205U7	REC93306-205U7	REC93306-205U7	REC93602-14104	REC93310-620V5
13.5A MH	2000	REC93306-205U7	REC93306-205U7	REC93306-205U7	REC93602-14104	REC93310-620V5
13.5A MHL/MHS	2001-04	REC93306-205U7	REC93306-205U7	REC93306-205U7	REC93602-14104	REC93310-620V5
13.5A WH	2000	REC93306-205U7	REC93306-205U7	REC93306-205U7	REC93602-14104	REC93310-620V5
15D	1985-89	REC93306-205U2	REC93304-205U0	REC93306-304U0	REC93602-14104	REC93310-620V5
15D	1990-95	REC93306-205U2	REC93304-205U0	REC93306-304U0	REC93602-14104	REC93310-620V5
15F	1995-99	REC93306-205U7	REC93306-205U7	REC93306-205U7	REC93602-14104	REC93310-620V5
15F MH	2000	REC93306-205U7	REC93306-205U7	REC93306-205U7	REC93602-14104	REC93310-620V5
15F MHL/MHS	2001-06	REC93306-205U7	REC93306-205U7	REC93306-205U7	REC93602-14104	REC93310-620V5
15F WC	2000	REC93306-205U7	REC93306-205U7	REC93306-205U7	REC93602-14104	REC93310-620V5
15F WCL/WCS	2001-03	REC93306-205U7	REC93306-205U7	REC93306-205U7	REC93602-14104	REC93310-620V5
20C	1985-93	REC93306-30510		REC93306-30510	REC93602-20M02	REC93310-522W0
20C M	1990-97	REC93306-305U3		REC93306-305U3	REC93602-20M02	REC93310-522W0
20C MH	1998	REC93306-305U3		REC93306-305U3	REC93602-20M02	REC93310-522W0
20C MHL/MHS	2001-02	REC93306-305U3		REC93306-305U3	REC93602-20M02	REC93310-522W0
20DEM	1994-98	REC93311-632U7	REC93306-305U3	REC93306-305U3		
20D MHOL/MHOS	2001-06	REC93311-632U7	REC93306-305U3	REC93306-305U3		
20D WOL/WOS	2006	REC93311-632U7	REC93306-305U3	REC93306-305U3		
25B	1994-95	REC93311-636U6		REC93306-306V1	REC93603-18M09	REC93603-18M09
25B MHL/MHS	2001-06	REC93399-99951		REC93306-305U3	REC93602-20M02	
25B WCS	2001-02	REC93399-99951		REC93306-305U3	REC93602-20M02	
25D	1985-87	REC93306-30510		REC93306-30510	REC93602-20M02	REC93310-522W0
25D M	1990-97	REC93311-632U7	REC93306-305U3	REC93306-305U3	REC93602-20M02	REC93310-522W0
25D MH	1998	REC93311-632U7	REC93306-305U3	REC93306-305U3		REC93310-522W0
25D MHL/MHS	2001	REC93311-632U7	REC93306-305U3	REC93306-305U3	REC93602-20M02	REC93310-522W0
25J	1987-00			REC93306-305U3		
25J	1992-00	REC93311-632U7		REC93306-305U3		
25N	1994-98	REC93311-632U7	REC93306-305U3	REC93306-305U3		
25N MHOL/MHOS	2001-06	REC93311-632U7	REC93306-305U3	REC93306-305U3		
25N WOL/WOS	2001-03	REC93311-632U7	REC93306-305U3	REC93306-305U3		
25V	1996	REC93311-632U7	REC93306-305U3	REC93306-305U3	REC93602-20M02	
25V	1997-98	REC93311-632V4	REC93306-305U3	REC93306-305U3	REC93602-20M02	REC93310-624U5
25V MHL/MHS	2001	REC93311-632V4	REC93306-305U3	REC93306-305U3	REC93602-20M02	REC93310-624U5
25V WCS	2001	REC93311-632V4	REC93306-305U3	REC93306-305U3	REC93602-20M02	REC93310-624U5
30A	1985			REC93306-30510	REC93602-20M02	REC93310-624U5
30A M	1990-92			REC93306-305U3	REC93602-20M02	REC93310-624U5
30D	1986-99			REC93306-305U3		
30D	1992-00	REC93311-632U7		REC93306-305U3		
30D EOL/ETOL	2001-06	REC93311-632U7		REC93306-305U3		
30D MHOL/MHOS	2001-06	REC93311-632U7		REC93306-305U3		
30D QL	2001-03	REC93311-632U7		REC93306-305U3		
30D EOS	2001-06	REC93311-632U7		REC93306-305U3		
30G	1996	REC93311-632U7		REC93306-305U3	REC93602-20M02	REC93310-624U5
30G	1996-98	REC93311-632V4		REC93306-305U3	REC93602-20M02	REC93310-624U5
30G MHS/WCS	2001	REC93311-632V4		REC93306-305U3	REC93602-20M02	REC93310-624U5
30H MHS	2001-03	REC93311-632V4		REC93306-305U3	REC93602-20M02	REC93310-624U5
30H WCS	2001-02	REC93311-632V4		REC93306-305U3	REC93602-20M02	
40H	1984-87	REC93306-305U8		REC93306-30510	REC93602-20M02	
40Q	1993-98			REC93306-206U4	REC93603-21111	REC93310-730V6
40Q E/M	1992			REC93306-206U4	REC93603-21111	REC93310-730V6
40R MHO	2000				REC93602-20M02	
40R ROS	2001				REC93602-20M02	
40V	1994-99	REC93306-305U8		REC93306-305U8	REC93602-20M02	
40V EO	2000	REC93306-305U8		REC93306-305U8	REC93602-20M02	
40V EOL/EOS	2001-06	REC93306-305U8		REC93306-305U8	REC93602-20M02	
40V ETO	2000	REC93306-305U8		REC93306-305U8	REC93602-20M02	
40V ETOL/ETOS	2001-03	REC93306-305U8		REC93306-305U8	REC93602-20M02	
40V MHOL/MHOS	2001-06	REC93306-305U8		REC93306-305U8	REC93602-20M02	
40V MO	2000	REC93306-305U8		REC93306-305U8	REC93602-20M02	
40V MOS	2002-05	REC93306-305U8		REC93306-305U8	REC93602-20M02	
40X	1998	REC93306-307U0	REC93332-000UE	REC93306-306V5	REC93603-21111	REC93310-727U0
40X MH	2000	REC93306-307U0	REC93332-000UE	REC93306-306V5	REC93603-21111	REC93310-727U0
40X MHL	2001-06	REC93306-307U0	REC93332-000UE	REC93306-306V5	REC93603-21111	REC93310-727U0
40X WL/WS	2001	REC93306-307U0	REC93332-000UE	REC93306-306V5	REC93603-21111	REC93310-727U0
40X WT	2000	REC93306-307U0	REC93332-000UE	REC93306-306V5	REC93603-21111	REC93310-727U0
40X WTL	2001-03	REC93306-307U0	REC93332-000UE	REC93306-306V5	REC93603-21111	REC93310-727U0
40Y ETOL	2001-06	REC93306-305U8		REC93306-305U8	REC93602-20M02	
40Y MHOS	2001-06	REC93306-305U8		REC93306-305U8	REC93602-20M02	
E40G, E40J	2003	REC93306-307U0	REC93332-000UE	REC93306-306V1	REC93603-21111	REC93310-727V7
50D	1984-90	REC93306-305U8		REC93306-30510	REC93602-20M02	
50G	1993-98	REC93311-636U6		REC93306-306V1	REC93603-18M09	REC93310-522W0
50G ETO	2000	REC93311-636U6		REC93306-306V1	REC93603-18M09	REC93310-522W0
50G ETOL	2001-06	REC93311-636U6		REC93306-306V1	REC93603-18M09	REC93310-522W0
50H	1994-99	REC93306-305U8		REC93306-305U8	REC93602-20M02	REC93310-522W0
50H EDO	2000	REC93306-305U8		REC93306-305U8	REC93602-20M02	REC93310-522W0
50H EDOL/EDOS	2001-02	REC93306-305U8		REC93306-305U8	REC93602-20M02	REC93310-522W0
50H MDO/MO	2000	REC93306-305U8		REC93306-305U8	REC93602-20M02	REC93310-522W0
55B	1993-98	REC93311-632U1		REC93306-206U4	REC93603-21111	
55B E	1990-00	REC93311-632U1		REC93306-206U4	REC93603-21111	
55B EHD/ET	2000	REC93311-632U1		REC93306-206U4	REC93603-21111	
55B ETL	2001-02	REC93311-632U1		REC93306-206U4	REC93603-21111	
60F	1984-98	REC93311-636U6		REC93306-306V1	REC93603-18M09	
60F EO/ETO	2000	REC93311-636U6		REC93306-306V1	REC93603-18M09	

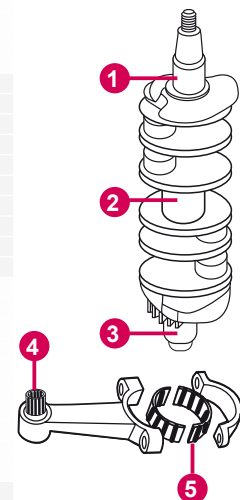

YAMAHA

RECMAR®

		1	2	3	4	5
Z200 N ETOL	2000	REC93311-940U3	REC93310-954U1	REC93306-208U0	REC93310-32337	
Z200N ETOX/ETOL	2001-06	REC93311-940U3	REC93310-954U1	REC93306-208U0	REC93310-32337	
220A	2003-06	REC93311-940U3	REC93310-954U1	REC93306-208U0	REC93310-32337	
225A	1984-86	REC93311-940U3	REC93310-954U1	REC93306-208U0	REC93603-21111	REC93310-836V2
225A	1987-89	REC93311-940U3	REC93310-954U1	REC93306-208U0	REC93603-21111	REC93310-836V2
225D ETO	2000	REC93311-940U3	REC93310-954U1	REC93306-208U0	REC93310-32337	REC93310-836V2
225D ETOX/ETOX	2001-03	REC93311-940U3	REC93310-954U1	REC93306-208U0	REC93310-32337	REC93310-836V2
225A	1984-86	REC93311-940U3	REC93310-954U1	REC93306-208U0	REC93603-21111	REC93310-836V2
225A	1987-89	REC93311-940U3	REC93310-954U1	REC93306-208U0	REC93603-21111	REC93310-836V2
225D ETO	2000	REC93311-940U3	REC93310-954U1	REC93306-208U0	REC93310-32337	REC93310-836V2
225D ETOX/ETOX	2001-03	REC93311-940U3	REC93310-954U1	REC93306-208U0	REC93310-32337	REC93310-836V2

GUÍA DE BIELAS

GUIDE CONNECTING ROAD

		1	2	3	4	5
2B	1986-02					REC90209-18112
4A	1985-87	REC6E0-11651-01	REC6G1-11633-00		REC6G1-11681-00	
4AC	1987-99	REC6E0-11651-01	REC6G1-11633-00		REC6G1-11681-00	REC90209-18112
4AC MHL/HS	2001-03	REC6E0-11651-01	REC6G1-11633-00		REC6G1-11681-00	REC90209-18112
4AS	1987-96	REC6E0-11651-01	REC6G1-11633-00		REC6G1-11681-00	REC90209-18112
4BC	1998-99	REC6E0-11651-01	REC6G1-11633-00		REC6G1-11681-00	REC90209-18112
4BC MHL/HS	2001-03	REC6E0-11651-01	REC6G1-11633-00		REC6G1-11681-00	REC90209-18112
5C	1985-99	REC6E0-11651-01	REC6G1-11633-00		REC6G1-11681-00	REC90209-18112
5C MHL/MHS	2001-06	REC6E0-11651-01	REC6G1-11633-00	REC90201-12565	REC6G1-11681-00	REC90209-18112
5CS	1987-96	REC650-11651-04	REC634-11633-00	REC90201-14377	REC682-11681-00	REC90209-20159
6C	1990-98		REC634-11633-00	REC90201-14377	REC682-11681-00	REC90209-20159
6C MHL/HS	2001-06		REC634-11633-00	REC90201-14377	REC682-11681-00	REC90209-18112
6C WHL/HS	2001		REC634-11633-00	REC90201-14377	REC682-11681-00	REC90209-18112
6D	1990-98		REC634-11633-00	REC90201-14377	REC682-11681-00	REC90209-18112
6D MHL/HS	2001-06		REC634-11633-00	REC90201-14377	REC682-11681-00	REC90209-18112
6D WHS	2001		REC634-11633-00	REC90201-14377	REC682-11681-00	REC90209-18112
8C	1990-98	REC677-11651-00	REC634-11633-00	REC90201-14377	REC682-11681-00	REC90209-18112
8C MHL/HS	2001-06	REC677-11651-00	REC634-11633-00	REC90201-14377	REC682-11681-00	REC90209-20159
8C MHX	2001-03	REC677-11651-00	REC634-11633-00	REC90201-14377	REC682-11681-00	REC90209-20159
8C WHL7HS	2001-02	REC677-11651-00	REC634-11633-00	REC90201-14377	REC682-11681-00	REC90209-20159
E8D	1997-98	REC6E0-11651-01	REC634-11633-00	REC90201-14377	REC682-11681-00	REC90209-18112
E8D MH	1999	REC6E0-11651-01	REC634-11633-00	REC90201-14377	REC682-11681-00	REC90209-18112
9.9D	1985-89	REC650-11651-04	REC634-11633-00	REC90201-14377	REC682-11681-00	
9.9D	1985-95		REC634-11633-00	REC90201-14377	REC682-11681-00	
9.9D	1990-95		REC634-11633-00	REC90201-14377	REC648-11681-00	REC90209-20159
9.9F	1995-99	REC648-11651-00	REC648-11633-00	REC90201-14377	REC682-11681-00	REC90209-20159
9.9F MH	2000	REC648-11651-00	REC648-11633-00	REC90201-14377	REC682-11681-00	REC90209-20159
9.9F MHL	2001-06	REC648-11651-00	REC648-11633-00	REC90201-14377	REC682-11681-00	REC90209-20159
9.9F MHS	2001-06	REC648-11651-00	REC648-11633-00	REC90201-14377	REC682-11681-00	REC90209-20159
9.9F WC	2000	REC648-11651-00	REC648-11633-00		REC682-11681-00	
9.9F WH	2000	REC689-11651-00	REC689-11633-00		REC689-11681-00	REC90209-24M03
9.9F WHL/HS	2001	REC689-11651-00	REC689-11633-00		REC689-11681-00	REC90209-24M03
13.5A	1999	REC689-11651-00	REC689-11633-00		REC689-11681-00	REC90209-24M03
13.5A MH	2000	REC689-11651-00	REC689-11633-00		REC689-11681-00	REC90209-24M03
13.5A MHL	2001-04	REC689-11651-00	REC689-11633-00		REC689-11681-00	REC90209-24M03
13.5A MHS	2001-04	REC689-11651-00	REC648-11633-00	REC90201-14377	REC648-11681-00	
13.5A WH	2000	REC648-11651-00	REC648-11633-00	REC90201-14377	REC648-11681-00	
15D	1985-95	REC648-11651-00	REC648-11633-00	REC90201-14377	REC648-11681-00	
15D	1990-95	REC648-11651-00	REC648-11633-00	REC90201-14377	REC648-11681-00	
15F	1995-99	REC648-11651-00	REC689-11633-00		REC689-11681-00	REC90209-24M03
15F MH	2000	REC689-11651-00	REC689-11633-00		REC689-11681-00	REC90209-24M03
15F MHL/HS	2001-06	REC689-11651-00	REC689-11633-00		REC689-11681-00	REC90209-24M03
13.5A MHL	2000-04	REC689-11651-00	REC689-11633-00		REC689-11681-00	REC90209-24M03
13.5A MHS	2001-04	REC689-11651-00	REC648-11633-00	REC90201-14377	REC648-11681-00	
13.5A WH	2000	REC648-11651-00	REC648-11633-00	REC90201-14377	REC648-11681-00	
15D	1985-89	REC648-11651-00	REC648-11633-00	REC90201-14377	REC648-11681-00	
15D	1985-95	REC648-11651-00	REC648-11633-00	REC90201-14377	REC648-11681-00	
15D	1990-95	REC648-11651-00	REC648-11633-00	REC90201-14377	REC648-11681-00	
15F	1995-99	REC648-11651-00	REC689-11633-00		REC689-11681-00	REC90209-24M03
15F MH	2000	REC689-11651-00	REC689-11633-00		REC689-11681-00	REC90209-24M03
15F MHL/HS	2001-06	REC689-11651-00	REC689-11633-00		REC689-11681-00	REC90209-24M03
15F WC	2000	REC689-11651-00	REC689-11633-00		REC689-11681-00	REC90209-24M03
15F WCL	2001-03	REC689-11651-00	REC689-11633-00		REC689-11681-00	REC90209-24M03
15F WCS	2001-02	REC689-11651-00	REC689-11633-00		REC689-11681-00	REC90209-24M03
20C	1985-93	REC689-11651-00	REC689-11633-00		REC689-11681-00	REC90209-24M03
20C	1986-02	REC648-11651-00	REC648-11633-00	REC90201-20417	REC648-11681-00	
20C	1993	REC6F5-11651-00	REC6F5-11633-00	REC90201-20417	REC66T-11681-00	REC90209-27M07
20C M	1990-97	REC6F5-11651-00	REC6F5-11633-00	REC90201-20417	REC66T-11681-00	REC90209-27M07
20C MH	1998	REC6F5-11651-00	REC6F5-11633-00	REC90201-20417	REC66T-11681-00	REC90209-27M07
20C MHL, MHS	2001-02	REC6F5-11651-00	REC6F5-11633-00	REC90201-20417	REC66T-11681-00	REC90209-27M07

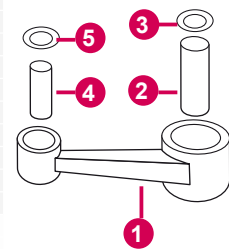

		1	2	3	4	5
20D	1994-98	REC6F5-11651-00	REC6F5-11633-00	REC90201-20417	REC66T-11681-00	REC90209-27M07
20D MHOL, MHOS	2001-06	REC6F5-11651-00	REC6F5-11633-00	REC90201-20417	REC66T-11681-00	REC90209-27M07
20D WOL/OS	2006	REC6F5-11651-00	REC6F5-11633-00	REC90201-20417	REC66T-11681-00	REC90209-27M07
25B	1994-02	REC689-11651-00	REC663-11633-00	REC90201-20417	REC689-11681-00	REC90209-24M03
25B MHL/HS	2001-06	REC689-11651-00	REC663-11633-00	REC90201-20417	REC689-11681-00	REC90209-24M03
25B WCS	2001-02	REC689-11651-00	REC663-11633-00	REC90201-20417	REC689-11681-00	REC90209-24M03
25D	1985-01	REC648-11651-00	REC663-11633-00	REC90201-20417	REC648-11681-00	
25D	1986-87	REC648-11651-00	REC663-11633-00	REC90201-20417	REC648-11681-00	
25D M	1990-97	REC648-11651-00	REC663-11633-00	REC90201-20417		
25D MH	1998	REC648-11651-00				
25D MHL/S	2001	REC648-11651-00				
25N	1994-98		REC6H3-11633-00	REC90201-20417		
25N MHOL/S	2001-06	REC689-11651-00	REC663-11633-00	REC90201-20417		
25N WOL/WOS	2001-03	REC689-11651-00	REC663-11633-00	REC90201-20417		
25V	1996-98	REC689-11651-00	REC663-11633-00	REC90201-20417	REC689-11681-00	REC90209-24M03
25V MHL/HS	2001	REC689-11651-00	REC663-11633-00	REC90201-20417	REC689-11681-00	REC90209-24M03
25V WCS	2001	REC689-11651-00	REC663-11633-00	REC90201-20417	REC689-11681-00	REC90209-24M03
30A	1985	REC689-11651-00	REC663-11633-00	REC90201-20417	REC689-11681-00	REC90209-24M03
30A M	1990-92	REC689-11651-00	REC663-11633-00	REC90201-20417	REC689-11681-00	REC90209-24M03
30D	1986-00	REC689-11651-00	REC663-11633-00	REC90201-20417		
30D EOL/EOS/ ETOL	2001-06	REC689-11651-00	REC663-11633-00	REC90201-20417		
30D MHOL	2001-06	REC689-11651-00	REC663-11633-00	REC90201-20417		
30D MHOS	2001-05	REC689-11651-00	REC663-11633-00	REC90201-20417		
30D OL	2001-03	REC689-11651-00	REC663-11633-00	REC90201-20417		
30D EOS	2001-06		REC6R5-11633-00	REC90201-23M01		
40G/J	1986-89	REC6F5-11651-00	REC6F5-11633-00		REC6F5-11681-00	REC90209-27M07
40R ROS	2001		REC6R5-11633-00	REC90201-23M01		
40V	1994-99	REC6H4-11651-00	REC6R5-11633-00	REC90201-23M01		
40V EO	2000	REC6E5-11651-00	REC6R5-11633-00	REC90201-23M01		
40V EOL/EOS	2001-06		REC6R5-11633-00	REC90201-23M01		
40V ETO	2000	REC6E5-11651-00				
40V ETOL/S	2001-03	REC6E5-11651-00				
40V MHOL	2001-06	REC6E5-11651-00				
40V MHOS	2001-06		REC6R5-11633-00	REC90201-23M01		
40V MO	2000		REC6R5-11633-00	REC90201-23M01		
40V MOS	2002-05		REC6R5-11633-00	REC90201-23M01		
40X	1998	REC6F5-11651-00	REC6F5-11633-00	REC90201-23M01	REC66T-11681-00	REC90209-27M07
40X MH	2000	REC6F5-11651-00	REC6F5-11633-00	REC90201-23M01	REC66T-11681-00	REC90209-27M07
40X MHL	2001-06	REC6F5-11651-00	REC6F5-11633-00	REC90201-23M01	REC66T-11681-00	REC90209-27M07
40 MHS	2001-02	REC6F5-11651-00	REC6F5-11633-00	REC90201-23M01	REC66T-11681-00	REC90209-27M07
40X W	2000	REC6F5-11651-00	REC6F5-11633-00	REC90201-23M01	REC66T-11681-00	REC90209-27M07
40X WL	2001	REC6F5-11651-00	REC6F5-11633-00	REC90201-23M01	REC66T-11681-00	REC90209-27M07
40X WS	2001	REC6E5-11651-00	REC6F5-11633-00	REC90201-23M01	REC66T-11681-00	REC90209-27M07
40X WT	2000	REC6E5-11651-00	REC6F5-11633-00	REC90201-23M01	REC66T-11681-00	REC90209-27M07
40X WTL	2001-03		REC6F5-11633-00	REC90201-23M01	REC66T-11681-00	REC90209-27M07
40Y ETOL, MHOS	2001-06		REC6R5-11633-00	REC90201-23M01		
40GM,W,J	2003-04	REC6F5-11651-00	REC6F5-11633-00	REC90209-27M07	REC6F5-11681-00	REC90209-27M07
50D	1984-87		REC6R5-11633-00	REC90201-23M01		
50G	1993-98	REC6H4-11651-00	REC648-11633-00		REC6G0-11681-00	REC90209-24M03
50G ETO	2000	REC6E5-11651-00	REC648-11633-00	REC90201-23M01	REC6G0-11681-00	REC90209-24M03
50G ETOL	2001-06		REC648-11633-00	REC90201-23M01	REC6G0-11681-00	REC90209-24M03
50H	1994-99	REC6H4-11651-00	REC648-11633-00	REC90201-23M01	REC6G0-11681-00	REC90209-24M03
50H EDO	2000	REC6H4-11651-00	REC648-11633-00	REC90201-23M01	REC6G0-11681-00	REC90209-24M03
50H EDOL	2001-02	REC6H4-11651-00	REC648-11633-00	REC90201-23M01	REC6G0-11681-00	REC90209-24M03
50H EDOS	2001-02	REC6E5-11651-00	REC648-11633-00		REC6G0-11681-00	REC90209-24M03
50H MDO	2000	REC6E5-11651-00	REC648-11633-00	REC90201-23M01	REC6G0-11681-00	REC90209-24M03
50H MO	2000		REC648-11633-00	REC90201-23M01	REC6G0-11681-00	REC90209-24M03
55B	1993-98	REC688-11651-00	REC6R5-11633-00	REC90201-23M01		
70B ETOL	2001-06	REC6E5-11651-00	REC6R5-11633-00	REC90201-23M01		
75A	1993-98	REC688-11651-00	REC6R5-11633-00	REC90201-23M01		
75A E	1990-00	REC688-11651-00	REC6R5-11633-00	REC90201-23M01		
75A EDL	2001-06	REC688-11651-00	REC6R5-11633-00	REC90201-23M01		
75A EM	1992	REC688-11651-00	REC6R5-11633-00	REC90201-23M01		
75A ET	2000	REC688-11651-00				
75A ETL	2001-02	REC688-11651-00				
75A MHD	2000	REC688-11651-00				
75C	1998	REC688-11651-00				
75C ETO	2000	REC688-11651-00				
75C ETOL	2001-06	REC688-11651-00				
80A	1985-96	REC688-11651-00				
85A	1996-98	REC688-11651-00				
85A E	1990-00	REC688-11651-00				
85A ET	2000	REC688-11651-00				
85A ETL	2001-02	REC688-11651-00				
90A	1984-98	REC688-11651-00				
90A ETO	2000-00	REC688-11651-00				
90A ETOL	2001-06	REC688-11651-00				
V4-V6		REC6E5-11651-00				

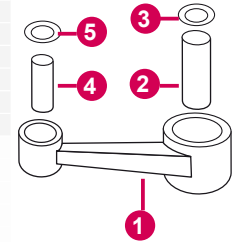

**1****2****3****4****5**

E60 ELHB	2003			REC6K5-11681-00
E60HMHD	2003			REC6K5-11681-00
115 B	1988-90	REC6K7-11633-00		
115BE-T	1991-92	REC6K7-11633-00		
140 BETO	1988-89	REC6K7-11633-00		
150 AETO	1988-89	REC6K7-11633-00		
200-225 BETO	1990-92	REC6K7-11633-00		
175 BETO	1990-92	REC6K7-11633-00		

ARANDELA SEPARACIÓN BIELA**CONNECTING ROD, WHASER**

REF	OEM
REC90209-22248-00	90209-22248-00

**COJINETE BIELA****CONNECTING ROD, BEARING**

REF	OEM
REC93310-418U1	93310-418U1

**BIELA****CONNECTING ROD**

REF	OEM
REC6K5-11651-00	6K1-11651-00

**SELLO****SEAL OIL**

REF	OEM	
REC656-11515-00	656-11515-00	20C/25D



REF	OEM	
REC689-11515-00	689-11515-00	30A









PISTONES

PISTON

2T
STROKES

KITS DE PISTONES







La gama de pistones RECMAR®, se suministrará siempre como kit, compuesto por pistón, aros, bulón y clips. Eventualmente las referencias antiguas sufren cambios de numeración. En caso de duda contacten con nuestros técnicos comerciales.

	STD Ø 50mm	
	REF	OEM
	REC6E0-11631-00-98K	6E0-11631-00-98
	REC6G1-11610-00	6G1-11610-00
	REC6G1-11633-00	6G1-11633-00
	REC93310-112V0	93310-112V0
	REC93450-13022	93450-13022
	4AC (1985-02), 4AS (1987-96) 5C (1994-98), 5CS (1994-96)	









PISTON KITS





The RECMAR® piston assortment is always supplied as a set (piston, rings, pins and bearings). Old references may change. In case of any doubt contact our technicians.

	STD Ø 50mm		0.25		0.50	
	REF	OEM	REF	OEM	REF	OEM
	REC677-11631-00K 677-11631-00-97		REC677-11635-00K 677-11635-00		REC677-11636-00K 677-11636-00	
	REC647-11610-00	647-11610-00				
	REC6G1-11633-00	6G1-11633-00	REC6G1-11633-00	6G1-11633-00	REC6G1-11633-00	6G1-11633-00
	REC93602-14118	93602-14118	REC93602-14118	93602-14118	REC93602-14118	93602-14118
	REC93450-13022	93450-13022	REC93450-13022	93450-13022	REC93450-13022	93450-13022
	E8D (1997-99) E8DMH (1998-03)					









	STD Ø 56mm		0.25		0.50	
	REF	OEM	REF	OEM	REF	OEM
	REC6E7-11631-00K 6E7-11631-00		REC6E7-11635-00K 6E7-11635-00		REC6E7-11636-00K 6E7-11636-00	
	REC682-11610-01	682-11610-00	REC682-11610-11	682-11610-11	REC682-11610-21	682-11610-21
	REC634-11633-00	634-11633-00	REC634-11633-00	634-11633-00	REC634-11633-00	634-11633-00
	REC93602-14104	93602-14104	REC93602-14104	93602-14104	REC93602-14104	93602-14104
	REC93450-15023	93450-15023	REC93450-15023	93450-15023	REC93450-15023	93450-15023
	9.9D/15D (1985-95), 9.9F/FMH/MSH (1995-14) 15F/FEM/MSH/FMH/MH (1995-14)					









	STD Ø 72mm		0.25		0.50	
	REF	OEM	REF	OEM	REF	OEM
	REC6H3-11631-01K 6H3-11631-01-96		REC6H3-11635-01K 6H3-11635-01		REC6H3-11636-01K 6H3-11636-01	
	REC6K5-11601-02	6K5-11601-02	REC6K5-11601-12	6K5-11601-12	REC6K5-11601-22	6K5-11601-22
	REC6H3-11633-00	6H3-11633-00	REC6H3-11633-00	6H3-11633-00	REC6H3-11633-00	6H3-11633-00
	REC93603-18M09	93603-18M09	REC93603-18M09	93603-18M09	REC93603-18M09	93603-18M09
	25B/BETO (1994-95), 50G/GEO/GETO (1993-07) 60F/FEO/FEDO/FETO/FEH/TR/TLR (1990-07) 70BEH/BEO/B/BEM/BETO/BEDO/TR (1990-13)					









	STD Ø 72mm		0.25		0.50	
	REF	OEM	REF	OEM	REF	OEM
	REC61N-11631-00K 61N-11631-00-95		REC61N-11635-00K 61N-11635-00		REC61N-11636-00K 61N-11636-00	
	REC61N-11603-00	61N-11603-00	REC61N-11604-00	61N-11604-00	REC61N-11605-00	61N-11605-00
	REC689-11633-00	689-11633-00	REC689-11633-00	689-11633-00	REC689-11633-00	689-11633-00
	REC93602-20M02	93602-20M02	REC93602-20M02	93602-20M02	REC93602-20M02	93602-20M02
	REC688-11634-00	688-11634-00	REC688-11634-00	688-11634-00	REC688-11634-00	688-11634-00
	25VE/VM (1996-01), 25B/BMH (2001-10) 30G/GE (1996-00) E30HMH(2003), E30HMH/HW (2003-12)					





	STD Ø 67mm		0.25		0.50	
	REF	OEM	REF	OEM	REF	OEM
	REC6H4-11631-01K	6H4-11631-01-95	REC6H4-11635-01K	6H4-11635-01	REC6H4-11636-01K	6H4-11636-01
	REC63D-11603-00	63D-11603-00			REC63D-11605-00	63D-11605-00
	REC648-11633-00	648-11633-00	REC648-11633-00	648-11633-00	REC648-11633-00	648-11633-00
	REC93602-20M02	93602-20M02	REC93602-20M02	93602-20M02	REC93602-20M02	93602-20M02
	REC6H4-11634-01	6H4-11634-01	REC6H4-11634-01	6H4-11634-01	REC6H4-11634-01	6H4-11634-01
	25Q/QEO (1990-94) 40V/VMH/VETO/VMH/MLH/VMHO/VE/VEO/TLR/VETO/YETO/H/HE (1995-13) C40T/TLR (1995-02) 50H/HRD/HMHD/HETO/HEDO/HWM/D/DE/DEMT0 (1989-03)					









	STD Ø 72mm	
	REF	OEM
	REC689-11631-00K	689-11631-00-95
	REC689-11610-00	689-11610-01
	REC689-11633-00	689-11633-00
	REC93602-20M02	93602-20M02
	REC663-11634-00	633-11634-00
	30A (1985-1992)	









	STD Ø 59mm	
	REF	OEM
	REC6J8-11631-02	6J8-11631-02-97
	25J/JEO/JETO/ESH (1990-99) 30DETO/DEO/DE/DMH/D/ELH/DWH (1990-12)	









	STD Ø 76mm		0.25		0.50	
	REF	OEM	REF	OEM	REF	OEM
	REC6F6-11631-00K	6F6-11631-00-95	REC6F6-11635-00K	6F6-11635-00	REC6F6-11636-00K	6F6-11636-00
	REC6F5-11610-00	6F5-11610-00		6F5-11610-10	REC6F5-11610-20	6F5-11610-20
	REC6F5-11633-00	6F5-11633-00	REC6F5-11633-00	6F5-11633-00	REC6F5-11633-00	6F5-11633-00
	REC93603-21111	93603-21111	REC93603-21111	93603-21111	REC93603-21111	93603-21111
	REC663-11634-00	663-11634-00	REC663-11634-00	663-11634-00	REC663-11634-00	663-11634-00
	E40GMH/JMH/JWH (2003) 40GWH/JWH (2003)					







	STD Ø 80mm		0.25		0.50	
	REF	OEM	REF	OEM	REF	OEM
	REC66T-11631-01K	66T-11631-01-93	REC66T-11635-01K	66T-11635-01	REC66T-11636-01K	66T-11636-01
	REC66T-11603-00	66T-11603-00	REC66T-11604-00	66T-11604-00	REC66T-11605-00	66T-11605-00
	REC6F5-11633-00	6F5-11633-00	REC6F5-11633-00	6F5-11633-00	REC6F5-11633-00	6F5-11633-00
	REC93603-21111	93603-21111	REC93603-21111	93603-21111	REC93603-21111	93603-21111
	REC663-11634-00	663-11634-00	REC663-11634-00	663-11634-00	REC663-11634-00	663-11634-00
	E40X/XMH/XW (2002-13) 40XMH/XW (2003-13)					



	STD Ø 67mm		0.25		0.50	
	REF	OEM	REF	OEM	REF	OEM
	REC6H4-11631-00K	6H4-11631-00-96	REC6H4-11635-00K	6H4-11635-00	REC6H4-11636-00K	6H4-11636-00
	REC6H4-11610-00-00	6H4-11610-00				
	REC648-11633-00	648-11633-00	REC648-11633-00	648-11633-00	REC648-11633-00	648-11633-00
	REC93602-20M02	93602-20M02	REC93602-20M02	93602-20M02	REC93602-20M02	93602-20M02
	REC6H4-11634-01	6H4-11634-01	REC6H4-11634-01	6H4-11634-01	REC6H4-11634-01	6H4-11634-01
	40N/E/H (1984-1988) 50D/ETN (1984-1988)					







	STD Ø 81mm		0.25		0.50	
	REF	OEM	REF	OEM	REF	OEM
	REC6H1-11631-03K	6H1-11631-03-95				
	REC688-11603-A0	688-11603-A0			REC688-11605-A0	688-11605-A0
	REC663-11633-00	663-11633-00				
	REC93603-21111	93603-21111	REC93603-21111	93603-21111	REC93603-21111	93603-21111
	55B (1996) 75 TLRB (2003), 75CETO (2004-13), 75AE/T/M/HD (1995-98) E75B (2000-02) 75AED (2003-07), 75TLR (2000-02) 80A/AETO/AEMTO (1994-02) 85A/AE (1995-02) 90A/AEO/AEMO/AETO/AET/TLR/AETO (1994-13)					









	STD Ø 82mm	
	REF	OEM
	REC688-11631-02K	688-11631-02-95
	REC688-11610-02	688-11610-02
	REC663-11633-00	663-11633-00
	REC93603-21111	93603-21111
	REC688-11634-00	688-11634-00
	55BET (1990) 55BE (1992)	







	STD	
	REF	OEM
	REC688-11631-81K	688-11631-81-96
	REC688-11610-02	688-11610-02
	REC93603-21111	93603-21111
	75A/AE (1990-93) 85A/AE (1990-93)	









	STD Ø 82mm		0.25		0.50	
	REF	OEM	REF	OEM	REF	OEM
	REC688-11631-03K	688-11631-03-94	REC688-11635-03K	688-11635-03	REC688-11636-03K	688-11635-03
	REC688-11603-A0	688-11603-A0			REC688-11605-A0	688-11605-A0
	REC663-11633-00	663-11633-00	REC663-11633-00	663-11633-00	REC663-11633-00	663-11633-00
	REC93603-21111	93603-21111	REC93603-21111	93603-21111	REC93603-21111	93603-21111
	REC688-11634-00	688-11634-00	REC688-11634-00	688-11634-00	REC688-11634-00	688-11634-00
	E48CMHS (2003), 55B/BM/BET (1993-02), 55CMH (2003-05) E75B (2000), 85A/AET/AED (2000-03)					









	STD Ø 72mm		0.25		0.50	
	REF	OEM	REF	OEM	REF	OEM
	REC6K5-11631-03K	6K5-11631-03-95	REC6K5-11635-03K	6K5-11635-03	REC6K5-11636-03K	6K5-11636-03
	REC6K5-11601-02	6K5-11601-02	REC6K5-11601-12	6K5-11601-12	REC6K5-11601-22	6K5-11601-22
	REC6H3-11633-00	6H3-11633-00	REC6H3-11633-00	6H3-11633-00	REC6H3-11633-00	6H3-11633-00
	REC93603-18M09	93603-18M09	REC93603-18M09	93603-18M09	REC93603-18M09	93603-18M09
	E60HE/HM/H/MHZ/MLHA/ELHB/HMHD -S-L (1997-13)					









	STD Ø 89mm ESTRIBOR STD		STD Ø 89mm BABOR PORT	
	REF	OEM	REF	OEM
	REC6R5-11631-11K	6R5-11631-11-93	REC6R5-11642-11K	6R5-11642-11-93
	REC6R5-11603-00	6R5-11603-00	REC6R5-11603-00	6R5-11603-00
	REC6R5-11633-00	6R5-11633-10		
	REC93310-32337	93310-32337	REC93310-32337	93310-32337
	REC6R5-11634-00	6R5-11634-10	REC6R5-11634-00	6R5-11634-10
	100A/AETO (1996-01), 115B (2000-02), 115CEO/CETO/TLR/TXRZ (1993-13) 130BETO/TLR (1993-07), 150 CETO/L150CETO (1993-95) 175BETO (1993-95), 200CETO (1993), 200BETO (1993-95) 225BET/BETO (1993-95)			



	STD Ø 89mm ESTRIBOR STD		STD Ø 89mm BABOR PORT		0.2590		0.50	
	REF	OEM	REF	OEM	REF	OEM	REF	OEM
	REC6R5-11631-01K	6R5-11631-11-93	REC6R5-11642-01K	6R5-11642-11-93				
	REC64D-11603-01	64D-11603-02	REC64D-11603-01	64D-11603-02	REC64D-11604-01	64D-11603-04	REC64D-11605-01	64D-11603-05
	REC6K7-11633-00	6K7-11633-00	REC6K7-11633-00	6K7-11633-00				
	REC93310-32337	93603-21111	REC93310-32337	93603-21111				
	REC6R5-11634-00	6R5-11634-00	REC6R5-11634-00	6R5-11634-00				
	115BE/CEO (1992), E115AEL (2003), 130BETO (1992), 150CETO (1992) 175BETO (1992), 200BETO (1992)							



	STD Ø 89mm ESTRIBOR STD		STD Ø 89mm BABOR PORT	
	REF	OEM	REF	OEM
	REC6G5-11631-00K	6G5-11631-00-93	REC6G5-11642-00K	6G5-11642-00-93
	REC6E5-11610-02	6E5-11610-02	REC6E5-11610-02	6E5-11610-02
		6E5-11633-01		6E5-11633-01
	REC93603-21111	93603-21111	REC93603-21111	93603-21111
	REC6E5-11634-00	6E5-11634-00	REC6E5-11634-00	6E5-11634-00
	115ETN (1984), 115A (1985-87), 140AETO (1984-87), 150ETN (1984), 150AETO (1985-87), 175AETO (1984-87), 200ETN (1984), 200AETO (1985-87)			



	0.25 mm		0.50 mm	
	REF	OEM	REF	OEM
	REC677-11635-00	6771163500	REC677-11636-00	6771163600



	STD ESTRIBOR STD	
	REF	OEM
	REC6D0-11631-00	6D0116310284









	0.50 mm BABOR PORT	
	REF	OEM
	REC69L-11646-00	69L-11646-00



	STD BABOR PORT	
	REF	OEM
	REC6D0-11642-00	6D0-11642-00







	STD Ø 89mm ESTRIBOR STD		STD Ø 89mm BABOR PORT	
	REF	OEM	REF	OEM
	REC64D-11631-00K64D-11631-02-90		REC64D-11642-00K64D-11642-02-90	
	REC64D-11603-01	64D-11603-02	REC64D-11603-01	64D-11603-02
	REC6R5-11633-00	6R5-11633-10	REC6R5-11633-00	6R5-11633-10
	REC93310-32337	93310-32337	REC93310-32337	93310-32337
	REC6R5-11634-00	6R5-11634-10	REC6R5-11634-00	6R5-11634-10
	150F/FETO (1996-2007), 150TXR/TR (2002-05), 150AET (2001-02) 175D/DETO (1996-03) 200AET (2003), 200F/TLR/FETO (1996-10), 200G/GETOL (1996-02) L200F/FETO (1996-00) 225D/DET (1996-09)			









2T
STROKES



GUÍA DE PISTONES Y SEGMENTOS

GUIDE
PISTON & RING

		ESTRIBOR STD		BABOR PORT	
					
4A	1985-87	REC6G1-11610-00	REC6E0-11631-00-98K		
4AC	1987-99	REC6G1-11610-00	REC6E0-11631-00-98K		
4ACMHL/HS	2001-03	REC6G1-11610-00	REC6E0-11631-00-98K		
4AS	1987-96	REC6G1-11610-00	REC6E0-11631-00-98K		
4BC	1998	REC6G1-11610-00	REC6E0-11631-00-98K		
4BCMHL/HS	2001-03	REC6G1-11610-00	REC6E0-11631-00-98K		
5C	1994-98	REC6G1-11610-00	REC6E0-11631-00-98K		
5CMHL/HS	2001-03	REC6G1-11610-00	REC6E0-11631-00-98K		
5CS	1994-96	REC6G1-11610-00	REC6E0-11631-00-98K		
6C	1984-96	REC6G1-11610-00			
6CMHL/HS	2002	REC6G1-11610-00			
6D	1984-96	REC6G1-11610-00			
6DMHL/HS	2002	REC6G1-11610-00			
8C	1984-96	REC6G1-11610-00			
8CMHL/HS/HX	2002	REC6G1-11610-00			
8CWHL/S	2002	REC6G1-11610-00			
E8D	1997-98	REC647-11610-00	REC677-11631-00K		
E8DMH	1999	REC689-11610-00	REC677-11631-00K		
9.9D	1985	REC682-11610-01	REC6E7-11631-00K		
9.9FEMHW	1995-13	REC682-11610-01	REC6E7-11631-00K		
13.5/15 FEMHW LBC	1995-13	REC682-11610-01	REC6E7-11631-00K		
15D	1985-95	REC682-11610-01	REC6E7-11631-00K		
25B/BETO	1994-95	REC6K5-11601-02	REC6H3-11631-01K		
25BMHL/HS	2001-10	REC61N-11603-00	REC61N-11631-00K		
25J	1990-00		REC6J8-11631-02		
25Q	1990-94		REC6H4-11631-01K		
25VE/VM	1996-01	REC61N-11603-00	REC61N-11631-00K		
25BMHL/HM	2001-12	REC61N-11603-00	REC61N-11631-00K		
25BMHS/WC	2001-12	REC61N-11603-00	REC61N-11631-00K		
C25 MHV2	1997-98	REC61N-11603-00	REC61N-11631-00K		
30A	1984-85	REC689-11610-00	REC689-11631-00K		
30AM	1990-92	REC689-11610-00	REC689-11631-00K		
30D	1990-02		REC6J8-11631-02		
30DEOL -EL	2001-10		REC6J8-11631-02		
30DEOS	2001-10		REC6J8-11631-02		
30DEOT -DETOL	2001-10		REC6J8-11631-02		
30DMHOL	2001-14		REC6J8-11631-02		
30DMHOS	2001-10		REC6J8-11631-02		
E30HMH	2003	REC61N-11603-00	REC61N-11631-00K		
30G/GE	1996-97	REC61N-11603-00	REC61N-11631-00K		
30 HM/WH	2003	REC61N-11603-00	REC61N-11631-00K		
30 HM/W	2010-12	REC61N-11603-00	REC61N-11631-00K		
C30	1993-97	REC61N-11603-00	REC61N-11631-00K		
40H	1984-88	REC6H4-11610-00-00	REC6H4-11631-00K		
40H	1989-94		REC6H4-11631-01K		
40RMHO	2000	REC6H4-11610-00-00	REC6H4-11631-01K		
40RROS	2001	REC6H4-11610-00-00	REC6H4-11631-01K		
40V	1995-98	REC6H4-11610-00-00	REC6H4-11631-01K		
40VEO	2000	REC6H4-11610-00-00	REC6H4-11631-01K		



		ESTRIBOR STD		BABOR PORT	
					
40VEOL/OS	2001-06	REC6H4-11610-00-00	REC6H4-11631-01K		
40VETO	2000	REC6H4-11610-00-00	REC6H4-11631-01K		
40VETOL	2001-06	REC6H4-11610-00-00	REC6H4-11631-01K		
40VETOS	2001-3	REC6H4-11610-00-00	REC6H4-11631-01K		
40VMHOL/OS	2001-06	REC6H4-11610-00-00	REC6H4-11631-01K		
40VMO	2000	REC6H4-11610-00-00	REC6H4-11631-01K		
40VMOS	2002	REC6H4-11610-00-00	REC6H4-11631-01K		
40X	1998	REC66T-11603-00	REC66T-11631-01K		
40XMH	2000	REC66T-11603-00	REC66T-11631-01K		
40XMHL	2001-06	REC66T-11603-00	REC66T-11631-01K		
40XMHS	2001-02	REC66T-11603-00	REC66T-11631-01K		
40XW	2000	REC66T-11603-00	REC66T-11631-01K		
40XWL/WS	2001	REC66T-11603-00	REC66T-11631-01K		
40XWT	2000	REC66T-11603-00	REC66T-11631-01K		
40XWTL	2001-03	REC66T-11603-00	REC66T-11631-01K		
40YETOL/ YMOS	2001-04	REC6H4-11610-00-00	REC6H4-11631-01K		
50D	1984-89	REC6H4-11610-00-00	REC6H4-11631-01K		
50D	1989-94		REC6H4-11631-01K		
50G/EO	1993-00	REC6K5-11601-02	REC6H3-11631-01K		
50GETO	2000	REC6K5-11601-02	REC6H3-11631-01K		
50GETOL	2001-07	REC6K5-11601-02	REC6H3-11631-01K		
50H	1995-98	REC6H4-11610-00-00	REC6H4-11631-01K		
50HEDO	2000	REC6H4-11610-00-00	REC6H4-11631-01K		
50HEDOL/OS	2001-02	REC6H4-11610-00-00	REC6H4-11631-01K		
50HMDO	2000	REC6H4-11610-00-00	REC6H4-11631-01K		
55B	1993-02	REC688-11603-A0	REC6H1-11631-03K		
55BE	1990-92	REC688-11610-02	REC688-11631-02K		
55BE	2000	REC688-11603-A0	REC688-11631-02K		
55BEHD/BET	2000	REC688-11603-A0	REC688-11631-02K		
55BETL	2001-02	REC688-11603-A0	REC688-11631-02K		
60F	1990-02	REC6K5-11601-02	REC6H3-11631-01K		
60FEO	1991-00	REC6K5-11601-02	REC6H3-11631-01K		
60FETO	2000-06	REC6K5-11601-02	REC6H3-11631-01K		
60FETOL	2001-07	REC6K5-11601-02	REC6H3-11631-01K		
E60/HM/HDL	2001-06	REC6K5-11601-02	REC6K5-11631-03K		
70B	1990-02	REC6K5-11601-02	REC6H3-11631-01K		
70BEDOL	2001-03	REC6K5-11601-02	REC6H3-11631-01K		
70BEO	1991-00	REC6K5-11601-02	REC6H3-11631-01K		
70BETO	1998-13	REC6K5-11601-02	REC6H3-11631-01K		
70BETOL	2001-13	REC6K5-11601-02	REC6H3-11631-01K		
75A	1993-94	REC688-11610-02	REC688-11631-81K		
75AET	2000	REC688-11603-A0	REC6H1-11631-03K		
75AETL	2001-06	REC688-11603-A0	REC6H1-11631-03K		
75AMHD	2000	REC688-11603-A0	REC6H1-11631-03K		
75C	1998	REC688-11603-A0	REC6H1-11631-03K		
75CETO	2000	REC688-11603-A0	REC6H1-11631-03K		
75CETOL	2001-06	REC688-11603-A0	REC6H1-11631-03K		
80A	1994-96	REC688-11603-A0	REC6H1-11631-03K		
85A	1990-94	REC688-11610-02	REC688-11631-81K		

		ESTRIBOR STD		BABOR PORT
85A	1995-98	REC688-11603-A0	REC6H1-11631-03K	
85AE	1990-92	REC688-11610-02	REC688-11631-81K	
85AE/AET	2000	REC688-11603-A0	REC6H1-11631-03K	
85AETL	2001-02	REC688-11603-A0	REC6H1-11631-03K	
90A	1994-98	REC688-11603-A0	REC6H1-11631-03K	
90AETO	2000	REC688-11603-A0	REC6H1-11631-03K	
90AETOL	2001-06	REC688-11603-A0	REC6H1-11631-03K	
100A	1997-98	REC64D-11603-01	REC6R5-11631-11K REC6R5-11642-11K	
100AETO	2000	REC64D-11603-01	REC6R5-11631-11K REC6R5-11642-11K	
100AETOL	2001	REC64D-11603-01	REC6R5-11631-11K REC6R5-11642-11K	
115A	1984-87	REC6E5-11610-02	REC6G5-11631-00K REC6G5-11642-00K	
115B	1992	REC61U-11601-00	REC6R5-11631-01K REC6R5-11642-01K	
115B	1993-96	REC6R5-11603-00	REC6R5-11631-11K REC6R5-11642-11K	
115BETO	1997-00	REC64D-11603-01	REC6R5-11631-11K REC6R5-11642-11K	
115BETOL	2001-02	REC64D-11603-01	REC6R5-11631-11K REC6R5-11642-11K	
115C	1992	REC64D-11603-01	REC6R5-11631-11K REC6R5-11642-11K	
115C	1993-96	REC6R5-11603-00	REC6R5-11631-11K REC6R5-11642-11K	
115C	1997-98	REC64D-11603-01	REC6R5-11631-11K REC6R5-11642-11K	
115CETO	2000	REC64D-11603-01	REC6R5-11631-11K REC6R5-11642-11K	
115CETOL	2001-06	REC64D-11603-01	REC6R5-11631-11K REC6R5-11642-11K	
115CETOX	2001	REC64D-11603-01	REC6R5-11631-11K REC6R5-11642-11K	
E115AWVEL	2003-06	REC64D-11603-01	REC6R5-11631-01K REC6R5-11642-01K	
130B	1992	REC64D-11603-01	REC6R5-11631-11K REC6R5-11642-11K	
130B	1993-96	REC6R5-11603-00	REC6R5-11631-11K REC6R5-11642-11K	
130B	1997-98	REC64D-11603-01	REC6R5-11631-11K REC6R5-11642-11K	
130BETO	2000	REC64D-11603-01	REC6R5-11631-11K REC6R5-11642-11K	
130BETOL	2001-06	REC64D-11603-01	REC6R5-11631-11K REC6R5-11642-11K	
130BETOX	2001	REC64D-11603-01	REC6R5-11631-11K REC6R5-11642-11K	
L130B	1992	REC61U-11601-00	REC6R5-11631-01K REC6R5-11642-01K	
L130B	1993	REC6R5-11603-00	REC6R5-11631-11K REC6R5-11642-11K	
L130B	1997-98	REC64D-11603-01	REC6R5-11631-11K REC6R5-11642-11K	
L130BETOX	2000-01	REC64D-11603-01	REC6R5-11631-11K REC6R5-11642-11K	
140A	1985-87	REC6E5-11610-02	REC6G5-11631-00K REC6G5-11642-00K	
150A	1984-87	REC6E5-11610-02	REC6G5-11631-00K REC6G5-11642-00K	
150AET	1998-00	REC64D-11603-01	REC64D-11631-00K	
150AETL/AETX	2001-02	REC64D-11603-01	REC64D-11642-00K	
150C	1992	REC61U-11601-00	REC6R5-11631-01K REC6R5-11642-01K	
150C	1993-05	REC6R5-11603-00	REC6R5-11631-11K REC6R5-11642-11K	
150F	1996-01	REC64D-11603-01	REC6G5-11631-00K REC6G5-11642-00K	
150FETO	1998-00	REC64D-11603-01	REC64D-11631-00K REC64D-11642-00K	
150FETOL	2001-04	REC64D-11603-01	REC64D-11631-00K REC64D-11642-00K	
150FETOX	2001-05	REC64D-11603-01	REC64D-11631-00K REC64D-11642-00K	
D150H	1999-02	REC64D-11603-01	REC64D-11631-00K REC64D-11642-00K	
L150C	1992	REC61U-11601-00	REC6R5-11631-01K REC6R5-11642-01K	
L150C	1993-95	REC6R5-11603-00	REC6R5-11631-11K REC6R5-11642-11K	
L150F	1996-98	REC64D-11603-01	REC6G5-11631-00K REC6G5-11642-00K	

		ESTRIBOR STD		BABOR PORT
L150FETO	2000	REC64D-11603-01	REC64D-11631-00K REC64D-11642-00K	
L150FETOL/FETOX	2001	REC64D-11603-01	REC64D-11642-00K REC64D-11642-00K	
175A	1984-87	REC6E5-11610-02	REC6G5-11631-00K REC6G5-11642-00K	
175B	1992	REC61U-11601-00	REC6R5-11631-01K REC6R5-11642-01K	
175BETO/CETO	1993-95	REC6R5-11603-00	REC6R5-11631-11K REC6R5-11642-11K	
175D	1996-98	REC64D-11603-01	REC6G5-11631-00K REC6G5-11642-00K	
175DETO	1996-00	REC64D-11603-01	REC64D-11631-00K	
175DETOL	2001-03	REC64D-11603-01	REC64D-11642-00K	
175DETOX	2001-02	REC64D-11603-01	REC64D-11642-00K	
200A	1984-87	REC6E5-11610-02	REC6G5-11631-00K REC6G5-11642-00K	
200B	1992	REC64D-11603-01	REC6R5-11631-01K REC6R5-11642-01K	
200B	1993-95	REC6R5-11603-00	REC6R5-11631-11K REC6R5-11642-11K	
200F	1996-98	REC64D-11603-01	REC6G5-11631-00K REC6G5-11642-00K	
200FETO	2000	REC64D-11603-01	REC64D-11631-00K REC64D-11642-00K	
200FETOL/F	2001-04	REC64D-11603-01	REC64D-11631-00K REC64D-11642-00K	
200G	1999	REC64D-11603-01	REC64D-11631-00K REC64D-11642-00K	
200GETO	2000	REC64D-11603-01	REC64D-11631-00K REC64D-11642-00K	
200GETOL	2001-03	REC64D-11603-01	REC64D-11631-00K REC64D-11642-00K	
L200B	1992	REC6R5-11603-00	REC6R5-11631-01K REC6R5-11642-01K	
L200B	1993-95	REC6R5-11603-00	REC6R5-11631-11K REC6R5-11642-11K	
L200F	1996-01	REC64D-11603-01	REC6G5-11631-00K REC6G5-11642-00K	
L200FETO	1996-00	REC64D-11603-01	REC64D-11631-00K REC64D-11642-00K	
200FETOL	2001-04	REC64D-11603-01	REC64D-11631-00K REC64D-11642-00K	
220A, ET, O	1985-87	REC6E5-11610-02		
225B	1993-95	REC6R5-11603-00	REC6R5-11631-11K REC6R5-11642-11K	
225D	1996-01	REC64D-11603-01	REC6G5-11631-00K REC6G5-11642-00K	
225DETO	1996-00	REC64D-11603-01	REC64D-11631-00K REC64D-11642-00K	
225G	1999	REC64D-11603-01	REC64D-11631-00K REC64D-11642-00K	
225GETO	1999-00	REC64D-11603-01	REC64D-11631-00K REC64D-11642-00K	
225GETOL	2001-03	REC64D-11603-01	REC64D-11631-00K REC64D-11642-00K	
L225C	1994-95	REC6R5-11603-00	REC69L-11631-00K REC69L-11642-00K	
250A	1993-95	REC6R5-11603-00	REC69L-11631-00K REC69L-11642-00K	
250AETO	2000	REC64D-11603-01	REC69L-11631-00K REC69L-11642-00K	
250AETOX	2001-04	REC64D-11603-01	REC69L-11631-00K REC69L-11642-00K	
250B	1997-98	REC64D-11603-01	REC69L-11631-00K REC69L-11642-00K	
250BETO	2000	REC64D-11603-01	REC69L-11631-00K REC69L-11642-00K	
250BETOX	2001	REC64D-11603-01	REC69L-11631-00K REC69L-11642-00K	
L250AETO	2000-05	REC64D-11603-01	REC69L-11631-00K REC69L-11642-00K	
L250AETOX	2001-06	REC64D-11603-01	REC69L-11631-00K REC69L-11642-00K	
L250B	1997-02	REC64D-11603-01	REC69L-11631-00K REC69L-11642-00K	
L250BETO	2000-03	REC64D-11603-01	REC69L-11631-00K REC69L-11642-00K	
L250BETOX	2001-03	REC64D-11603-01	REC69L-11631-00K REC69L-11642-00K	
L250GETO	2006-10	REC64D-11603-01	REC69L-11631-00K REC69L-11642-00K	
L250 A	1997-98	REC64D-11603-01	REC69L-11631-00K REC69L-11642-00K	

GUÍA CORREAS DE DISTRIBUCIÓN

GUIDE TIMING BELT

		REF	OEM
F6A-04/ F6A-05/ F8C-04/ F8C-05/ FT8D-04/ FT8D-05/ F9.9F/ F9.9J/ FT9.9G/ FT9.9L	2000+	60	REC68T-46241-00 68T-46241-00
F8B/ FT9.9A/ F9.9B	1985-06	64	REC6G8-46241-00 6G8-46241-00
F9.9C/ FT9.9D/ F15A	1998-08	68	REC66M-46241-00 66M-46241-00
F15C/ F20B	2007+	80	PAF20-05000003 6AH-46241-00
F20A/ F25A/ FT25B/ F30A/ F40B/ F45A	1998-09	80	REC65W-46241-00 65W-46241-00
F40A/ F50A/ FT50B/ FT50C/ F60A/ FT60B	1995+	106	REC62Y-46241-00 62Y-46241-00
F25D/ FT25F/ F30B/ F40F/ F50F/ FT50G/ FT50J/ F50H/ F60C/ F60F/ FT60D/ FT60G/ F70A	2005+	94	REC6C5-46241-00 6C5-46241-00
F80A/ F80B/ F100A/ F100B/ F100D/ F100F(L)/ F115A	1999+	135	REC67F-46241-00 67F-46241-00
F(L) 115B	2014+	135	PAF115-05000091 6EK-W4624-00
F(L) 150A	2004+	147	REC63P-46241-00 63P-46241-00
F175A/ F(L) 200F / F(L) 200G	2013+		REC6DA-W4624-00 6DA-W4624-00
F(L) 200A/ F(L) 225A	2002-11	159	REC69J-46241-00 69J-46241-00
F(L) 200C/ F(L) 225B/ F225C/ F(L) 250A/ F(L) 250B	2005+	225	REC6P2-46241-02 6P2-46241-02
F(L) 225 / F(L) 250D / F(L) 300	2011+		REC6CB-W4624-00 6CB-W4624-00
F(L) 300 / F(L) 350A	2008+		REC6AW-W4624-00 6AW-W4624-00

YAMAHA

RECMAR®



SISTEMA DE ESCAPE Y ADMISIÓN



EXHAUST & INTAKE SYSTEM



SISTEMA DE ESCAPE



EXHAUST SYSTEM



JUNTAS DEL SISTEMA DE ESCAPE



REF	OEM		
PAF15-04010004	66M-41138-00	F9.9/15/13.5 T9.9	



REF	OEM		
PAF15-03000003	66M-45115-00	F9.9/13.5/15 T9.9	



REF	OEM		
REC682-41133-A0	682-41133-A0	9.9D E9.9DMH 15D E15DMH	

REF	OEM		
REC63V-41133-A1	63V-41133-A1	9.9F/FEM/FMH/MH/AW/MSH 13.5AWH	



REF	OEM		
PAF25-05080004	65W-14457-10	F20/25 T25	

REF	OEM		
PAF40-02000008	62Y-45127-00	F20/25/40/45/50 T50	

REF	OEM		
REC67C-41133-00	67C-41133-00	F20/25/40/50/30 T25	

REF	OEM		
PAF40-02000007	67C-45123-00	F20/25/40/50/30 T25	



EXHAUST GASKETS

REF	OEM		
REC663-45123-00	663-45123-00	25QE0 40H/N F40/45/50 50ETN T50 55B E55CM	



REF	OEM		
REC6H3-45123-00	6H3-45123-00	25B/BETO, 50G/GEO/GETO 60FE/FET/FE0/FETO/FEDO E60H/MHZ/MLH/HMH/HW 70B/ETN/BEH/BE0/BEMO/BETO/CE	



REF	OEM		
REC66T-41133-A1	66T-41133-A0	40X/XW/XMH E40X/MLN	

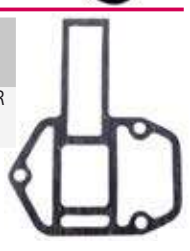

REF	OEM		
REC676-41133-A0	676-41133-A0	40QE/QE-Z/QM/QWC	

REF	OEM		
REC676-45127-00	676-45127-00	40QE/QE-Z/QM/QWC	



REF	OEM		
REC688-41134-00	688-41134-A0	75A/AE/AED/CETO/TLR 80A/AEO, 85A/AED-T 90A/AET/AEO	



REF	OEM		
REC688-45123-00	688-45123-00		
			75CETO/TLR E75B/AED 80A/AE/TLR 85A/AE 90A/AE/TLR/TR

REF	OEM		
REC6G5-41134-A1	6G5-41134-A1		
			130BETO 150FETO/PETO/TR 175DETO/GETO/TR Z200 200AET/ FETO/NETO/TXR 225DET



REF	OEM		
REC6E5-41135-A0	6E5-41135-A0		
			100A/AET/TLR 115B/BETO/CEO/CETO/TXR 130BETO

REF	OEM		
REC69J-41138-00	69J-41138-00		
			F200/225/250

REF	OEM		
REC6E5-41134-A0	6E5-41134-A0		
			100A/AET/TLR 115B/BETO/CEO/CETO/TXR, 130BETO

REF	OEM		
REC6A1-14613-A0	6A1-14613-A0, 00, 01		
			2B/C/M (1985-10) 2T/strokes



REF	OEM	
REC688-41133-00	688-41133-00	



REF	OEM		
PAF40-02010007	6BG-41134-00		
			F25 --> F50

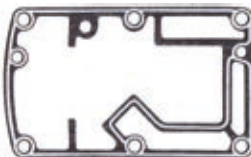

JUNTAS DE COLECTOR Y CARTER

GASKET, UPPERCASING, OIL PAN, MANIFOLD

REF	OEM		
REC646-14623-A1	646-14623-A1		
			2B

REF	OEM		
PAF4-04000002	68D-11351-A0		
			F4



REF	OEM		
PAF2.6-04000004	69M-11351-A0		
			F2.5

REF	OEM		
REC682-45113-A0	682-45113-02		
			9.9D 15D

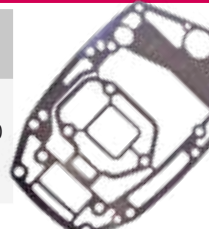
REF	OEM	
REC27-49955		

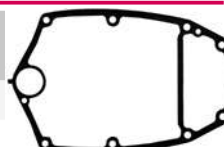

REF	OEM		
REC6H3-45114-A1	6H3-45114-A1		
			25B/BETO 50G/GEO/GETO 60FEDO/TLR/BEO E60H/MLHHMH 70B/BEO 70BETO/TR



REF	OEM		
REC66T-45114-A0	66T-45114-A0	40X/XMH/XW E40X/MLH/XMH	

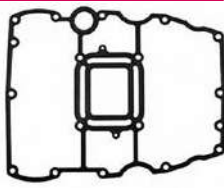

REF	OEM		
PAF25-02010007	67C-15312-00	F25/30/40 T25	

REF	OEM		
REC676-45114-A1	676-45114-A1	40QE/QE-Z/QM/QWC/GWH/JWH E40GMH/JMH	

REF	OEM		
REC68V-15312-00	68V-15312-00	F80/100/115	

REF	OEM		
REC697-45114-00	697-45114-A0	E48CMH 55BET/B/BE/BM E55CMH	

REF	OEM		
REC6G5-45114-A0	6G5-45114-A1	115A/B/ETN/BETO, 130BETO, 140AETO/BETO 150ETN/AETO/CETO/FETO, Z150, Z175, 175AETO, 200ETN/AET-0, Z200 225AETO/DET	

REF	OEM		
REC688-45114-A1	688-45114-A1	75A/AE/CETO/TLR/AED E75B 85A/AED-M-T 80A/AE/AEO 90A/ETN/AEO/AETO	

REF	OEM		
REC6E5-45114-00	6E5-45114-A0	115A/ETN E115AEL 140AETO	

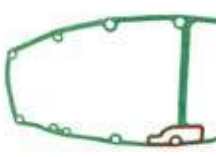

REF	OEM		
PAF15-00000005	66M-45113-00	F15/9.9/13.5 FT9.9	

SISTEMA DE ADMISIÓN



INTAKE SYSTEM



JUNTAS DEL SISTEMA DE ADMISIÓN



GASKETS INTAKE



REF	OEM		
REC682-13621-00	682-13621-A0	9.9D 15D	



REF	OEM		
REC648-13645-A0	648-13645-A0	20CM/C, 25DE/BMH/B/D/V 30A/HM/HW/G/GE, E30HMH	

REF	OEM		
REC677-24434-02	677-24434-02	E8D/DMH, 9.9D/15D 25D/NH/NMH/MH/NE/NEMO 20DMH/MLH/DW	



REF	OEM		
REC677-14198-A1	677-14198-A1	20CM/C 25DE/BMH/B/D/V 30A/HM/HW/G/GE E30HMH	



REF	OEM		
REC648-13621-A0	648-13621-A1	20CM/C 25DE/BMH/B/D/V 30A/HM/HW/G/GE E30HMH	



REF	OEM		
REC677-13621-00	677-13621-A1	20CM/C 25DE/BMH/B/D/V 30A/HM/HW/G/GE E30HMH	

REF	OEM		
REC648-14198-A0	648-14198-A0	20C/CM 25D/DE 30A	



REF	OEM		
REC6F5-13621-A1	6F5-13621-A1	40GWH/JWH E40GMH/JMH	



REF	OEM		
REC6H4-14198-01	6H4-14198-01	25Q/QEO/B 50D/G/GEO/GET/H 40V/VM/TLR/H C40T/40YET 60FEO/FET/D 70B/BE	



REF	OEM		
REC6F5-13646-A2	6F5-13646-A1	40GWH/JWH E40GMH/JMH	

REF	OEM		
REC61N-14198-00	61N-14198-00	25VE/VM/B/BMH/BWH E25A/BMH 30G/GE/HMH/HW E30HMH	



REF	OEM		
REC6F5-13645-A0	6F5-13645-A1	40GWH/JWH E40GMH/JMH	

REF	OEM		
REC682-13621-00	682-13621-A0	25B, 50G/GEO/GETO, 60FEO/FETO/TLR/TRZ/F, E60H/E60M 70BEO/B/BE/BEDO/BETO/TR	

REF	OEM		
REC6F5-14198-A1	6F5-14198-A1	40GWH/JWH E40GMH/JMH	



REF	OEM		
REC6H3-14198-A1	6H3-14198-A1	25B, 50G/GEO/GETO 60FEO/FETO/TLR/TRZ/F, E60H/E60M 70BEO/B/BE/BEDO/BETO/TR	



REF	OEM		
REC663-14483-A0	663-14483-A0	E40CMH 55B/BE/BET E55CMH	

REF	OEM		
REC6H3-13622-A1	6H3-13622-A1	25B 50G/GEO/GETO 60FEO/FETO/TLR/TRZ/F, E60H/E60M 70BEO/B/BE/BEDO/BETO/TR	



REF	OEM		
REC663-14198-00	663-14198-A0	E48CMHS 55BET/B/BE/BM	



REF	OEM		
REC688-14483-A0	688-14483-A0	E40CMH 55B/BE/BET, E55CMH	

REF	OEM		
REC663-13621-00	663-13621-A0	E48CMHS 55BET/B/BE/BM	



REF	OEM		
REC688-14416-01	688-14416-01	75AET/AEM/AED, E75B 85A/AE/AET/AED	

REF	OEM	
REC663-13622-00	663-13622-00	



REF	OEM		
REC6E5-14416-A1	6E5-14416-A1		115B/BE/BET C115TLR
			

REF	OEM	
REC688-13621-A1	688-13621-A1	
		75AET/AEM/AED, E75B 85A/AE/AET/AED
		

REF	OEM	
REC6H3-13621-A1	6H3-13621-A1	
		25B 50G/GE0/GETO, 60FE0/FETO/TLR/TRZ/F E60H/E60M 70BEO/B/BE
		



REF	OEM	
REC6E5-13621-A1	6E5-13621-A1	
		100A/TLR, 115BE/B/CETO/TXR 130BETO/TLR 150F/FETO/TXR/TR/GETO/A/AETO 175DETO/D/FETO 225DET/D
		

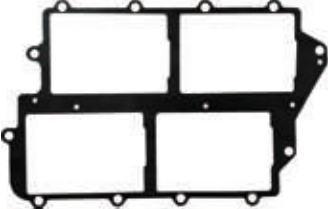

REF	OEM	
REC6K7-14483-00	6KE-14483-00	



REF	OEM		
REC6E5-14483-A1	6E5-14483-A1		115B/BE/BET C115TLR
			



REF	OEM	
REC6E5-13645-A1-00	6E5-13645-A1	
		100A/TLR 115BE/B/CETO/TXR 130BETO/TLR 150F/FETO/TXR/TR/GETO/A/AETO 175DETO/D/FETO 225DET/D
		

REF	OEM	
REC6G5-14416-A1	6G5-14416-A1	
		150A-AET
		

REF	OEM		
REC688-14198-A1	688-14198-A2		Z150P/Q/TLR 175G/GET 200NETO/N/TR/PET 250G/GET/B
			

REF	OEM	
REC6E5-14198-A2	6E5-14198-A2	
		100A/TLR 115BE/B/CETO/TXR 130BETO/TLR 150F/FETO/TXR/TR/GETO/A/AETO 175DETO/D/FETO 225DET/D
		

REF	OEM	
REC6G5-14483-01	6G5-14483-A1	
		150A/AETO, 175AE/AETO, 200AET/AETO
		

REF	OEM	
REC6E5-11381-A1	6E5-11381-A1	
		115BET/CEO 130BET 150CET 175BET 200CETO 225BET
		

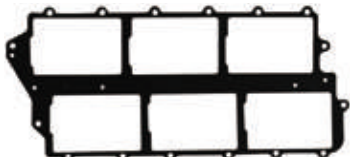
REF	OEM	
REC6G5-13645-A1	6G5-13645-A2	
		150A/AETO, 175AE/AETO, 200AET/AETO
		

UNIDADES DE TRANSMISIÓN UNIT DRIVES & COMPONENTS

COLA COMPLETA

COMPLETE GEARCASE ASSY

4T
STROKES

COLAS DE 4 TIEMPOS

4 STROKES GEARCASE

REF	OEM	REDUCCIÓN GEAR RATIO		
PAF2.6-03020000S	69M-65300-01-4D	17"	2.08	F2.5 (2003+)
PAF2.6-03020000L	69M-65300-11-4D	22"	2.08	



REF	OEM	REDUCCIÓN GEAR RATIO		
PAF4-0310000S	68D-65300-03-4D	17.1"	2.08	F4 (1998-2009)
PAF4-0310000L	68D-65300-11-4D	22.1"	2.08	

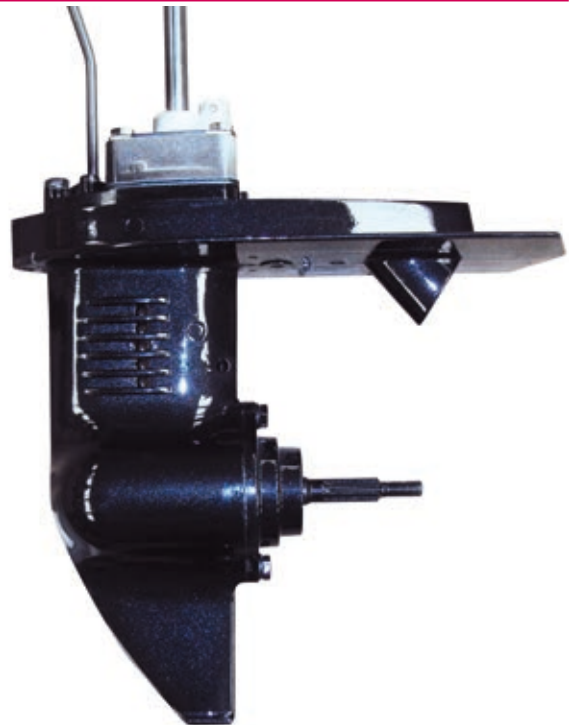

YAMAHA

RECMAR®

REF	OEM	REDUCCIÓN GEAR RATIO	
PAF15-06100000S	66M-45300-02-4D	17.3"	2.08 F9.9 (1998-2008) F13.5 (2002-2007)
PAF15-06100000L	66M-45300-11-4D	22.3"	2.08 F15 (1998-2007)



REF	OEM	REDUCCIÓN GEAR RATIO	
PAF20-04000000S	6AH-45300-00-4D 6AH-45300-00-8D	17.1"	2.08 F9.9 (2009-18) F13.5 (2007-09)
PAF20-04000000L	6AH-45300-10-4D 6AH-45300-10-8D	22.1"	2.08 F15 (2007-18) F20 (2007-18)

REF	OEM	REDUCCIÓN GEAR RATIO	
PAF25-04090000S	65W-45300-01-4D	16.6"	2.08 F20 (1998-2003)
PAF25-04090000L	65W-45300-01-4D	21.6"	2.08 F25 (1998+)



REF	OEM	REDUCCIÓN GEAR RATIO		
PAF60-04000000	69W-45300-00-4D	20"	1.85	F40D/H (2006+)
	69W-45300-00-8D			F50F/H/T (2005+)
	69W-45300-01-8D			F60A/B/C/T (2002+)



2T
STROKES

COLAS DE 2 TIEMPOS

2 STROKES GEARCASE

REF	OEM	REDUCCIÓN GEAR RATIO		
REC63V-45300-13-8D	63V-45300-13-8D	L 22.3"	2.08	9.9 /15 HP (63V & 63W) (1995+)
	63V-45300-13-4D			
	63V-45300-10-4D			
	63V-45300-03-8D			
REC63V-45300-03-8D	63V-45300-03-4D	S 17.3"	2.08	13.5 HP (66S)
	63V-45300-00-4D			



REF	OEM	REDUCCIÓN GEAR RATIO		
PAF40-04000000L	66T-45300-10-4D	20"	2.08	(E)40X/M (1998-09)
	66T-45311-13-8D			

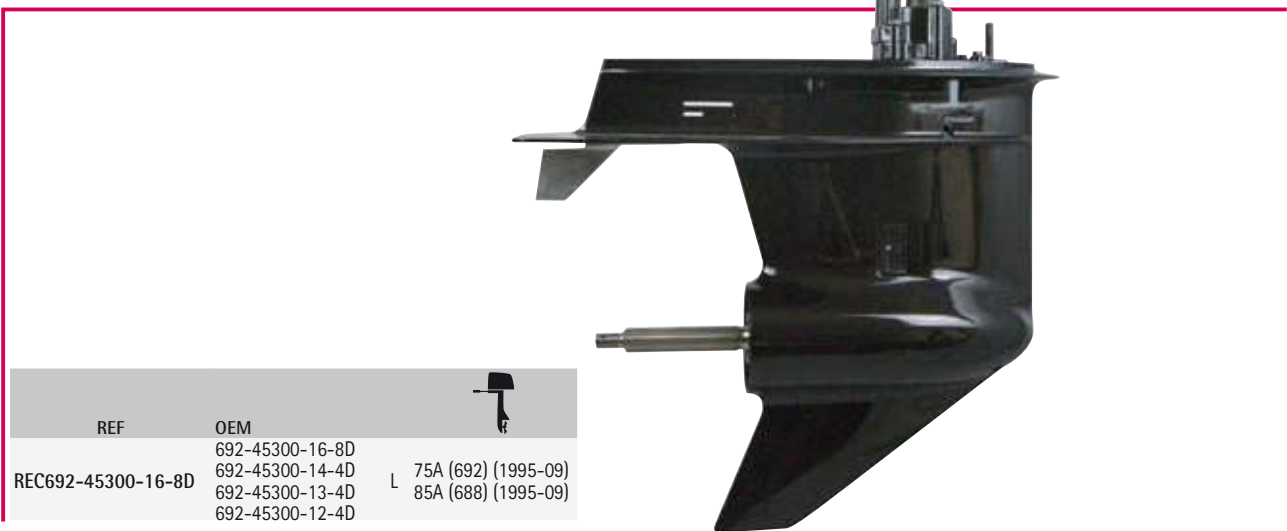
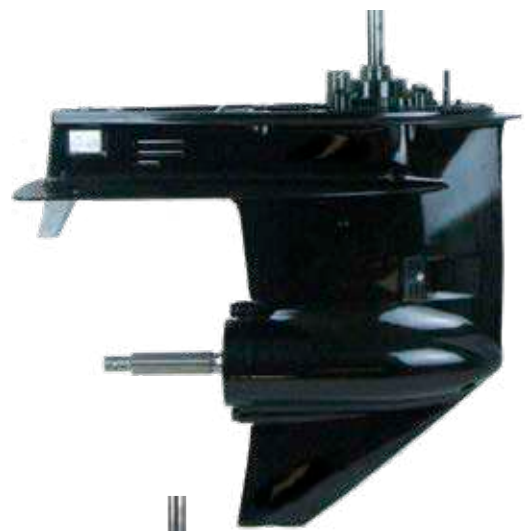

REF	OEM	REDUCCIÓN GEAR RATIO		
REC692-45300-16-8D	692-45300-16-8D	L	75A (692) (1995-09) 85A (688) (1995-09)	
	692-45300-14-4D			
	692-45300-13-4D			
	692-45300-12-4D			

YAMAHA

RECMAR®

DESPIECE COLAS 4 TIEMPOS

GEAR CASE PARTS 4 STROKES

4T F2.5 (2003+)
STROKES

YAMAHA

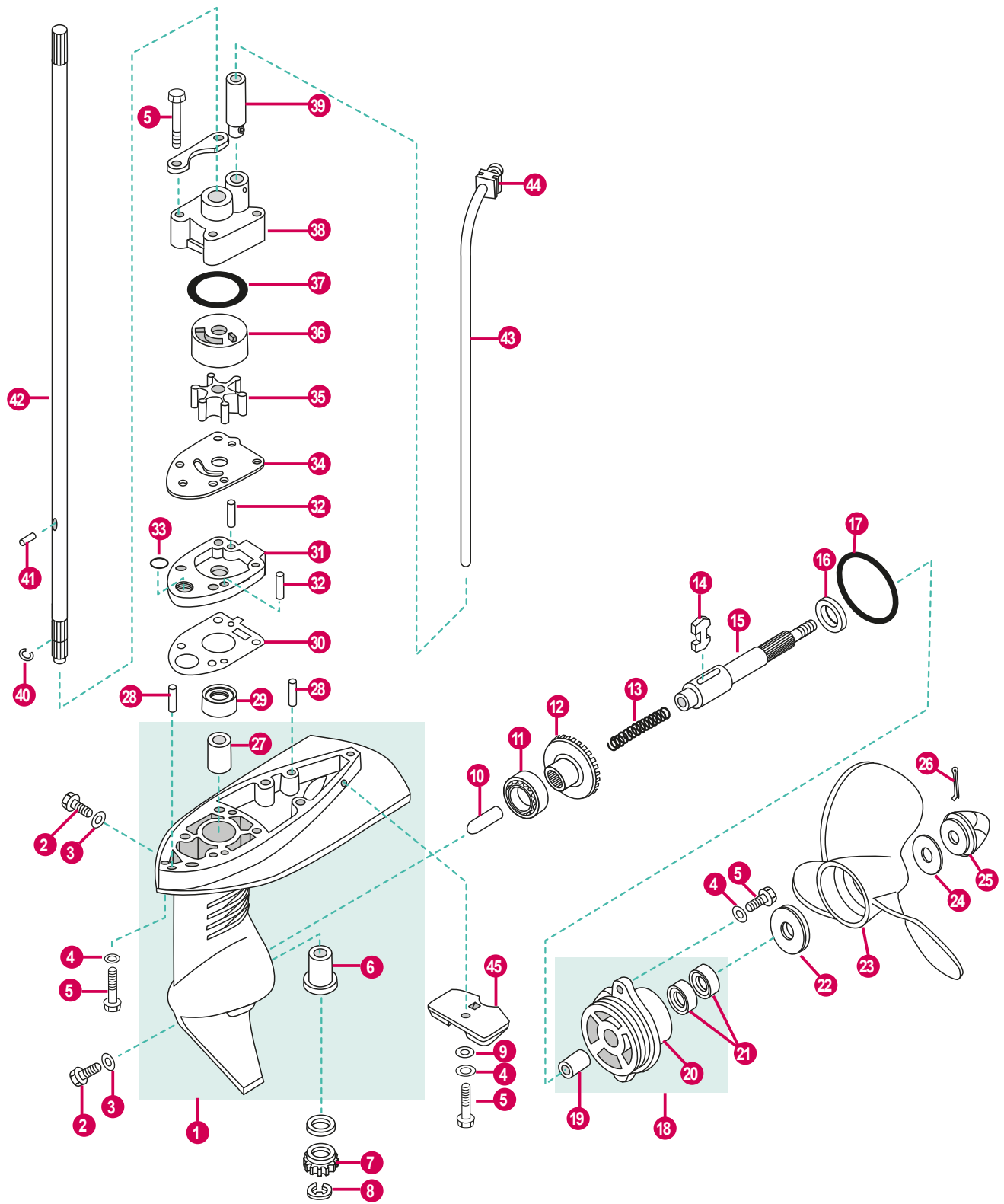

	REF	OEM		
	PAF2.6-03020000L	69M-G5300-01-4D	COLA COMPLETA L	COMPLETE GEAR HOUSING L
	PAF2.6-03020000S	69M-G5300-00-4D	COLA COMPLETA S	COMPLETE GEAR HOUSING S
1	PAF2.6-03000001	69M-G5311-00-4D	CARCASA	LOWER CASING
2	REC90340-08002	90340-08002	TAPÓN ACEITE	PLUG, OIL
3	REC90430-08020	90430-08020	JUNTA	GASKET
4	PAGB/T97.1-8	97595-06520	ARANDELA	WASHER
5	PAGB/T5783-M5X12	95895-06020	TORNILLO	BOLT
6	PAF2.6-03000002	6L5-45317-09	COJINETE	BEARING
7	PAF2.6-03000018	6L5-45551-00	PIÑÓN ATAQUE	INITIATIVE GEAR
8	PAGB/T896-86	99001-06600	CIRCLIP	CIRCLIP
9	PAGB/T861.1-87	92990-06300	ARANDELA	WASHER
10	PAF2.6-03000020	69M-G5635-00	TAPÓN CAMBIO	PLUG, SHIFT
11	PANTN16003EY	93316-003Y0	COJINETE	BEARING
12	PAF2.6-03000019	6L5-45560-00	PIÑÓN MARCHA AVANTE	POSITIVE GEAR ASSY
13	PAF4-03030003	90501-10064	MUELLE	SPRING, CLUTCH BLOCK
14	PAF2.6-03000202	6L5-45631-00	SELECTOR	CLUTCH BLOCK
15	PAF2.6-030000201	6L5-45631-00	EJE HÉLICE	SHAFT, PROPELLER
16	PAF2.6-03000021	90201-13198	ARANDELA	WASHER
17	PAJISB2401P48	93210-48214	TÓRICA	O-RING
18	PAF2.6-03000300	69M-G5361-00-4D	TAPA CARTER COMPLETA	COVER ASSY, LOWER CASING
19	PAF2.6-03000302		COJINETE CAMISA	BEARING, SLEEVE
20	PAF2.6-03000301	69M-G5361-00-4D	TAPA CARTER	COVER, LOWER CASING
21	PAF4-03050002	93101-13M12	RETÉN DE ACEITE	OIL SEAL
22	PAF4-03000025	68D-G5978-00	ESPACIADOR	SPACER
23	PAF2.6-03010000	6L5-45943-00-EL	HÉLICE	PROPELLER ASSY
24	PAF4-03000026	90201-08M54	ARANDELA	WASHER
25	PAF4-03080000	6L5-45616-00	TUERCA	LOCK NUT
26	PAGB/T91-1.6X12	91490-25030	PASADOR ALETAS	PIN, COTTER
27	PAF2.6-03000003	6L5-45316-09	COJINETE	BEARING
28	PAF15-00000013	93604-12M07	PASADOR	PIN
29	PAF2.6-03000004	93103-09M41	RETÉN DE ACEITE	OIL SEAL
30	PAF2.6-03000007	69M-G5315-A0	JUNTA	GASKET, WATER PUMP
31	PAF2.6-03000008	69M-G5321-00-94	CUERPO BOMBA	HOUSING, WATER PUMP
32	PAF4-03000013	93604-18080	PASADOR	PIN
33	PAF2.6-03000009	93210-05001	TÓRICA	O-RING
34	PAF2.6-03000010	69M-G4323-00	PLACA	OUT PLATE
35	PAF2.6-03000100	6L5-44352-00	TURBINA	IMPELLER
36	PAF2.6-03000015	6L5-44322-00	TAPA BOMBA AGUA	COVER, INNER WATER PUMP
37	PAJASOF404-19-033	93210-33M85	TÓRICA	O-RING
38	PAF2.6-03000014	69M-G4311-00	CUERPO BOMBA	WATER PUMP HOUSING
39	PAF4-03000021	6R0-44366-00	TUBO BOMBA AGUA	RUBBER TUBE, WATER PUMP
40	PAF2.6-03000012	93440-08819	CIRCLIP	CIRCLIP
41	PAF2.6-03000013	93604-07M13	PASADOR	PIN
42	PAF2.6-03000011S	69M-G5511-00	EJE VERTICAL S	DRIVE SHAFT S
	PAF2.6-03000011L	69M-G5511-10	EJE VERTICAL L	DRIVE SHAFT L
43	PAF2.6-02000003S	69M-44361-00	TUBO DE AGUA S	WATER TUBE S
	PAF2.6-02000003L	69M-44361-10	TUBO DE AGUA L	WATER TUBE L
44	PAF4-02040002	68D-G4365-00	GOMA DEL TUBO DE AGUA	I-SHAPED RUBBER BAND
45	REC6L5-45251-03AL	6L5-45251-03	ÁNODO	ÁNODO

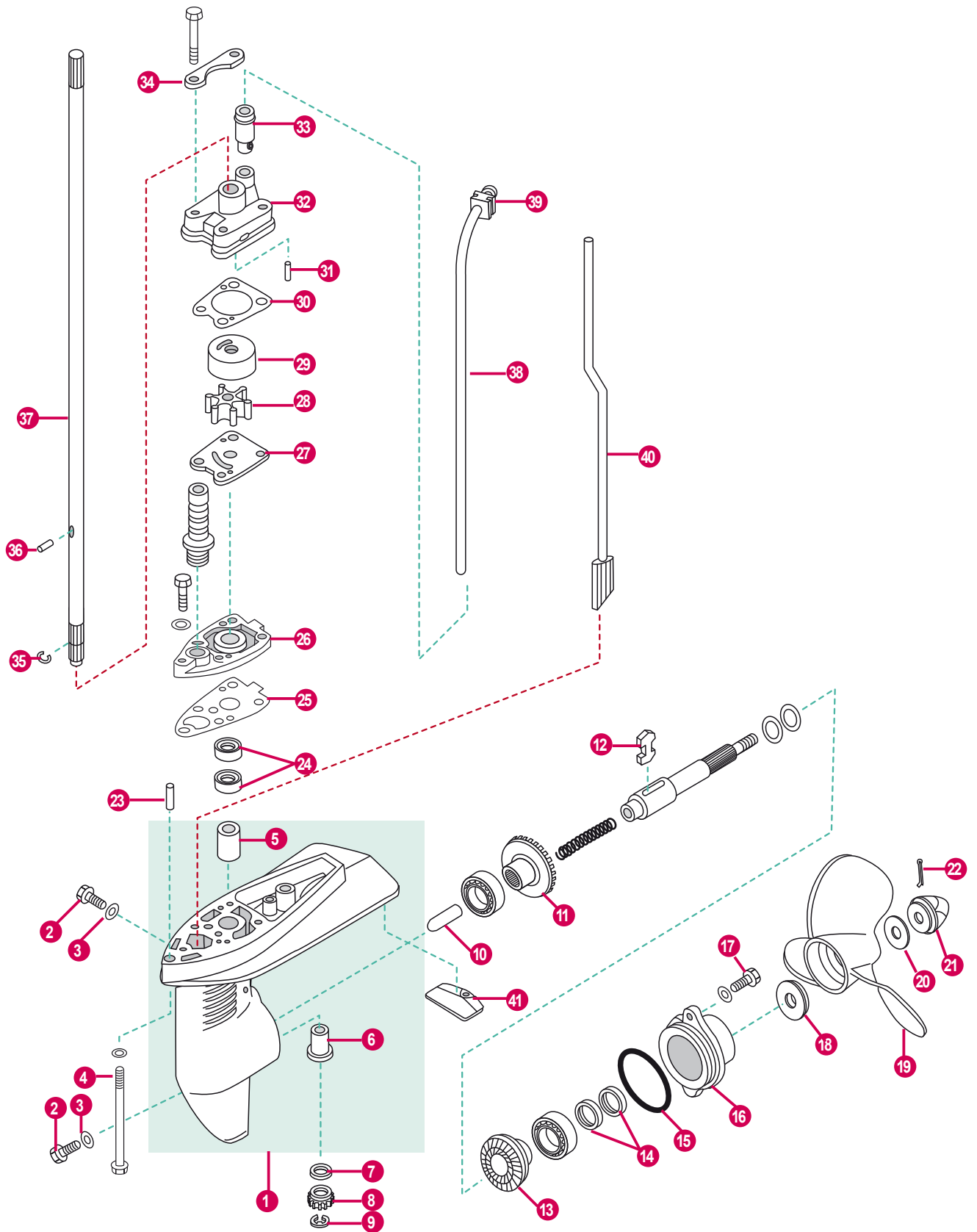

	REF	OEM		
	PAF4-0310000L	68D-G5300-10-4D	COLA COMPLETA L	COMPLETE GEAR HOUSING L
	PAF4-0310000S	68D-G5300-00-4D	COLA COMPLETA S	COMPLETE GEAR HOUSING S
1	PAF4-03000001	68D-G5300-11-4D	CARCASA MOTOR	CRANK CASE
2	REC90340-08002	90340-08002	TAPÓN ACEITE	PLUG, OIL
3	REC90430-08020	90430-08020	JUNTA	GASKET
4	PAGB/T5782-M6X125	97013-06035	TORNILLO HEXAGONAL L	HEXAGON BOLT L
	PAGB/T5782-2000S	PAGB/T5782-2000S	TORNILLO HEXAGONAL S	HEXAGON BOLT S
5	PAF4-03000003	6E0-45316-09	RODAMIENTO	BALL BEARING
6	PAF4-03000002	6E0-45317-09	COJINETE	BEARING
7	PAF4-03000006	90204-11M49	ARANDELA	WASHER
8	PAF4-03000007	6E0-45551-00	PIÑÓN ATAQUE	INITIATIVE GEAR
9	PAGB/T896-86	99001-06600	CIRCLIP	CIRCLIP
10	PAF4-03000008	67D-45635-00	ÉMBOLO	PLUGER, SHIFT
11	PAF4-03010000	67D-45560-00	PIÑÓN MARCHA AVANTE	POSITIVE GEAR ASSY
12	PAF4-03030002	67D-45631-01	SELECTOR	CLUTCH BLOCK
13	PAF4-03040000	67D-45570-00	PIÑÓN MARCHA ATRÁS	REVERSE GEAR
14	PAF4-03050002	93101-13M12	RETÉN DE ACEITE	OIL SEAL
15	PAJISB2401P48	93210-48214	TÓRICA	O-RING
16	PAF4-03050001	68D-G5361-00-4D	TAPA CÂRTER	COVER, LOWER CASING
17	PAGB/T5783-M5X12	95895-06016-00	TORNILLO HEXAGONAL	HEXAGON BOLT
18	PAF4-03000025	68D-G5987-00	ESPACIADOR	SPACER
19	PAF4-03070000	6E0-45943-01-EL	HÉLICE	PROPELLER
20	PAF4-03000026	90201-08M54	ARANDELA INOX.	WASHER, STAINLESS STEEL
21	PAF4-03080000	6L5-45616-00	TUERCA	LOCK NUT
22	PAGB/T91-1.6X12	91490-25030	PASADOR ALETAS	PIN, COTTER 2.5x30
23	PAF4-00000001	90387-06806	PASADOR VACÍO	HOLLOW PIN
24	PAF4-04060004	93101-10M14	RETÉN DE ACEITE	OIL SEAL
25	PAF4-03000011	68D-G5315-A0	JUNTA HERMÉTICA BASE	HERMETIC GASKET, WATER PUMP BASE
26	PAF4-03000012	68D-G5321-00	BASE BOMBA AGUA	BASE, WATER PUMP
27	PAF4-03000015	6E0-44323-00	PLACA	OUT PLATE
28	PAF4-03060000	6E0-44352-00	TURBINA BOMBA AGUA	IMPELLER, WATER PUMP
29	PAF4-03000017	6E0-44322-02	TAPA, BOMBA AGUA	COVER, INNER WATER PUMP
30	PAF4-03000018	68D-G4315-A0	JUNTA TAPA BOMBA AGUA	GASKET, WATER PUMP COVER
31	PAF4-03000013	93604-18080	PASADOR BOMBA AGUA	PIN, WATER PUMP
32	PAF4-03000019	68D-G4311-01	CUERPO BOMBA AGUA	HOUSING, WATER PUMP
33	PAF4-03000021	67D-44366-00	TUBO GOMA BOMBA AGUA	RUBBER TUBE, WATER PUMP
34	PAF4-03000020	68D-G4328-00	PLCA BOMBA AGUA	PLATE, WATER PUMP FIXED
35	PAF4-03000005	90467-08M01	CLIP	CLIP
36	PAF4-03000016	93604-09066	PASADOR	PIN
37	PAF4-03000004L	6E0-45511-11	EJE VERTICAL S	DRIVE SHAFT S
	PAF4-03000004S	6E0-45511-01	EJE VERTICAL L	DRIVE SHAFT L
38	PAF4-02040001	68D-G4360-10	TUBO DE AGUA S	WATER TUBE S
	PAF4-02040001S	68D-G4360-00	TUBO DE AGUA L	WATER TUBE L
39	PAF4-02040002	68D-G4365-00	GOMA DEL TUBO DE AGUA	I-SHAPED RUBBER BAND
40	PAF4-03020000L	68D-G4150-10	VARILLA SELECTOR L	CAM ASSY, SHIFT ROD L
	PAF4-03020000S	68D-G4150-00	VARILLA SELECTOR S	CAM ASSY, SHIFT ROD S
45	REC6L5-45251-03AL	6L5-45251-03	ÁNODO	ÁNODE



REF	OEM
REC6E0-W0078-A2	6E0-W0078-A2



REF	OEM
REC6E0-W0001-C1	6E0-W0001-C1

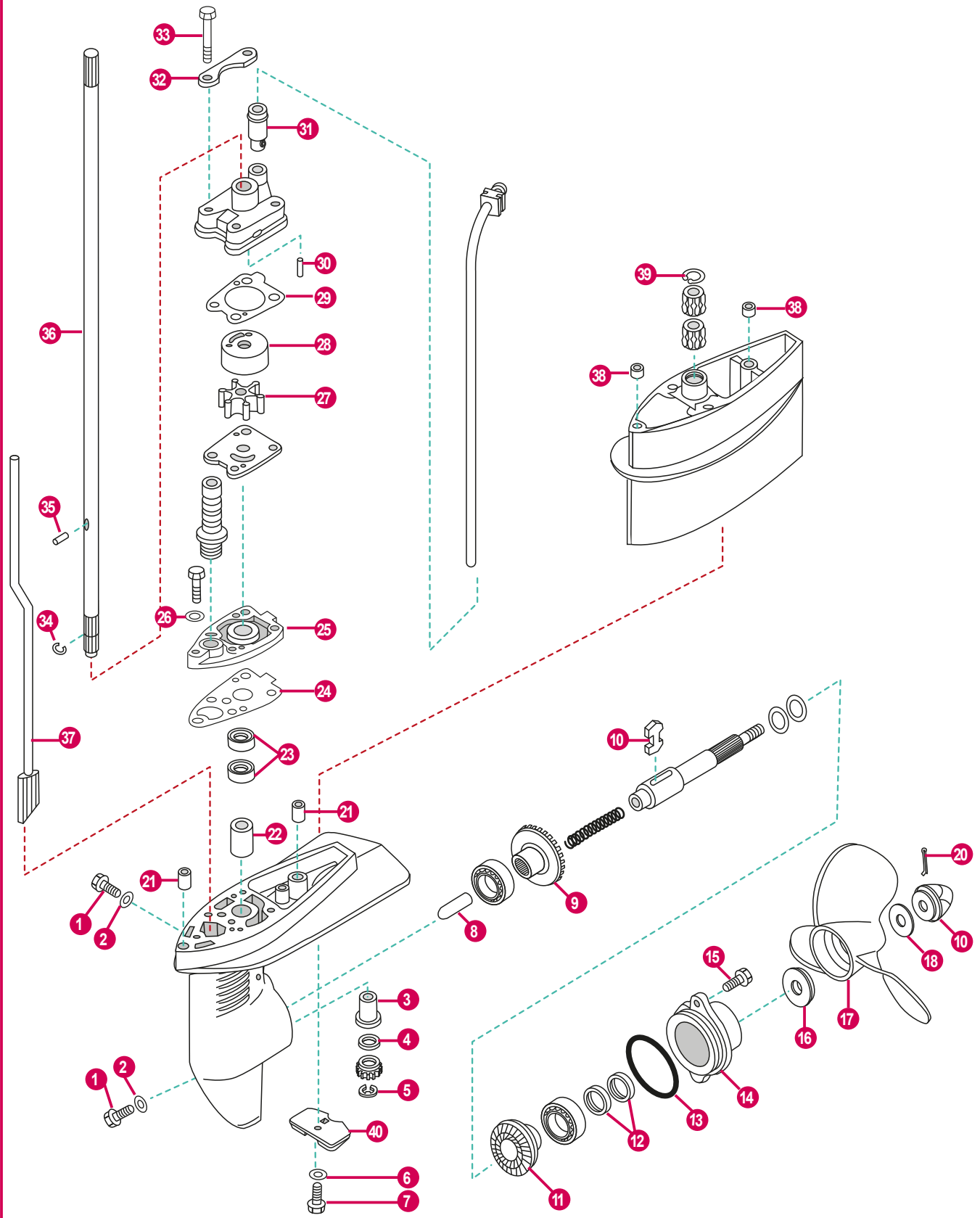

	REF	OEM		
1	REC90340-08002	90340-08002	TORNILLO DRENAJE	BOLT, DISCHARGING OIL
2	REC90430-08020	90430-08020	JUNTA	GASKET
3	PAF4-03000002	6E0-45317-09	COJINETE	BEARING
4	PAF4-03000006	90201-11M49	ARANDELA	WASHER
5	REC99001-06600	99001-06600	CIRCLIP	CIRCLIP
6	PAGB/T861.1-87	92990-06300	ARANDELA	WASHER
7	PAGB/T5783-M6X14	95895-06012	TORNILLO	SCREW
8	PAF4-03000008	67D-45635-00	ÉMBOLO	PLUGER, SHIFT
9	PAF4-03010000	67D-45560-00	PIÑÓN MARCHA AVANTE	POSITIVE GEAR ASSY
10	PAF4-03030002	67D-45631-01	SELECTOR	CLUTCH BLOCK
11	PAF4-03040000	67D-45570-00	PIÑÓN MARCHA ATRÁS	REVERSE GEAR
12	REC93101-13M12	93101-13M12	RETÉN DE ACEITE	OIL SEAL
13	REC93210-48214	93210-48214	TÓRICA	O-RING
14	PAF4-03050001	68D-G5361-00-4D	TAPA CÁRTER	COVER, LOWER CASING
15	PAGB/T5783-M5X12	95895-06016	TORNILLO HEXAGONAL	HEXAGON BOLT M6x18
16	PAF4-03000025	68D-G5987-00	ESPACIADOR	SPACER
17	PAF4-03070000	6E0-45943-01	HÉLICE	PROPELLER
	PAF2.6-03010000	6E0-45949-00	HÉLICE	PROPELLER
18	PAF4-03000026	90201-08M54	ARANDELA INOX.	WASHER, STAINLESS STEEL
19	PAF4-03080000	6L5-45646-00	TUERCA	LOCK NUT
20	PAGB/T91-1.6X12	91490-25030	PASADOR ALETAS	PIN, COTTER 2.5x30
21	PAF4-00000001	90387-06806	ESPACIADOR	SPACER
22	PAF4-03000003	6E0-45316-09	RODAMIENTO	BALL BEARING
23	PAF4-04060004	93101-10M14	RETÉN DE ACEITE	OIL SEAL
24	PAF4-03000011	68D-G5315-A0	JUNTA BASE	GASKET, WATER PUMP BASE
25	PAF4-03000012	68D-G5321-00	PLACA	OUT PLATE
26	PAGB/T96-6	92995-06600	ARANDELA	WASHER
27	REC6E0-44352-00	6E0-44352-00	TURBINA BOMBA AGUA	IMPELLER, WATER PUMP
28	PAF6-03000002	6BX-44322-00	TAPA, BOMBA AGUA	COVER, INNER WATER PUMP
29	PAF4-03000018	6BX-G4315-01	JUNTA TAPA BOMBA AGUA	GASKET, WATER PUMP COVER
30	PAF4-03000013	93604-18080	PASADOR BOMBA AGUA	PIN, WATER PUMP
31	PAF4-03000021	67D-44366-00	TUBO GOMA BOMBA AGUA	RUBBER TUBE, WATER PUMP
32	PAF4-03000020	68D-G4328-00	PLCA BOMBA AGUA	PLATE, WATER PUMP FIXED
33	REC97095-06045	97095-06045	TORNILLO	SCREW
34	PAF4-03000005	90467-08M01	CLIP	CLIP
35	PAF4-03000016	93604-09066	PASADOR	PIN
36	PAF4-03000004S	68D-G5511-00	EJE VERTICAL S	DRIVE SHAFT S
	PAF4-03000004L	68D-G5511-10	EJE VERTICAL L	DRIVE SHAFT L
37	PAF4-03020000S	6BX-G4150-00	EJE LEVA COMPLETO S	CAM ASSY, SHIFT ROD S
	PAF4-03020000L	6BX-G4150-10	EJE LEVA COMPLETO L	CAM ASSY, SHIFT ROD L
38	PAF4-00000001	90387-06806	ESPACIADOR	SPACER
39	PAGB/T893.1-22	93420-22M03	SEGURO	CLAMP
45	REC6L5-45251-03AL	6L5-45251-03	ÁNODO	ÁNODE

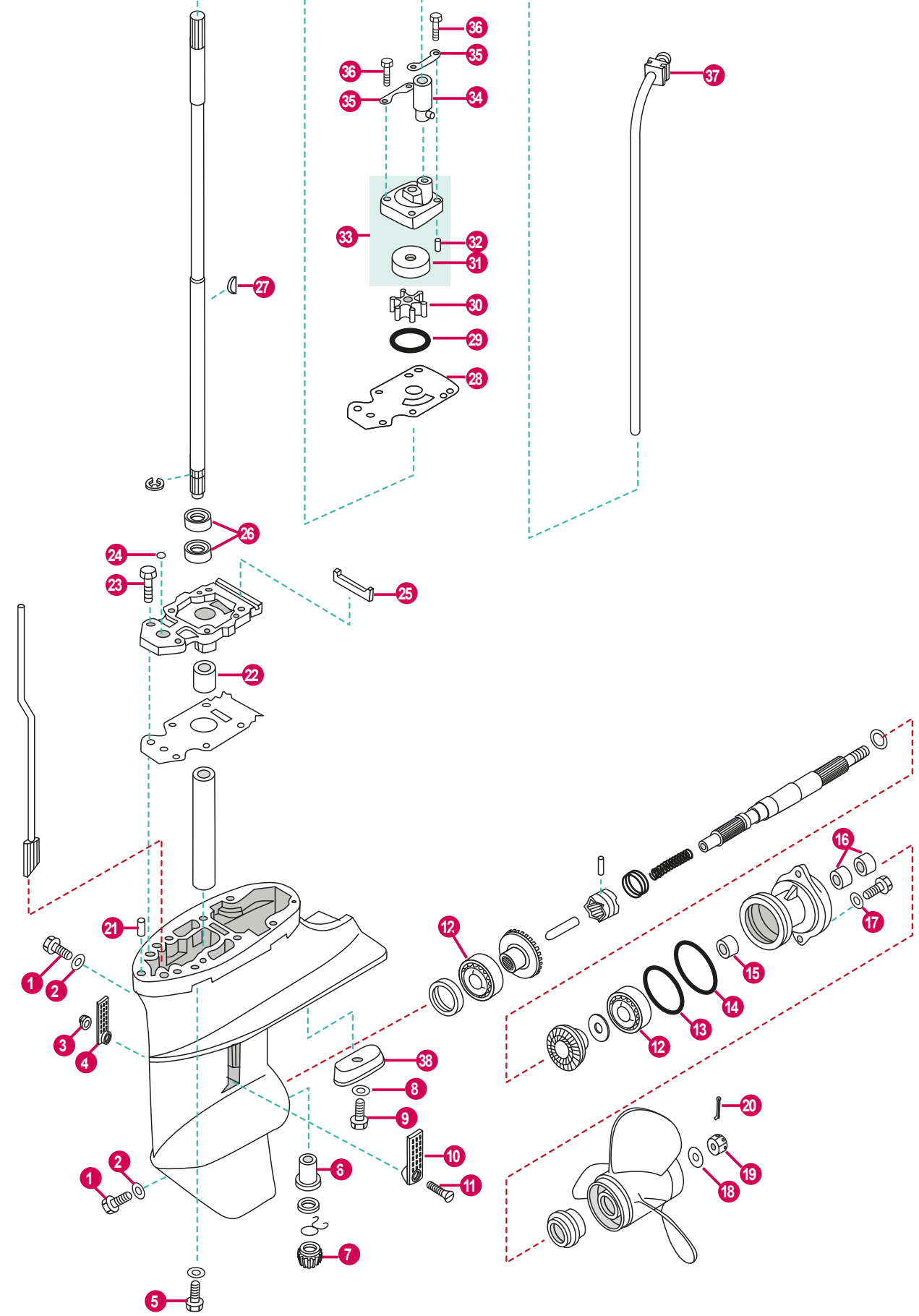

	REF	OEM		
1	REC90340-08002	90340-08002	TORNILLO DRENAJE	BOLT, DISCHARGING OIL
2	REC90430-08020	90430-08020	JUNTA	GASKET
3	PAGB/T6182-M5	90185-05002	TUERCA AUTOBLOCANTE	NUT LOCKING M5
4	PAF15-06000002	6G1-45215-00	CUBIERTA ENTRADA DE AGUA 2	WATER INLET 2
5	PAGB/T5783-M8X35	97075-08035	PERNO	STUD
6	REC6G1-45317-09	6G1-45317-09	RODAMIENTO	BALL BEARING
7	REC68T-45551-00	6N0-G5551-A0	PIÑÓN ATAQUE	INITIATIVE GEAR
8	PAGB/T861.1-87	92990-06300	ARANDELA	WASHER
9	PAGB/T5783-M5X12	95895-06016	TORNILLO	SCREW
10	PAF15-06000003	6G1-45214-00	CUBIERTA ENTRADA DE AGUA 1	WATER INLET 1
11	PAGB/T820-M5X25	90152-05M03	TORNILLO	SCREW
12	PAGB/T276-6004C2	93306-004YH	COJINETE	BEARING
13	REC93210-49046	93210-49046	TÓRICA	O-RING
14	REC93210-53M08	93210-53M08	TÓRICA	O-RING
15	REC6G1-45362-09	6G1-45362-09	RODAMIENTO	BALL BEARING
16	REC93101-15074	93101-15074	RETÉN DE ACEITE	OIL SEAL
17	PAGB/T96-6	92995-06600	ARANDELA	WASHER
18	REC90201-10M01	90201-10M01	ARANDELA	WASHER
19	REC90171-10M01	90171-10M01	TUERCA	LOCK NUT
20	REC91490-30025	91490-30020	PASADOR ALETAS	PIN, COTTER
21	PAF15-00000013	93604-12M07	PIN CENTRADOR	HOLLOW PIN
22	REC6G1-45316-09	6G1-45316-09	RODAMIENTO	BALL BEARING
23	PAGB/T5783-M8X25	97080-08025	PERNO	STUD
24	REC93210-06ME6	93210-06ME6	TÓRICA	O-RING
25	PAF15-06020005	63V-45375-00	RETÉN DE GOMA	SEAL, RUBBER
26	REC93101-11M23	93101-11M23	RETÉN DE ACEITE	OIL SEAL
27	REC664-44338-00	664-44338-00	CUÑA	KEY WOODRUFF
28	REC68T-44323-00	68T-44323-00	JUNTA TAPA BOMBA AGUA	GASKET, WATER PUMP COVER
29	REC93210-44398	93210-44398	TÓRICA	O-RING
30	REC68T-44352-00	68T-44352-00	TURBINA BOMBA AGUA	IMPELLER, WATER PUMP
31	REC63V-44322-00	63V-44322-00	TAPA, BOMBA AGUA	COVER, INNER WATER PUMP
32	PAF15-00000013	93604-12M07	PIN CENTRADOR	HOLLOW PIN
33	REC63V-44301-00	63V-44301-00	CUERPO BOMBA AGUA	HOUSING, WATER PUMP
34	REC68T-44366-00	68T-44366-00	TUBO GOMA BOMBA AGUA	RUBBER TUBE, WATER PUMP
35	PAF15-06000014	63V-44328-00	PLACA	OUT PLATE
36	REC97080-08045	97080-08045	PERNO	STUD
37	PAF15-02000006	63V-44365-10	GOMA DEL TUBO DE AGUA	I-SHAPED RUBBER BAND
38	REC68T-45251-00AL	68T-45251-00	ÁNODO	ÁNODO



REF OEM

REC68T-W0078-00 68T-W0078-00

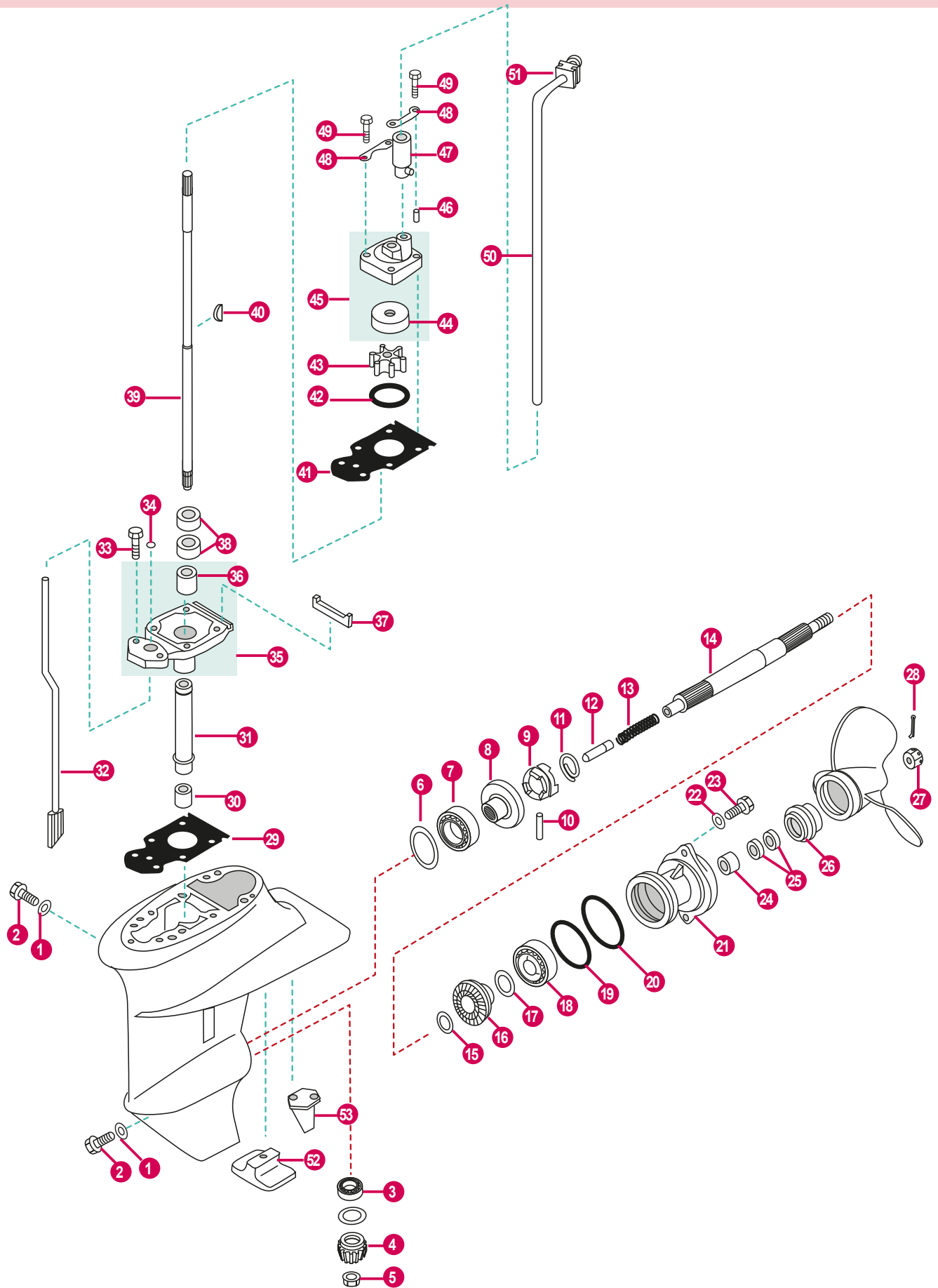

	REF	OEM		
	PAF15-0610000L	66M-45300-11-4D	COLA COMPLETA L	COMPLETE GEAR HOUSING L
	PAF15-0610000S	66M-45300-02-4D	COLA COMPLETA S	COMPLETE GEAR HOUSING S
1	REC90430-08020	90430-08020	ARANDELA	WASHER
2	REC90340-08002	90340-08002	TAPÓN ACEITE	PLUG, OIL
3	REC93341-214U1	93314-314V8	COJINETE	BEARING
4	REC63V-45551-00	63V-45551-00	PIÑÓN ATAQUE	INITIATIVE GEAR
5	REC90179-08M06	90179-08M06	TUERCA	LOCK NUT
6	PAF15-06000010-1	664-45567-01-10	GRUESO	SHIM
7	REC93332-00005	93332-00005	COJINETE	BEARING
8	REC6E7-45560-01	6E7-45560-01	PIÑÓN MARCHA AVANTE	POSITIVE GEAR ASSY
9	REC682-45631-00	682-45631-00	SELECTOR	CLUTCH BLOCK
10	REC90250-05010	90250-05010	PASADOR	PIN
11	REC648-45633-00	648-45633-00	MUELLE	SPRING
12	REC650-45635-00	650-45635-00	ÉMBOLO	PLUNGER
13	PAF15-06070002	90501-14M06	MUELLE	SPRING
14	REC683-45611-00	683-45611-00	EJE HÉLICE	PROPELLER SHAFT
15	REC90201-17682	90201-17682	ARANDELA	WASHER
16	REC6E7-45570-00	6E7-45571-00	PIÑÓN MARCHA ATRÁS	REVERSE GEAR
17	PAF15-06080006-1	626-45577-00-01	GRUESO	SHIM
18	REC93306-00501	93306-00501	COJINETE	BEARING
19	REC93210-57M09	93210-57M09	TÓRICA	O-RING
20	PAF15-06080003	93210-56M80	TÓRICA	O-RING
21	REC683-45361-01-4D	683-45361-02-4D	DIÁBOLO	CAP, LOWER CASING
22	PAGB/T96-6	92995-06600	ARANDELA	WASHER
23	PAGB/T5783-M6X20	97095-06020	TORNILLO	SCREW
24	REC93315-317U2	93315-317U2	COJINETE	BEARING
25	REC93101-17054	93101-17054	RETÉN DE ACEITE	OIL SEAL
26	REC6E7-45987-00	6E7-45987-00	ESPACIADOR	SPACER
27	REC90171-10M01	90171-10M01	TUERCA	LOCK NUT
28	REC91490-30025	91490-30020	PASADOR ALETAS	PIN, COTTER
29	REC63V-45315-A0	63V-45315-A0	JUNTA	GASKET
30	REC93315-314V8	93315-314V8	COJINETE	BEARING
31	PAF15-06000006	63V-45536-00	CAMISA EJE	SLEEVE, DRIVE
32	PAF15-06030000S	63V-44150-00	VARILLA SELECTOR S	CAM ASSY, SHIFT ROD S
	PAF15-06030000L	63V-44150-10	VARILLA SELECTOR L	CAM ASSY, SHIFT ROD L
33	PAGB/T5783-M8X25	97080-08025	TORNILLO	SCREW
34	REC93210-06ME6	93210-06ME6	TÓRICA	O-RING
35	REC63V-45331-00-5B	63V-45331-00-5B	CUERPO DEL COJINETE	SHELL, BEARING
36	REC626-45316-09	626-45316-09	CASQUILLO EJE	BUSHER, SHAFT
37	PAF15-06020005	63V-45375-00	RETÉN DE GOMA	SEAL, RUBBER
38	REC93101-20048	93101-20048	RETÉN DE ACEITE	OIL SEAL
39	PAF15-06040000S	63V-45510-00	EJE VERTICAL S	DRIVE SHAFT S
	REC63V-45501-10	63V-45510-11	EJE VERTICAL L	DRIVE SHAFT L
40	REC664-44338-00	664-44338-00	CUÑA	KEY WOODRUFF
41	REC63V-44323-00	63V-44323-00	JUNTA TAPA BOMBA AGUA	GASKET, WATER PUMP COVER
42	REC93210-44398	93210-44398	TÓRICA	O-RING
43	REC63V-44352-01	63V-44352-01	TURBINA	IMPELLER
44	REC63V-44322-00	63V-44322-00	TAPA, BOMBA AGUA	COVER, INNER WATER PUMP
45	REC63V-44301-00	63V-44301-00	CUERPO DE BOMBA	PUMP HOUSING
46	PAF15-00000013	93604-12M07	PASADOR	PIN
47	REC647-44366-00	647-44366-00	TUBO GOMA BOMBA AGUA	RUBBER TUBE, WATER PUMP
48	PAF15-06000014	63V-44328-00	PLACA	OUT PLATE
49	REC97080-08045	97080-08045	PERNO	STUD
50	PAF15-02000005S	66M-44361-00	TUBO DE AGUA S	WATER TUBE S
	PAF15-02000005L	66M-44361-10	TUBO DE AGUA L	WATER TUBE L
51	PAF15-02000006	63V-44365-10	GOMA DEL TUBO DE AGUA	I-SHAPED RUBBER BAND
52	REC61N-45251-01AL	61N-45251-01	ÁNODO	ÁNODE
53	REC66M-45371-00AL	66M-45371-00	ÁNODO	ÁNODE



REF	OEM
REC66M-W0001-20	66M-W0001-20



REF	OEM
REC63V-W0078-01	63V-W0078-01

4T F9.9H • F13.5B • F15C/M/E • F20B/E/M
STROKES

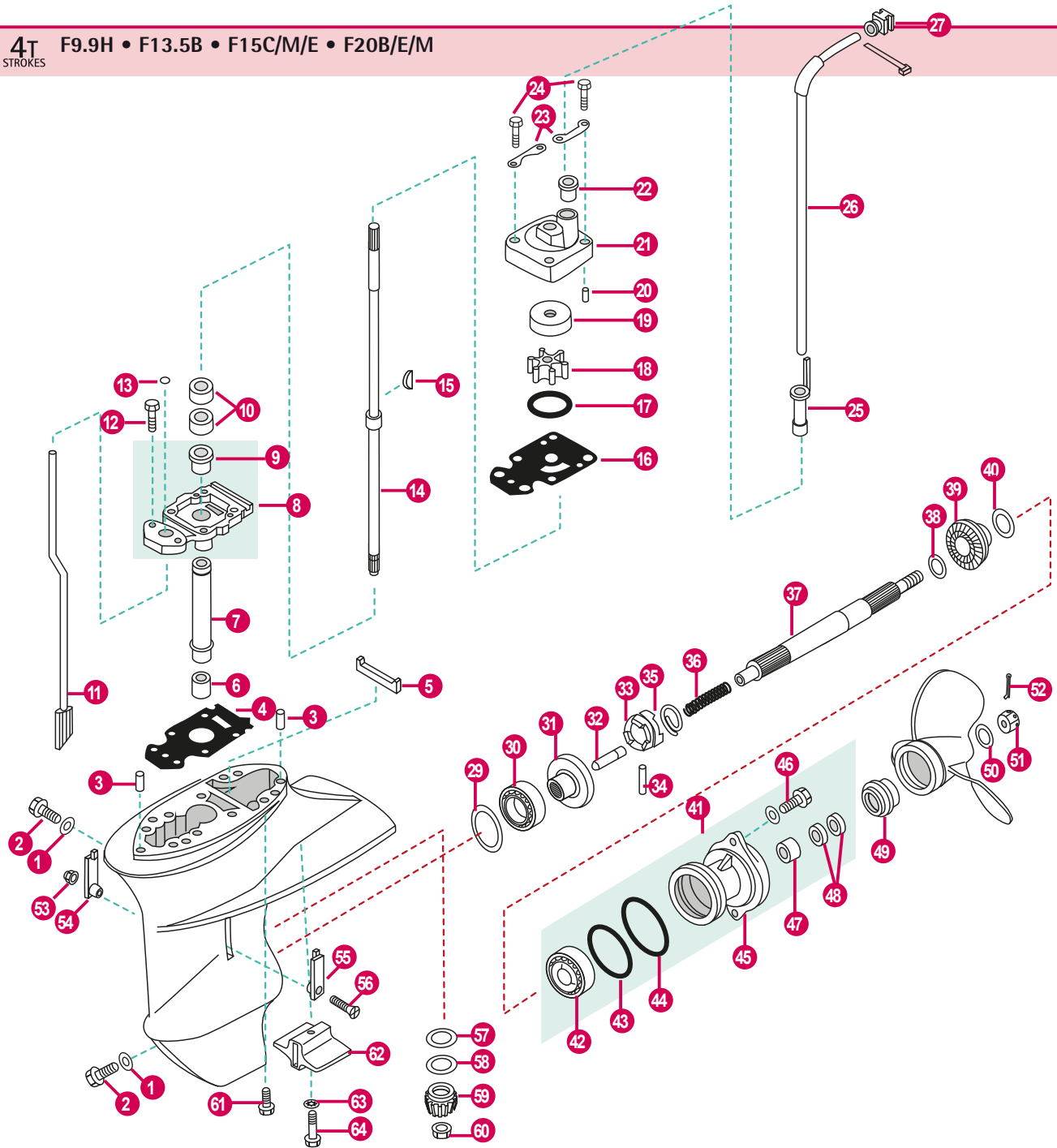

REF	OEM		
PAF20-0400000L	6AH-45300-10-8D	COLA COMPLETA L	COMPLETE GEAR HOUSING L
PAF20-0400000S	6AH-45300-00-8D	COLA COMPLETA S	COMPLETE GEAR HOUSING S
1 REC90430-08020	90430-08003	ARANDELA	WASHER
2 REC90340-08002	90340-08002	TAPÓN ACEITE	PLUG, OIL
3 PAF15-00000013	93604-12M07	PIN CENTRADOR	HOLLOW PIN
4 PAF20-04000001	69G-45315-A0	JUNTA	GASKET
5 PAF15-06020005	63V-45375-00	RETÉN DE GOMA	SEAL, RUBBER
6 REC93315-314V8	93315-314V8	RODAMIENTO	BALL BEARING
7 PAF15-06000006	63V-45536-00	CAMISA EJE	SLEEVE, DRIVE
8 PAF20-04010001	69G-45331-01-CA	CUERPO DEL COJINETE	SHELL, BEARING
9 REC626-45316-09	626-45316-09	CASQUILLO EJE	BUSHER, SHAFT
10 REC93101-20048	93101-20001	RETÉN DE ACEITE	OIL SEAL
11 PAF20-04020000S	6AH-44150-00	VARILLA SELECTOR S	CAM ASSY, SHIFT ROD S
PAF20-04020000L	6AH-44150-10	VARILLA SELECTOR L	CAM ASSY, SHIFT ROD L

	REF	OEM		
12	REC93210-06ME6	93210-06ME6	TÓRICA	O-RING
13	PAGB/T5783-M8X25	97080-08025	TORNILLO	SCREW
14	PAF20-04030000L	6AH-45510-10	EJE VERTICAL L	DRIVE SHAFT L
	PAF20-04030000S	6AH-45510-00	EJE VERTICAL S	DRIVE SHAFT S
15	REC664-44338-00	664-44338-00	CUÑA	KEY WOODRUFF
16	REC68T-44323-00	68T-44323-00	JUNTA TAPA BOMBA AGUA	GASKET, WATER PUMP COVER
17	REC93210-49046	93210-49046	TÓRICA	O-RING
18	REC63V-44352-01	63V-44352-01	TURBINA BOMBA AGUA	IMPELLER, WATER PUMP
19	REC63V-44322-00	63V-44322-00	TAPA, BOMBA AGUA	COVER, INNER WATER PUMP
20	PAF15-00000013	93604-12M07	PASADOR BOMBA AGUA	PIN, WATER PUMP
21	PAF20-04040000	6AH-44311-00	CUERPO BOMBA AGUA	HOUSING, WATER PUMP
22	REC6L2-44367-00	6L2-44367-00	TUBO GOMA BOMBA AGUA	RUBBER TUBE, WATER PUMP
23	PAF15-06000014	63V-44328-01	PLACA	OUT PLATE
24	REC97095-08045	97095-08045	PERNO	STUD
25	PAF20-02000005	6AH-44368-00	TUBO DE AGUA	WATER TUBE
26	PAF20-02000101L	6AH-44361-11	TUBO DE AGUA L	WATER TUBE L
	PAF20-02000101S	6AH-44361-01	TUBO DE AGUA S	WATER TUBE S
27	PAF20-02000007	6AH-44365-00	GOMA DEL TUBO DE AGUA	I-SHAPED RUBBER BAND
	PAF15-06000010-1	664-45567-01	GRUESO 0.10 mm	SHIM 0.10 mm
	PAF15-06000010-2	664-45567-10	GRUESO 0.12 mm	SHIM 0.12 mm
29	PAF15-06000010-3	664-45567-20	GRUESO 0.15 mm	SHIM 0.15 mm
	PAF15-06000010-5	664-45567-40	GRUESO 0.30 mm	SHIM 0.30 mm
	PAF15-06000010-6	664-45567-50	GRUESO 0.40 mm	SHIM 0.40 mm
	PAF15-06000010-7	664-45567-60	GRUESO 0.50 mm	SHIM 0.50 mm
30	REC93332-00005	93332-00005	RODAMIENTO	BALL BEARING
31	REC6E7-45560-01	6E7-45560-01	PIÑÓN MARCHA AVANTE	POSITIVE GEAR ASSY
32	REC650-45635-00	650-45635-00	ÉMBOLO	PLUNGER
33	REC682-45631-00	682-45631-00	SELECTOR	CLUTCH BLOCK
34	REC90250-05010	90250-05010	PASADOR	PIN
35	REC648-45633-00	648-45633-11	MUELLE	SPRING
36	PAF15-06070002	90501-150A0	MUELLE	SPRING
37	REC683-45611-00	683-45611-00	EJE HÉLICE	PROPELLER SHAFT
38	REC90201-17682	90201-17682	ARANDELA	WASHER
39	REC6E7-45570-00	6E7-45570-00	PIÑÓN MARCHA ATRÁS	REVERSE GEAR
	PAF15-06080006-1	626-45577-00	GRUESO 0.10 mm	SHIM 0.10 mm
	PAF15-06080006-2	626-45577-10	GRUESO 0.20 mm	SHIM 0.20 mm
40	PAF15-06080006-3	626-45577-20	GRUESO 0.30 mm	SHIM 0.30 mm
	PAF15-06080006-4	626-45577-30	GRUESO 0.40 mm	SHIM 0.40 mm
	PAF15-06080006-5	626-45577-40	GRUESO 0.50 mm	SHIM 0.50 mm
41	PAF15-06080000	683-45361-02-8D	FUNDA INFERIOR COMPLETA	COVER ASSY, LOWER CASING
42	REC93306-00501	93306-00501	COJINETE	BEARING
43	REC93210-57M09	93210-57M09	TÓRICA	O-RING
44	PAF15-06080003	93210-56M80	TÓRICA	O-RING
45	REC683-45361-01-4D	683-45361-02-8D	DIÁBOLO	CAP, LOWER CASING
46	PAGB/T5783-M6X20	97575-06520	TORNILLO	SCREW
47	REC93315-317U2	93315-317U2	COJINETE	BEARING
48	REC93101-17054	93101-17054	RETÉN DE ACEITE	OIL SEAL
49	REC6E7-45987-00	6E7-45987-01	ESPACIADOR	SPACER
50	PAGB/T96-10	90201-10M01	ARANDELA	WASHER
51	REC90171-10M01	90171-10M01	TUERCA	LOCK NUT
52	REC91490-30025	94190-30020	PASADOR ALETAS	PIN, COTTER
53	PAGB/T6182-M5	90185-05002	TUERCA	LOCK NUT
54	PAF15-06000002	63V-45215-00	CUBIERTA, ENTRADA AGUA 2	WATER INLET A
55	PAF15-06000003	6G1-45214-00	CUBIERTA, ENTRADA AGUA 1	WATER INLET B
56	PAGB/T820-M5X20	90152-05011	TORNILLO	SCREW
57	PAF15-06000020-1	90201-15017	ARANDELA	WASHER
58	PAF15-06000009	6E8-45587-30	GRUESO 1.20 mm	SHIM 1.20 mm
59	REC63V-45551-00	63V-45551-00	PIÑÓN ATAQUE	INITIATIVE GEAR
60	REC90179-08M06	90179-08M06	TUERCA	LOCK NUT
61	PAGB/T5783-M8X30	97575-08530	PERNO	STUD
62	REC6AH-45251-00AL	6AH-45251-00	ÁNODO	ANODE
63	PAGB/T861.1-6	92990-06300	ARANDELA	WASHER
64	PAGB/T5783-M6X30	95895-06035	TORNILLO	SCREW

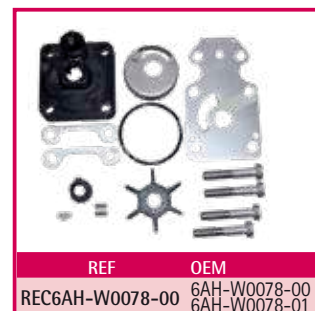

REF	OEM
REC6AH-W0078-00	6AH-W0078-00 6AH-W0078-01

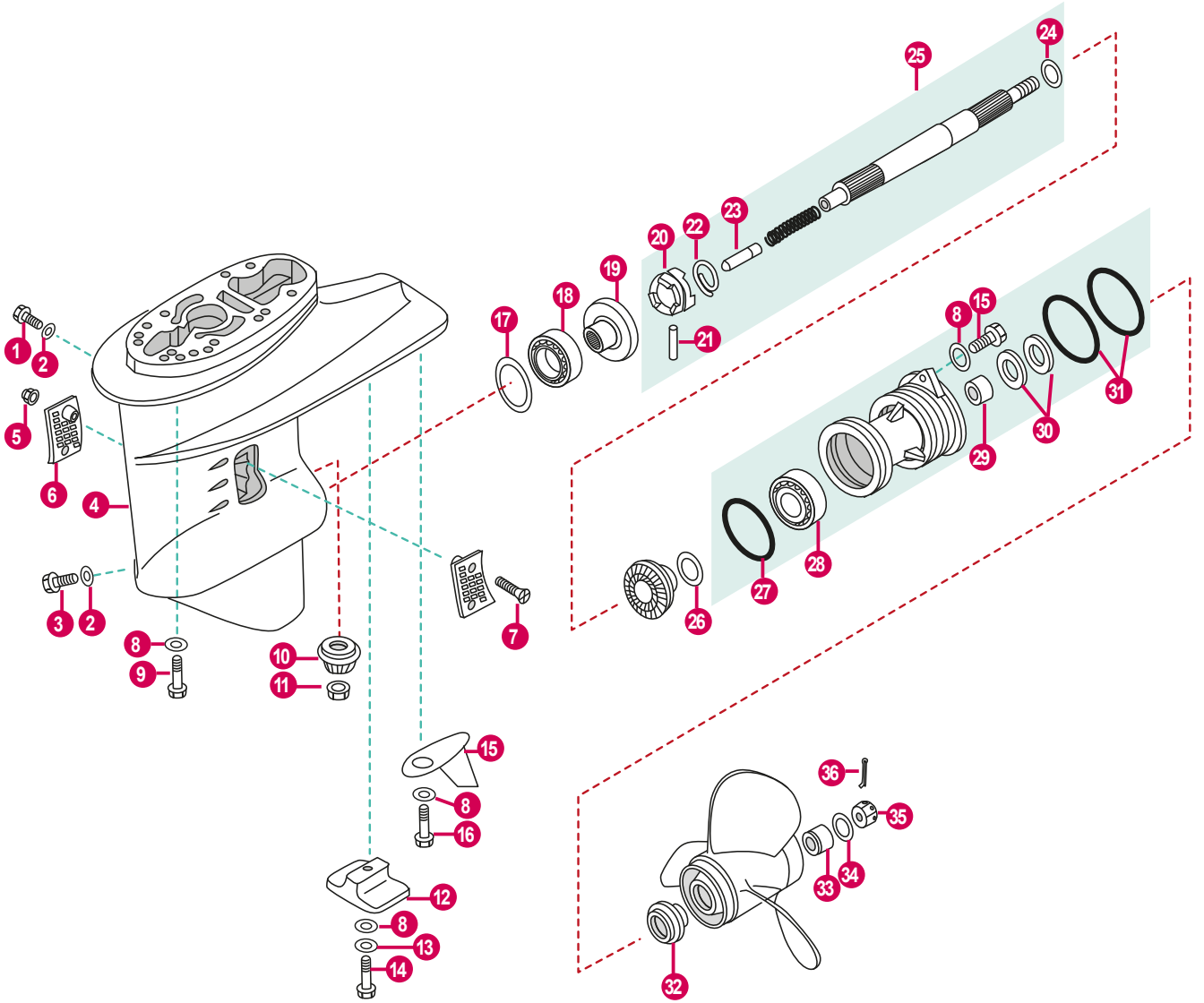

	REF	OEM		
	PAF25-04090000L	65W-45300-10-4D	COLA COMPLETA L	COMPLETE GEAR HOUSING L
	PAF25-04090000S	65W-45300-00-4D	COLA COMPLETA S	COMPLETE GEAR HOUSING S
1	REC90340-08002	90340-08M04	TAPÓN ACEITE	PLUG, OIL
2	REC90430-08020	93210-06ME6	JUNTA	GASKET
3	REC688-45341-00	688-45341-00	TAPÓN DE DESAGÜE	PLUG, DRAIN
4	PAF25-04000001	61N-45311-02-4D	CARTER	LOWER CASING
5	PAGB/T889.1-2000	90185-05002	TUERCA	NUT, LOCKING
6	PAF25-04000023	6L2-45215-00	CUBIERTA ENTRADA AGUA B	WATER INLET B
7	PAGB/T820-M5X30	90151-05M05	TORNILLO	SCREW, PAN HEAD
8	PAGB/T97.1-8	92995-10600	ARANDELA	WASHER
9	PAF25-00000011	90105-10M12	TORNILLO	BOLT
10	PAF25-04000005	61N-45551-00	PIÑÓN ATAQUE	INITIATIVE GEAR
11	REC90179-10M14	90179-10M14	TUERCA	NUT, PINION
12	PAF15-06000004	61N-45251-00	ÁNODO	ANODE, LOWER
13	PAGB/T861.1-87	92990-06300	ARANDELA	WASHER, LOCKING
14	PAGB/T5782-M6X125	95895-06035	TORNILLO	BOLT
15	PAF25-04000021	61N-45214-00	PLACA TIMÓN	TAB, COURSE
16	PAGB/T5783-M5X12	90119-06M48	TORNILLO	BOLT
17	PAF25-04000004-3	6L2-45567-12	GRUESO 1.2 mm	SHIM 1.2 mm
	PAF25-04000004-5	6L2-45567-14	GRUESO 1.4mm	SHIM 1.4 mm
18	REC93332-00005	93332-00005	RODAMIENTO	BALL BEARING
19	REC61N-45560-10	61N-45560-00	PIÑÓN MARCHA AVANTE	POSITIVE GEAR ASSY
20	PAF25-04060003	664-45631-02	SELECTOR	CLUTCH BLOCK
21	REC90250-05010	90250-05010	PASADOR	PIN
22	REC648-45633-00	648-45633-00	MUELLE	SPRING
23	REC648-45635-00	648-45635-00	ÉMBOLO	PLUNGER
24	PAF25-04060007	90201-20417	GRUESO	SHIM
25	PAF25-04060000	648-45633-11	EJE HÉLICE COMPELTO	PROPELLER, SHAFT ASSY
26	PAF25-04070005-1	6L2-45577-00-10	GRUESO 1.0 mm	SHIM 1.0 mm
	PAF25-04070005-3	6L2-45577-00-12	GRUESO 1.2 mm	SHIM 1.2 mm
27	REC93210-64ME7	93210-64ME7	TÓRICA	O-RING
28	PAGB/T276-6006/P6	93306-00612	RODAMIENTO	BALL BEARING
29	REC93315-22004	93315-22004	RODAMIENTO	BALL BEARING
30	REC93101-20M07	93101-20M07	RETÉN DE ACEITE	OIL SEAL
31	REC93210-65M50	93210-65M50	TÓRICA	O-RING
32	REC6L2-45987-00	6L2-45987-01	ESPACIADOR	SPACER, PROPELLER
33	REC689-45997-00	689-45997-00	ESPACIADOR	SPACER
34	PAGB/T97.1-8	92990-14200	ARANDELA	WASHER
35	REC90171-14013-00	90171-14013	TUERCA	NUT
36	PAGB/T91-1.6X12	91490-30022	PIN	PIN, COTTER

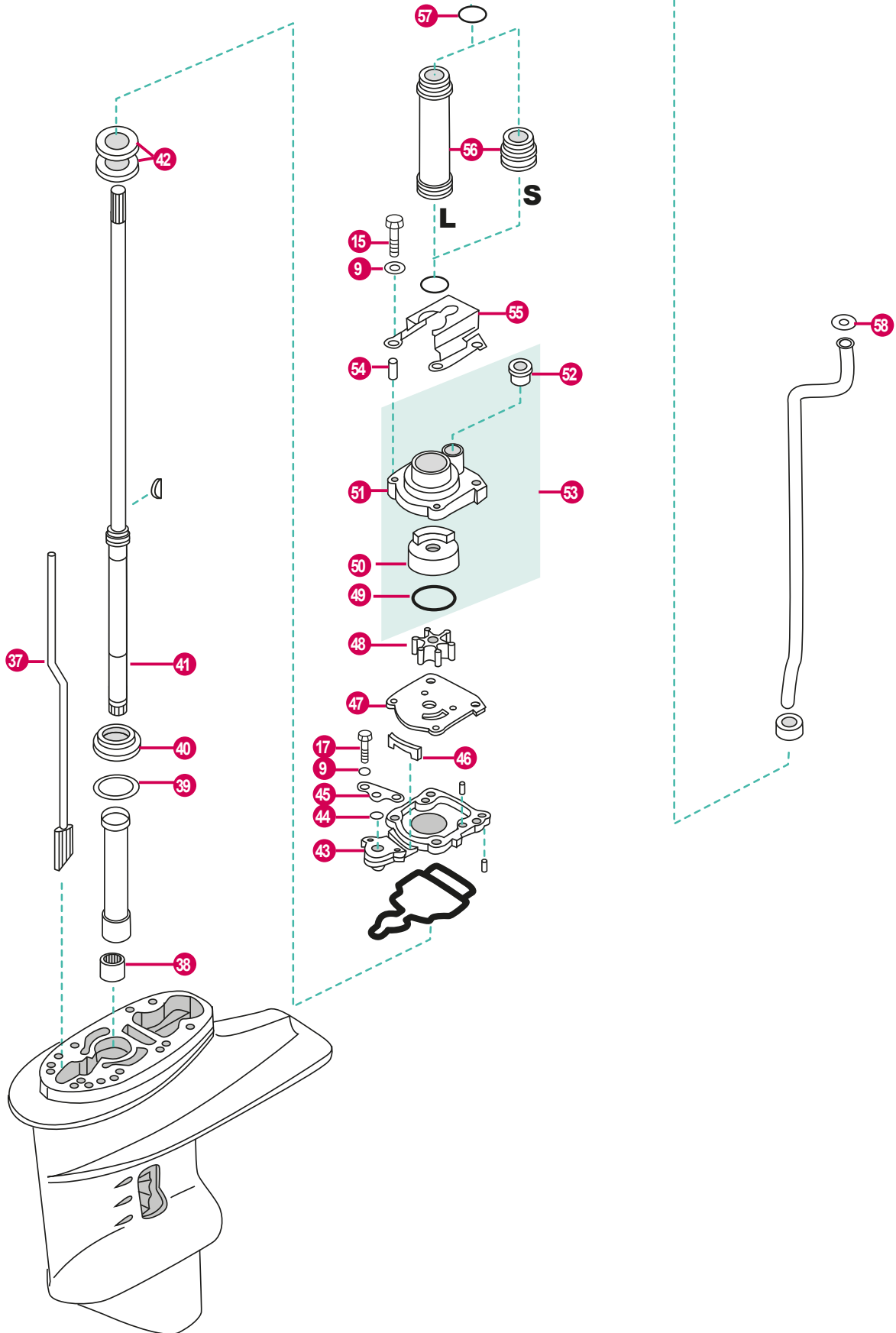

	REF	OEM		
37	PAF25-04030000S	65W-44150-00	VARILLA SELECTOR S	CAM ASSY, SHIFT ROD S
38	PAGB/T290F-2020	93315-220V7	RODAMIENTO	BALL BEARING
	PAF25-04000003-2	61N-45587-00-10	GRUESO 1.0 mm	SHIM 1.0 mm
	PAF25-04000003-3	61N-45587-00-11	GRUESO 1.1 mm	SHIM 1.1 mm
39	PAF25-04000003-4	61N-45587-00-12	GRUESO 1.2 mm	SHIM 1.2 mm
	PAF25-04000003-5	61N-45587-00-13	GRUESO 1.3 mm	SHIM 1.3 mm
	PAF25-04000003-6	61N-45587-00-14	GRUESO 1.4mm	SHIM 1.4 mm
	PAF25-04000003-7	61N-45587-00-15	GRUESO 1.5mm	SHIM 1.5 mm
40	PAHI-CAP32004JRKoyo	93332-000W5	CUERPO RODAMIENTO	HOUSING, BEARING
41	REC61N-45510-10	61N-45510-10	EJE VERTICAL L	DRIVE SHAFT L
	REC61N-45510-00	61N-45510-00	EJE VERTICAL S	DRIVE SHAFT S
42	REC93101-22M00	93101-22067	RETÉN DE ACEITE	OIL SEAL
43	PAF25-04000008	65W-45331-00-5B	BASE EJE VERTICAL	BASE, DRIVE SHAFT
44	REC93210-06ME6	93210-06ME6	TÓRICA	O-RING
45	PAF25-04000012	65W-44176-00	PLACA	OUT PLATE
46	PAF25-04000013	61N-45127-00	RETÉN AGUA	WATER SEAL
47	REC61N-44323-00	61N-44323-00	JUNTA TAPA BOMBA AGUA	GASKET, WATER PUMP COVER
48	REC6H4-44352-02	6H4-44352-02	TURBINA BOMBA AGUA	IMPELLER, WATER PUMP
49	PAF25-04050003	93210-45161	TÓRICA	O-RING
50	REC61N-44322-00	61N-44322-01	ACOPLE INOX	INSERT CARTRIDGE
51	PAF25-04050001	61N-44311-01	CUERPO BOMBA	SHELL, WATER PUMP
52	REC6L2-44367-00	6L2-44367-00	RETÉN TUBO AGUA	DAMPER, WATER PIPE
53	PAF25-04050000	61N-44311-01	KIT CUERPO BOMBA	SHELL ASSY, WATER PUMP
54	REC93606-12019	93606-11M24	PIN	PIN, DOWEL
55	PAF25-04000016	65W-44328-00	PLATO FIJO BOMBA AGUA	FIXED PLATE, WATER PUMP
56	PAF25-04000017	61N-44362-10	TUBO DE AGUA L	WATER TUBE L
	PAF25-04000017S	61N-44362-00	TUBO DE AGUA S	WATER TUBE S
57	REC90430-12072	90430-12072	JUNTA AGUA	GASKET, WATER PIPE
58	PAF25-02000019	90202-12060	ARANDELA	WASHER, NYLON



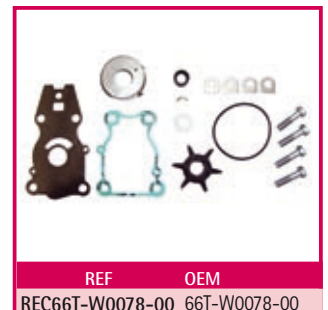
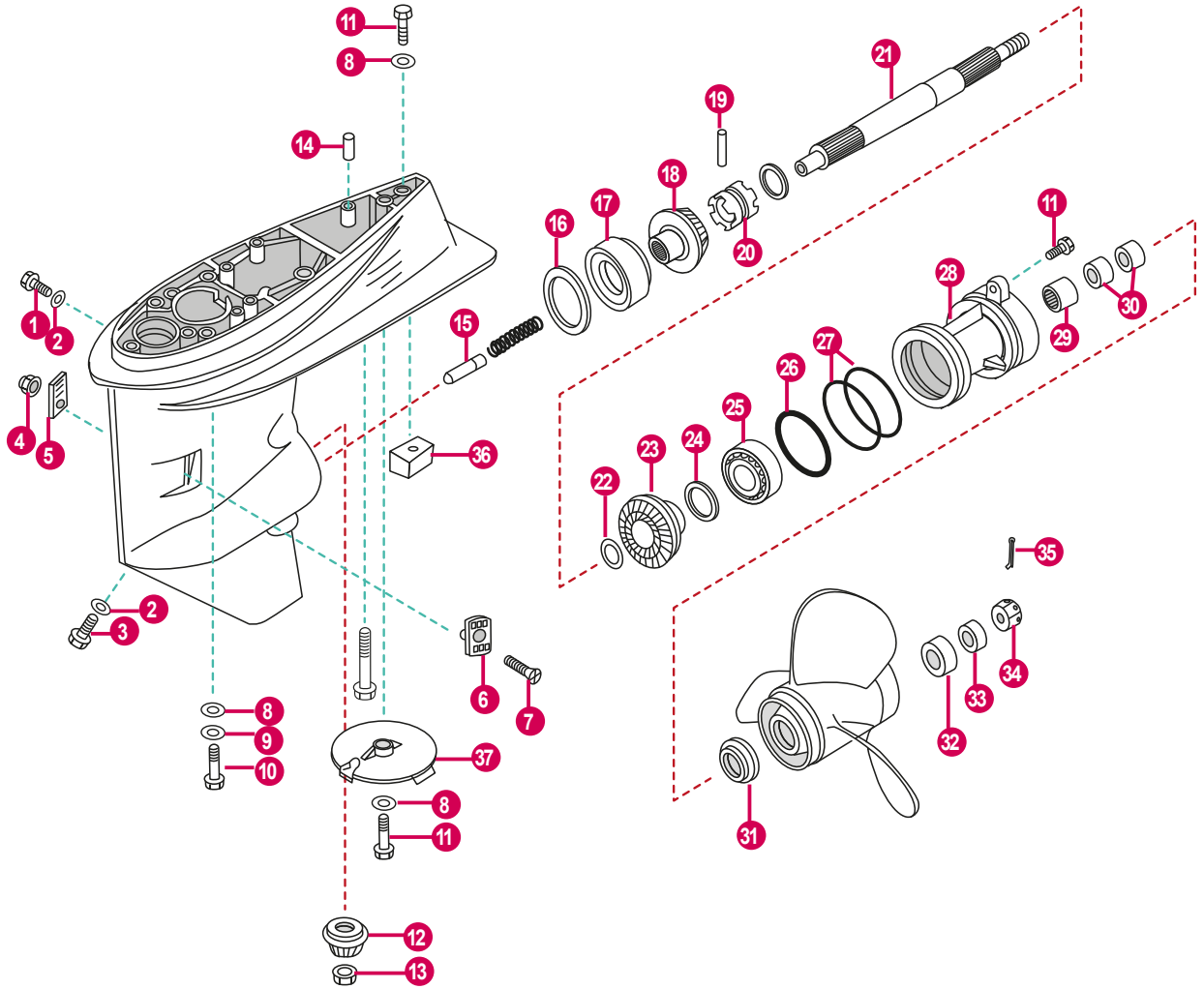

REF	OEM
REC66T-W0078-00	66T-W0078-00

	REF	OEM		
1	REC90340-08002	90340-08002	TAPÓN ACEITE	PLUG, OIL
2	REC90430-08020	90430-08020	JUNTA	GASKET
3	REC688-45341-00	688-45341-10	TAPÓN ACEITE	PLUG, OIL
4	PAGB/T889.1-M5	95380-05600	TUERCA	LOCK NUT
5	PAT40-04000023	63D-45215-00	CUBIERTA ENTRADA AGUA B	WATER INLET B
6	PAT40-04000022	63D-45214-00	CUBIERTA ENTRADA AGUA A	WATER INLET A
7	PAGB/T820-M5X30	90142-05M06	TORNILLO	SCREW
8	PAGB/T97.1-8	92995-10600	ARANDELA	WASHER
9	PAGB/T97.1-10	92995-10100	ARANDELA	WASHER
10	REC97075-10040	97075-10040	PERNO	STUD
11	PAGB/T5783-M8X25	97095-08025	PERNO	STUD
12	REC66T-45551-00	66T-45551-00	PIÑÓN ATAQUE	INITIATIVE GEAR
13	REC90170-12138	90170-12138	TUERCA	LOCK NUT
14	REC93606-12019	93606-12019	PASADOR	PIN
15	REC66T-45635-00	66T-45635-00	ÉMBOLO	PLUNGER
16	PAT40-04000004-1	663-45567-01	GRUESO 0.10 mm	SHIM 0.10 mm
	PAT40-04000004-5	663-45567-40	GRUESO 0.30 mm	SHIM 0.30 mm
17	REC93332-00003	93332-00003	COJINETE	BEARING
18	REC66T-45560-00	66T-45560-01	PIÑÓN MARCHA AVANTE	POSITIVE GEAR ASSY
19	REC90250-06023	90250-06023	PASADOR	PIN
20	REC66T-45631-00	66T-45631-00	SELECTOR	CLUTCH BLOCK
21	REC66T-45611-00	66T-45611-00	EJE HÉLICE	PROPELLER SHAFT
22	REC90201-22429	90201-22429	ARANDELA	WASHER
23	REC66T-45571-00	66T-45571-00	PIÑÓN MARCHA ATRÁS	REVERSE GEAR
	PAT40-04060005-2	63D-45577-10	GRUESO 0.12 mm	SHIM 0.12 mm
24	PAT40-04060005-3	63D-45577-20	GRUESO 0.15 mm	SHIM 0.15 mm
	PAT40-04060005-4	63D-45577-30	GRUESO 0.18 mm	SHIM 0.18 mm
	PAT40-04060005-5	63D-45577-40	GRUESO 0.30 mm	SHIM 0.30 mm
25	REC93306-001U1	93306-001U1	COJINETE	BEARING
26	REC93210-69MG6	93210-69MG6	TÓRICA	O-RING
27	REC93210-74MG5	93210-74MG5	TÓRICA	O-RING
28	REC63D-45361-02-4D	63D-45361-02-4D	DIÁBOLO	CAP, LOWER CASING
29	REC93317-22204	93317-22204	COJINETE	BEARING
30	REC93101-22M00	93101-22M00	RETÉN DE ACEITE	OIL SEAL
31	REC663-45987-00	663-45987-02	ESPACIADOR	SPACER
32	REC66T-45997-00	66T-45997-00	ESPACIADOR	SPACER
33	REC90389-22M01	90389-22M01	CASQUILLO HÉLICE	WASHER
34	REC90171-16011	90171-16011	TUERCA	LOCK NUT
35	REC91490-30025	91490-30025	PASADOR	PIN
36	REC67C-45251-00AL	67C-45251-00	ÁNODO	ÁNODO
37	REC67C-45371-00AL	67C-45371-00	ÁNODO	ÁNODO

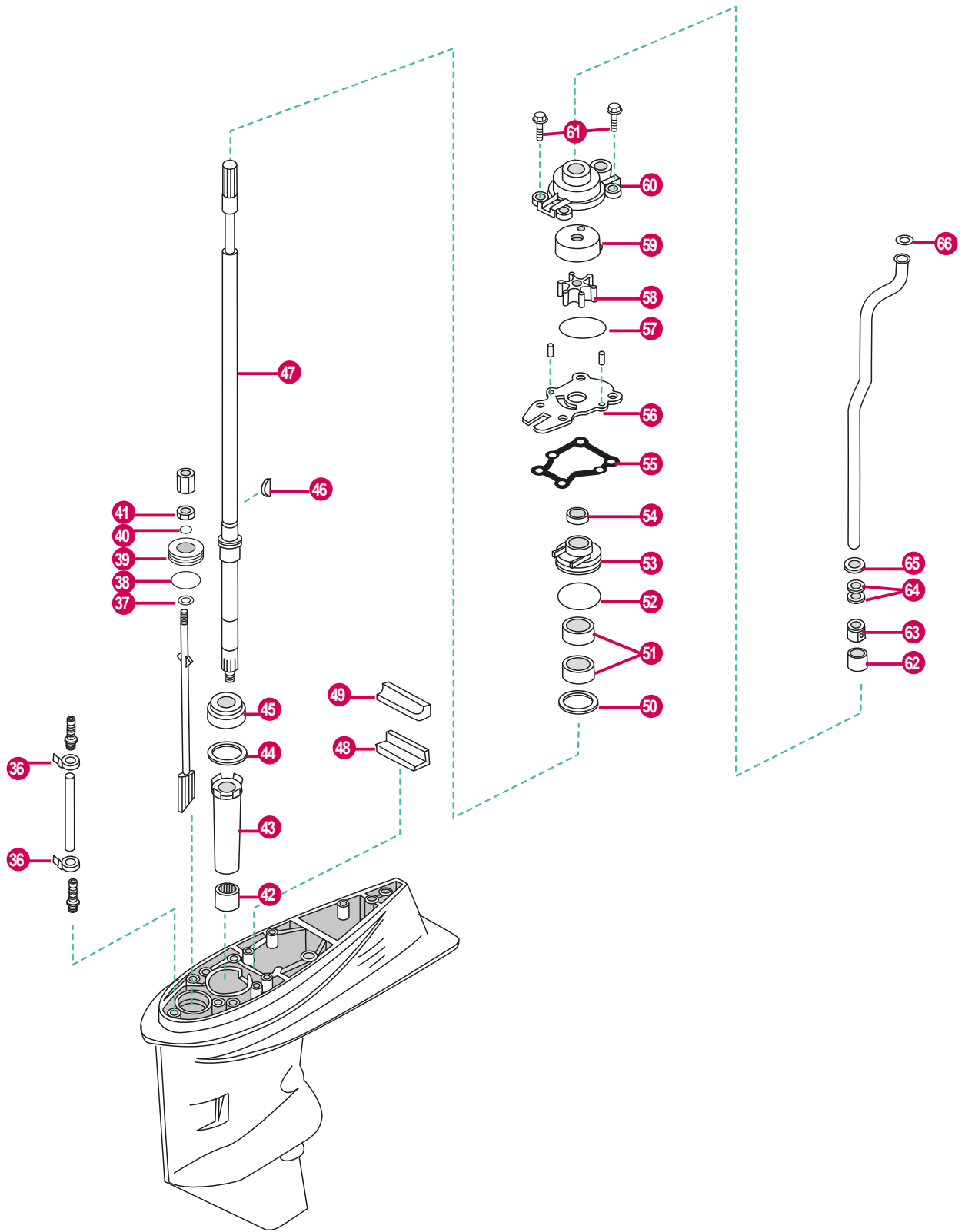

	REF	OEM		
36	PAHT-2.5X60	90465-11M10	BRIDA	CLAMP
37	PAGB/T96-6	92990-06600	ARANDELA	WASHER
38	REC93210-33MG4	93210-33MG4	TÓRICA	O-RING
39	PAT40-04000007	66T-45321-00	PLACA	COVER PLATE, CAMSHAFT
40	REC93210-06ME6	93210-06ME6	TÓRICA	O-RING
41	REC95380-06700	95380-06700	TUERCA	LOCK NUT
42	REC93315-32224	93315-32224	COJINETE	BEARING
43	PAT40-04000002	6H4-45536-00	CAMISA EJE	SLEEVE, DRIVE
	PAT40-04000003-1	663-45587-01	GRUESO 0.10 mm	SHIM 0.10 mm
	PAT40-04000003-2	663-45587-10	GRUESO 0.12 mm	SHIM 0.12 mm
44	PAT40-04000003-3	663-45587-20	GRUESO 0.15 mm	SHIM 0.15 mm
	PAT40-04000003-5	663-45587-40	GRUESO 0.30 mm	SHIM 0.30 mm
45	REC93332-00001	93332-00001	COJINETE	BEARING
46	REC90280-03M03	90280-03M03	CHAVETA	KEY WOODRUFF
	PAF40-04010000L	67C-45501-10	EJE VERTICAL L	DRIVE SHAFT L
47	PAF40-04010000S	67C-45501-00	EJE VERTICAL S	DRIVE SHAFT S
48	REC663-45376-00	663-45376-00-94	GUÍA SELLO DE GOMA	GUIDE RUB. SEAL
49	PAT40-04000014	63D-45375-00	SELLO DE GOMA	WATER ENVELOP
50	PAT40-04000008	90201-27M00	ARANDELA	WASHER
51	REC93101-22M60	93101-22M60	RETÉN DE ACEITE	OIL SEAL
52	REC93210-48MG8	93210-48MG8	TÓRICA	O-RING
53	REC63D-44341-00	63D-44341-00	CUERPO BOMBA DE AGUA	SHELL, WATER PUMP
54	PAT40-04000009	66T-45344-01	CUBIERTA SELLO DE ACEITE	COVER, OIL SEAL
55	REC63D-44316-00	63D-44316-00	JUNTA	GASKET
56	REC66T-44323-00	66T-44323-00	PLACA EXTERIOR	OUTER PLATE
57	REC93210-59MG7	93210-59MG7	TÓRICA	O-RING
58	REC6H4-44352-02	6H4-44352-02	TURBINA	IMPELLER
59	REC63D-44322-00	63D-44322-00	TAPA, BOMBA AGUA	COVER, INNER WATER PUMP
60	PAT40-04000201	66T-44311-00	CUERPO BOMBA AGUA	HOUSING, WATER PUMP
61	REC90119-08M15	90119-08M15	TORNILLO CON ARANDELA	SCREW WITH WASHER
62	REC663-44366-00	663-44366-00	GOMA DEL SELLO DE AGUA	DAMPER, WATER SEAL
63	REC63D-44312-00	63D-44312-00	CUBIERTA CAJA DE BOMBA DE AGUA	PUMP COVER
64	PAT40-02000002	663-44367-00	GOMA DEL SELLO DE AGUA	GUIDE BUSHING, WATER PIPE
65	REC90430-12072	90430-12072	JUNTA	GASKET
66	PAF25-02000019	90202-12060	ARANDELA PLANA	WASHER

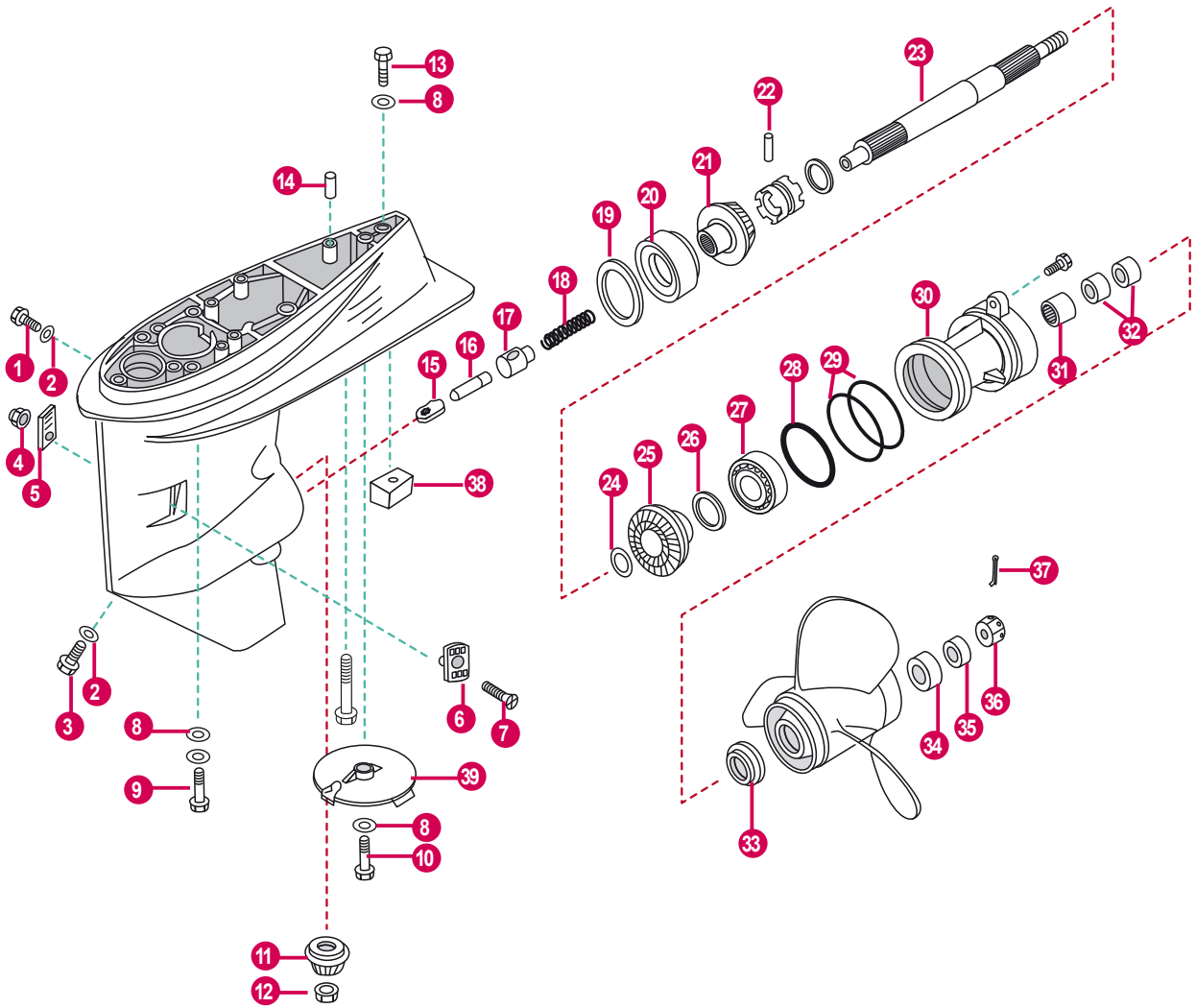

REF	OEM
REC6BG-W0078-00	6BG-W0078-00

	REF	OEM		
1	REC90340-08002	90340-08002	TORNILLO DRENAJE	BOLT, DISCHARGING OIL
2	REC90430-08020	90430-08003	JUNTA	GASKET
3	REC688-45341-00	688-45341-10	TORNILLO DRENAJE	BOLT, DISCHARGING OIL
4	PAGB/T889.1-M5	95380-05600	TUERCA	LOCK NUT
5	PAT40-04000023	63D-45215-00	CUBIERTA ENTRADA AGUA B	WATER INLET B
6	PAT40-04000022	63D-45214-00	CUBIERTA ENTRADA AGUA A	WATER INLET A
7	PAGB/T820-M5X30	90152-05010	TORNILLO	SCREW
8	PAGB/T97.1-8	92995-10600	ARANDELA	WASHER
9	REC97075-10040	97075-10040	PERNO	STUD
10	PAGB/T5783-M8X25	97095-08025	PERNO	STUD
11	REC66T-45551-00	667-45551-00	PIÑÓN ATAQUE	INITIATIVE GEAR
12	REC90170-12138	90170-12138	TUERCA	LOCK NUT
13	PAGB/T5783-M8X35	97095-08035	PERNO	STUD
14	REC93606-12019	93606-12019	PASADOR	PIN
15	PAF60-04000003	62Y-44151-00	LEVA DE CAMBIO	SHIFTING CAM
16	PAF60-04020005	63D-45635-00	ÉMBOLO	PLUNGER
17	REC663-45634-00	663-45634-00	DESILIZADOR DEL CAMBIO	CLUTCH DOG
18	PAF60-04020002	90501-18001	MUELLE	SPRING
19	PAT40-04000004-1	663-45567-01	GRUESO 0.10 mm	SHIM 0.10 mm
	PAT40-04000004-5	663-45567-40	GRUESO 0.30 mm	SHIM 0.30 mm
20	REC93332-00003	93332-00003	COJINETE	BEARING
21	REC66T-45560-00	66T-45560-01	PIÑÓN MARCHA AVANTE	POSITIVE GEAR ASSY
22	REC90250-06023	90250-06023	PASADOR	PIN
23	PAF60-04020001	63D-45611-00	EJE HÉLICE	PROPELLER SHAFT
24	REC90201-22429	90201-22429	ARANDELA	WASHER
25	REC66T-45571-00	667-45571-00	PIÑÓN MARCHA ATRÁS	REVERSE GEAR
	PAT40-04060005-2	63D-45577-10	GRUESO 0.12 mm	SHIM 0.12 mm
26	PAT40-04060005-3	63D-45577-20	GRUESO 0.15 mm	SHIM 0.15 mm
	PAT40-04060005-4	63D-45577-30	GRUESO 0.18 mm	SHIM 0.18 mm
	PAT40-04060005-5	63D-45577-40	GRUESO 0.30 mm	SHIM 0.30 mm
27	REC93306-001U1	93306-001U1	COJINETE	BEARING
28	REC93210-69MG6	93210-69MG6	TÓRICA	O-RING
29	REC93210-74MG5	93210-74MG5	TÓRICA	O-RING
30	REC63D-45361-02-4D	63D-45361-02-8D	DIÁBOLO	CAP, LOWER CASING
31	REC93317-22204	93317-22204	COJINETE	BEARING
32	REC93101-22M00	93101-22M00	RETÉN DE ACEITE	OIL SEAL
33	REC663-45987-00	663-45987-02	ESPACIADOR	SPACER
34	REC66T-45997-00	667-45997-00	ESPACIADOR	SPACER
35	REC90389-22M01	90389-22M01	CASQUILLO HELICE	WASHER
36	REC90171-16011	90171-16011	TUERCA	LOCK NUT
37	REC91490-30025	91490-30025	PASADOR	PIN
38	REC67C-45251-00AL	67C-45251-00	ÁNODO	ÁNODO
39	REC67C-45371-00AL	67C-45371-00	ÁNODO	ÁNODO

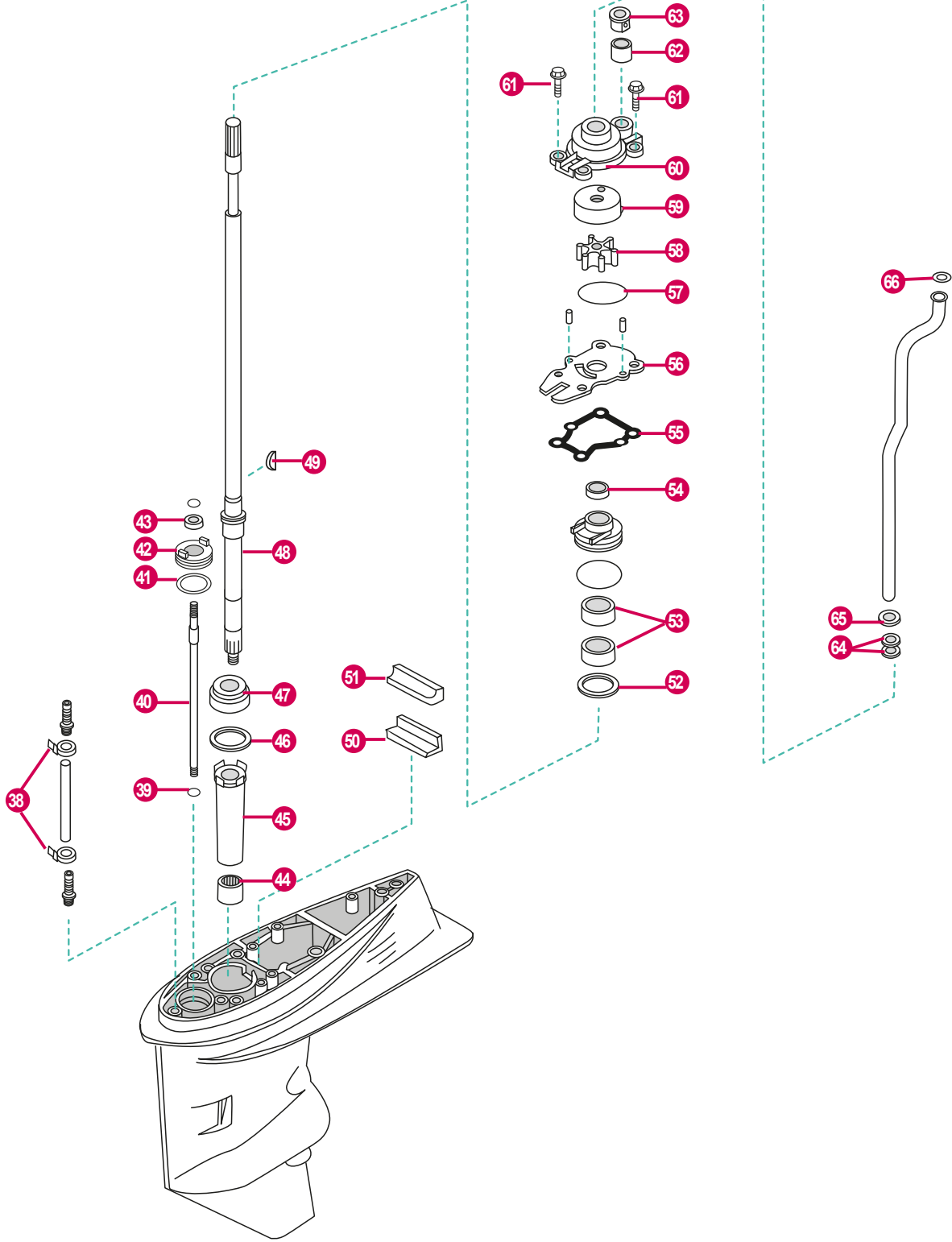

	REF	OEM		
38	PAHT-2.5X60	90465-11M10	BRIDA	CLAMP
39	REC99001-08600-00	99001-08600	ARANDELA	WASHER
40	PAG60-04000004	63D-44144-00	VARILLA DE CAMBIO	SHIFTING CAM
41	REC93210-33MG4	93210-33MG4	TÓRICA	O-RING
42	PAF60-04000101	63D-45321-00	PLACA	COVER, SHIFTING CAM
43	REC93106-09014	93106-09014	RETÉN DE ACEITE	OIL SEAL
44	REC93315-32224	93315-32224	COJINETE	BEARING
45	PAT40-04000002	6H4-45536-00	CAMISA EJE	SLEEVE, DRIVE
	PAT40-04000003-1	663-45587-01	GRUESO 0.10 mm	SHIM 0.10 mm
46	PAT40-04000003-2	663-45587-10	GRUESO 0.12 mm	SHIM 0.12 mm
	PAT40-04000003-3	663-45587-20	GRUESO 0.15 mm	SHIM 0.15 mm
	PAT40-04000003-5	663-45587-40	GRUESO 0.30 mm	SHIM 0.30 mm
47	REC93332-00001	93332-00001	COJINETE	BEARING
48	PAF40-04010000L	67C-45501-10	EJE VERTICAL L	DRIVE SHAFT L
	PAF40-04010000S	67C-45501-00	EJE VERTICAL S	DRIVE SHAFT S
49	REC90280-03M03	90280-03M03	CUÑA	KEY WOODRUFF
50	REC663-45376-00	663-45376-00	GUÍA SELLO DE GOMA	GUIDE RUB. SEAL
51	PAT40-04000014	63D-45375-00	SELLO DE GOMA	WATER ENVELOP
52	PAT40-04000008	90201-27M00	ARANDELA	WASHER
53	REC93101-22M60	93101-22M60	RETÉN DE ACEITE	OIL SEAL
54	PAT40-04000009	66T-45344-01	CUBIERTA SELLO DE ACEITE	COVER, OIL SEAL
55	REC63D-44316-00	63D-44316-00	JUNTA	GASKET
56	REC63D-44323-00	63D-44323-00	PLACA EXTERIOR	OUTER PLATE
57	REC93210-59MG7	93210-59MG7	TÓRICA	O-RING
58	REC6H4-44352-02	6H4-44352-02	TURBINA	IMPELLER
59	REC63D-44322-00	63D-44322-00	TAPA, BOMBA AGUA	COVER, INNER WATER PUMP
60	PAT40-04000201	66T-44311-00	CUERPO BOMBA AGUA	HOUSING, WATER PUMP
61	REC90119-08M15	90119-08M15	TORNILLO CON ARANDELA	SCREW WITH WASHER
62	REC663-44366-00	663-44366-00	GOMA DEL SELLO DE AGUA	DAMPER, WATER SEAL
63	REC63D-44312-00	63D-44312-00	CUBIERTA CAJA DE BOMBA DE AGUA	PUMP COVER
64	PAT40-02000002	663-44367-00	GOMA DEL SELLO DE AGUA	DAMPER, WATER SEAL
65	REC90430-12072	90430-12072	JUNTA	GASKET
66	PAF25-02000019	90202-12060	ARANDELA PLANA	WASHER

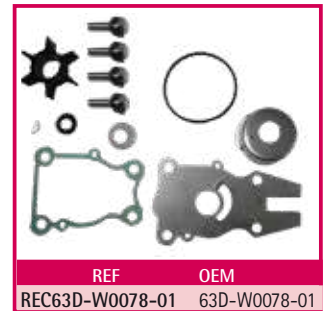
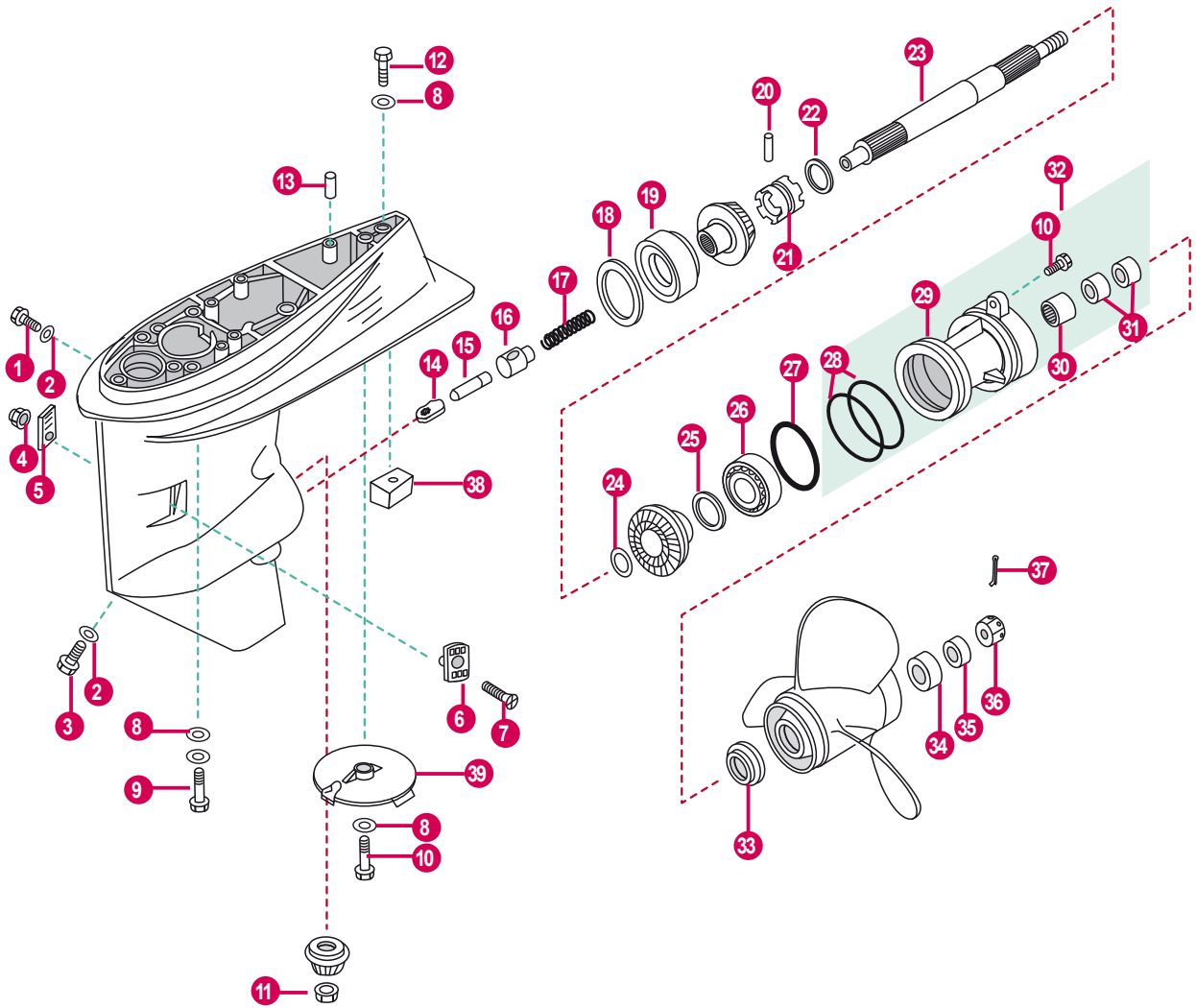

	REF	OEM		
1	REC90340-08002	90340-08002	TORNILLO DRENAJE	BOLT, DISCHARGING OIL
2	REC90430-08020	90430-08003	JUNTA	GASKET
3	REC688-45341-00	688-45341-10	TORNILLO DRENAJE	BOLT, DISCHARGING OIL
4	PAGB/T889.1-M5	95380-05600	TUERCA	LOCK NUT
5	PAT40-04000023	63D-45215-00	CUBIERTA ENTRADA AGUA B	WATER INLET B
6	PAT40-04000022	63D-45214-00	CUBIERTA ENTRADA AGUA A	WATER INLET A
7	PAGB/T820-M5X30	90152-05M06	TORNILLO	SCREW
8	PAGB/T97.1-8	92995-10600	ARANDELA	WASHER
9	REC97075-10040	97075-10040	PERNO	STUD
10	PAGB/T5783-M8X25	97095-08025	PERNO	STUD
11	REC90170-12138	90170-12138	TUERCA	LOCK NUT
12	PAGB/T5783-M8X35	97095-08035	PERNO	STUD
13	REC93606-12019	93606-12019	PASADOR	PIN
14	PAF60-04000003	62Y-44151-00	LEVA DE CAMBIO	SHIFTING CAM
15	PAF60-04020005	63D-45635-00	ÉMBOLO	PLUNGER
16	REC663-45634-00	663-45634-00	DESILIZADOR DEL CAMBIO	CLUTCH DOG
17	PAF60-04020002	90501-18001	MUELLE	SPRING
18	PAT40-04000004-1	663-45567-01	GRUESO 0.10 mm	SHIM 0.10 mm
	PAT40-04000004-5	663-45567-40	GRUESO 0.30 mm	SHIM 0.30 mm
19	REC93332-00003	93332-00003	COJINETE	BEARING
20	REC90250-06023	90250-06023	PASADOR	PIN
21	PAF60-04020003	62Y-45631-00	EMBRAGUE DE GARRA	CLUTCH DOG
22	PAT40-04050005	67C-45633-00	ANILLO DEL PASADOR	ANNULAR SPRING, CLUTCH
23	PAF60-04020001	63D-45611-00	EJE HÉLICE	PROPELLER SHAFT
24	REC90201-22429	90201-22429	ARANDELA	WASHER
	PAT40-04060005-2	63D-45577-10	GRUESO 0.12 mm	SHIM 0.12 mm
25	PAT40-04060005-3	63D-45577-20	GRUESO 0.15 mm	SHIM 0.15 mm
	PAT40-04060005-4	63D-45577-30	GRUESO 0.18 mm	SHIM 0.18 mm
	PAT40-04060005-5	63D-45577-40	GRUESO 0.30 mm	SHIM 0.30 mm
26	REC93306-001U1	93306-001U1	COJINETE	BEARING
27	REC93210-69MG6	93210-69MG6	TÓRICA	O-RING
28	REC93210-74MG5	93210-74MG5	TÓRICA	O-RING
29	REC63D-45361-02-4D	63D-45361-02-4D	DIÁBOLO	CAP, LOWER CASING
30	REC93317-22204	93317-22204	COJINETE	BEARING
31	REC93101-22M00	93101-22M00	RETÉN DE ACEITE	OIL SEAL
32	PAF60-04030000	63D-45361-02-8D	FUNDA INFERIOR COMPLETA	COVER ASSY, LOWER CASING
33	REC663-45987-00	663-45987-02	ESPACIADOR	SPACER
34	REC66T-45997-00	667-45997-00	ESPACIADOR	SPACER
35	REC90389-22M01	90389-22M01	CASQUILLO HELICE	WASHER
36	REC90171-16011	90171-16011	TUERCA	LOCK NUT
37	REC91490-30025	91490-30025	PASADOR	PIN
38	REC67C-45251-00AL	67C-45251-00	ÁNODO	ÁNODO
39	REC67C-45371-00AL	67C-45371-00	ÁNODO	ÁNODO

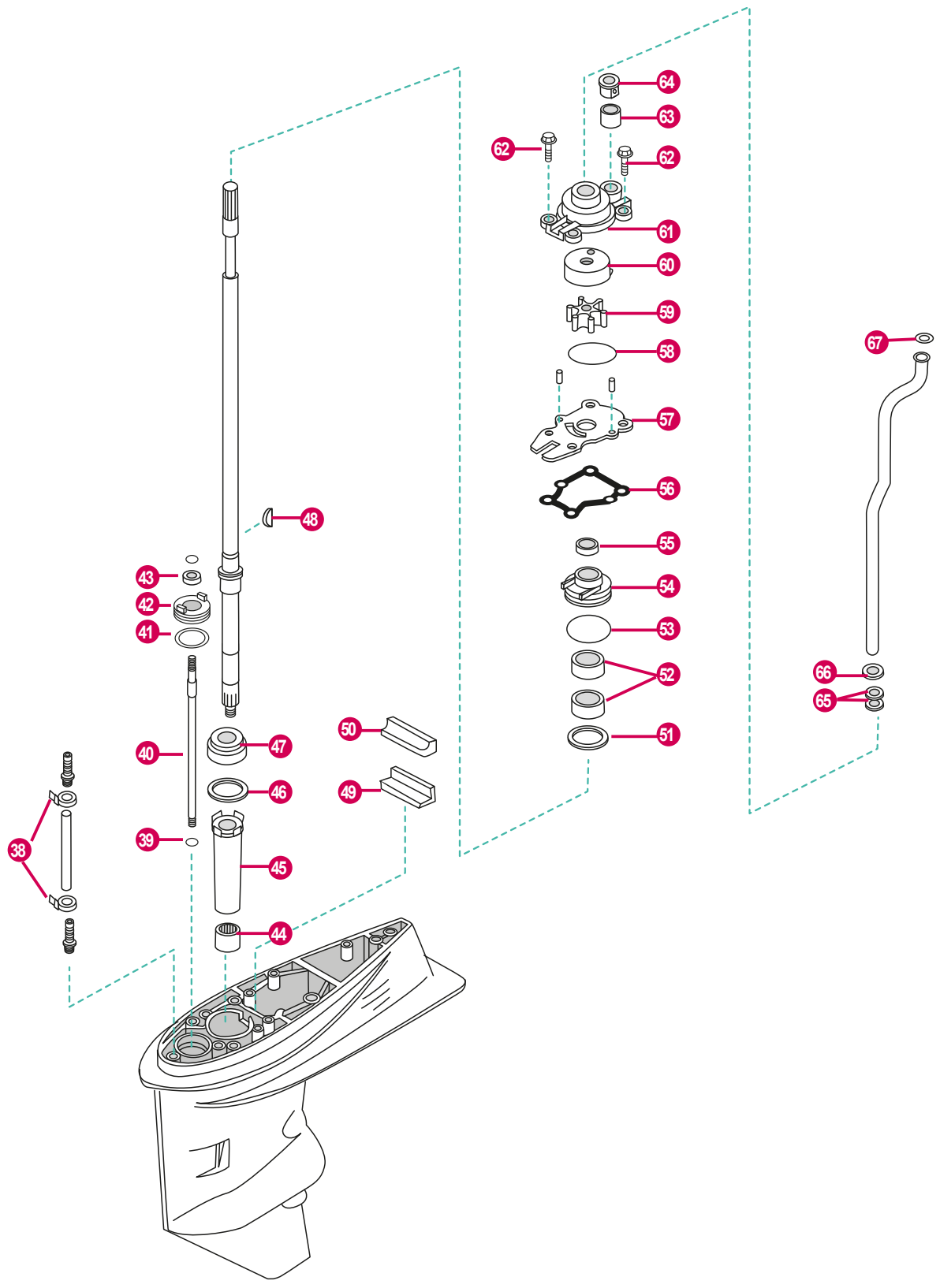

	REF	OEM		
38	PAHT-2.5X60	90465-11M10	BRIDA	CLAMP
39	REC99001-08600-00	99001-08600	ARANDELA	WASHER
40	PA60-04000004	63D-44144-00	VARILLA DE CAMBIO	SHIFTING CAM
41	REC93210-33MG4	93210-33MG4	TÓRICA	O-RING
42	PAF60-04000101	63D-45321-00	PLACA	COVER, SHIFTING CAM
43	REC93106-09014	93106-09014	RETÉN DE ACEITE	OIL SEAL
44	REC93315-32224	93315-32224	COJINETE	BEARING
45	PAT40-04000002	6H4-45536-00	CAMISA EJE	SLEEVE, DRIVE
	PAT40-04000003-1	663-45587-01	GRUESO 0.10 mm	SHIM 0.10 mm
46	PAT40-04000003-2	663-45587-10	GRUESO 0.12 mm	SHIM 0.12 mm
	PAT40-04000003-3	663-45587-20	GRUESO 0.15 mm	SHIM 0.15 mm
	PAT40-04000003-5	663-45587-40	GRUESO 0.30 mm	SHIM 0.30 mm
47	REC93332-00001	93332-00001	COJINETE	BEARING
48	REC90280-03024	90280-03024	CUÑA	KEY WOODRUFF
49	REC663-45376-00	663-45376-00-94	GUÍA SELLO DE GOMA	GUIDE RUB SEAL
50	PAT40-04000014	63D-45375-00	SELLO DE GOMA	WATER ENVELOP
51	PAT40-04000008	90201-27M00	ARANDELA	WASHER
52	REC93101-25M57	93101-25M57	RETÉN DE ACEITE	OIL SEAL
53	REC93210-48MG8	93210-48MG8	TÓRICA	O-RING
54	REC63D-44341-00	63D-44341-00	CAJA DE BOMBA	HOUSING PUMP
55	PAT40-04000009	66T-45344-01	CUBIERTA SELLO DE ACEITE	COVER SEAL OIL
56	REC63D-44316-00	63D-44316-00	JUNTA	GASKET
57	REC63D-44323-00	63D-44323-00	PLACA EXTERIOR	OUTER PLATE
58	REC93210-59MG7	93210-59MG7	TÓRICA	O-RING
59	REC6H4-44352-02	6H4-44352-00	TURBINA	IMPELLER
60	REC63D-44322-00	63D-44322-00	TAPA, BOMBA AGUA	COVER, INNER WATER PUMP
61	PAF60-04000401	63D-44311-00	CUERPO BOMBA AGUA	HOUSING, WATER PUMP
62	REC90119-08M15	90119-08M15	TORNILLO CON ARANDELA	SCREW WITH WASHER
63	REC663-44366-00	663-44366-00	GOMA DEL SELLO DE AGUA	GUIDE BUSHING, WATER PIPE
64	REC63D-44312-00	63D-44312-00	CUBIERTA CAJA DE BOMBA DE AGUA	PUMP COVER
65	PAT40-02000002	663-44367-00	GOMA DEL SELLO DE AGUA	GUIDE BUSHING, WATER PIPE
66	REC90430-12072	90430-12072	JUNTA	GASKET
67	PAF25-02000019	90202-12060	ARANDELA PLANA	WASHER

4T
STROKES

F40D/H • F50F/H • F60C/T/B/F/A

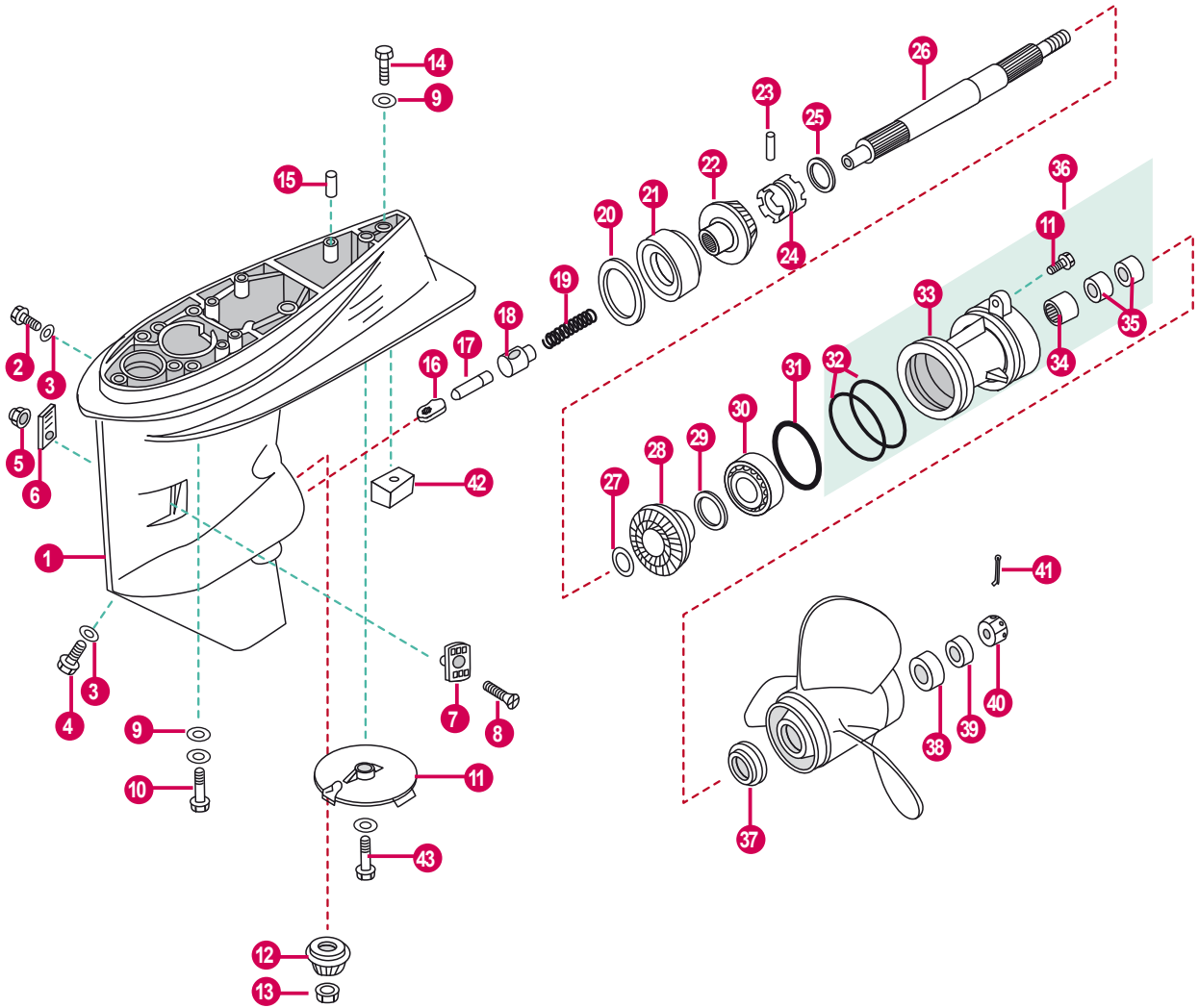

REF	OEM
REC63D-W0078-01	63D-W0078-01

	REF	OEM		
	PAF60-04000000	69W-45300-04-8D	COLA COMPLETA L	COMPLETE GEAR HOUSING L
1	PAF60-04000001	69W-45301-00-8D	CARCASA COMPLETA	LOWER CASING
2	REC90340-08002	90340-08002	TORNILLO DRENAJE	BOLT, DISCHARGING OIL
3	REC90430-08020	90430-08003	JUNTA	GASKET
4	REC688-45341-00	688-45341-10	TORNILLO DRENAJE	BOLT, DISCHARGING OIL
5	PAGB/T889.1-M5	95380-05600	TUERCA	LOCK NUT
6	PAT40-04000023	63D-45215-00	CUBIERTA ENTRADA AGUA B	WATER INLET B
7	PAT40-04000022	63D-45214-00	CUBIERTA ENTRADA AGUA A	WATER INLET A
8	PAGB/T820-M5X30	90152-05010	TORNILLO	SCREW
9	PAGB/T97.1-8	92995-10600	ARANDELA	WASHER
10	REC97075-10040	97075-10040	PERNO	STUD
11	PAGB/T5783-M8X25	97095-08025	PERNO	STUD
12	PAF60-04000002	69W-45551-00	PIÑÓN ATAQUE	INITIATIVE GEAR
13	REC90170-12138	90170-12138	TUERCA	LOCK NUT
14	PAGB/T5783-M8X35	97095-08035	PERNO	STUD
15	REC93606-12019	93606-12019	PASADOR	PIN
16	PAF60-04000003	62Y-44151-00	LEVA DE CAMBIO	SHIFTING CAM
17	PAF60-04020005	63D-45635-00	ÉMBOLO	PLUNGER
18	REC663-45634-00	663-45634-00	DESGLIZADOR DEL CAMBIO	CLUTCH DOG
19	PAF60-04020002	90501-18001	MUELLE	SPRING
20	PAT40-04000004-1	663-45567-01	GRUESO 0.10 mm	SHIM 0.10 mm
	PAT40-04000004-5	663-45567-40	GRUESO 0.30 mm	SHIM 0.30 mm
21	PAKOYOHI-CAP322/32	93332-00092	COJINETE	BEARING
22	PAF60-04000600	69W-45560-00	PIÑÓN MARCHA AVANTE	POSITIVE GEAR ASSY
23	REC90250-06023	90250-06023	PASADOR	PIN
24	PAF60-04020003	62Y-45631-00	EMBRAGUE DE GARRA	CLUTCH DOG
25	PAT40-04050005	67C-45633-00	ANILLO DEL PASADOR	ANNULAR SPRING, CLUTCH
26	PAF60-04020001	63D-45611-00	EJE HÉLICE	PROPELLER SHAFT
27	PAT40-04050007	90201-22008	ARANDELA	WASHER
28	PAF60-04000500	62Y-45571-00	PIÑÓN MARCHA ATRÁS	REVERSE GEAR
	PAT40-04060005-2	63D-45577-10	GRUESO 0.12 mm	SHIM 0.12 mm
29	PAT40-04060005-3	63D-45577-20	GRUESO 0.15 mm	SHIM 0.15 mm
	PAT40-04060005-4	63D-45577-30	GRUESO 0.18 mm	SHIM 0.18 mm
	PAT40-04060005-5	63D-45577-40	GRUESO 0.30 mm	SHIM 0.30 mm
30	REC93306-001U1	93306-001U1	COJINETE	BEARING
31	REC93210-69MG6	93210-69MG6	TÓRICA	O-RING
32	REC93210-74MG5	93210-74MG5	TÓRICA	O-RING
33	REC63D-45361-02-4D	63D-45361-02-8D	DIÁBOLO	CAP, LOWER CASING
34	REC93317-22204	93317-22204	COJINETE	BEARING
35	REC93101-22M00	93101-22M00	RETÉN DE ACEITE	OIL SEAL
36	PAF60-04030000	63D-45361-02-8D	FUNDA INFERIOR COMPLETA	COVER ASSY, LOWER CASING
37	REC663-45987-00	663-45987-02	ESPACIADOR	SPACER
38	REC66T-45997-00	667-45997-00	ESPACIADOR	SPACER
39	REC90389-22M01	90389-22M01	CASQUILLO HÉLICE	WASHER
40	REC90171-16011	90171-16011	TUERCA	LOCK NUT
41	REC91490-30025	91490-30025	PASADOR	PIN
42	REC67C-45251-00AL	67C-45251-00	ÁNODO	ÁNODO
43	REC67C-45371-00AL	67C-45371-00	ÁNODO	ÁNODO

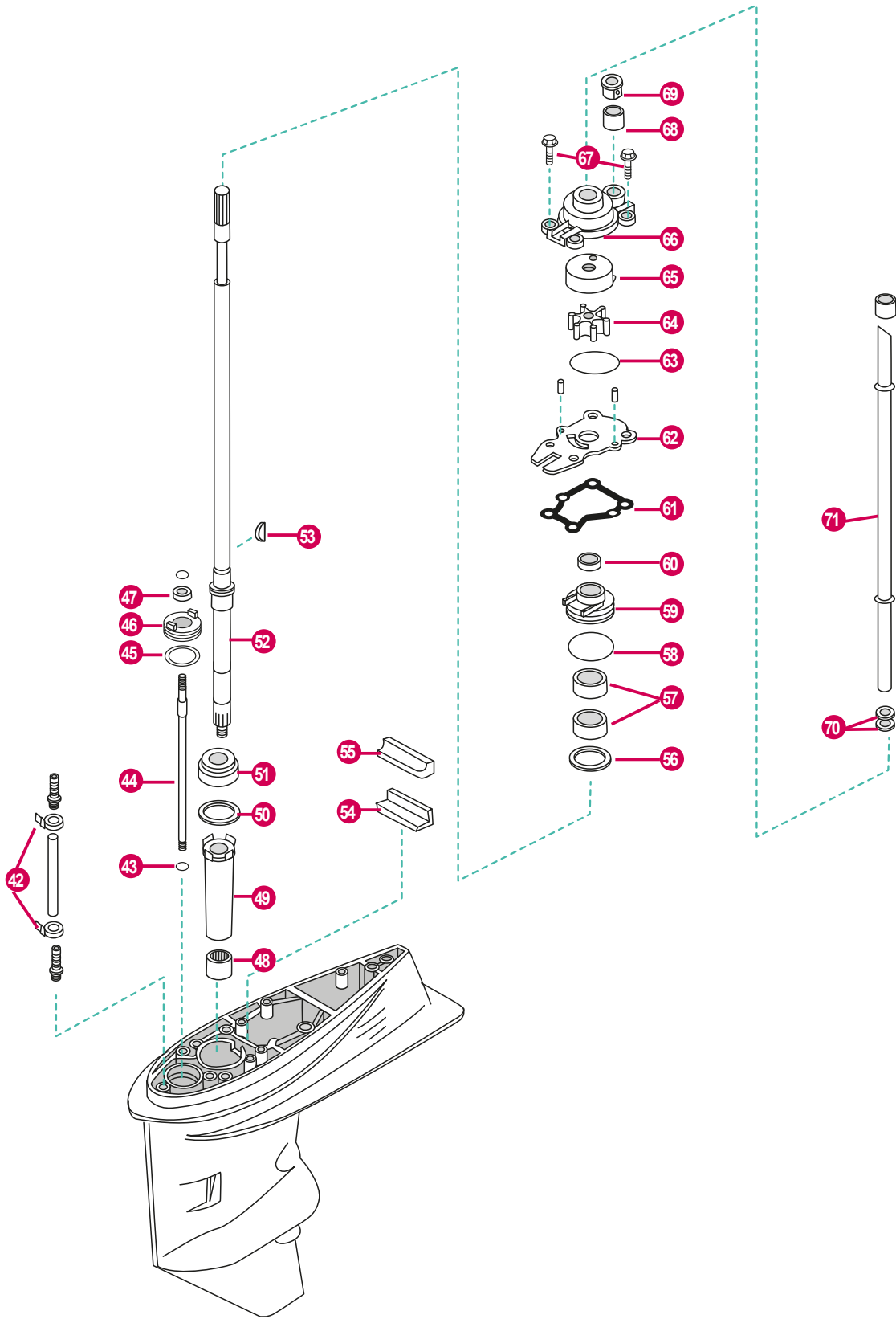

	REF	OEM		
42	PAHT-2.5X60	90465-11M10	BRIDA	CLAMP
43	REC99001-08600-00	99001-08600	ARANDELA	WASHER
44	PA60-04000004	63D-44144-00	VARILLA DE CAMBIO	SHIFTING CAM
45	REC93210-33MG4	93210-33MG4	TÓRICA	O-RING
46	PAF60-04000101	63D-45321-00	PLACA	COVER, SHIFTING CAM
47	REC93106-09014	93106-09014	RETÉN DE ACEITE	OIL SEAL
48	REC93315-32224	93315-32224	COJINETE	BEARING
49	PAT40-04000002	6H4-45536-00	CAMISA EJE	SLEEVE, DRIVE
	PAT40-04000003-1	663-45587-01	GRUESO 0.10 mm	SHIM 0.10 mm
	PAT40-04000003-2	663-45587-10	GRUESO 0.12 mm	SHIM 0.12 mm
50	PAT40-04000003-3	663-45587-20	GRUESO 0.15 mm	SHIM 0.15 mm
	PAT40-04000003-5	663-45587-40	GRUESO 0.30 mm	SHIM 0.30 mm
51	REC93332-00001	93332-00001	COJINETE	BEARING
52	PAF60-04010000	69W-45501-00	EJE VERTICAL COMPLETO	DRIVE SHAFT
53	REC90280-03024	90280-03024	CUÑA	KEY WOODRUFF
54	REC663-45376-00	663-45376-00-94	GUÍA SELLO DE GOMA	GUIDE RUB. SEAL
55	PAT40-04000014	63D-45375-00	SELLO DE GOMA	WATER ENVELOP
56	PAT40-04000008	90201-27M00	ARANDELA	WASHER
57	REC93101-25M57	93101-25M57	RETÉN DE ACEITE	OIL SEAL
58	PAJASOF40424-050	93210-48001	TÓRICA	O-RING
59	PAT40-04040001	6BG-44341-00	CAJA DE BOMBA	CASING A, OIL SEAL
60	PAF60-04000008	63D-45344-00	CUBIERTA SELLO DE ACEITE	COVER, OIL SEAL
61	REC63D-44316-00	63D-44316-00	JUNTA	GASKET
62	REC63D-44323-00	63D-44323-00	PLACA EXTERIOR	WATER PLATE
63	REC93210-59MG7	93210-59MG7	TÓRICA	O-RING
64	REC6H3-44352-00	6H3-44352-00	TURBINA	IMPELLER
65	REC63D-44322-00	63D-44322-00	TAPA, BOMBA AGUA	COVER, INNER WATER PUMP
66	PAF60-04000401	63D-44311-00	CUERPO BOMBA AGUA	HOUSING, WATER PUMP
67	REC90119-08M15	90119-08M15	TORNILLO CON ARANDELA	SCREW WITH WASHER
68	REC663-44366-00	663-44366-00	GOMA DEL SELLO DE AGUA	GUIDE BUSHING, WATER PIPE
69	REC63D-44312-00	63D-44312-00	CUBIERTA CAJA DE BOMBA DE AGUA	PUMP COVER
70	PAT40-02000002	663-44367-00	GOMA DEL SELLO DE AGUA	GUIDE BUSHING, WATER PIPE
71	PAF60-02000007	6C5-44361-00	TUBO DE AGUA	WATER TUBE

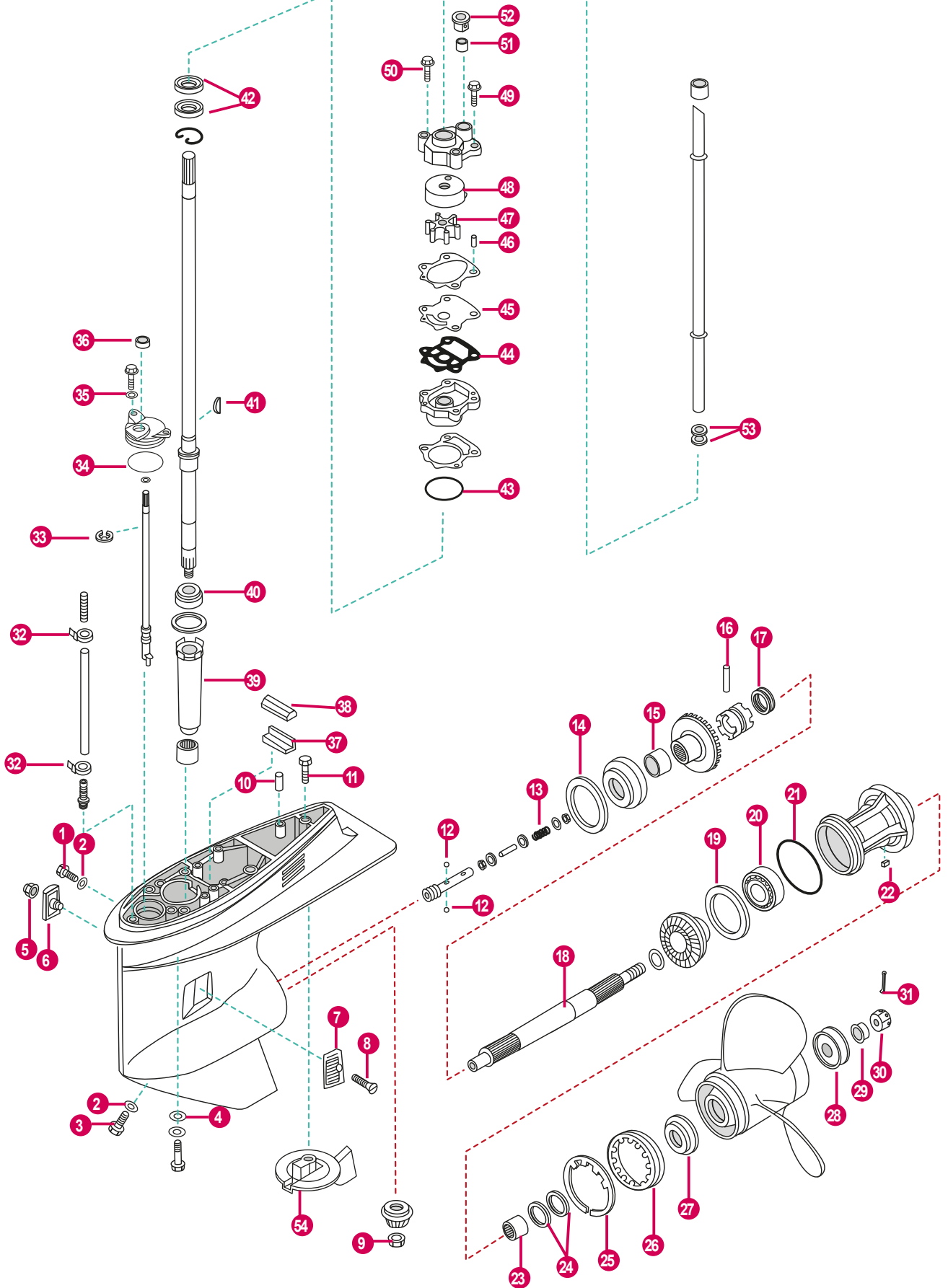

	REF	OEM		
1	REC90340-08002	90340-08002	TORNILLO DRENAJE	BOLT, DISCHARGING OIL
2	REC90430-08020	90430-08003	JUNTA	GASKET
3	REC688-45341-00	688-45341-10	TORNILLO DRENAJE	BOLT, DISCHARGING OIL
4	PAGB/T97.1-8	92995-10600	ARANDELA	WASHER
5	PAGB/T6182-M5	90185-05002	TUERCA	LOCK NUT
6	REC6H1-45215-00	6H1-45215-00	CUBIERTA ENTRADA AGUA B	WATER INLET B
7	REC6H1-45214-00	6H1-45214-00	CUBIERTA ENTRADA AGUA A	WATER INLET A
8	REC90151-05M00	90152-05000	TORNILLO	SCREW
9	REC90170-16M01	90170-16M01	TUERCA	LOCK NUT
10	REC93606-12019	93606-12019	PASADOR	PIN
11	PAT85-00000012	90105-16M67	PERNO	STUD
12	REC93503-16003	93503-16003	ESFERA	BALL
13	REC90501-12M48	90501-12M48	MUELLE	SPRING
14	PAT85-040000004-B	688-45567-01	GRUESO 0.10 mm	SHIM 0.10 mm
15	REC93317-322V0	93317-322V0	COJINETE	BEARING
16	REC90250-07M02	90250-07M02	PASADOR	PIN
17	REC688-45633-00	688-45633-00	ANILLO DEL PASADOR	ANNULAR SPRING, CLUTCH
18	REC67F-45611-01	67F-45611-01	EJE HÉLICE	PROPELLER SHAFT
19	REC67F-45576-00	67F-45576-00	ARANDELA	WASHER
20	REC93306-207U0	93306-207U0	COJINETE	BEARING
21	REC93210-86M39	93210-86M39	TÓRICA	O-RING
22	REC90282-04010	90282-04010	CHAVETA RECTA	KEY
23	REC93317-325U0	93317-325U0	COJINETE	BEARING
24	REC93101-25M03	93101-25M03	RETÉN DE ACEITE	OIL SEAL
25	REC688-45383-01	688-45383-02	ARANDELA	WASHER
26	REC688-45384-00	688-45384-02	TUERCA	NUT
27	REC688-45987-00	688-45987-01	ESPACIADOR	SPACER
28	REC67F-45997-00	67F-45997-00	ESPACIADOR	SPACER
29	REC90389-25M00	90389-25M00	CASQUILLO HÉLICE	WASHER
30	REC90171-16011	90171-16011	TUERCA	LOCK NUT
31	REC91490-30025	91490-30025	PASADOR	PIN
32	PAHT-2.5X60	90465-11M10	BRIDA	CLAMP
33	REC99001-08600-00	99001-08600	ARANDELA	WASHER
34	REC93210-49046	93210-49046	TÓRICA	O-RING
35	PAGB/T96-6	92995-06600	ARANDELA	WASHER
36	REC93106-09014	93106-09014	RETÉN DE ACEITE	OIL SEAL
37	REC663-45376-00	663-45376-00-94	GUÍA SELLO DE GOMA	GUIDE RUB. SEAL
38	REC688-45375-00	63D-45375-00	RETEN DAMPER	DAMPER WASHER
39	REC688-45536-01	688-45536-01	CAMISA EJE	SLEEVE, DRIVE
40	REC93332-000U3	93332-000U3	COJINETE	BEARING
41	REC90280-03M03	90280-03M03	CUÑA	KEY WOODRUFF
42	REC93101-23070	93101-23070	RETÉN DE ACEITE	OIL SEAL
43	REC93210-46044	93210-46044	TÓRICA	O-RING
44	REC6CJ-44324-00	6CJ-44324-00	JUNTA	GASKET
45	REC6CJ-44323-00	6CJ-44323-00	PLACA EXTERIOR	OUTER PLATE, CARTRIDGE
46	PAF15-00000013	93604-10M03	PASADOR	PIN
47	REC6H3-44352-00	6H3-44352-00	TURBINA	IMPELLER
48	REC63D-44322-00	63D-44322-00	TAPA, BOMBA AGUA	COVER, INNER WATER PUMP
49	REC90119-08M14	90119-08M14	TORNILLO CON ARANDELA	SCREW WITH WASHER
50	REC90119-08M33	90119-08M33	TORNILLO CON ARANDELA	SCREW WITH WASHER
51	REC663-44366-00	663-44366-00	GOMA DEL SELLO DE AGUA	DAMPER, WATER SEAL
52	REC63D-44312-00	63D-44312-00	CUBIERTA CAJA DE BOMBA DE AGUA	PUMP COVER
53	PAT40-02000002	663-44367-00	GOMA DEL SELLO DE AGUA	GUIDE BUSHING, WATER PIPE
54	REC67F-45371-00AL	67F-45371-00	ÁNODO	ÁNODE



REF	OEM
REC6CJ-W0078-00	6CJ-W0078-00

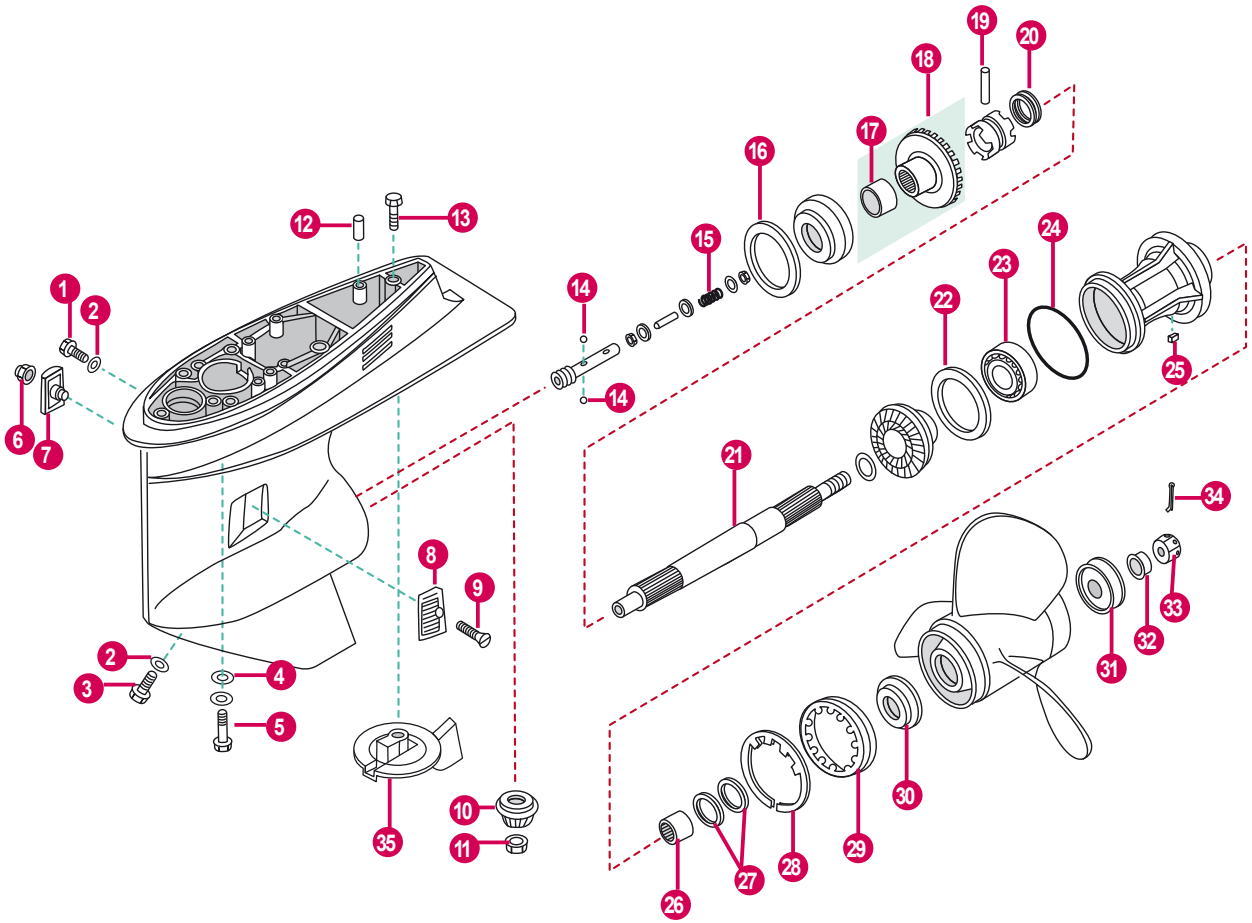

REF	OEM
REC67F-W0078-00	67F-W0078-00

	REF	OEM		
1	REC90340-08002	90340-08002	TORNILLO DRENAJE	BOLT, DISCHARGING OIL
2	REC90430-08020	90430-08003	JUNTA	GASKET
3	REC688-45341-00	688-45341-10	TORNILLO DRENAJE	BOLT, DISCHARGING OIL
4	PAGB/T97.1-8	92995-10600	ARANDELA	WASHER
5	REC97075-10040	97075-10040	PERNO	STUD
6	PAGB/T6182-M5	90185-05002	TUERCA	LOCK NUT
7	REC6H1-45215-00	6H1-45215-00	CUBIERTA ENTRADA AGUA B	WATER INLET B
8	REC6H1-45214-00	6H1-45214-00	CUBIERTA ENTRADA AGUA A	WATER INLET A
9	REC90151-05M00	90152-05000	TORNILLO	SCREW
10	REC6D9-45551-00	6D9-45551-00	PIÑÓN ATAQUE	INITIATIVE GEAR
11	REC90170-16M01	90170-16M01	TUERCA	LOCK NUT
12	REC93606-12019	93606-12019	PASADOR	PIN
13	PAT85-00000012	90105-16M67	PERNO	STUD
14	REC93503-16003	93503-16003	ESFERA	BALL
15	REC90501-12M48	90501-12M48	MUELLE	SPRING
16	PAT85-040000004-B	688-45567-01	GRUESO 0.10 mm	SHIM 0.10 mm
17	REC93317-322V0	93317-322V0	COJINETE	BEARING
18	REC67F-45560-00	67F-45560-00	PIÑÓN MARCHA AVANTE	POSITIVE GEAR ASSY
19	REC90250-07M02	90250-07M02	PASADOR	PIN
20	REC688-45633-00	688-45633-00	ANILLO DEL PASADOR	ANNULAR SPRING, CLUTCH
21	REC67F-45611-01	67F-45611-01	EJE HÉLICE	PROPELLER SHAFT
22	REC67F-45576-00	67F-45576-00	ARANDELA	WASHER
23	REC93306-207U0	93306-207U0	COJINETE	BEARING
24	REC93210-86M39	93210-86M39	TÓRICA	O-RING
25	REC90282-04010	90282-04010	CHAVETA RECTA	KEY
26	REC93317-325U0	93317-325U0	COJINETE	BEARING
27	REC93101-25M03	93101-25M03	RETÉN DE ACEITE	OIL SEAL
28	REC688-45383-01	688-45383-02	ARANDELA	WASHER
29	REC688-45384-00	688-45384-02	TUERCA	NUT
30	REC688-45987-00	688-45987-01	ESPACIADOR	SPACER
31	REC67F-45997-00	67F-45997-00	ESPACIADOR	SPACER
32	REC90389-25M00	90389-25M00	CASQUILLO HÉLICE	WASHER
33	REC90171-16011	90171-16011	TUERCA	LOCK NUT
34	REC91490-30025	91490-40025	PASADOR	PIN
35	REC67F-45371-00AL	67F-45371-00	ÁNODO	ÁNODO

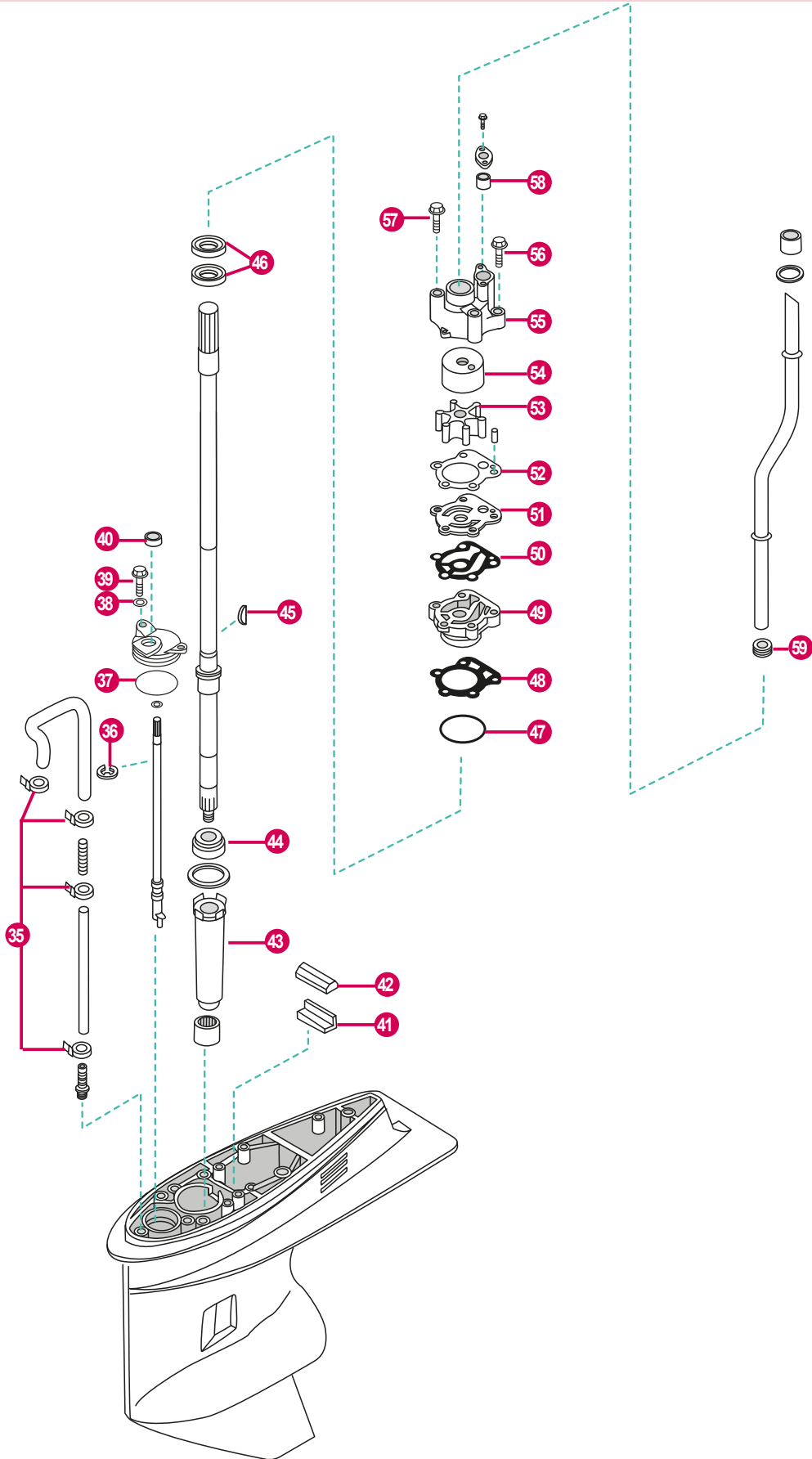

	REF	OEM		
35	PAHT-2.5X60	90465-11M10	BRIDA	CLAMP
36	REC99001-08600-00	99001-08600	ARANDELA	WASHER
37	REC93210-49046	93210-49046	TÓRICA	O-RING
38	PAGB/T96-6	92995-06600	ARANDELA	WASHER
39	PAGB/T5783-M6X16	97095-06016	PERNO HEXAGONAL	HEXAGON BOLT
40	REC93106-09014	93106-09014	RETÉN DE ACEITE	OIL SEAL
41	REC663-45376-00	663-45376-00-94	GUÍA SELLO DE GOMA	GUIDE RUB. SEAL
42	REC688-45375-00	63D-45375-00	RETEN DAMPER	DAMPER WASHER
43	REC688-45536-01	688-45536-01	CAMISA EJE	SLEEVE, DRIVE
44	REC93332-000U3	93332-000U3	COJINETE	BEARING
45	REC90280-04M04	90280-04M04	CUÑA	KEY WOODRUFF
46	REC93101-25M03	93101-25M03	RETÉN DE ACEITE	OIL SEAL
47	REC93210-46044	93210-46044	TÓRICA	O-RING
48	REC688-44316-00	688-44316-00	JUNTA	GASKET
49	REC688-44341-01	6D8-44341-01	CUERPO RETENES BOMBA DE AGUA	HOUSING WATER PUMP
50	REC688-44324-00	688-44324-A0	JUNTA	GASKET
51	REC67F-44323-00	67F-44323-00	PLACA EXTERIOR	WEAR PLATE
52	REC688-44315-00	688-44315-A0	JUNTA	GASKET
53	REC67F-44352-00	67F-44352-00	TURBINA	IMPELLER
54	REC67F-44322-00	67F-44322-00	TAPA, BOMBA AGUA	COVER, INNER WATER PUMP
55	REC67F-44311-01	67F-44311-00	CUERPO BOMBA AGUA	HOUSING, WATER PUMP
56	REC90119-08M13	90119-08M13	TORNILLO CON ARANDELA	SCREW WITH WASHER
57	REC90119-08M87	90119-08M87	TORNILLO CON ARANDELA	SCREW WITH WASHER
58	REC663-44366-00	663-44366-00	RETEN TUBO AGUA	DAMPER, WATER SEAL
59	PAT40-02000002	663-44367-00	GOMA DEL SELLO DE AGUA	GUIDE BUSHING, WATER PIPE

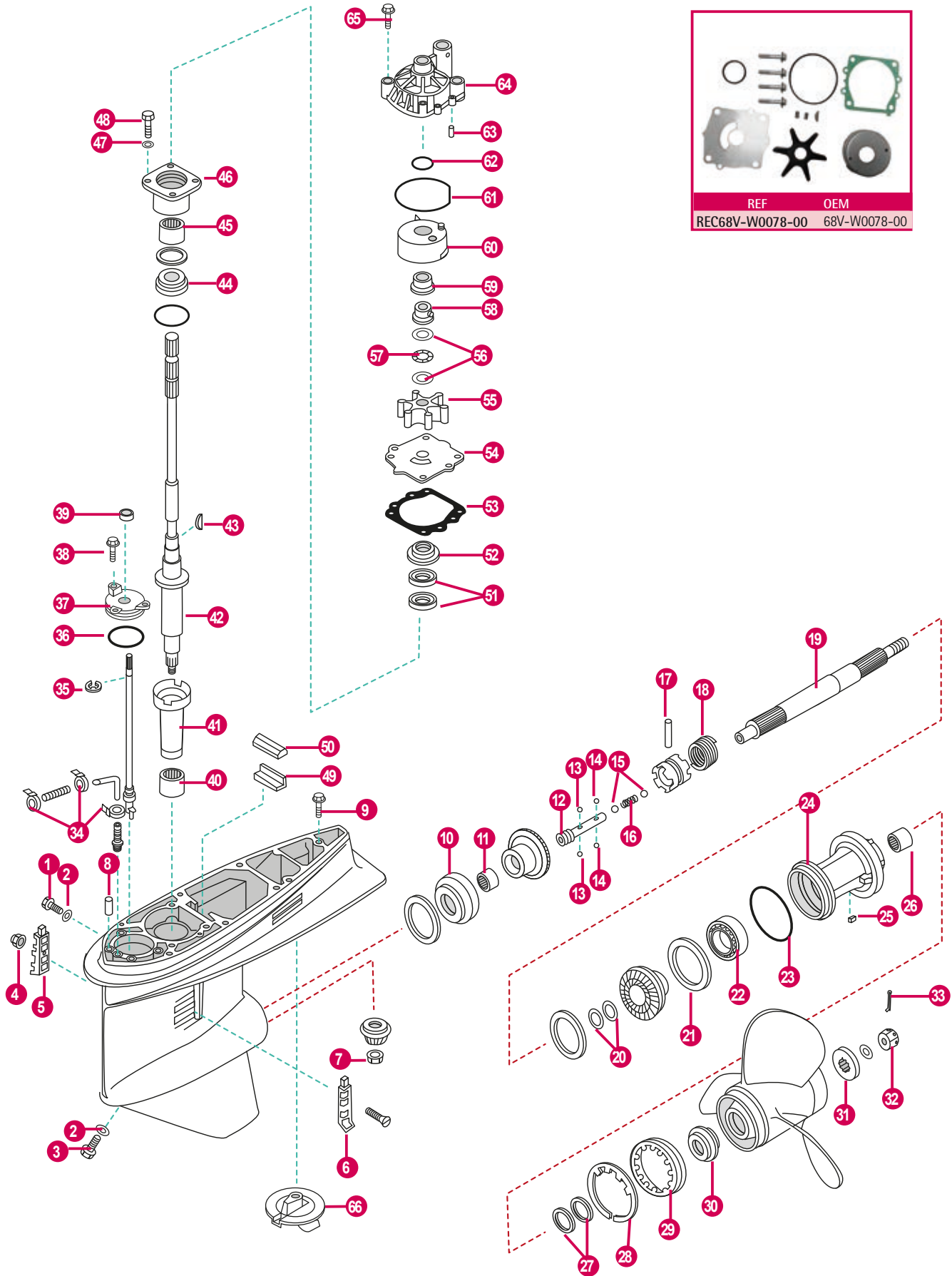

	REF	OEM		
1	REC90340-08002	90340-08002	TORNILLO DRENAJE	BOLT, DISCHARGING OIL
2	REC90430-08020	90430-08003	JUNTA	GASKET
3	REC688-45341-00	688-45341-10	TORNILLO DRENAJE	BOLT, DISCHARGING OIL
4	PAGB/T6182-M5	90185-05002	TUERCA	LOCK NUT
5	REC688-45215-02	688-45215-02	CUBIERTA ENTRADA AGUA B	WATER INLET B
6	REC688-45214-02	688-45214-02	CUBIERTA ENTRADA AGUA A	WATER INLET A
7	REC90170-16M01	90170-16M01	TUERCA	LOCK NUT
8	REC93608-12M05	93608-12M05	PASADOR	PIN
9	PAT85-00000012	90105-10M00	TORNILLO	SCREW
10	REC93332-000U7	93332-000U7	COJINETE	BEARING
11	REC93315-425U7	93315-425U7	COJINETE	BEARING
12	REC6E5-45634-01	6E5-45634-01	PASADOR DESPLAZABLE	SLIDE SHIFT
13	REC93507-32031	93507-32009	ESFERA	BALL
14	REC93503-16003	93503-16003	ESFERA	BALL
15	REC93511-32027	93511-32027	ESFERA	BALL
16	REC90501-16M37	90501-16M37	MUELLE	SPRING
17	REC90250-08M07	90250-08M07	PASADOR	PIN
18	REC6E5-45633-01	6E5-45633-01	ANILLO DEL PASADOR	ANNULAR SPRING, CLUTCH
19	REC6E5-45611-00	6E5-45611-00	EJE HÉLICE	PROPELLER SHAFT
20	REC90201-30M92	90201-30M92	ARANDELA	WASHER
21	REC6E5-45576-00	6E5-45576-00	ARANDELA	WASHER
22	REC93306-208U0	93306-208U0	COJINETE	BEARING
23	REC93210-86M39	93210-86M39	TÓRICA	O-RING
24	REC6E5-45332-00-94	6E5-45332-00-CA	DIÁBOLO	GEAR HOUSING
25	REC90282-04010	90282-04010	CHAVETA RECTA	KEY
26	REC93315-43061	93315-430U8	COJINETE	BEARING
27	REC93101-30M17	93101-30M17	RETÉN DE ACEITE	OIL SEAL
28	REC688-45383-01	688-45383-02	ARANDELA	WASHER
29	REC688-45384-00	688-45384-02	TUERCA	NUT
30	REC6E5-45987-00	63P-45987-00	ESPACIADOR	SPACER
31	REC688-45997-00	688-45997-01	ESPACIADOR	SPACER
32	REC90171-18M04	90171-18M04	TUERCA	LOCK NUT
33	REC91490-30025	91490-40030	PASADOR	PIN
34	PAHT-2.5X60	90465-11M10	BRIDA	CLAMP
35	REC99001-08600-00	99001-08600	ARANDELA	WASHER
36	REC93210-58677	93210-58144	TÓRICA	O-RING
37	REC6E5-45321-00	6E5-45321-00	TAPA CAMBIO	PLATE
38	REC90119-06M10	90119-06M10	TORNILLO CON ARANDELA	SCREW WITH WASHER
39	REC93106-09014	93106-09014	RETÉN DE ACEITE	OIL SEAL
40	REC93315-628U9	93315-628U9	COJINETE	BEARING
41	REC6E5-45536-00	6E5-45536-00	CAMISA EJE DE MANDO	SLEEVE
42	REC68V-45501-10	68V-45501-10	EJE TRANSMISION L 20.3"	DRIVE SHAFT L 20.3"
43	REC90280-04M05	90280-04M05	CUÑA	KEY WOODRUFF
44	REC93341-930V2	93341-930V2	COJINETE	BEARING
45	REC93315-430V5	93317-330U2	COJINETE	BEARING

	REF	OEM		
46	REC6E5-45331-00-94	6E5-45331-00-95	DIÁBOLO	GEAR HOUSING
47	PAGB/T97.1-8	92995-08600	ARANDELA	WASHER
48	PAGB/T5783-M8X25	97095-08025	PERNO	BOLT
49	REC663-45376-00	663-45376-00	GUÍA SELLO DE GOMA	GUIDE RUB. SEAL
50	REC688-45375-00	63D-45375-00	RETEN DAMPER	DAMPER WASHER
51	REC93101-28M16	93101-28M16	RETÉN DE ACEITE	OIL SEAL
52	REC6E5-45344-00	6E5-45344-00	TAPA RETEN	RETAINER
53	REC6E5-44315-A0	6E5-44315-A0	JUNTA	GASKET
54	REC68V-44323-00	6EK-44323-00	TAPA BOMBA	OUTER PLATE
55	REC6E5-44352-01	6E5-44352-01	TURBINA	IMPELLER
56	REC90201-22M01	90201-22M01	ARANDELA	WASHER
57	REC90206-22M19	90206-22M19	ARANDELA ONDULADA	WAVE WASHER
58	REC61A-45538-00	61A-45538-00	ESPACIADOR	SPACER
59	REC61A-45527-00	61A-45527-00	CASQUILLO CUERPO BOMBA	COLLAR COVER, INNER
60	REC61A-44322-02	61A-44322-02	TAPA, BOMBA AGUA	WATER PUMP
61	REC93210-86M38	93210-86M38	TÓRICA	O-RING
62	REC93210-37M67	93210-37160	TÓRICA	O-RING
63	REC93606-12019	93606-12019	PASADOR	PIN
64	REC61A-44311-00	61A-44311-01	CUERPO BOMBA AGUA	HOUSING, WATER PUMP
65	REC90119-08M14	90119-08M14	TORNILLO CON ARANDELA	SCREW WITH WASHER
66	REC6E5-45371-01AL	6E5-45371-01	ÁNODO	ÁNODE

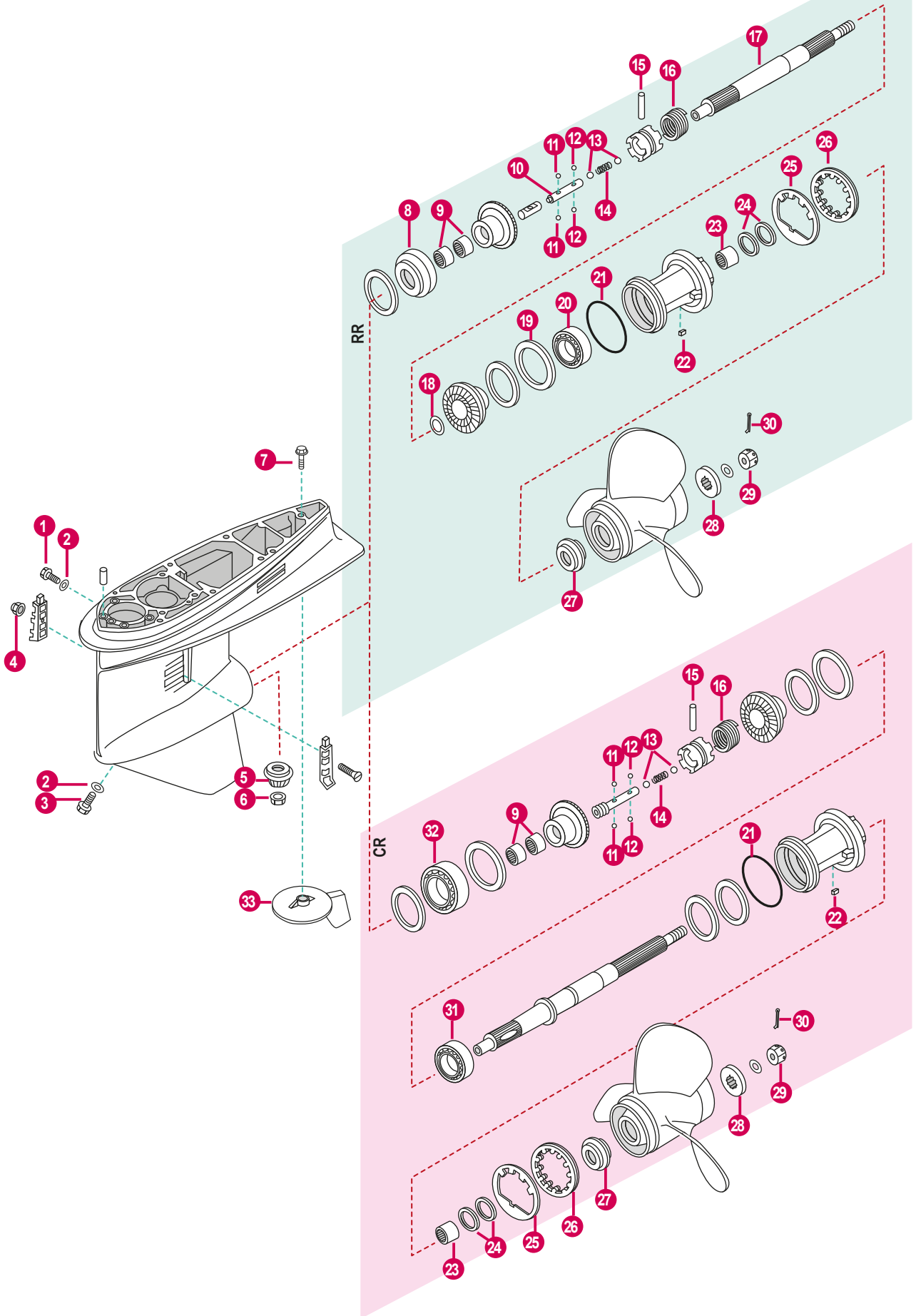

	REF	OEM		
1	REC90340-08002	90304-08002	TORNILLO DRENAJE	BOLT, DISCHARGING OIL
2	REC90430-08020	90430-08020	JUNTA	GASKET
3	REC688-45341-00	688-45341-10	TORNILLO DRENAJE	BOLT, DISCHARGING OIL
4	PAGB/T6182-M5	90185-05002	TUERCA	LOCK NUT
5	REC63P-45551-00	63P-45551-00	PIÑÓN ATAQUE	INITIATIVE GEAR
6	REC90170-16M01	90170-16M01	TUERCA	LOCK NUT
7	PAT85-00000012	90105-10M00	TORNILLO	SCREW
8	REC93332-000V3	93332-000V3	COJINETE	BEARING
9	REC93315-425V3	93315-425V3	COJINETE	BEARING
10	REC6E5-45634-01	6E5-45634-01	PASADOR DESPLAZABLE	SLIDE SHIFT
11	REC93507-32031	93507-32009	ESFERA	BALL
12	REC93503-16003	93503-16003	ESFERA	BALL
13	REC93511-32027	93511-32017	ESFERA	BALL
14	REC90501-16M37	90501-16M37	MUELLE	SPRING
15	REC90250-08M07	90250-08M07	PASADOR	PIN
16	REC6E5-45633-01	6E5-45633-01	ANILLO DEL PASADOR	ANNULAR SPRING, CLUTCH
17	REC6J9-45611-00	6J9-45611-01	EJE HÉLICE	PROPELLER SHAFT
18	REC90201-30M92	90201-30M92	ARANDELA	WASHER
19	REC6G5-45576-10	6G5-45576-10	ARANDELA EMPUJE	WASHER, THRUST
20	REC93306-209U0	93306-209U0	COJINETE	BEARING
21	REC93210-97M55	93210-97M55	TÓRICA	O-RING
22	REC90282-04M00	90282-04M00	CHAVETA RECTA	KEY
23	REC93315-43061	93315-43061	COJINETE	BEARING
24	REC93101-30M17	93101-30M17	RETÉN DE ACEITE	OIL SEAL
25	REC6G5-45383-01	6G5-45383-01	ARANDELA	WASHER
26	REC6G5-45384-00	6G5-45384-00	TUERCA	NUT
27	REC6E5-45987-00	63P-45987-00	ESPACIADOR	SPACER
28	REC688-45997-00	688-45997-01	ESPACIADOR	SPACER
29	REC90171-18M04	90171-18M04	TUERCA	LOCK NUT
30	REC91490-30025	91490-40030	PASADOR	PIN
33	REC6J9-45371-01AL	6J9-45371-01	ÁNODO	ÁNODO

			CONTRA ROTACIÓN	COUNTER ROTATION
31	REC93332-00048	93332-00048	COJINETE	BEARING
32	REC93332-000W7	93332-000U2	COJINETE MARCHA AVANTE	

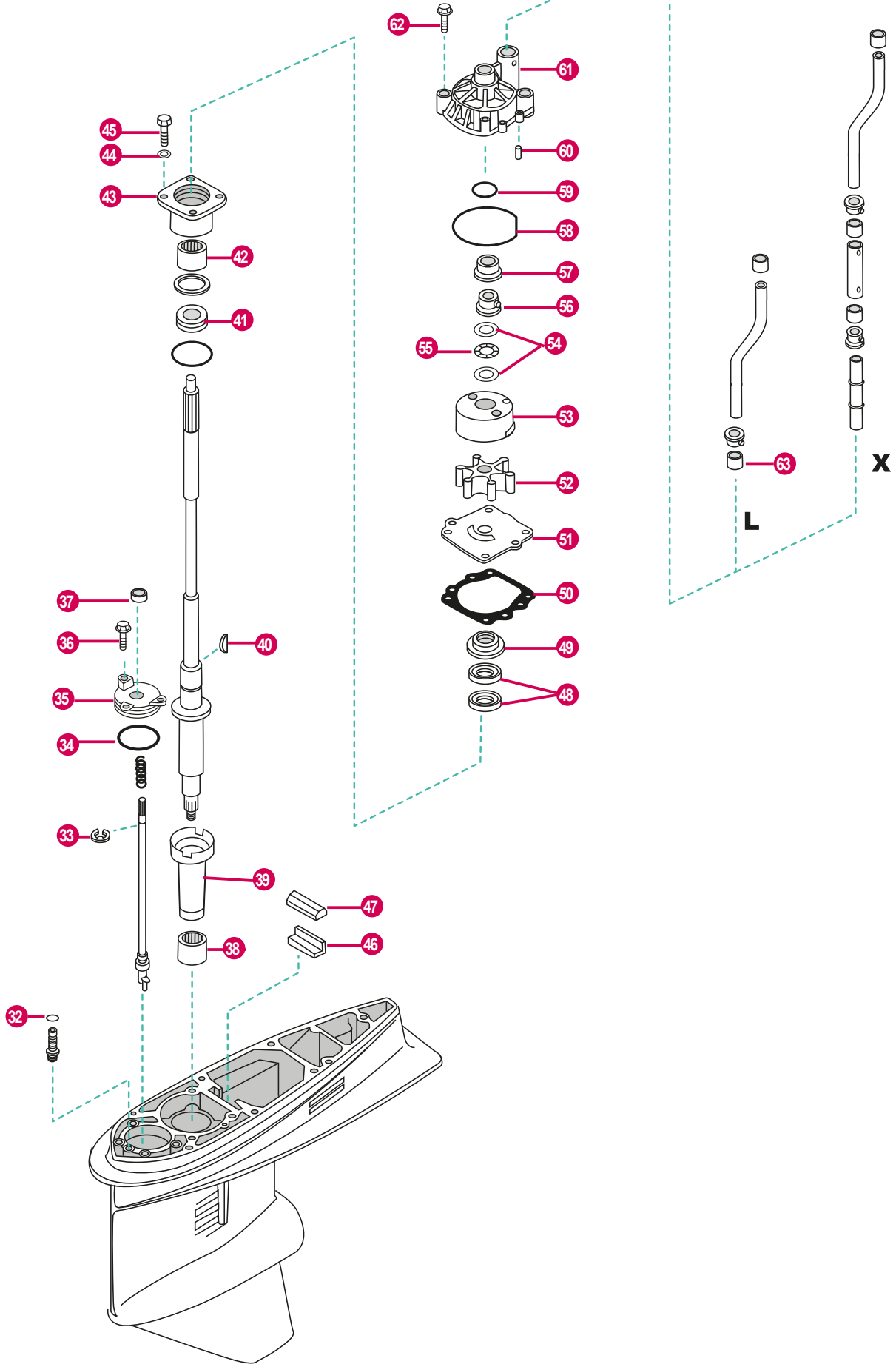

	REF	OEM		
32	REC93210-07540	93210-07003	TÓRICA	O-RING
33	REC99001-08600-00	99001-08600	CLIP	CLIP
34	REC93210-58677	93210-58144	TÓRICA	O-RING
35	REC6E5-45321-00	6E5-45321-00	TAPA CAMBIO	PLATE
36	REC90119-06M10	90119-06M10	TORNILLO CON ARANDELA	SCREW WITH WASHER
37	REC93106-09014	93106-09014	RETÉN DE ACEITE	OIL SEAL
38	REC93311-928U5	93311-928U5	COJINETE	BEARING
39	REC6E5-45536-00	6E5-45536-00	CAMISA EJE DE MANDO	SLEEVE
40	REC90280-04M05	90280-04M05	CUÑA	KEY WOODRUFF
41	REC93341-930V2	93341-930V2	COJINETE	BEARING
42	REC93315-430V5	93317-330U2	COJINETE	BEARING
43	REC6E5-45331-00-94	6E5-45331-00-95	DIÁBOLO	GEAR HOUSING
44	PAGB/T97.1-8	92995-08600	ARANDELA	WASHER
45	PAGB/T5783-M8X25	97095-08025	PERNO	BOLT
46	REC663-45376-00	663-45376-00-94	GUÍA SELLO DE GOMA	GUIDE RUB. SEAL
47	REC688-45375-00	688-45375-00	RETEN DAMPER	DAMPER WASHER
48	REC93101-28M16	93101-28M16	RETÉN DE ACEITE	OIL SEAL
49	REC6E5-45344-00	6E5-45344-00	CUBIERTA SELLO DE ACEITE	RETAINER
50	REC6E5-44315-A0	6E5-44315-A0	JUNTA	GASKET
51	REC6G5-44323-00	6G5-44323-00	PLACA EXTERIOR DEL CARTUCHO	OUTER PLATE
52	REC6E5-44352-01	6E5-44352-01	TURBINA	IMPELLER
53	REC61A-44322-02	61A-44322-02	ACOPLE INOX	INSERT CARTRIDGE
54	REC90201-22M01	90201-22M01	ARANDELA	WASHER
55	REC90206-22M19	90206-22M19	ARANDELA ONDULADA	WAVE WASHER
56	REC61A-45538-00	61A-45538-00	ESPACIADOR	SPACER
57	REC61A-45527-00	61A-45527-00	CASQUILLO CUERPO BOMBA	COLLAR
58	REC93210-86M38	93210-86M38	TÓRICA	O-RING
59	REC93210-37M67	93210-37160	TÓRICA	O-RING
60	REC93606-12019	93606-12019	PASADOR	PIN
61	REC61A-44311-00	61A-44311-01	CUERPO BOMBA AGUA	HOUSING, WATER PUMP
62	REC90119-08M14	90119-08M14	TORNILLO CON ARANDELA	SCREW WITH WASHER
63	REC6E5-44365-00	6E5-44365-00	GOMA DEL SELLO DE AGUA	DAMPER WATER TUBE



REF	OEM
REC61A-W0078-A1	61A-W0078-A1

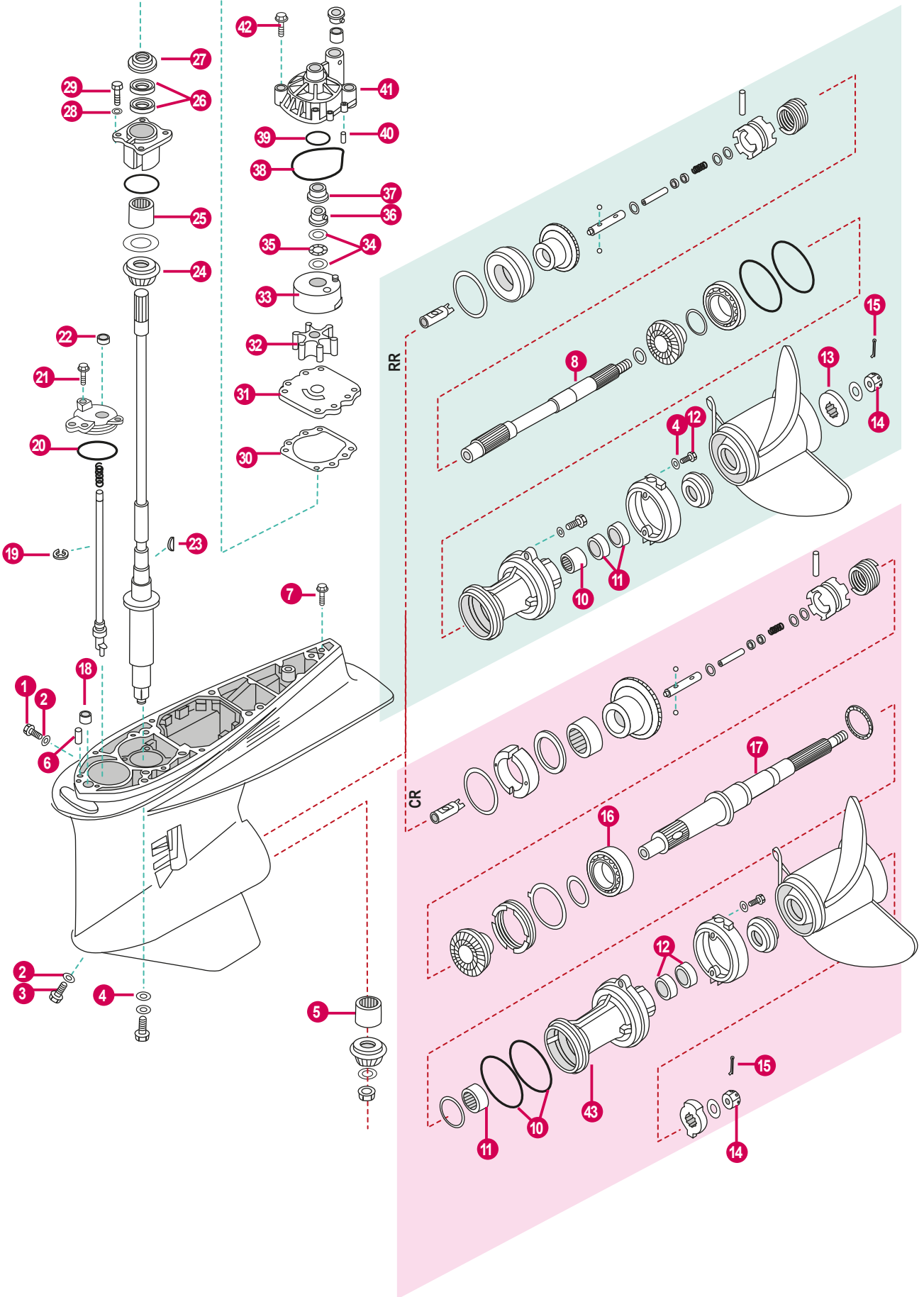

	REF	OEM		
1	REC90340-08002	90304-08002	TORNILLO DRENAJE	BOLT, DISCHARGING OIL
2	REC90430-08020	90430-08020	JUNTA	GASKET
3	REC688-45341-00	688-45341-10	TORNILLO DRENAJE	BOLT, DISCHARGING OIL
4	PAGB/T97.1-8	92995-10600	ARANDELA	WASHER
5	REC93311-83280	93311-83280	COJINETE	BEARING
6	REC93608-12M05	93608-12M05	PASADOR	PIN
7	PAT85-00000012	90105-10M00	TORNILLO	SCREW
8	REC69J-45611-00	69J-45611-00	EJE	SHAFT
10	REC93315-43061	93315-43061	COJINETE	BEARING
11	REC93101-30M17	93101-30M17	RETÉN DE ACEITE	OIL SEAL
12	PAF4-04000001	97095-08020	PERNO	STUD
13	REC688-45997-00	688-45997-01	ESPACIADOR AP	DISTANCE WASHER
14	REC90171-18M04	90171-18M04	TUERCA	LOCK NUT
15	REC91490-30025	91490-40030	PASADOR	PIN

			CONTRA ROTACIÓN	COUNTER ROTATION
16	REC93332-00048	93332-00048	COJINETE	BEARING
17	REC69K-45611-00	69K-45611-00	EJE	SHAFT
43	REC6D1-45332-00-CA	6D1-45332-00-CA	DIÁBOLO	DIABOLO

18	REC663-44366-00	663-44366-00	RETEN TUBO AGUA	DAMPER, WATER SEAL
19	REC99001-08600-00	99001-08600	CLIP	CLIP
20	REC93210-65752-00	93210-64488	TÓRICA	O-RING
21	REC90119-06M10	90119-06M10	TORNILLO CON ARANDELA	SCREW WITH WASHER
22	REC93106-09014	93106-09014	RETÉN DE ACEITE	OIL SEAL
23	REC90280-04M05	90280-04M05	CUÑA	KEY WOODRUFF
24	REC93341-93020	93341-93020	COJINETE	BEARING
25	REC93315-430V5	93317-330U2	COJINETE	BEARING
26	REC93101-28M16	93101-28M16	RETÉN DE ACEITE	OIL SEAL
27	REC6E5-45344-00	6E5-45344-00	CUBIERTA SELLO DE ACEITE	RETAINER
28	PAGB/T97.1-8	92995-08600	ARANDELA	WASHER
29	PAGB/T5783-M8X25	97095-08025	PERNO	STUD
30	REC6E5-44315-A0	6E5-44315-A0	JUNTA	GASKET
31	REC6G5-44323-00	6G5-44323-00	TAPA BOMBA	OUTER PLATE
32	REC6E5-44352-01	6E5-44352-01	TURBINA	IMPELLER
33	REC61A-44322-02	61A-44322-02	TAPA, BOMBA AGUA	COVER, INNER WATER PUMP
34	REC90201-22M01	90201-22M01	ARANDELA	WASHER
35	REC90206-22M19	90206-22M19	ARANDELA ONDULADA	WAVE WASHER
36	REC61A-45538-00	61A-45538-00	ESPACIADOR	SPACER
37	REC61A-45527-00	61A-45527-00	CASQUILLO CUERPO BOMBA	COLLAR
38	REC93210-86M38	93210-86M38	TÓRICA	O-RING
39	REC93210-37M67	93210-37160	TÓRICA	O-RING
40	REC93606-12019	93606-12019	PASADOR	PIN
41	REC61A-44311-00	61A-44311-01	CUERPO BOMBA AGUA	HOUSING, WATER PUMP
42	REC90119-08M14	90119-08M14	TORNILLO CON ARANDELA	SCREW WITH WASHER



REF	OEM
REC61A-W0078-A1	61A-W0078-A3

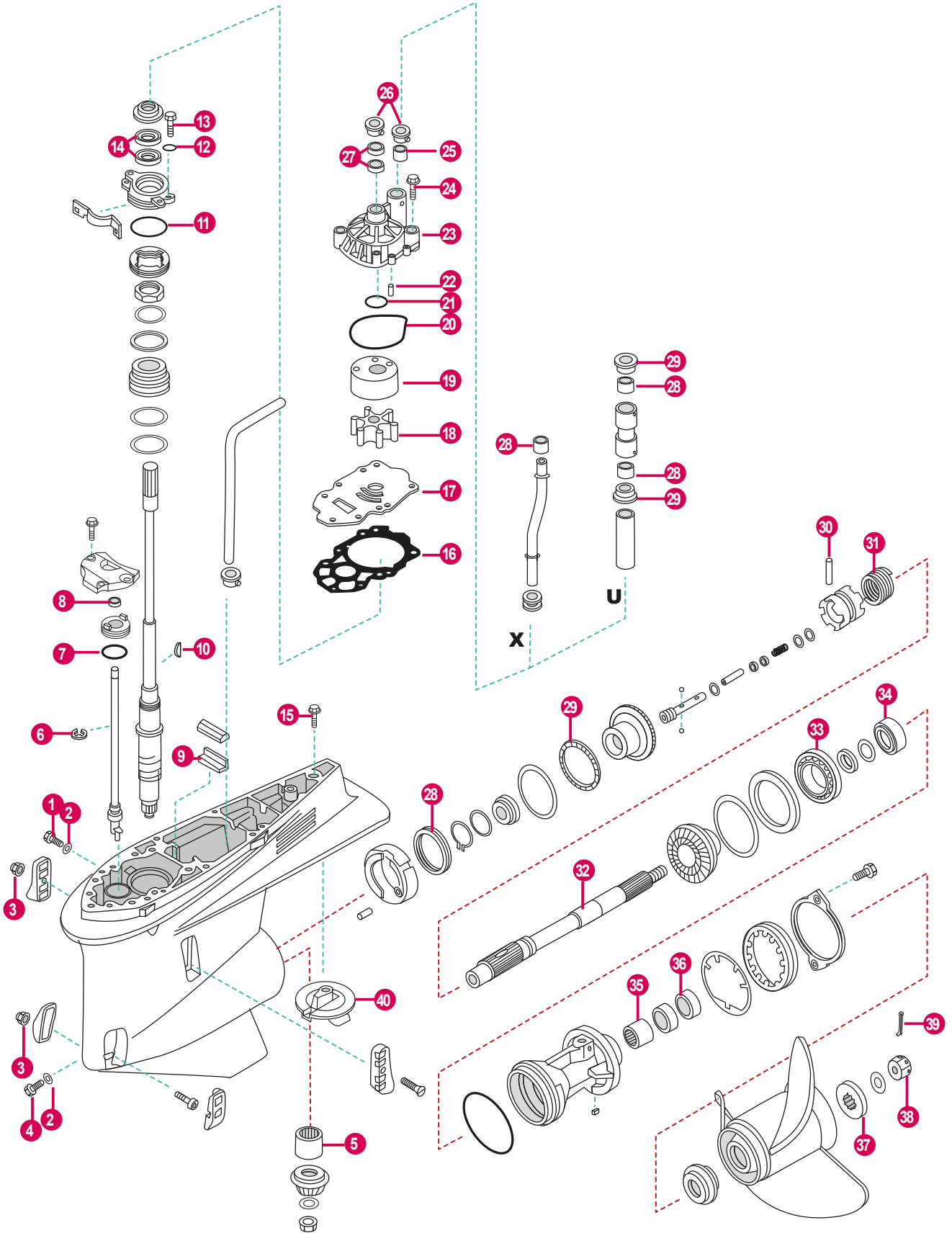

	REF	OEM		
1	REC90340-08002	90304-08002	TORNILLO DRENAJE	BOLT, DISCHARGING OIL
2	REC90430-08020	90430-08020	JUNTA	GASKET
3	PAGB/T6182-M5	90185-05002	TUERCA	LOCK NUT
4	REC688-45341-00	688-45341-10	TORNILLO DRENAJE	BOLT, DISCHARGING OIL
5	REC93311-83280	93311-83280	COJINETE	BEARING
6	REC99001-08600-00	99001-08600	ARANDELA	WASHER
7	PAJASOF404-19-033	93210-33M49	TÓRICA	O-RING
8	REC93106-09014	93106-09014	RETÉN DE ACEITE	OIL SEAL
9	REC663-45376-00	663-45376-00	GUÍA DE SELLO DE GOMA	GUIDE RUB. SEAL
10	REC90280-04002	90280-04002	CUÑA	KEY WOODRUFF
11	REC93210-65752-00	93210-64488	TÓRICA	O-RING
12	PAGB/T97.1-8	92995-08600	ARANDELA	WASHER
13	PAF4-04000001	97095-08020	PERNO	STUD
14	REC93101-28M16	93101-28M16	RETÉN DE ACEITE	OIL SEAL
15	PAT85-00000012	90105-10M00	TORNILLO	BOLT
16	REC6CE-44315-00	6CE-44315-00	JUNTA	GASKET
17	REC6CE-44323-01	6CE-44323-01	TAPA BOMBA	OUTER PLATE, CARTRIDGE
18	REC6CE-44352-00	6CE-44352-01	TURBINA	IMPELLER
19	REC6AW-44322-00	6AW-44322-00	TAPA, BOMBA AGUA	COVER, INNER WATER PUMP
20	REC93210-94003	93210-94003	TÓRICA	O-RING
21	REC93210-37M67	93210-37160	TÓRICA	O-RING
22	REC93606-12019	93606-12019	PASADOR	PIN
23	REC6CE-44311-01	6CE-44311-01	CUERPO BOMBA AGUA	HOUSING, WATER PUMP
24	REC90119-08M14	90119-08M14	TORNILLO CON ARANDELA	SCREW WITH WASHER
25	REC6AW-44365-00	6AW-44365-00	GOMA DEL SELLO DE AGUA	DAMPER, WATER SEAL
26	REC6AW-44312-00	6AW-44312-00	CUBIERTA CAJA DE BOMBA DE AGUA	WATER PUMP COVER
27	REC93104-22M07	93104-22M07	RETÉN DE ACEITE	OIL SEAL
28	REC93311-85894	93311-85894	COJINETE	BEARING
29	REC93340-67011	93340-67011	COJINETE	BEARING
30	REC90250-08M07	90250-08M07	PASADOR	PIN
31	REC6E5-45633-01	6E5-45633-01	ANILLO DEL PASADOR	ANULAR SPRING, CLUTCH
32	REC6CB-45611-00	6CB-45611-00	EJE	SHAFT
33	REC93306-209U0	93306-209U0	COJINETE	BEARING
34	REC93332-000A5	93332-000A5	COJINETE	BEARING
35	REC93315-43061	93315-43061	COJINETE	BEARING
36	REC93101-30002	93101-300002	RETÉN DE ACEITE	OIL SEAL
37	REC688-45997-00	688-45997-01	ESPACIADOR	SPACER
38	REC90171-18M04	90171-18M04	TUERCA	LOCK NUT
39	REC91490-30025	91490-40030	PASADOR	PIN
40	REC61A-45371-00AL	61A-45371-00	ÁNODO	ÁNODO

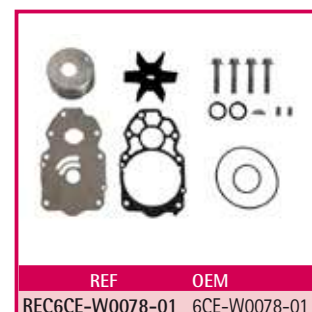

REF	OEM
REC6CE-W0078-01	6CE-W0078-01

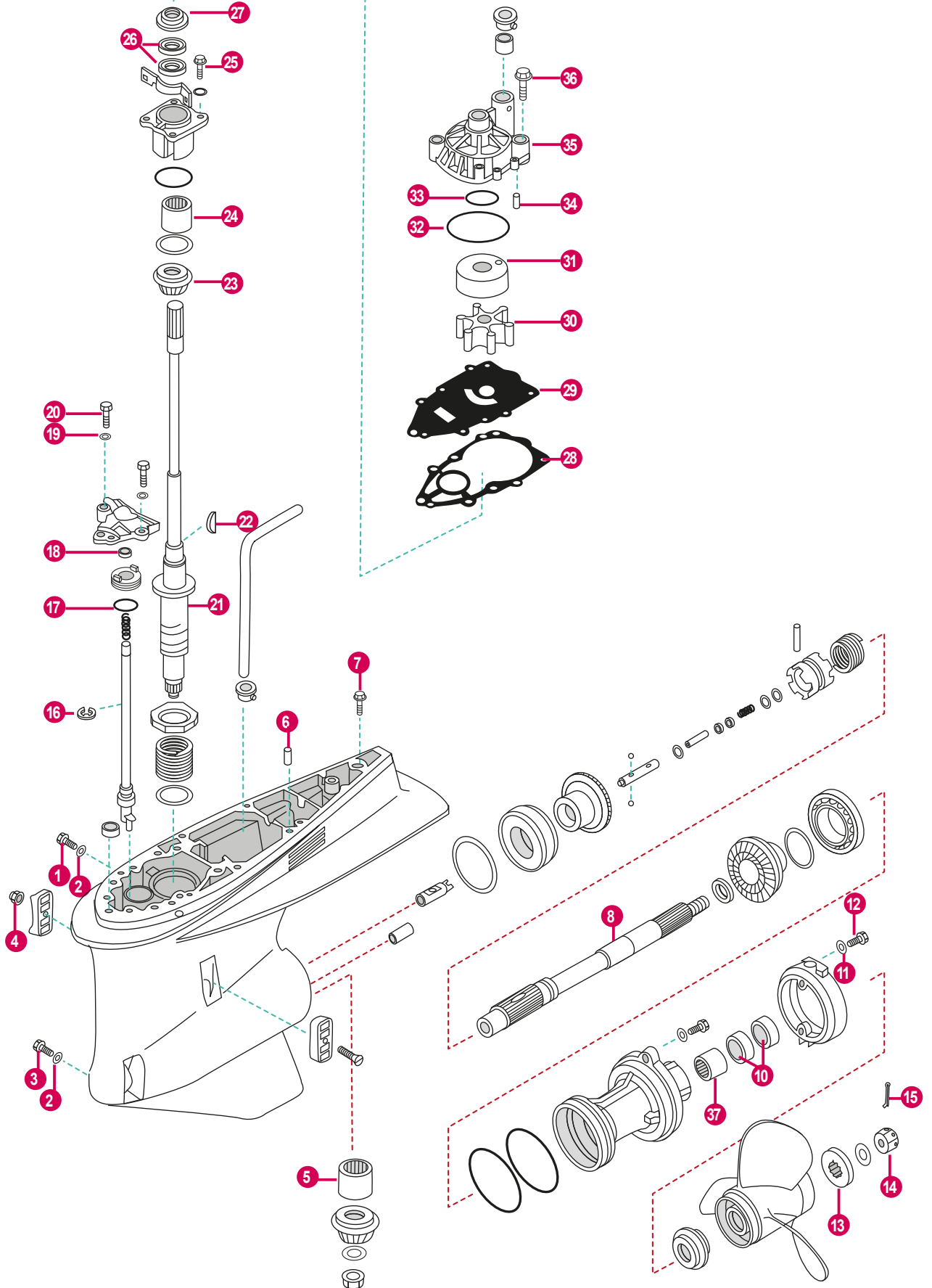

	REF	OEM		
1	REC90340-08002	90304-08002	TORNILLO DRENAJE	BOLT, DISCHARGING OIL
2	REC90430-08020	90430-08020	JUNTA	GASKET
3	REC688-45341-00	688-45341-10	TORNILLO DRENAJE	BOLT, DISCHARGING OIL
4	PAGB/T6182-M5	90185-05002	TUERCA	LOCK NUT
5	REC93311-83280	93311-83280	COJINETE	BEARING
6	REC93608-12M05	93608-12M05	PASADOR	PIN
7	PAT85-00000012	90105-10M00	TORNILLO	SCREW
8	REC69J-45611-00	69J-45611-00	EJE	SHAFT
	REC69K-45611-00	69K-45611-00	EJE CONTRARROTACIÓN	CR SHAFT
10	REC93101-30002	93101-300002	RETÉN DE ACEITE	OIL SEAL
11	PAF4-04000001	97095-08020	PERNO	BOLT
12	PAGB/T97.1-8	92995-08600	ARANDELA	WASHER
13	REC688-45997-00	688-45997-01	ESPACIADOR	SPACER
14	REC90171-18M04	90171-18M04	TUERCA	LOCK NUT
15	REC91490-30025	91490-40030	PASADOR	PIN
16	REC99001-08600-00	99001-08600	CLIP	CLIP
17	PAJASOF404-19-033	93210-33M49	TÓRICA	O-RING
18	REC93106-09014	93106-09014	RETÉN DE ACEITE	OIL SEAL
19	PAGB/T96-6	92995-06600	ARANDELA	WASHER
20	PAGB/T5783-M6X16	97095-06016	PERNO	BOLT
21	REC6P2-45501-11	6P2-45501-10	EJE TRANSMISION U (30.3")	DRIVE SHSFT U (30.3")
	REC6P2-45501-01	6P2-45501-00	EJE TRANSMISION X (25.3")	DRIVE SHSFT X (25.3")
22	REC90280-04M05	90280-04M05	CUÑA	KEY WOODRUFF
23	REC93341-93020	93341-930U9	COJINETE	BEARING
24	REC93315-430V5	93317-330U2	COJINETE	BEARING
25	PAGB/T5783-M8X25	97095-08025	PERNO	BOLT
26	REC93101-28M16	93101-28M16	RETÉN DE ACEITE	OIL SEAL
27	REC6E5-45344-00	6E5-45344-00	TAPA RETEN	RETAINER
28	REC60X-44315-A0	60X-44315-A0	JUNTA	GASKET
29	REC6P2-44323-00	6P2-44323-00	PLACA EXTERIOR DEL CARTUCHO	OUTER PLATE
30	REC6E5-44352-01	6E5-44352-01	TURBINA	IMPELLER
31	REC61A-44322-02	61A-44322-02	TAPA, BOMBA AGUA	COVER, INNER WATER PUMP
32	REC93210-86M38	93210-86M38	TÓRICA	O-RING
33	REC93210-37M67	93210-37160	TÓRICA	O-RING
34	REC93606-12019	93606-12019	PASADOR	PIN
35	REC61A-44311-00	61A-44311-01	CUERPO BOMBA AGUA	HOUSING, WATER PUMP
36	REC90119-08M14	90119-08M14	TORNILLO CON ARANDELA	SCREW WITH WASHER
37	REC93315-43064	93315-43064	RODAMIENTO DEL DIÁBOLO	CARRIER BEARING



REF	OEM
REC6P2-W0078-00	61P2-W0078-00

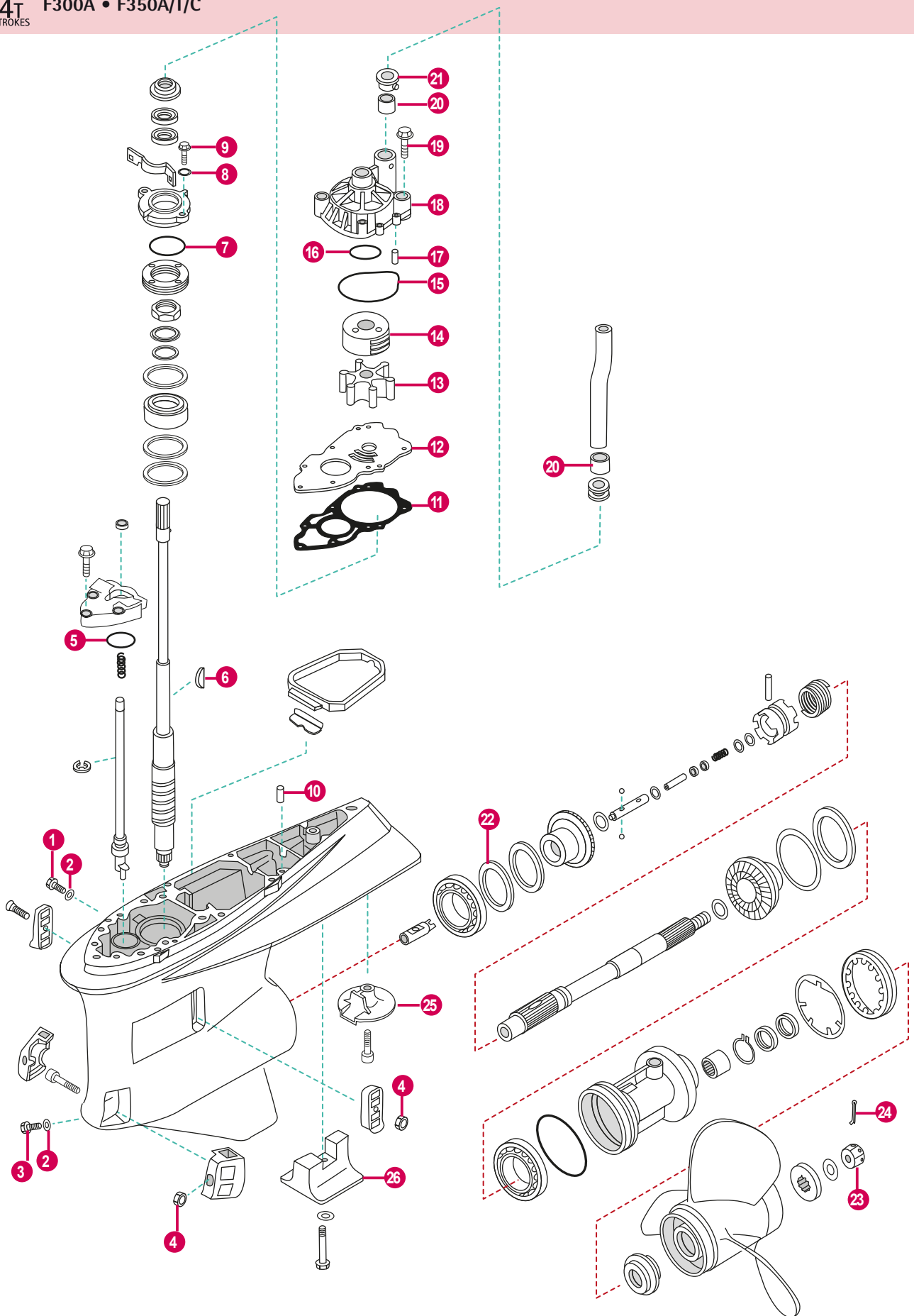

	REF	OEM		
1	REC90340-08002	90304-08002	TORNILLO DRENAJE	BOLT, DISCHARGING OIL
2	REC90430-08020	90430-08020	JUNTA	GASKET
3	REC688-45341-00	688-45341-10	TORNILLO DRENAJE	BOLT, DISCHARGING OIL
4	PAGB/T6182-M5	90185-05002	TUERCA	LOCK NUT
5	REC93210-48214	93210-48214	TÓRICA	O-RING
6	REC6AW-44336-00	6AW-44336-00	CUÑA	KEY WOODRUFF
7	REC93210-69MG6	93210-69MG6	TÓRICA	O-RING
8	PAGB/T97.1-8	92995-08600	ARANDELA	WASHER
9	PAF4-04000001	97095-08020	PERNO	BOLT
10	REC93608-12M05	93608-12M05	PASADOR	PIN
11	REC6AW-44315-00	6AW-44315-00	JUNTA	GASKET
12	REC6AW-44323-00	6AW-44323-00	TAPA BOMBA	OUTER PLATE, CARTRIDGE
13	REC6AW-44352-00	6AW-44352-00	TURBINA	IMPELLER
14	REC6AW-44322-00	6AW-44322-00	TAPA, BOMBA AGUA	COVER, INNER WATER PUMP
15	REC93210-94003	93210-94003	TÓRICA	O-RING
16	REC93210-37M67	93210-37160	TÓRICA	O-RING
17	REC93606-12019	93606-12019	PASADOR	PIN
18	REC6AW-44311-01	6AW-44311-00	CUERPO BOMBA AGUA	HOUSING, WATER PUMP
19	REC90119-08M14	90119-08M14	TORNILLO CON ARANDELA	SCREW WITH WASHER
20	REC6AW-44365-00	6AW-44365-00	GOMA DEL SELLO DE AGUA	DAMPER, WATER SEAL
21	REC6AW-44312-00	6AW-44312-00	CUBIERTA CAJA DE BOMBA DE AGUA	WATER PUMP COVER
22	REC93340-67011	93340-67011	COJINETE	BEARING
23	REC90171-18M04	90171-18M04	TUERCA	LOCK NUT
24	REC91490-30025	91490-40030	PASADOR	PIN
25	REC6AW-45619-00AL	67F-45371-00	ÁNODO	ÁNODO
26	REC6AW-45373-00AL	67F-45371-00	ÁNODO	ÁNODO



REF	OEM
REC6AW-W0078-00	6AW-W0078-00

DESPIECE COLAS
2 TIEMPOS

GEAR CASE PARTS
2 STROKES

2T 2HP • 2B • 2MSH • 2CMH
STROKES

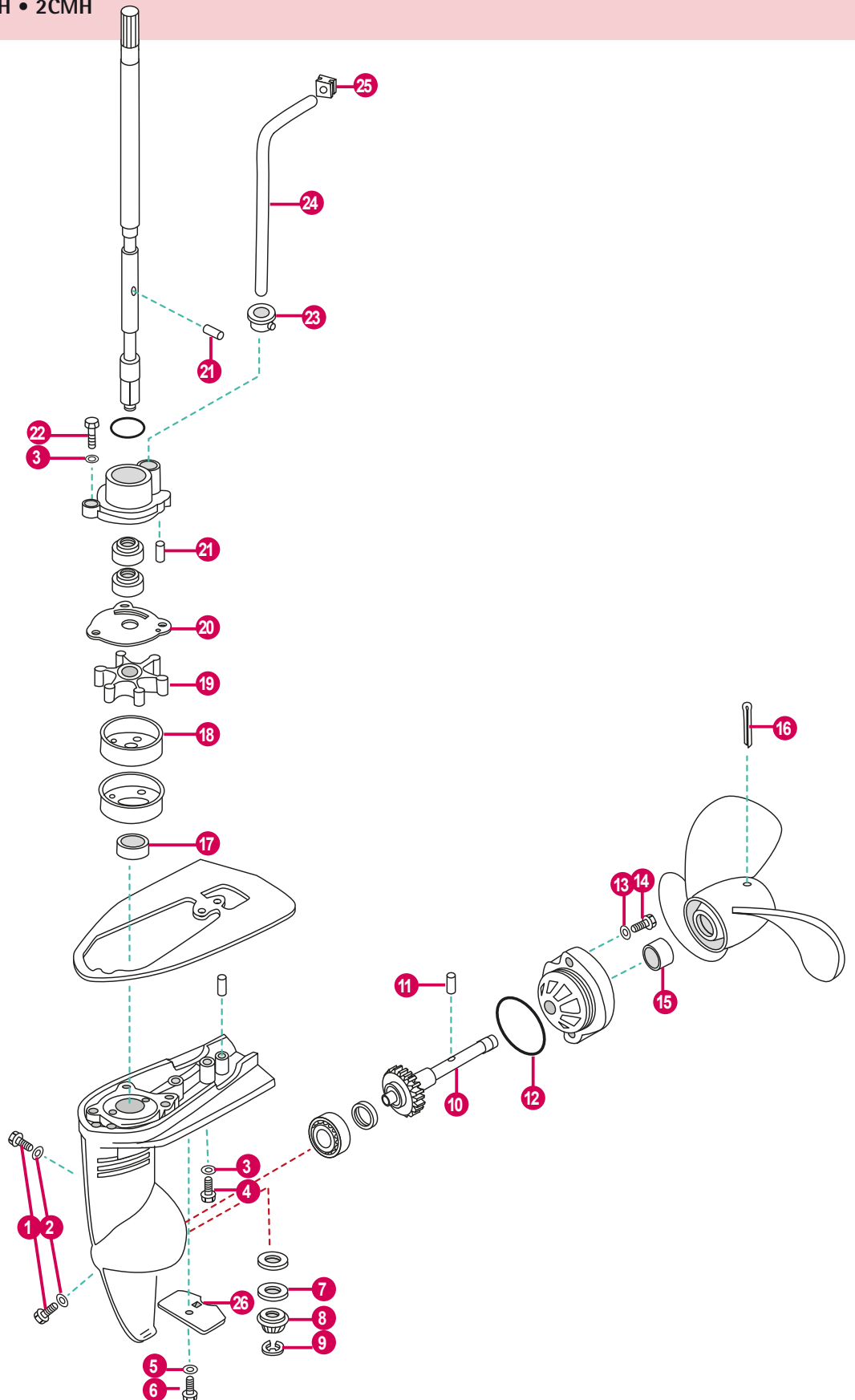

	REF	OEM		
1	REC90340-08002	90340-08M04	TORNILLO DRENAJE	BOLT, DISCHARGING OIL
2	REC90430-08020	90430-08020	JUNTA	GASKET
3	PAGB/T97.1-8	92995-08600	ARANDELA	WASHER
4	PAGB/T5783-M6X30	97095-06030	TORNILLO	BOLT
5	PAGB/T861.1-87	92990-06300	ARANDELA	WASHER
6	PAGB/T5783-M6X35	95895-06012	TORNILLO	BOLT, FLANGE
7	PAF4-03000006	90201-11M49	ARANDELA	WASHER
8	REC646-45551-00	646-45551-00	PIÑÓN ATAQUE	INITIATIVE GEAR
9	PAGB/T896-86	93430-06005	CLIP	CIRCLIP
10	REC646-45560-00	646-45560-00	ENGRANAJE CON EJE	GEAR WITH SHAFT
11	REC90250-03M10	90250-03M10	PASADOR SEGURIDAD	PIN
12	REC93210-42101	93210-42101	ARO TÓRICA	O-RING
13	PAGB/T96-6	92990-06600	ARANDELA	WASHER
14	PAGB/T5783-M6X16	97090-06014	TORNILLO	BOLT
15	REC93103-10052	93103-10052	RETÉN	OIL SEAL
16	REC91490-30040	91490-30040	PASADOR ALETAS	PIN
17	REC93103-11051	93103-11051	RETÉN	OIL SEAL
18	REC646-44322-00	646-44322-00	CASQUILLO INOX. BOMBA	INSERT
19	REC646-44352-01	646-44352-01	TURBINA	IMPELLER
20	REC646-44322-00	646-44323-00	PLATO BOMBA AGUA	OUTER PLATE
21	PAF2.6-03000013	93604-09068	PIN	PIN
22	PAGB/T5783-M5X16	97095-05016	TORNILLO	BOLT
23	REC646-44366-01	646-44366-01	RETÉN TUBO AGUA	SEAL WATER PIPE
24	REC6A1-44361-00	6A1-44361-00	TUBO AGUA	TUBE, WATER
25	REC646-44365-00	646-44365-00	RETÉN TUBO DE AGUA	I-SHAPED RUBBER BAND
26	REC6L5-45251-03AL	6L5-45251-02	ÁNODO	ÁNODE



REF	OEM
REC6A1-W0078-01	6A1-W0078-01

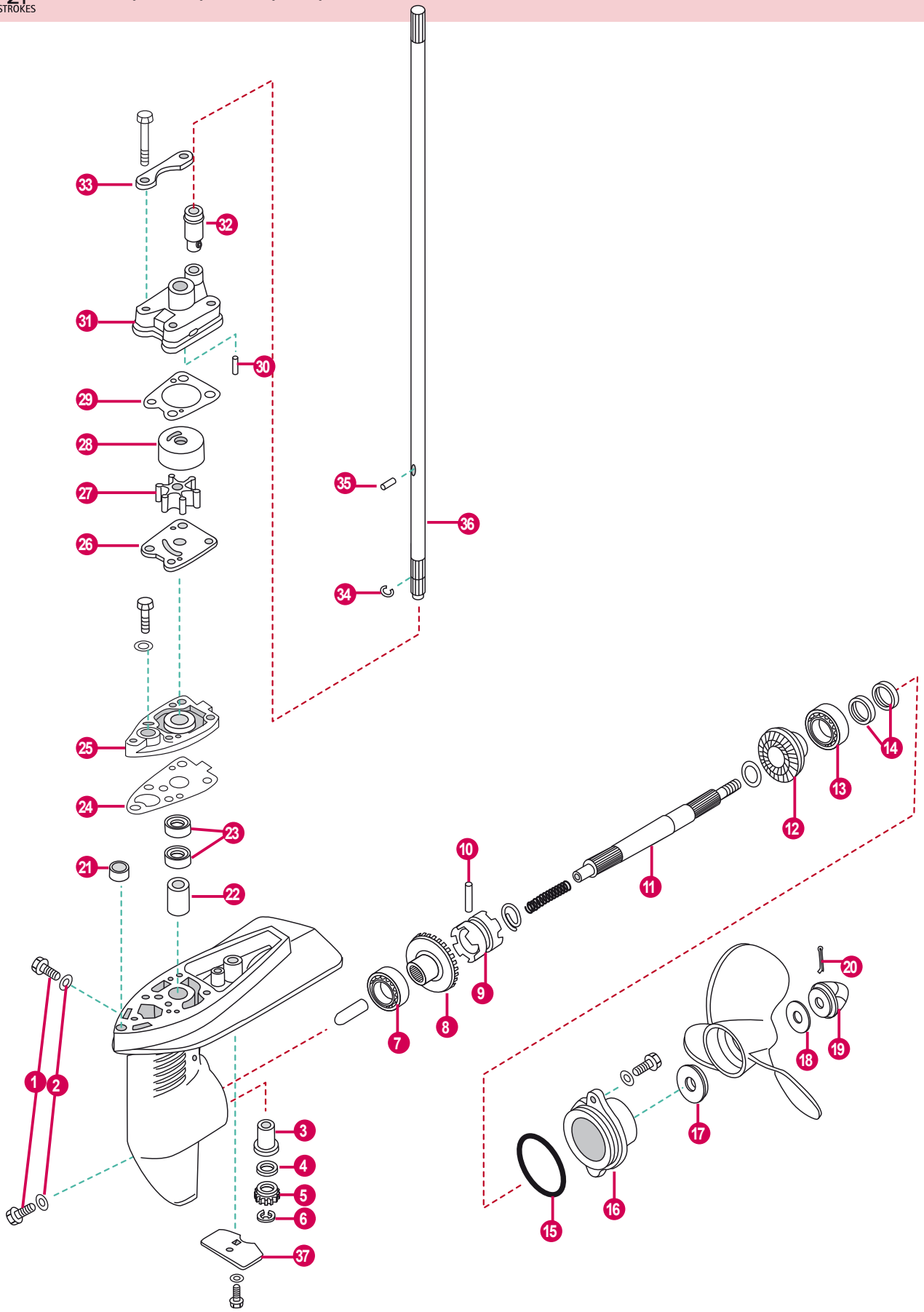

	REF	OEM		
1	REC90340-08002	90340-08002	TAPÓN ACEITE	PLUG, OIL
2	REC90430-08020	90430-08020	JUNTA	GASKET
3	REC6E0-45317-00	6E0-45317-09	CASQUILLO EJE	BUSHING
4	PAF4-03000006	90204-11M49	ARANDELA	WASHER
5	REC6E0-45551-00	6E0-45551-00	PIÑÓN ATAQUE	INITIATIVE GEAR
6	PAGB/T896-86	99001-06600	CIRCLIP	CIRCLIP
7	PAGB/T276-6004C2	93306-004U0	RODAMIENTO	BEARING
8	REC6E0-45560-00	6E0-45560-00	PIÑÓN MARCHA AVANTE	POSITIVE GEAR ASSY
9	REC6E0-45631-00	6E0-45631-00	DESPLAZABLE	CLUTCH, DOG
10	REC90250-05046	90250-05046	PASADOR	PIN STRAIGHT
11	REC6E0-45611-01	6E0-45611-01	EJE HÉLICE	SHAFT, PROPELLER
12	REC6E0-45570-00	6E0-45570-00	PIÑÓN MARCHA ATRÁS	REVERSE GEAR
13	PAGB/T276-6004C2	93306-004U0	RODAMIENTO	BEARING
14	REC93101-13M12	93101-13M12	RETÉN	OIL SEAL
15	REC93210-48214	93210-48214	ARO TÓRICO	O-RING
16	PAF4-03050001	6E0-45361-01-4D	TAPA CÁRTER	COVER, LOWER CASING
17	PAF4-03000025	6L5-45987-01	ESPACIADOR	SPACER
18	PAF4-03000026	90201-08M54	ARANDELA INOX.	WASHER, STAINLESS STEEL
19	REC647-45616-02	6L5-45616-02	TUERCA	NUT, PROPELLER
20	PAGB/T91-1.6X12	91490-25030	PASADOR ALETAS	PIN, COTTER
21	PAF4-00000001	90387-06M14	COLLAR	COLLAR
22	REC6E0-45316-00	6E0-45316-09	CASQUILLO EJE	BUSHING
23	REC93101-10M14	93101-10M14	RETÉN	OIL SEAL
24	PAF4-03000011	6E0-45315-A0	JUNTA	PACKING
25	PAF4-03000012	6E0-45321-01-5B	BASE BOMBA DE AGUA	BASE, WATER PUMP
26	PAF4-03000015	6E0-44323-00	PLACA	OUTER PLATE
27	REC6E0-44352-00	6E0-44352-00	IMPULSOR	IMPELLER
28	REC6E0-44322-02	6E0-44322-02	CASQUILLO INOX	CARTRIDGE INSERT
29	PAF4-03000018	6E0-44315-A0	JUNTA BOMBA	GASKET
30	PAF4-03000013	93604-18080	PIN	PIN, DOWEL
31	PAF4-03000019	6E0-44311-00	CUERPO BOMBA	HOUSING, WATER PUMP
32	PAF4-03000021	6E0-44366-00	RETÉN GOMA, BOMBA DE AGUA	RUBBER TUBE, WATER PUMP
33	PAF4-03000020	6E0-44328-00	PLACA FIJACIÓN BOMBA DE AGUA	PLATE, WATER PUMP FIXED
34	PAF4-03000005	90467-08M01	CLIP	CLIP
35	PAF4-03000016	93604-09066	PIN	PIN, DOWEL
36	REC6E0-45511-01	6E0-45511-01	EJE VERTICAL S	SHAFT, DRIVE S
	REC6E0-45511-11	6E0-45511-11	EJE VERTICAL L	SHAFT, DRIVE L
37	REC6L5-45251-03AL	6L5-45251-02	ÁNODO	ÁNODE



2T 6HP/C/MSH/CMH/CWH/MBK'07/D/DMH/DWH
STROKES 8HP/C/MSH/MH/CMH/CWH

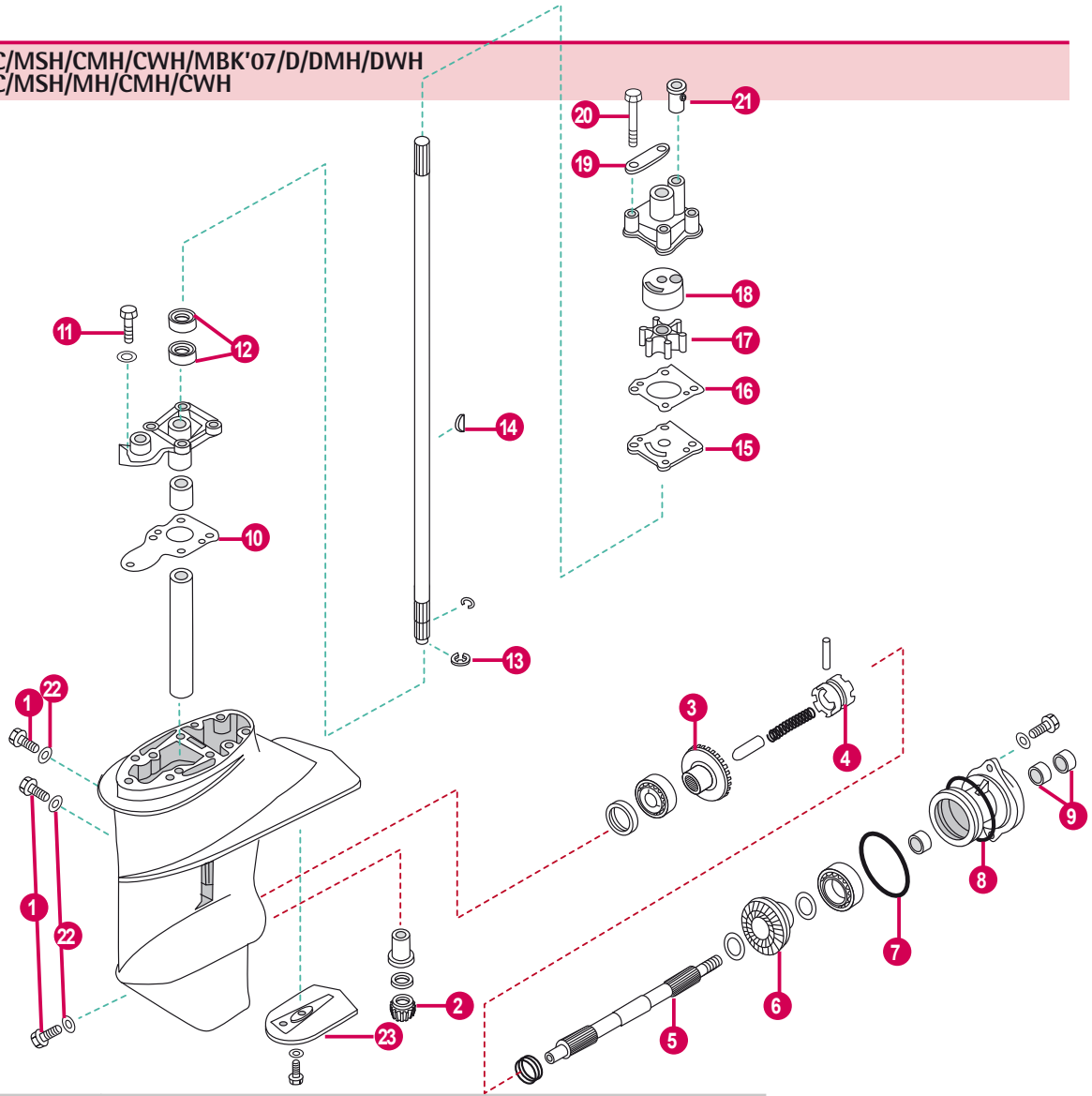

REF	OEM		
1	REC90340-08002	6E0-45316-09	TAPÓN PLUG
2	REC6N0-G5551-00	6N0-G5551-00	PIÑÓN ATAQUE INITIATIVE GEAR
3	REC6N0-G5560-00	6N0-G5560-00	PIÑÓN MARCHA AVANTE POSITIVE GEAR ASSY
4	REC6G1-45631-00	6G1-45631-00	EMBRAGUE DE GARRA CLUTCH, DOG
5	REC6G1-45611-01	6G1-45611-01	EJE HÉLICE SHAFT, PROPELLER
6	REC6N0-G5571-00	6N0-G5571-00	PIÑÓN MARCHA ATRÁS REVERSE GEAR
7	REC93210-49046	93210-49046	ARO TÓRICO O-RING
8	REC93210-53M08	93210-53M08	ARO TÓRICO O-RING
9	REC93101-15074	93101-15074	RETÉN OIL SEAL
10	REC6G1-45315-A0	6G1-45315-A0	JUNTA PACKING, LOWER CASING
11	PAGB/T5783-M6X30	97095-06030	TORNILLO BOLT
12	REC93101-11M23	93101-11M23	RETÉN OIL SEAL
13	REC99001-06600	99001-06600	CERCLIP CIRCLIP
14	REC90280-03024	90280-03024	CHAVETA KEY
15	REC6G1-44323-00	6G1-44323-00	PLATO OUTER PLATE, CARTRIDGE
16	REC6G1-44315-A0	6G1-44315-A0	JUNTA GASKET, WATER PUMP
17	REC6G1-44352-00	6G1-44352-00	TURBINA IMPELLER
18	REC6G1-44322-00	6G1-44322-00	CASQUILLO INSERT, CARTRIDGE
19	REC6G1-44328-00	6G1-44328-00	PLACA FIJACIÓN BOMBA DE AGUA PLATE, WATER PUMP FIXED
20	REC97095-06045	97095-06045	TORNILLO BOLT
21	REC647-44366-00	647-44366-00	CASQUILLO GOMA DAMPER
22	REC90430-08020	90430-08020	JUNTA GASKET
23	REC6N0-WG525-00AL	6N0-WG525-00	ÁNODO ÁNODE



REF	OEM
REC6G1-W0078-A1	6G1-W0078-A1



REF	OEM
REC6G1-W0001-C1	6N0-W0001-20

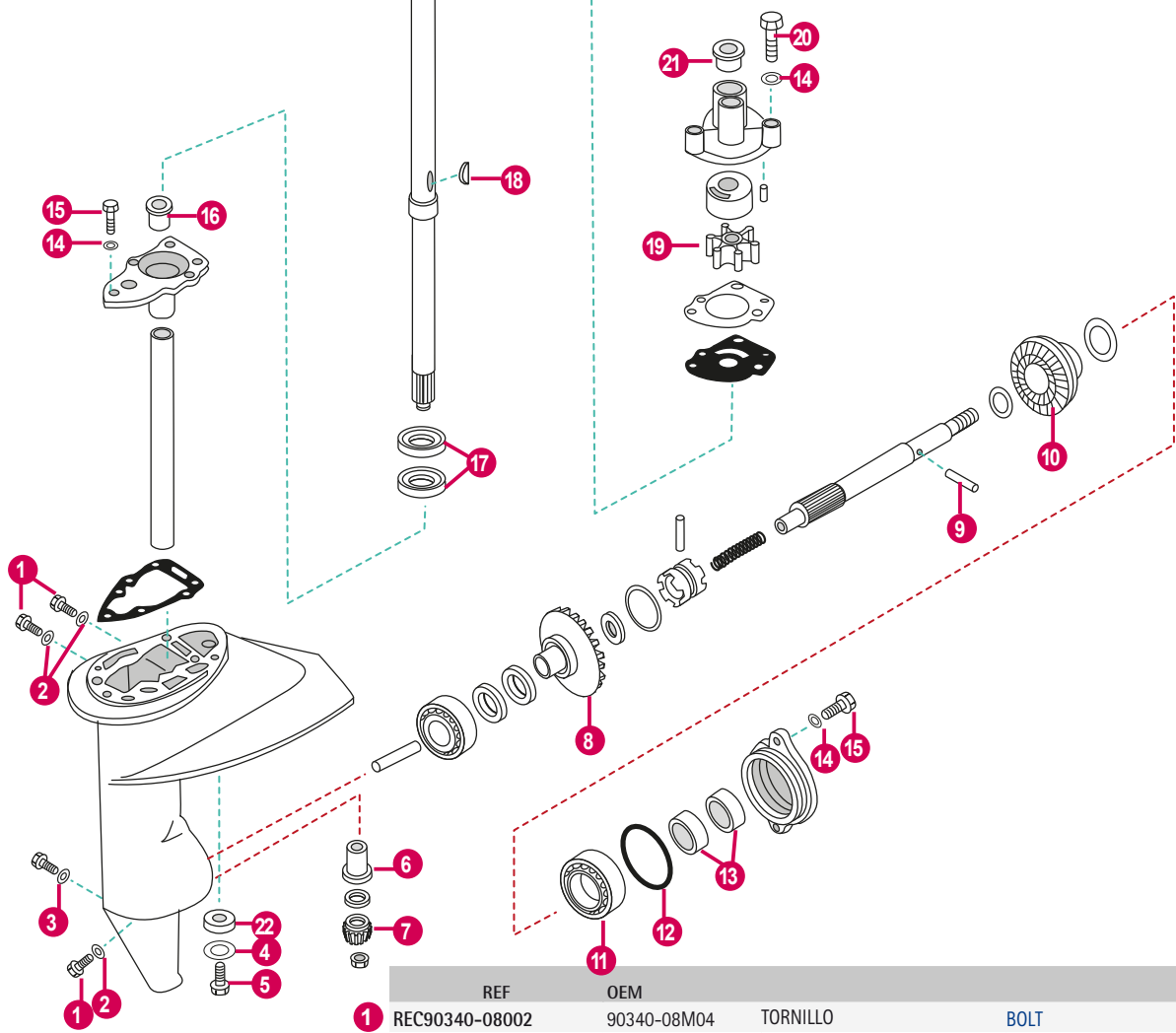

	REF	OEM		
1	REC90340-08002	90340-08M04	TORNILLO	BOLT
2	REC90430-08020	90430-08020	JUNTA	GASKET
3	REC90430-06M03	90430-06M03	JUNTA	GASKET
4	PAGB/T861.1-87	92990-06300	ARANDELA	WASHER
5	PAGB/T5783-M6X35	95895-06012	TORNILLO	BOLT
6	REC647-45316-09	647-45316-09	CASQUILLO	DAMPER
7	REC647-45551-00	647-45551-00	PIÑÓN ATAQUE	INITIATIVE GEAR
8	REC647-45560-00	647-45560-00	PIÑÓN MARCHA AVANTE	POSITIVE GEAR ASSY
9	REC90250-05036	90250-05036	PASADOR	PIN
10	REC647-45570-00	647-45570-01	PIÑÓN MARCHA ATRÁS	REVERSE GEAR
11	REC93306-00519	93306-00519	COJINETE	BEARING
12	REC93210-58677	93210-58677	ARO	O-RING
13	REC93101-15074	93101-15074	RETÉN ACEITE	OIL SEAL
14	PAGB/T96-6	92990-06600	ARANDELA	WASHER
15	PAGB/T5783-M6X20	97095-06020	PERNO	BOLT
16	REC647-45316-09	647-45316-09	CASQUILLO	BUSH
17	REC93101-18050	93101-18050	RETÉN ACEITE	OIL SEAL
18	REC90280-03024	90280-03024	CHAVETA	KEY
19	REC662-44352-01	662-44352-01	IMPULSOR	IMPELLER
20	REC97095-06040	97095-06040	PERNO	BOLT
21	REC647-44366-00	647-44366-00	GOMA	RUBER BAND
22	REC6E0-45251-12AL	6E0-45251-12	ÁNODO	ÁNODO

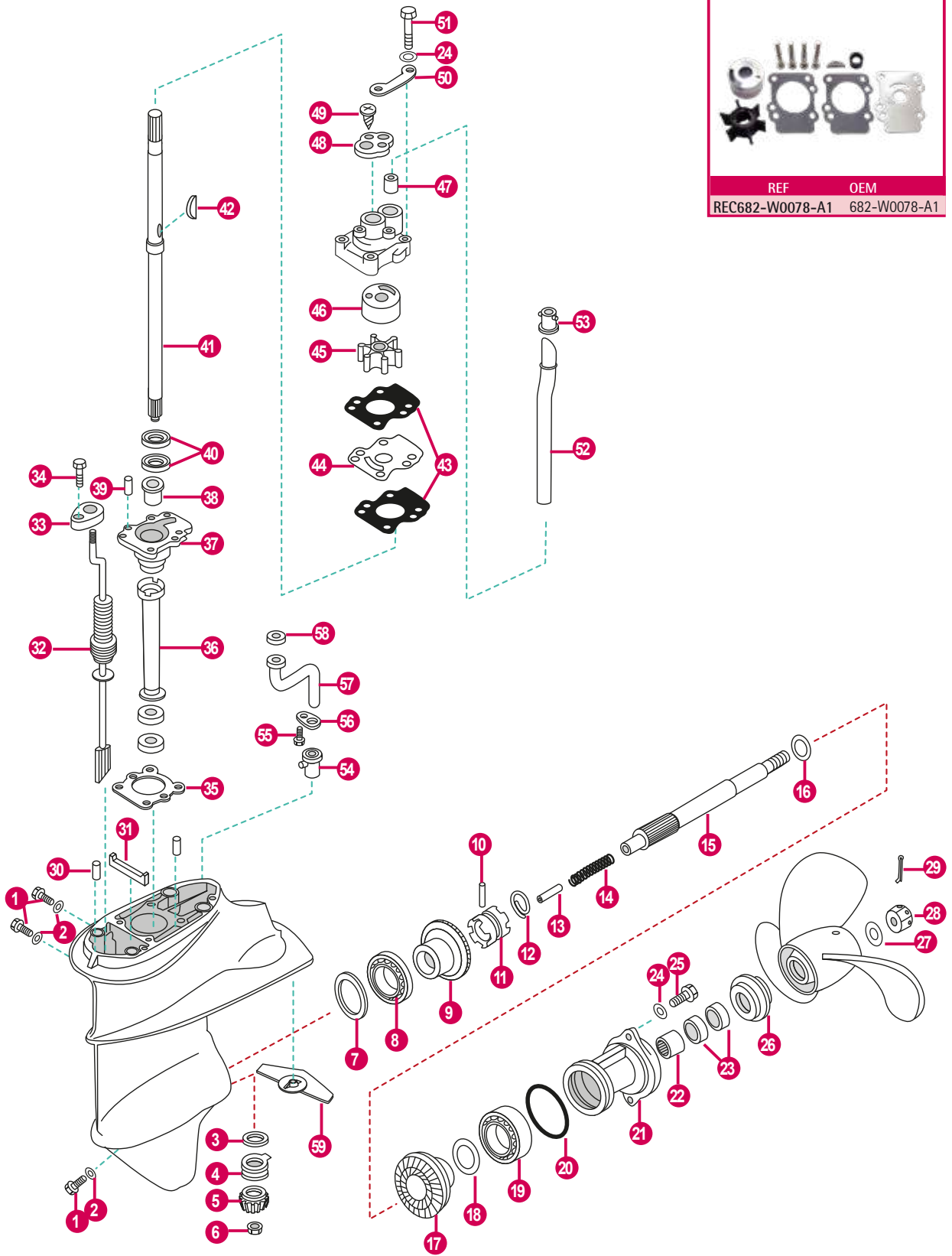

	REF	OEM		
1	REC90340-08002	90340-08014	TAPÓN	PLUG, STRAIGHT SCREW
2	REC90430-08020	90430-08020	JUNTA	GASKET
3	PAF15-06000009	6E7-45587-01-30	GRUESO (1.20mm)	SHIM (1.20mm)
4	REC93341-214U1	93341-214U1	RODAMIENTO	BEARING
5	REC6E7-45551-00	6E7-45551-00	PIÑÓN ATAQUE	INITIATIVE GEAR
6	REC90179-08M06	90179-08M06	TUERCA	NUT
	PAF15-06000010-1	664-45567-05	GRUESO (0.05mm)	SHIM (0.05mm)
	PAF15-06000010-2	664-45567-12	GRUESO (0.12mm)	SHIM (0.12mm)
7	PAF15-06000010-5	664-45567-30	GRUESO (0.30mm)	SHIM (0.30mm)
	PAF15-06000010-7	664-4556-50	GRUESO (0.50mm)	SHIM (0.50mm)
8	REC93332-00005	93332-00005	RODAMIENTO	BEARING
9	REC6E7-45560-01	6E7-45560-00	PIÑÓN MARCHA AVANTE	POSITIVE GEAR ASSY
10	REC90250-05010	90250-05010	PASADOR	PIN, STRAIGHT
11	REC682-45631-00	682-45631-00	EMBRAGUE DE GARRA	CLUTCH, DOG
12	REC648-45633-00	648-45633-00	ANILLO	RING, CROSS PIN
13	REC650-45635-00	650-45635-00	PISTÓN	PLUNGER, SHIFT
14	PAF15-06070002	90501-14M06	MUELLE	SPRING, COMPRESSION
15	REC683-45611-00	683-45611-00	EJE HÉLICE	SHAFT, PROPELLER
16	REC90201-17682	90201-17682	ARANDELA	WASHER, PLATE
17	REC6E7-45570-00	6E7-45571-00	PIÑÓN MARCHA ATRAS	REVERSE GEAR
	PAF15-06080006-1	626-45577-00-01	GRUESO (0.10mm)	SHIM (0.10mm)
18	PAF15-06080006-3	626-45577-00-03	GRUESO (0.30mm)	SHIM (0.30mm)
	PAF15-06080006-5	626-45577-00-05	GRUESO (0.50mm)	SHIM (0.50mm)
19	REC93306-00501	93306-00501	RODAMIENTO	BEARING
20	REC93210-57M09	93210-57M09	ARO TÓRICO	O-RING
21	REC683-45361-01-4D	683-45361-00-EJ	DIÁBOLO	CAP. LOWER CASING
22	REC93315-317U2	93315-317U2	RODAMIENTO	BEARING
23	REC93101-17054	93101-17054	RETÉN	OIL SEAL
24	PAGB/T96-6	92990-06600	ARANDELA	WASHER, PLATE
25	PAGB/T5783-M6X20	97395-06020	TORNILLO	BOLT
26	REC6E7-45987-00	6E7-45987-00	ESPACIADOR	SPACER
27	PAGB/T96-10	90201-10M01	SEPARADOR	SPACER
28	PAF15-06000016	90171-10M01	TUERCA HÉLICE	NUT, CASTLE
29	PAGB/T91-2.5X20	91490-30020	PASADOR ALETAS	PIN, COTTER
30	REC93606-12019	93606-12019	PIN	PIN
31	REC682-45376-01	682-45376-01	GUÍA RETÉN	GUIDE, SEAL DAMPER
32	REC682-44147-00	682-44147-00	TAPÓN GUÍA	BOOT, SHIFT ROD
33	REC682-44176-00	682-44176-00	SOPORTE	BRACKET
34	PAGB/T845-ST4.8X9	97780-50510	TORNILLO	SCREW
35	REC683-45315-A0	683-45315-00	JUNTA	PACKING, LOWER CASING
36	REC6E7-45536-00	6E7-45536-00	CAMISA EJE	SLEEVE, DRIVE SHAFT
37	REC6E7-45331-00-CA	6E7-45331-00-9M	CUERPO DE RODAMIENTO	HOUSING, BEARING
38	REC626-45316-09	626-45316-09	CASQUILLO	BUSHING, DRIVE SHAFT
39	REC93606-12019	93606-12019	PIN	PIN, DOWEL
40	REC93101-20048	93101-20048	RETÉN	OIL SEAL

	REF	OEM		
41	REC6E7-45501-00	6E7-45501-00	EJE S	DRIVE SHAFT COMP. S
	REC6E7-45501-11	6E7-45501-10	EJE L	DRIVE SHAFT COMP. L
42	REC90280-03024	90280-03024	CHAVETA	KEY, WOODRUFF
43	REC682-44315-00	682-44315-00	JUNTA	GASKET, WATER PUMP
44	REC682-44323-40	682-44323-00	PLATO	OUTER PLATE, CARTRIDGE
45	REC682-44352-01	682-44352-00	TURBINA	IMPELLER
46	REC682-44322-00	682-44322-00	CASQUILLO INOX.	INSERT, CARTRIDGE
47	REC682-44365-00	682-44365-00	CASQUILLO GOMA	DAMPER, WATER SEAL
48	REC682-44312-00	682-44312-00	TAPA CUERPO BOMBA AGUA	COVER, WATER PUMP HOUSING
49	PAGB/T845-ST4.2X16	97780-40112	TORNILLO	SCREW, TAPPING
50	REC682-44328-00	682-44328-00	PLATO	PLATE
51	PAGB/T5782-M6X45	947395-06040	TORNILLO	BOLT
	REC682-44361-01	682-44361-01	TUBO DE AGUA S	WATER TUBE S
52	REC682-44361-10	682-44361-10	TUBO DE AGUA L	WATER TUBE L
53	REC626-44365-01	626-44365-01	RETÉN	SEAL
54	REC6E7-44366-00	6E7-44366-00	CASQUILLO GOMA	WATER SEAL
55	PAGB/T5783-M6X10	97095-06010	TORNILLO	BOLT
56	REC683-44373-00	683-44373-00	PLACA FIJACION TUBO	PLATE WATER TUBE
57	REC683-44362-01	683-44361-01	TUBO DE AGUA	WATER TUBE "B"
58	REC683-44365-01	683-44365-01	CASQUILLO GOMA	SEAL WATER TUBE
59	REC6E8-45251-02AL	6E8-45251-02	ÁNODO	ÁNODE

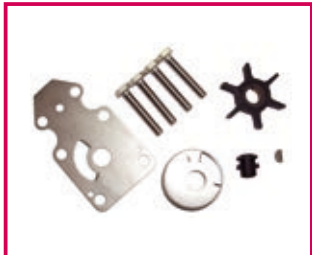
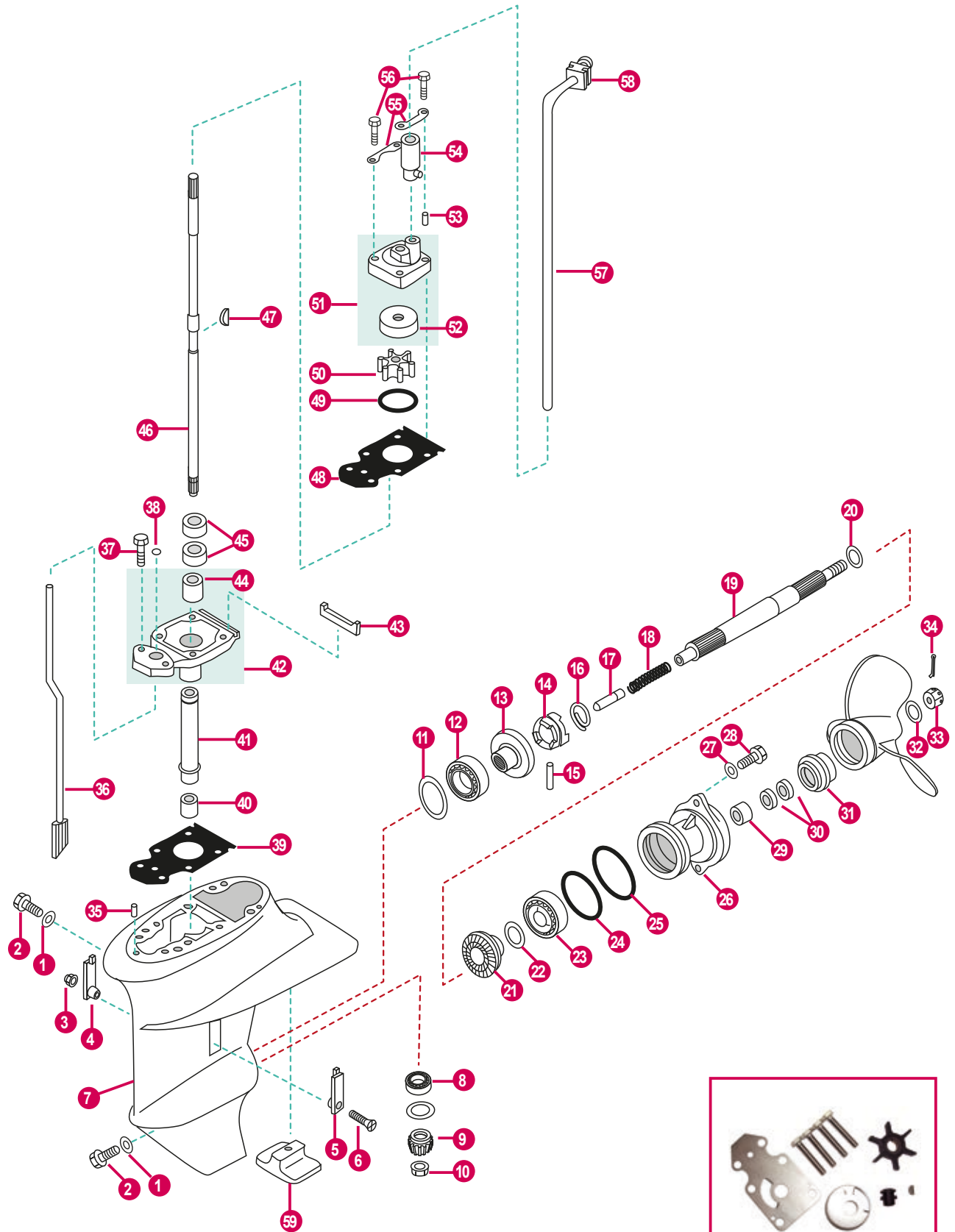

REF	OEM
REC63V-W0078-01	63V-W0078-01

	REF	OEM		
1	REC90430-08020	90430-08020	ARANDELA	WASHER
2	REC90340-08002	90340-08002	TAPÓN ACEITE	PLUG, OIL
3	PAGB/T6182-M5	90185-05002	TUERCA	LOCK NUT
4	PAF15-06000002	63V-45215-00	CUBIERTA ENTRADA AGUA A	WATER INLET A
5	PAF15-06000003	6G1-45214-00	CUBIERTA ENTRADA AGUA B	WATER INLET B
6	PAGB/T820-M5X25	90152-05M04	TORNILLO	SCREW
7	PAF15-06000001	63V-45311-01-4D	CARTER	CASTING, LOWER
8	REC93341-41414	93341-41414	RODAMIENTO	BEARING
9	REC63V-45551-00	63V-45551-00	PIÑÓN ATAQUE	INITIATIVE GEAR
10	REC90179-08M06	90179-08M06	TUERCA	LOCK NUT
11	PAF15-06000010-1	664-45567-01-10	GRUESO	SHIM
12	REC93332-00005	93332-00005	COJINETE	BEARING
13	REC6E7-45560-01	6E7-45560-01	PIÑÓN MARCHA AVANTE	POSITIVE GEAR ASSY
14	REC682-45631-00	682-45631-00	SELECTOR	CLUTCH BLOCK
15	REC90250-05010	90250-05010	PASADOR	PIN
16	REC648-45633-00	648-45633-00	MUELLE SELECTOR	RING, CROSS PIN
17	REC650-45635-00	650-45635-00	ÉMBOLO	PLUNGER
18	PAF15-06070002	90501-14M06	MUELLE	SPRING
19	REC683-45611-00	683-45611-00	EJE HÉLICE	PROPELLER SHAFT
20	REC90201-17682	90201-17682	ARANDELA	WASHER
21	REC6E7-45570-00	6E7-45571-00	PIÑÓN MARCHA ATRÁS	REVERSE GEAR
22	PAF15-06080006-1	626-45577-00	GRUESO	SHIM
23	REC93306-00501	93306-00501	RODAMIENTO	BEARING (B6005)
24	REC93210-57M09	93210-57M09	TÓRICA	O-RING
25	PAF15-06080003	93210-56M80	TÓRICA	O-RING
26	REC683-45361-01-4D	683-45361-02-4D	DIÁBOLO	CAP, LOWER CASING
27	PAGB/T96-6	92995-06600	ARANDELA	WASHER
28	PAGB/T5783-M6X20	97095-06020	TORNILLO	SCREW
29	REC93315-317U2	93315-317U2	COJINETE	BEARING
30	REC93101-17054	93101-17054	RETÉN DE ACEITE	OIL SEAL
31	PAF15-06000015	6E7-45987-01	ESPACIADOR	SPACER
32	REC6E7-45987-00	6E7-45987-01	SEPARADOR	SPACER
33	REC90171-10M01	90171-10M01	TUERCA HÉLICE	NUT, CASTLE
34	REC91490-30025	91490-30020	PASADOR ALETAS	PIN, COTTER
35	PAF15-00000013	93604-10M03	PIN	PIN
36	PAF15-06030000S	63V-44150-00	EJE SELECTOR S	SHIFT CAM ASSY S
	PAF15-06030000L	63V-44150-10	EJE SELECTOR L	SHIFT CAM ASSY L
37	PAGB/T5783-M8X25	97080-08025	TORNILLO	SCREW
38	REC93210-06ME6	93210-06ME6	TÓRICA	O-RING
39	REC63V-45315-A0	63V-45315-A0	JUNTA	GASKET
40	REC93315-314V8	93315-314V8	COJINETE	BEARING
41	PAF15-06000006	63V-45536-00	TUBO GUÍA	SLEEVE, DRIVE SHAFT
42	REC63V-45331-00-5B	63V-45331-00-5B	CUERPO DEL COJINETE	SHELL, BEARING
43	PAF15-06020005	63V-45375-00	GOMA	SEAL
44	REC626-45316-09	90381-14020	CASQUILLO	BUSH, SOLID

	REF	OEM		
45	REC93101-20048	93101-20048	RETÉN DE ACEITE	OIL SEAL
46	REC63V-45510-01	63V-45510-01	EJE VERTICAL S	DRIVE SHAFT ASSY S
	REC63V-45510-11	63V-45510-11	EJE VERTICAL L	DRIVE SHAFT ASSY L
47	REC664-44338-00	63V-44338-00	CHAVETA	KEY, WOODRUFF
48	REC63V-44323-00	63V-44323-00	JUNTA TAPA BOMBA AGUA	GASKET, WATER PUMP COVER
49	PAJASOF404-31-045	93210-44398	ARO TÓRICO	O-RING
50	REC63V-44352-01	63V-44352-01	TURBINA	IMPELLER
51	REC63V-44301-00	63V-44301-00	CUERPO DE BOMBA	PUMP HOUSING
52	REC63V-44322-00	63V-44322-00	TAPA, BOMBA AGUA	COVER, INNER WATER PUMP
53	PAF15-00000013	93604-12M07	PASADOR	PIN
54	REC647-44366-00	647-44366-00	TUBO GOMA BOMBA AGUA	RUBBER TUBE, WATER PUMP
55	PAF15-06000014	63V-44328-00	PLACA	OUT PLATE
56	REC97080-08045	97080-08045	PERNO	STUD
57	REC63V-44361-01	63V-44361-01	TUBO DE AGUA S	WATER TUBE S
	REC63V-44361-11	63V-44361-11	TUBO DE AGUA L	WATER TUBE L
58	PAF15-02000006	63V-44365-10	GOMA DEL TUBO DE AGUA	I-SHAPED RUBBER BAND
59	REC61N-45251-01AL	61N-45251-01	ÁNODO	ÁNODE

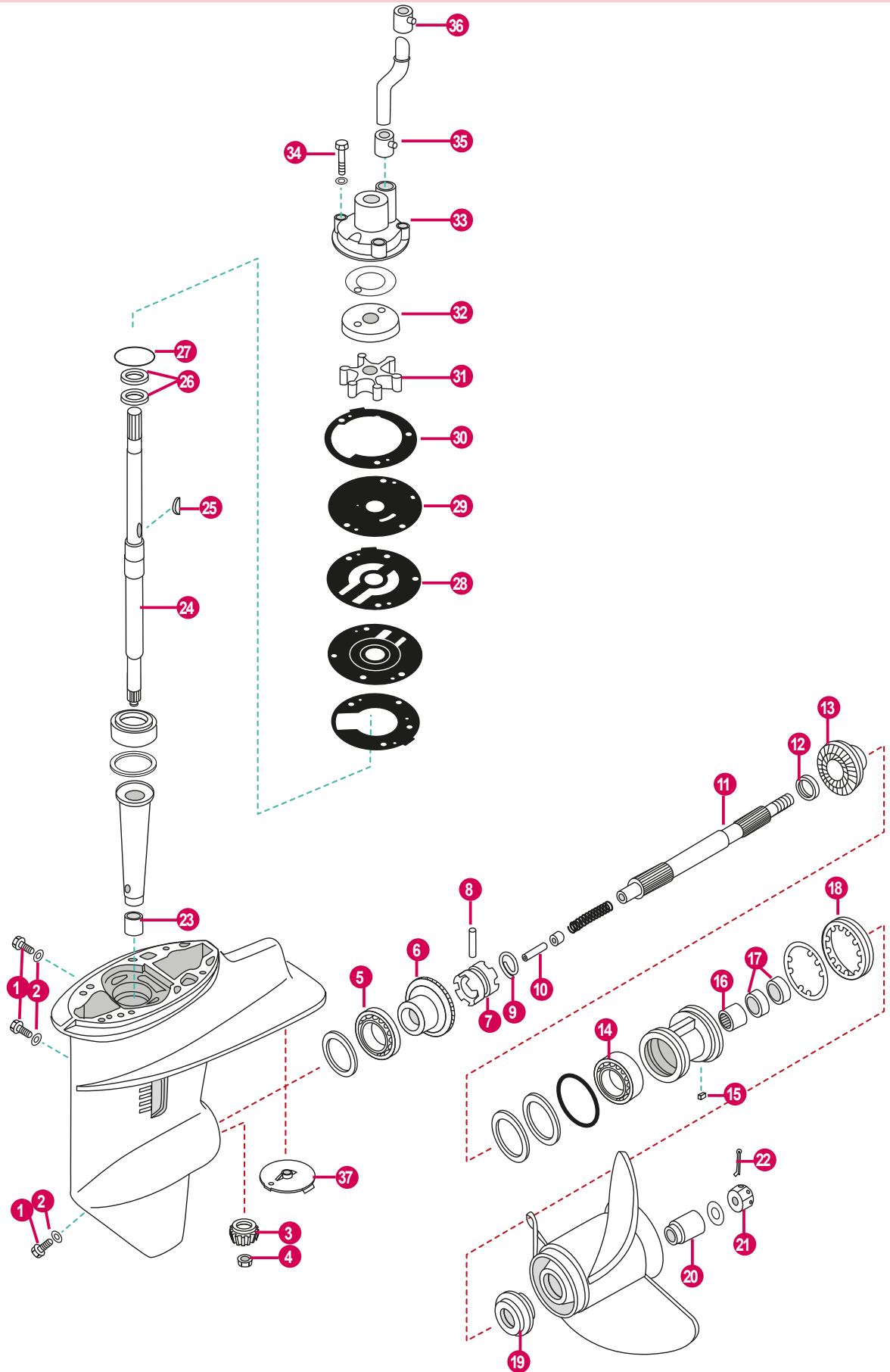

	REF	OEM		
1	REC90340-08002	90340-08002	TAPÓN ACEITE	PLUG, OIL
2	REC90430-08020	90430-08020	ARANDELA	WASHER
3	REC689-45551-00	689-45551-00	PIÑÓN ATAQUE	INITIATIVE GEAR
4	REC90179-09M02	90179-09M02	TUERCA, PIÑÓN	NUT
5	REC93332-00005	93332-00005	COJINETE	BEARING
6	REC689-45560-00	689-45560-00	PIÑÓN MARCHA AVANTE	POSITIVE GEAR ASSY
7	REC664-45631-01	664-45631-01	SELECTOR	CLUTCH
8	REC90250-05010	90250-05010	PASADOR	PIN
9	REC648-45633-00	648-45633-00	ARO, PASADOR	CROSS PIN
10	REC648-45635-00	648-45635-00	PIVOTE	PIN
11	REC689-45611-00	689-45611-00	EJE HÉLICE	SHAFT PROPELLER
12	REC90201-20417	90201-20417	ARANDELA	WASHER
13	REC689-45571-00-00	689-45570-00	PIÑÓN MARCHA ATRÁS	REVERSE GEAR
14	REC93306-00612	93306-00612	COJINETE	BEARING
15	REC90282-04010	90282-04010	CHAVETA	KEY
16	REC93315-22004	93315-22004	COJINETE	BEARING
17	REC93101-20M07	93101-20M07	RETÉN	OIL SEAL
18	REC664-45384-00	664-45384-00	TUERCA	NUT
19	REC664-45987-00	664-45987-00	ESPACIADOR	SPACER
20	REC689-45997-00	689-45997-00	ESPACIADOR	SAPCER
21	REC90171-14013-00	90171-14013	TUERCA HÉLICE	NUT
22	REC91490-30030	91490-30030	PASADOR	COTTER PIN
23	REC93315-017U4	93315-017U4	COJINETE, PIÑÓN	BEARING
24	REC689-45501-10	689-45501-10	EJE L	DRIVE SHAFT L
25	REC664-44338-00	664-44338-00	CUÑA	CHAVETA
26	REC93101-22067	93101-22067	RETÉN ACEITE	OIL SEAL
27	REC689-44315-A0	689-44315-A0	JUNTA BASE	GASKET
28	REC689-44316-A0	689-44316-A0	JUNTA BASE	GASKET
29	REC689-44323-00	689-44323-03	CHAPA	PLATE
30	REC689-44324-A0	689-44324-A0	JUNTA, CHAPA	GASKET
31	REC689-44352-02	689-44352-02	IMPULSOR	IMPELLER
32	REC689-W4432-01	689-W4432-02	ACOPLE	INSERT CUP
33	REC689-44311-00	689-44311-03	CUERPO BOMBA AGUA	HOUSING W.P.
34	REC90101-06M56	90101-06M56	TORNILLO CUERPO BOMBA	BOLT
35	REC626-44365-01	626-44365-01	RETÉN SUPERIOR TUBO DE AGUA	DUMPER WATER TUBE
36	REC689-44366-00	689-44366-00	RETÉN SUPERIOR TUBO DE AGUA	DUMPER WATER TUBE
37	REC664-45371-01AL	664-45371-01	ÁNODO	ÁNODO



REF	OEM
REC689-W0078-A6	689-W0078-A6

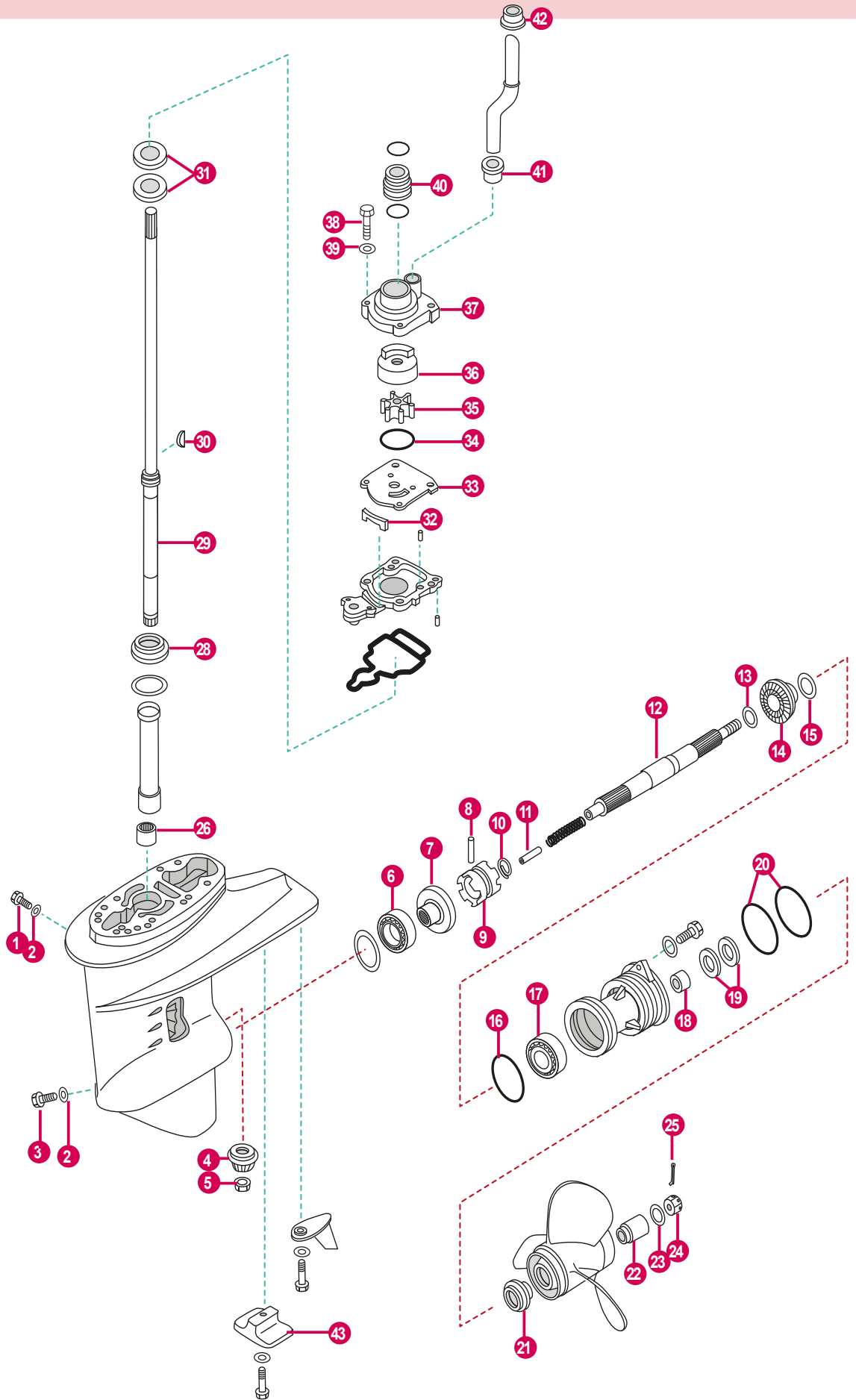

	REF	OEM		
1	REC90340-08002	90340-08002	TAPÓN	PLUG, STRAIGHT SCREW
2	REC90430-08020	90430-08020	JUNTA	GASKET
3	REC688-45341-00	688-45341-10	TAPÓN VACIADO	PLUG, DRAIN
4	REC61N-45551-00	61N-45551-00	PIÑÓN ATAQUE	INITIATIVE GEAR
5	REC90179-10M14	90179-10M14	TUERCA	NUT
6	REC93332-00005	93332-00005	RODAMIENTO	BEARING
7	REC61N-45560-10	61N-45560-10	PIÑÓN MARCHA AVANTE	POSITIVE GEAR ASSY
8	REC90250-05010	90250-05010	PASADOR	PIN, STRAIGHT
9	REC664-45631-00	664-45631-02	DEAPLAZABLE	CLUTCH, DOG
10	REC648-45633-00	648-45633-00	MUELLE	RING, CROSS PIN
11	REC648-45635-00	648-45635-00	BULÓN	PLUNGER, SHIFT
12	REC6L2-45611-00	6L2-45611-00	EJE HÉLICE	SHAFT, PROPELLER
13	REC90201-20417	90201-20417	ARANDELA	WASHER, PLATE
14	REC61N-45570-00	61N-45571-00	PIÑÓN MARCHA ATRÁS	REVERSE GEAR
15	PAF25-04070005-1	6L2-45577-00-10	GRUESO (1.0 mm)	SHIM (t:1.0mm)
16	REC93210-64ME7	93210-64ME7	ARO TÓRICO	O-RING
17	REC93306-00612	93306-00612	RODAMIENTO	BEARING
18	REC93315-22004	93315-22004	RODAMIENTO	BEARING
19	REC93101-20M07	93101-20M07	RETÉN	OIL SEAL
20	REC93210-65M50	93210-65M50	ARO TÓRICO	O-RING
21	REC6L2-45987-00	6L2-45987-01	SEPARADOR	SPACER
22	REC689-45997-00	689-45997-00	SEPARADOR	SPACER
23	PAGB/T97.1-14	92990-14200	ARANDELA	WASHER, PLAIN
24	REC90171-14013-00	90171-14013	TUERCA	NUT, CASTLE
25	PAGB/T91-1.6x12	91490-30022	PASADOR	PIN
26	REC93315-220V7	93315-220V7	RODAMIENTO	BEARING
28	REC93332-000W5	93332-000WS	RODAMIENTO	BEARING
29	REC61N-45510-00	61N-45510-00	EJE VERTICAL S	DRIVE SHAFT ASSY S
	REC61N-45510-10	61N-45510-10	EJE VERTICAL L	DRIVE SHAFT ASSY L
30	REC90280-03M03	90280-03M03	CHAVETA	KEY, WOODRUFF
31	REC93101-22067	93101-22067	RETÉN	OIL SEAL
32	PAF25-04000013	61N-45127-00	RETÉN	SEAL
33	REC61N-44323-00	61N-44323-00	PLATO BOMBA AGUA	OUTTER PLATE, CARTRIDGE
34	PAF25-04050003	93210-45161	ARO TÓRICO	O-RING
35	REC6H4-44352-02	6H4-44352-02	TURBINA	IMPELLER
36	REC61N-44322-00	61N-44322-01	CASQUILLO INOX.	INSERT, CARTRIDGE
37	PAF25-04050001	61N-44311-01	CUERPO BOMBA	HOUSING, WATER PUMP
38	REC97095-06040	97095-06040	TORNILLO	BOLT
39	PAGB/T96-6	92995-06600	ARANDELA	WASHER
40	PAF25-04000017S	61N-44362-00	TUBO AGUA S	WATER TUBE S
	PAF25-04000017	61N-44362-10	TUBO AGUA L	WATER TUBE L
41	REC6L2-44367-00	6L2-44367-00	CASQUILLO	DAMPER WATER PIPE
42	REC689-44366-00	689-44366-00	CASQUILLO	DAMPER, WATER SEAL
43	REC61N-45251-01AL	61N-45251-01	ÁNODO	ÁNODE



REF	OEM
REC61N-W0078-11	61N-W0078-11

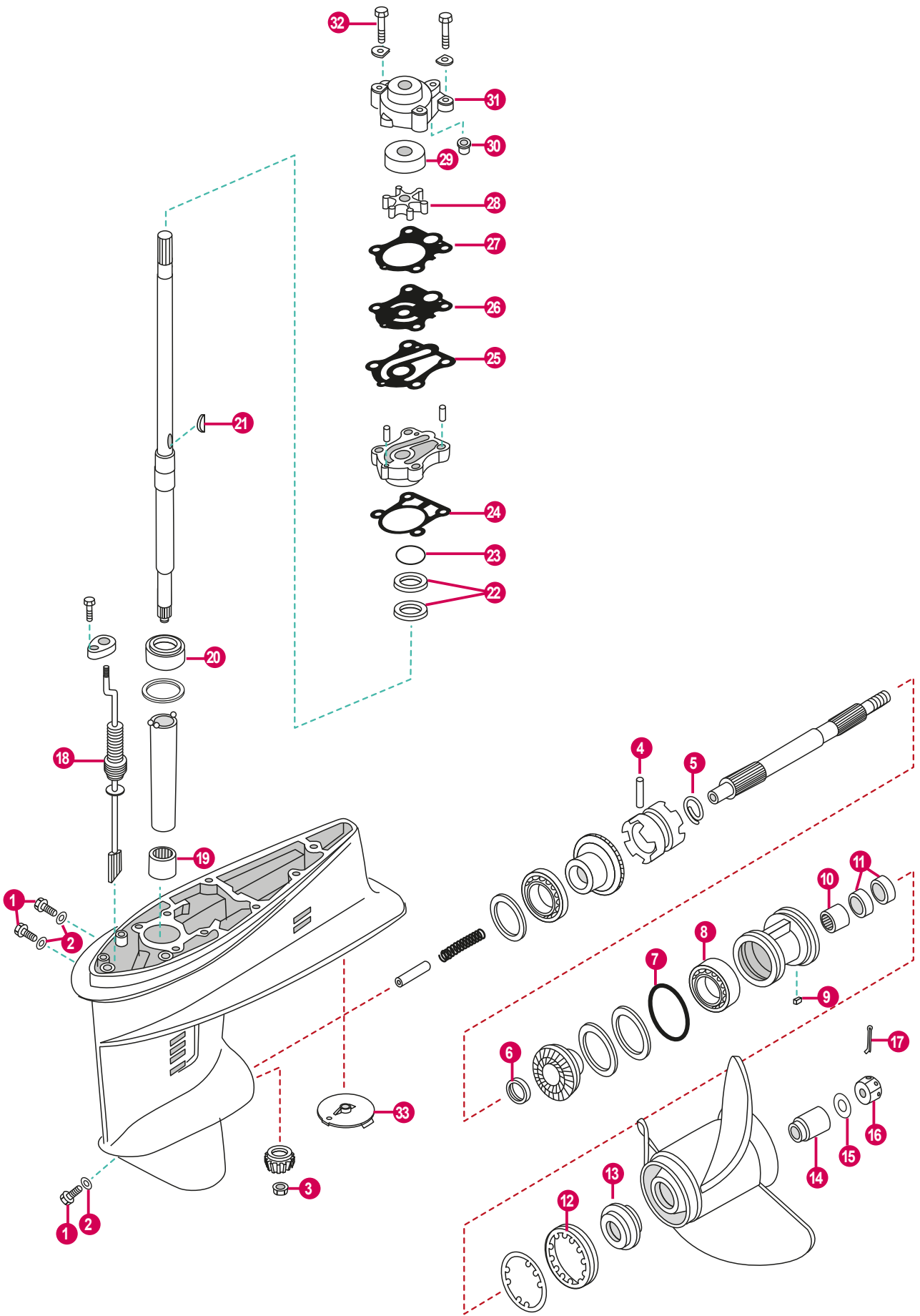

	REF	OEM		
1	REC90340-08002	90340-08002	TAPÓN	PLUG, STRAIGHT SCREW
2	REC90430-08020	90430-08020	JUNTA	GASKET
3	REC90179-10M14	90179-10M14	TUERCA	NUT
4	REC90250-05010	90250-05010	PASADOR	PIN, STRAIGHT
5	REC648-45633-00	648-45633-00	ARO	RING CROSS PIN
6	REC90201-20417	90201-20417	ARANDELA	WASHER, PLATE
7	REC93210-60MA3	93210-60MA3	ARO TÓRICO	O-RING
8	REC93306-00612	93306-00612	RODAMIENTO	BEARING
9	REC90282-04010	90282-04010	CHAVETA	KEY, STRAIGHT
10	REC93315-22004	93315-22004	RODAMIENTO	BEARING
11	REC93101-20M07	93101-20M07	RETÉN	OIL SEAL
12	REC664-45384-00	664-45384-00	TUERCA	NUT
13	REC6L2-45987-00	6L2-45987-01	DISTANCIADOR	SPACER
14	REC689-45997-00	689-45997-00	DISTANCIADOR	SPACER
15	PAGB/T97.1-14	92990-14200	ARANDELA	WASHER, PLAIN
16	REC90171-14013-00	90171-14013	TUERCA HÉLICE	NUT, CASTLE
17	REC91490-30025	91490-30025	PIN	PIN
18	REC682-44147-00	682-44147-00	TAPÓN GUÍA	BOOT, SHIFT ROD
19	REC93315-220V7	93315-220V7	RODAMIENTO	BEARING
20	REC93332-00001	93332-00001	RODAMIENTO	BEARING
21	REC90280-03024	90280-03024	CHAVETA	KEY, WOODRUFF
22	REC93101-23070	93101-23070	RETÉN	OIL SEAL
23	REC93210-41042	93210-41042	ARO TÓRICO	O-RING
24	REC663-44316-A0	663-44316-A0	JUNTA	GASKET, WATER PUMP
25	REC663-44324-00	663-44324-A0	JUNTA	GASKET, CARTRIDGE
26	REC663-44323-00	663-44323-00	PLATO BOMBA AGUA	OUTTER PLATE
27	REC663-44315-A0	663-44315-A0	JUNTA	GASKET, WATER PUMP
28	REC6H4-44352-02	6H4-44352-02	TURBINA	IMPELLER
29	REC663-44322-00	663-44322-00	CASQUILLO INOX	INSERT, CARTRIDGE
30	REC663-44366-00	663-44366-00	CASQUILLO GOMA	DAMPER, WATER SEAL
31	REC663-44311-02	6J8-44311-00	CUERPO BOMBA AGUA	HOUSING, WATER
32	REC90119-08M13	90119-08M13	TORNILLO	BOLT, WITH WASHER
33	REC664-45371-01AL	664-45371-01	ÁNODO	ÁNODO



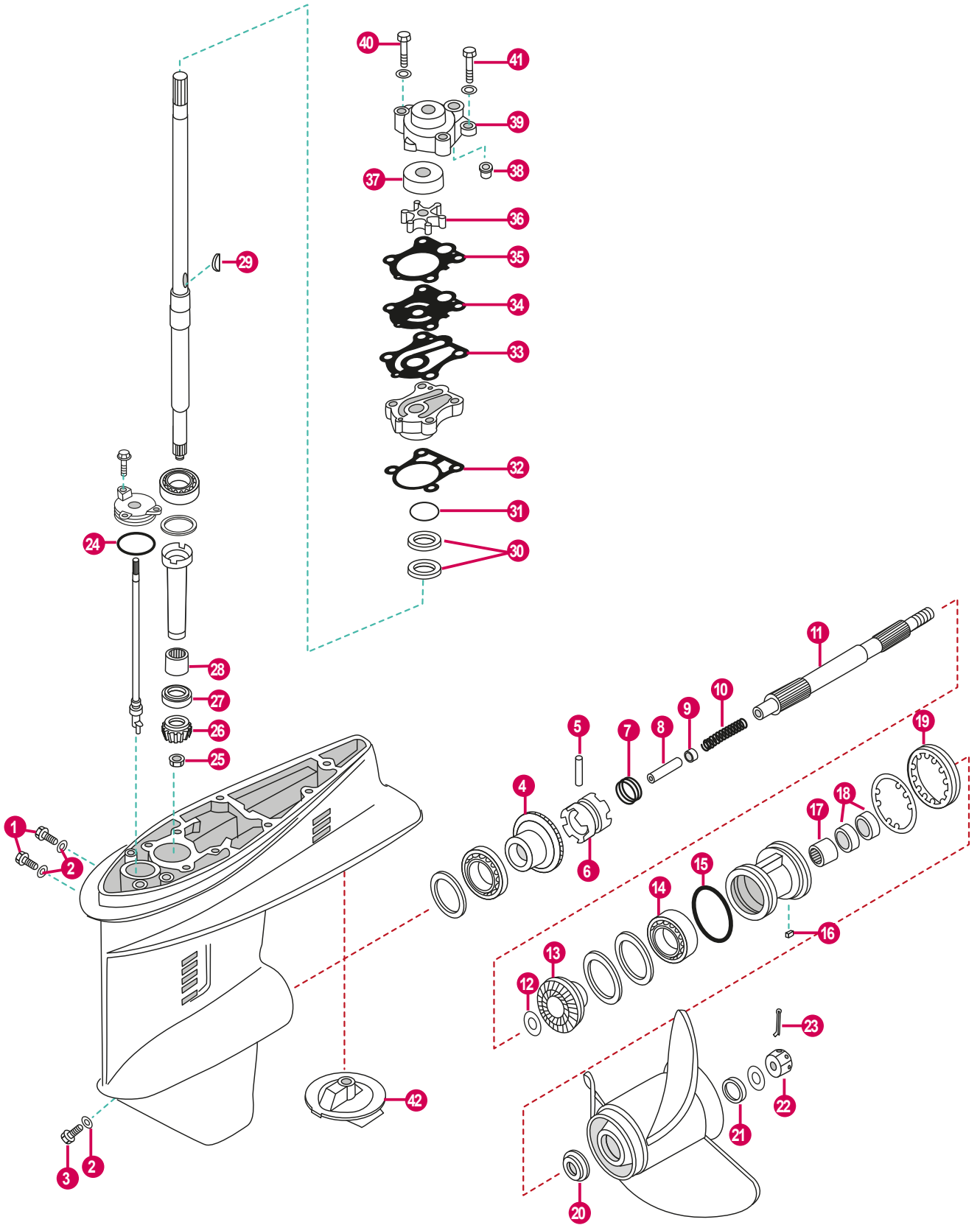

	REF	OEM		
1	REC90340-08002	90340-08014	TORNILLO	BOLT
2	REC90430-08020	90430-08020	JUNTA	GASKET
3	REC688-45341-00	688-45341-00	TAPÓN DRENAJE	PLUG
4	REC6H4-45560-00	6H4-45560-00	PIÑÓN MARCHA AVANTE	POSITIVE GEAR ASSY
5	REC90250-06023	90250-06023	PASADOR	PIN
6	REC663-45631-00	663-45631-01	DESPLAZABLE	CLUTCH
7	REC663-45633-00	663-45633-00	ARO	SPING
8	REC676-45635-00	676-45635-00	PIVOTE	PIN
9	REC663-45634-00	663-45634-00	CASQUILLO	SLIDE
10	REC90501-16M01	90501-16M01	MUELLE	SPRING
11	REC679-45611-00	679-45611-01	EJE HÉLICE	SHAFT PROPELLER
12	REC90201-22429	90201-22429	ARANDELA	WASHER
13	REC6H4-45570-00	6H4-45571-00	PIÑÓN MARCHA ATRÁS	REVERSE GEAR
14	REC93306-00702	93306-00702	RODAMIENTO BOLAS	BEARING
15	REC93210-66M98	93210-66M98	ARO	O-RING
16	REC90282-04010	90282-04010	CHAVETA	KEY
17	REC93317-22204	93317-22204	COJINETE AGUJAS	CILINDRIC BEARING
18	REC93101-22067	93101-22067	RETÉN ACEITE	OIL SEAL
19	REC697-45384-00	697-45384-00	TUERCA	NUT
20	REC663-45987-00	663-45987-02	ESPACIADOR	SPACER
21	REC670-45997-00	670-45997-02	ESPACIADOR	SPACER
22	REC90171-16011	90171-16011	TUERCA	NUT
23	REC91490-30030	91490-30030	PASADOR	PIN COTTER
24	REC93210-49046	93210-49046	ARO PLATO	O-RING
25	REC90170-12138	90170-12138	TUERCA	NUT
26	REC6H4-45551-00	6H4-45551-00	PIÑÓN ATAQUE	INITIATIVE GEAR
27	REC663-45552-00	663-45552-00	COJINETE (-1998)	BEARING (-1998)
28	REC93315-32224	93315-32224	RODAMIENTO AGUJAS	BEARING
29	REC90280-03024	90280-03024	CHAVETA	KEY
30	REC93101-23070	93101-23070	RETÉN ACEITE	OIL SEAL
31	REC93210-41042	93210-41042	ARO, BASE BOMBA	O-RING
32	REC663-44316-A0	663-44316-A0	JUNTA BASE	GASKET
33	REC663-44324-00	663-44324-A0	JUNTA	GASKET
34	REC663-44323-00	663-44323-00	TAPA	OUTTER PLATE
35	REC663-44315-A0	663-44315-A0	JUNTA	GASKET
36	REC6H4-44352-02	6H4-44352-02	IMPULSOR	IMPELLER
37	REC663-44322-00	663-44322-00	CASQUILLO	INSERT CARTRIDGE
38	REC663-44366-00	663-44366-00	RETÉN	SEAL
39	REC663-44311-02	663-44311-02	CUERPO BOMBA AGUA	HOUSING WATER P.
40	REC97095-08045	97395-08045	TORNILLO	BOLT
41	REC97095-08055	97395-08055	TORNILLO	BOLT
42	REC664-45371-01AL	664-45371-01	ÁNODO	ÁNODO

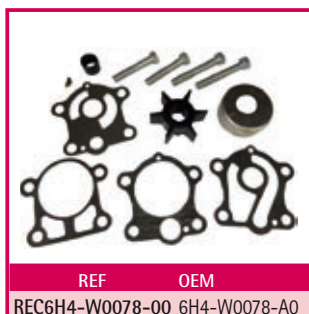

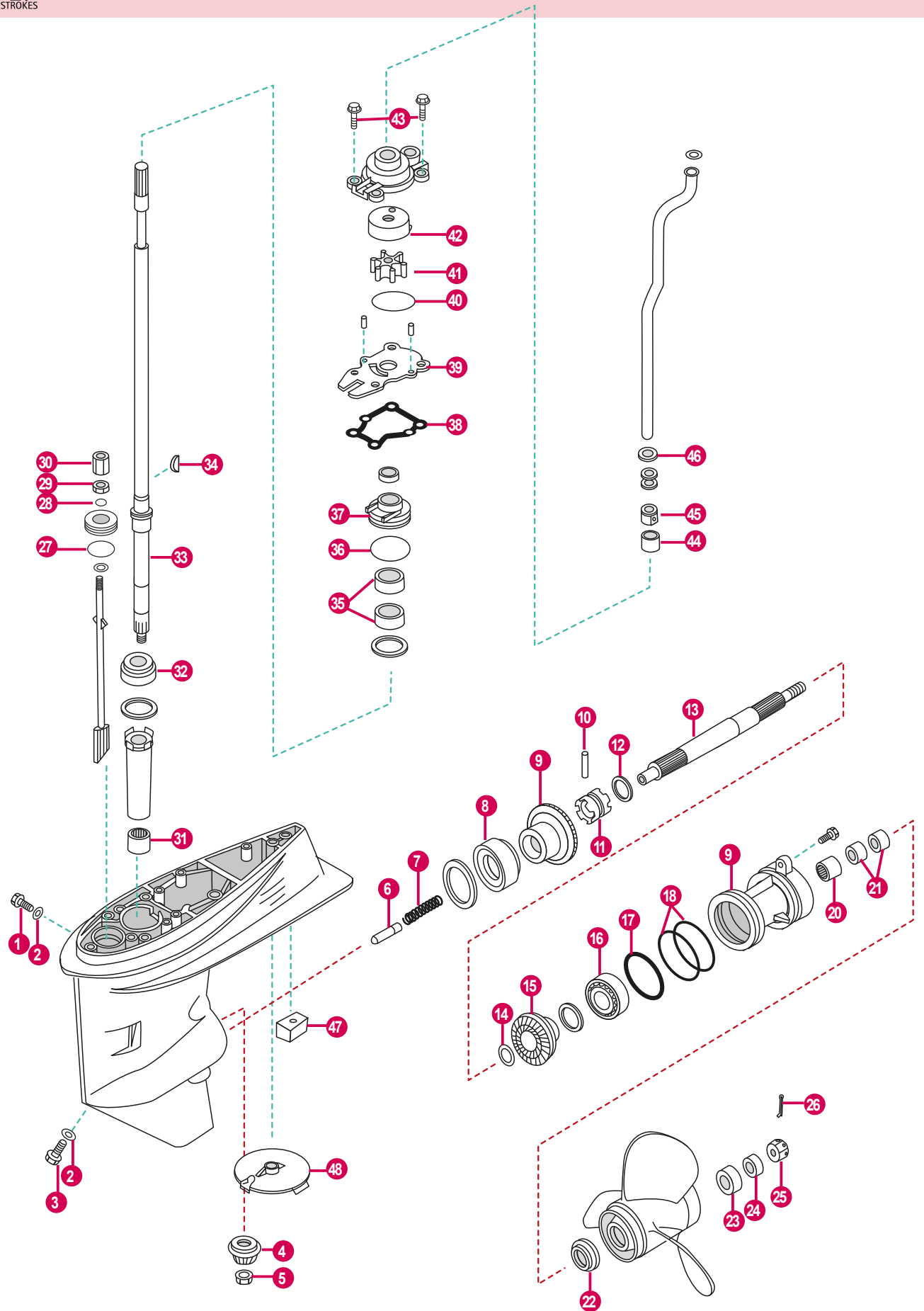

	REF	OEM		
1	REC90340-08002	90340-08002	TAPÓN	PLUG
2	REC90430-08020	90430-08020	JUNTA	GASKET
3	REC688-45341-00	688-45341-10	TAPÓN	PLUG
4	REC66T-45551-00	66T-45551-00	PIÑÓN ATAQUE	INITIATIVE GEAR
5	REC90170-12138	90170-12138	TUERCA	NUT
6	REC66T-45635-00	66T-45635-00	BULÓN	PLUNGER
7	PAT40-04050002	90501-15M01	RESORTE	SPRING
8	REC93332-00003	93332-00003	RODAMIENTO	BEARING
9	REC66T-45560-00	66T-45560-01	PIÑÓN MARCHA AVANTE	POSITIVE GEAR ASSY
10	REC90250-06023	90250-06023	PASADOR	PIN
11	REC66T-45631-00	66T-45631-00	SELECTOR	CLUTCH, DOG
12	REC663-45633-00	663-45633-00	ANILLO	RING
13	REC66T-45611-00	66T-45611-00	EJE HÉLICE	SHAFT
14	REC90201-22429	90201-22429	ARANDELA	WASHER
15	REC66T-45571-00	66T-45571-00	PIÑÓN MARCHA ATRÁS	REVERSE GEAR
16	REC93306-001U1	93306-001U1	RODAMIENTO	BEARING
17	REC93210-69MG6	93210-69MG6	ANILLO TÓRICO	O-RING
18	REC93210-74MG5	93210-74MG5	ANILLO TÓRICO	O-RING
19	REC63D-45361-02-4D	63D-45361-02-4D	DIÁVOLO	CAP
20	REC93317-22204	93317-22204	RODAMIENTO	BEARING
21	REC93101-22M00	93101-22M00	RETÉN	OIL SEAL
22	REC663-45987-00	663-45987-02	ESPACIADOR	SPACER
23	REC66T-45997-00	66T-45997-00	ESPACIADOR	SPACER
24	REC90389-22M01	90389-22M01	CASQUILLO GRUESO	BUSH
25	REC90171-16011	90171-16011	TUERCA HÉLICE	NUT, CASTLE
26	REC91490-30025	91490-30025	PASADOR ALETAS	PIN
27	REC93210-33MG4	93210-33MG4	ARILLO TÓRICO	O-RING
28	REC93210-06ME6	93210-06ME6	ARILLO TÓRICO	O-RING
29	REC95380-06700	95380-06700	TUERCA	NUT
30	REC61N-44146-00	61N-44146-00	CONECTOR	CONNECTOR
31	REC93315-32224	93315-32224	RODAMIENTO	BEARING
32	REC93332-00001	93332-00001	RODAMIENTO	BEARING
33	REC66T-45501-01	66T-45501-01	EJE VERTICAL S	DRIVE SHAFT ASSY S
	REC66T-45501-10	66T-45501-11	EJE VERTICAL L	DRIVE SHAFT ASSY L
34	REC90280-03M03	90280-03M03	CHAVETA	KEY
35	REC93101-22M60	93101-22M60	RETÉN	OIL SEAL
36	REC93210-48MG8	93210-48MG8	ARILLO TÓRICO	O-RING
37	REC63D-44341-00	63D-44341-00	CUERPO	HOUSING
38	REC63D-44316-00	63D-44316-00	JUNTA	GASKET, WATER PUMP
39	REC66T-44323-00	66T-44323-00	PLATO	OUTTER PLATE
40	REC93210-59MG7	93210-59MG7	ARILLO TÓRICO	O-RING
41	REC6H4-44352-02	6H4-44352-02	TURBINA	IMPELLER
42	REC63D-44322-00	63D-44322-00	CASQUILLO	INSERT
43	REC90119-08M15	90119-08M15	TORNILLO	BOLT
44	REC663-44366-00	663-44366-00	CASQUILLO	DAMPER
45	REC63D-44312-00	63D-44312-00	TAPA	COVER
46	REC90430-12072	90430-12072	JUNTA	GASKET
47	REC67C-45251-00AL	67C-45251-00	ÁNODO	ÁNODO
48	REC664-45371-01AL	664-45371-01	ÁNODO	ÁNODO



REF	OEM
REC66T-W0078-00	66T-W0078-00

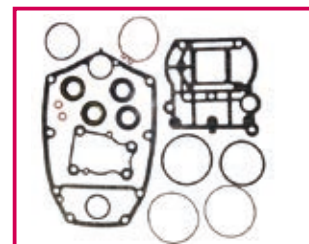

REF	OEM
REC66T-W0001-20	66T-W0001-20

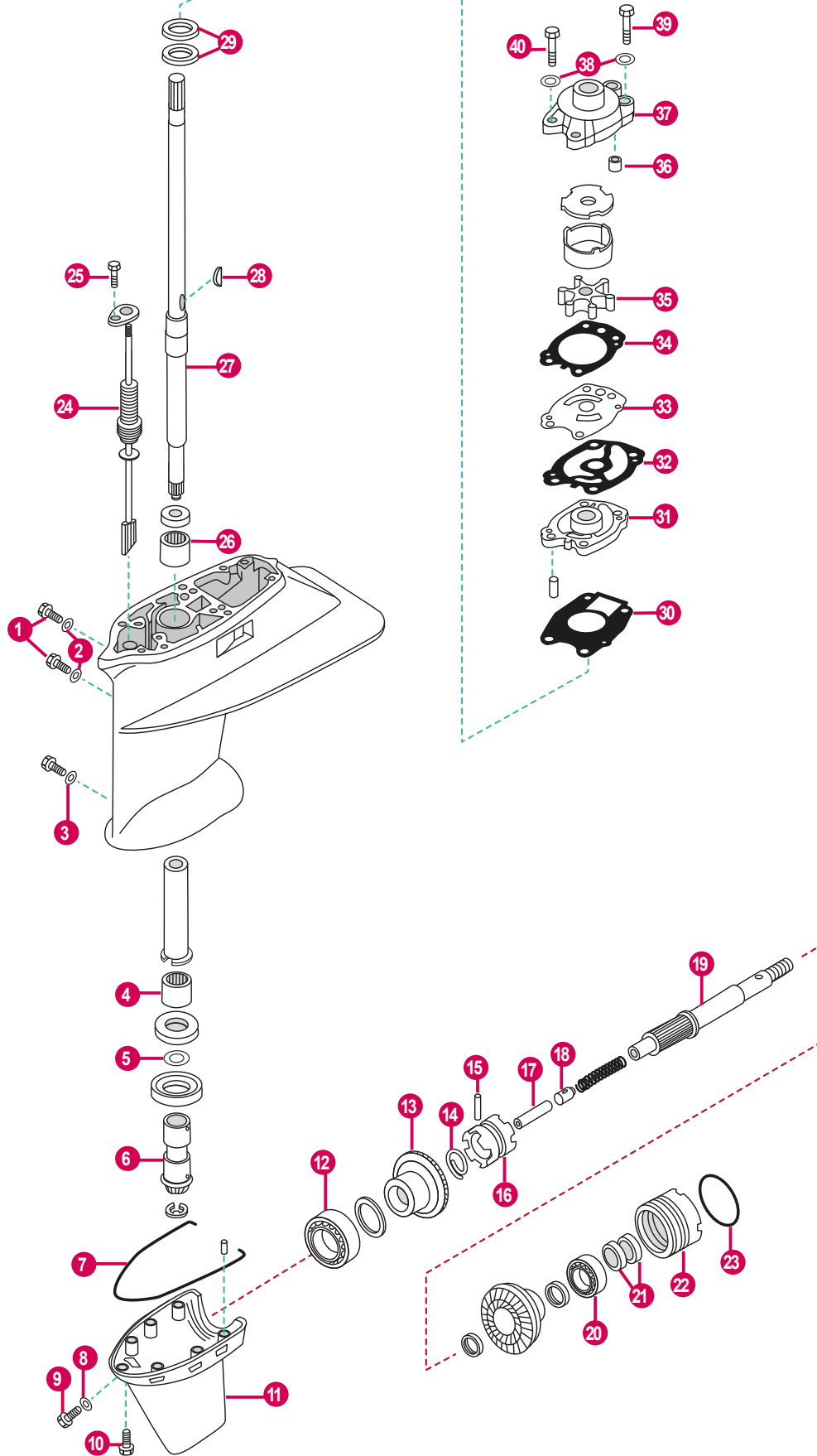

	REF	OEM		
1	REC90340-08002	90340-08002	TORNILLO, DRENAJE	BOLT DRAIN
2	REC90430-08020	90430-08020	JUNTA	GASKET
3	REC90430-06M03	90430-06M03	JUNTA	GASKET
4	REC93315-324U1	93315-324U1	COJINETE DE RODILLOS	BEARING
5	REC676-45587-00	676-45587-00-70	GRUESO	SHIM (t:0.070mm)
	REC676-45587-00-75	676-45587-00-75	GRUESO	SHIM (t:0.075mm)
	REC676-45587-00-80	676-45587-00-80	GRUESO	SHIM (t:0.080mm)
6	REC6F5-45551-00	6F5-45551-00	PIÑÓN	PINION (13T)
7	REC676-45314-00	676-45314-00	SELLO DE FUNDA INFERIOR	SEAL
8	REC90430-08020	90430-08020	JUNTA	GASKET
9	REC688-45341-00	688-45341-10	TAPÓN, DREN	BOLT DRAIN
10	REC90105-06M01	90105-06M01	TORNILLO	BOLT
11	REC6F5-45312-00-4D	6F5-45312-01-4D	FUNDA INFERIOR	CASING
12	REC93332-000U0	93332-000U0	COJINETE	BEARING
13	REC6F5-45560-00	6F5-45560-00	PIÑÓN MARCHA AVANTE	POSITIVE GEAR ASSY
14	REC663-45633-00	663-45633-00	ANILLO DE PASADOR	RING, CROSS PIN
15	REC90250-06023	90250-06023	PASADOR CILÍNDRICO	PIN, STRAIGHT
16	REC663-45631-00	663-45631-01	EMBRAGUE DE GARRA	CLUTCH DOG
17	REC676-45635-00	676-45635-00	ÉMBOLO DE CAMBIO	PLUNGER SHIFT
18	REC663-45634-00	663-45634-00	DESILIZADOR, CAMBIO	SLIDE SHIFT
19	REC6F6-45611-00	6F6-45611-00	EJE PROPULSOR	SHAFT PROPELLER
20	REC93306-204Y7	93306-20401	COJINETE (B6204)	BEARING
21	REC93101-20048	93101-20048	SELLO ACEITE	OIL SEAL
22	REC676-45361-00	676-45361-01-94	FUNDA INFERIOR	CAP LOWER CASING
23	REC93210-57M00	93210-57M00	ARO TÓRICO	O-RING
24	REC650-44147-00	650-44147-00	HULE DE VARILLA	BOOT, SHIFT ROD
25	PAGB/T5783-M6X10	97095-06010	PERNO	BOLT
26	REC93315-217U0	93315-217U0	COJINETE DE RODILLOS	BEARING
27	REC676-45501-10	676-45501-10	EJE DE MANDO COMPL	DRIVE SHAFT
28	REC90280-04M00	90280-04M00	CUNA WOODRUFF	KEY WOODRUFF
29	REC93101-22M00	93101-22M00	SELLO ACEITE	OIL SEAL
30	REC676-44316-A1	676-44316-A1	EMPAQUE	GASKET
31	REC676-44341-00	676-44341-94	CAJA BOMBA DE AGUA	HOUSING WATER PUMP
32	REC676-44324-A0	676-44324-A1	EMPAQUE	GASKET
33	REC676-44323-00-40	676-44323-40	PLACA EXTERIOR DEL CARTUCHO	PLATE
34	REC676-44315-00	676-44315-A1	EMPAQUE	GASKET
35	REC6F5-44352-00	6F5-44352-00	IMPULSOR	IMPELLER
36	REC663-44366-00	663-44366-00	GOMA DEL SELLO DE AGUA	DAMPER WATER SEAL
37	REC676-44311-00	676-44311-00	CAJA BOMBA AGUA	HOUSING WATER PUMP
38	PAGB/T97.1-8	92995-08600	ARANDELA	WASHER
39	REC97095-08055	97095-08055	PERNO	BOLT
40	REC97095-08045	97095-08045	PERNO	BOLT



REF	OEM
REC6F5-W0001-C0	6F5-W0001-C0



REF	OEM
REC679-W0078-A1	6F5-W0078-A0

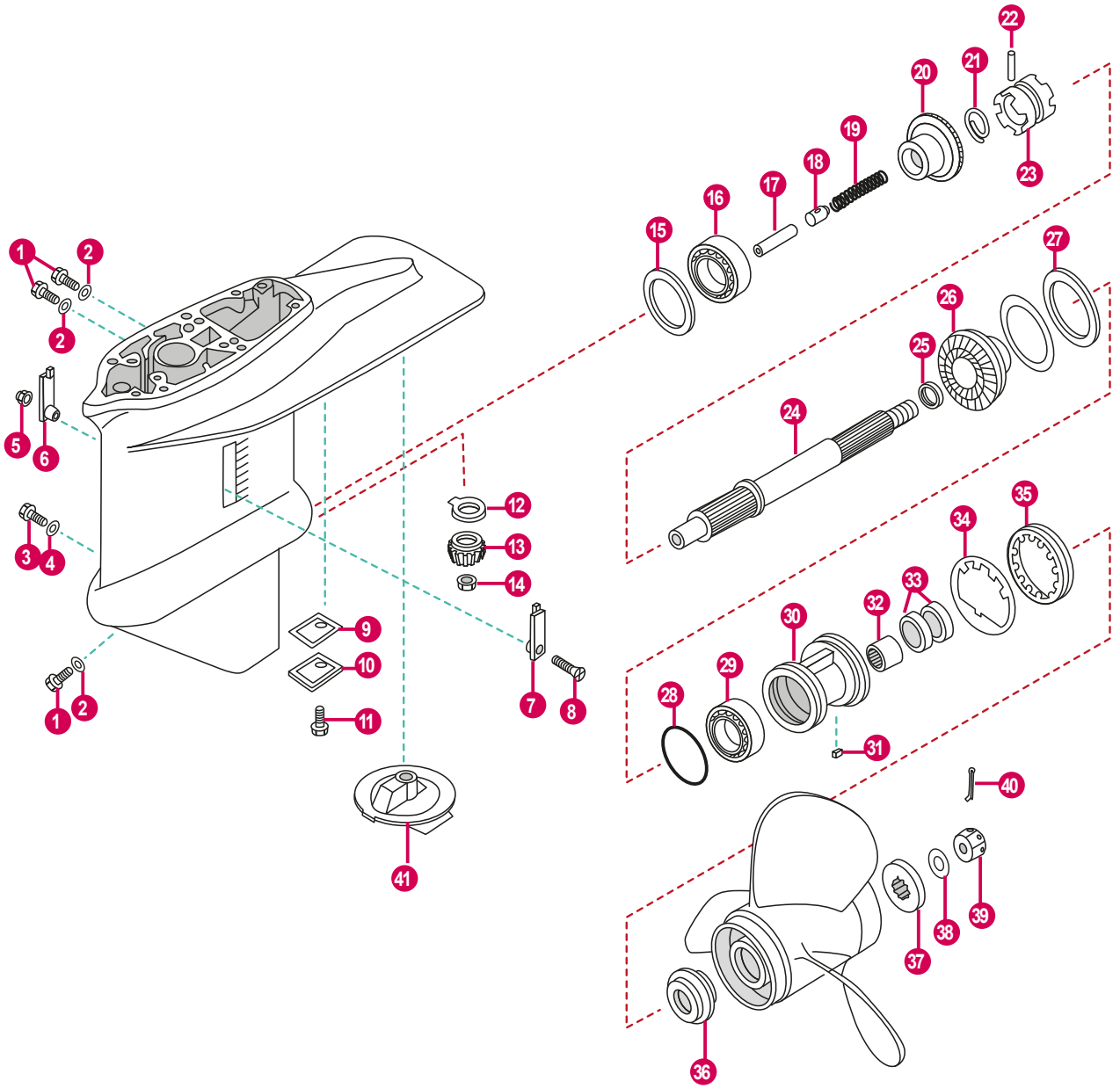

	REF	OEM		
1	REC90340-08002	90340-08M14	TORNILLO NIVEL ACEITE	VENT PLUG
2	REC90430-08020	90430-08020	ARANDELA	WASHER
3	REC90149-06M00	90149-06M00	TORNILLO DRENAJE	DRAIN SCREW
4	REC90430-06M03	90430-06M03	JUNTA	GASKET
5	PAGB/T889.1-M5		TUERCA	NUT
6	REC688-45215-02	688-45215-02	TAPA ENTRADA DE AGUA	WATER SCREEN
7	REC688-45214-02	688-45214-02	TAPA ENTRADA DE AGUA	WATER SCREEN
8	PAGB/T820-M5X30		TORNILLO	SCREW
9	REC679-45315-A1	679-45315-A1	JUNTA	GASKET
10	REC679-45321-02	679-45321-02	PLACA	PLATE
11	PAGB/T818-M6X16	98580-06016	TORNILLO	SCREW
12	REC663-45552-00	663-45552-00	COJINETE PLANO	BEARING
13	REC6H9-45551-00	6H9-45551-00	PIÑÓN ATAQUE	INITIATIVE GEAR
14	REC90170-12138	90170-012138	TUERCA	NUT
15	PAT40-04000004-1	663-45567-01-10	GRUESO (0.10mm)	SHIM (0.10mm)
	PAT40-04000004-5	663-45567-01-30	GRUESO (0.30mm)	SHIM (0.30mm)
16	REC93332-00003	93332-00003	COJINETE	BEARING
17	REC676-45635-00	676-45635-00	ÉMBOLO DE CAMBIO	PIVOT
18	REC663-45634-00	663-45634-00	DESLIZADOR DE CAMBIO	CLUTCH DOG
19	REC90501-16M01	90501-16M01	RESORTE DE COMPRESIÓN	SPRING
20	REC679-45560-00	679-45560-00	PIÑÓN MARCHA AVANTE	POSITIVE GEAR ASSY
21	REC663-45633-00	663-45633-00	ANILLO DEL PASADOR	ANNULAR SPRING, CLUTCH
22	REC90250-06023	90250-06023	PASADOR	PIN
23	REC663-45631-00	663-45631-01	EMBRAGUE DE GARRA	CLUCH DOG
24	REC679-45611-00	679-45611-01	EJE PROPULSOR	PROPELLER SHAFT
25	REC90201-22429	90201-22429	ARANDELA PLANA	WASHER
26	REC679-45571-00	679-45571-00	PIÑÓN MARCHA ATRÁS	REVERSE GEAR
27	REC663-45576-00	663-45576-00	ARANDELA DE EMPUJE	PUSH WASHER
28	REC93210-66M98	93210-66M98	O-RING	O-RING
29	REC93306-00702	93306-00702	COJINETE	BEARING
30	REC679-45331-00	679-45331-00-94	DIABOLO	DIABOLO
31	REC90282-04010	90282-04010	CHAVETA	KEY
32	REC93317-22204	93317-22204	COJINETE	BEARING
33	REC93101-22067	93101-22067	RETÉN DE ACEITE	SEAL OIL
34	REC90214-48M03	90214-48M03	ARANDELA	WASHER
35	REC697-45384-00	697-45384-00	TUERCA	NUT
36	REC663-45987-00	663-45987-00	ESPACIADOR	DISTANCE WASHER
37	REC66T-45997-00	66T-45997-00	ESPACIADOR	DISTANCE WASHER
38	REC90389-22M01	90389-22M01	ARANDELA	WASHER
39	REC90171-16011	90171-16011	TUERCA	NUT
40	REC91490-30025	91490-30025	CLIP	CLIP
41	REC679-45371-00AL	679-45371-00	ÁNODO	ÁNODO

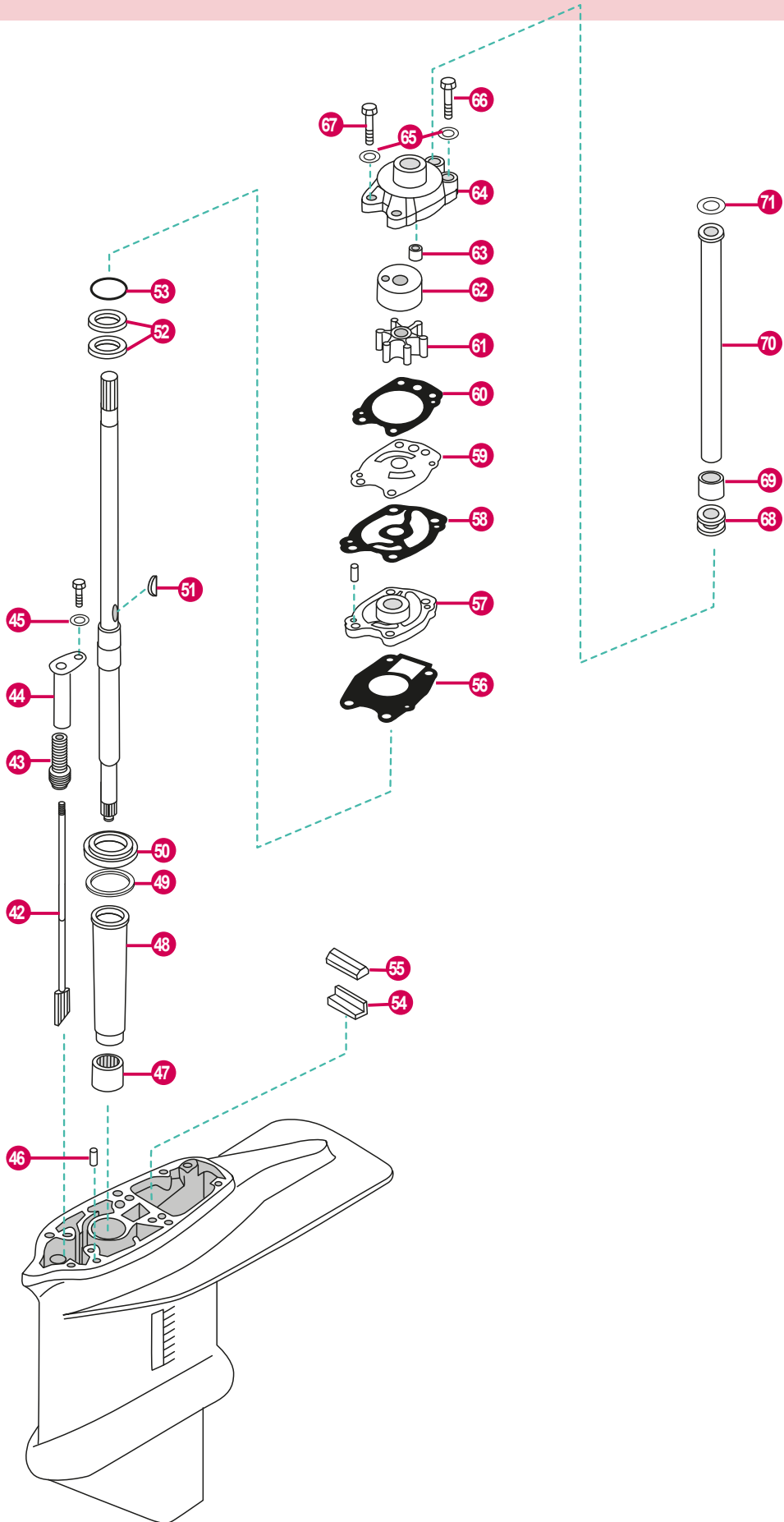

	REF	OEM		
42	REC679-44150-10	679-44150-10	EJE SELECTOR L	SHAFT SELECTOR L
	REC679-44150-00	679-44150-00	EJE SELECTOR S	SHAFT SELECTOR S
43	REC650-44147-00	650-44147-00	FUELLE EJE	BOOT, SHIFT ROD
44	REC679-44152-00	679-44152-00	BUJE LEVE DE CAMBIO	HUBE GEAR LEVE
45	PAGB/T96-6	92990-06600	ARANDELA PLANA	WASHER
46	REC93606-12019	93606-12019	PIN CENTRADOR	PIN DOWEL
47	REC93315-32224	93315-32224	COJINETE	BEARING
48	REC679-45536-00	679-45536-00	CAMISA EJE TRASMISION	BUSHING NYLON
	PAT40-04000003-1	663-45587-01-10	GRUESO (0.10mm)	SHIM (0.10mm)
	PAT40-04000003-2	663-45587-01-12	GRUESO (0.12mm)	SHIM (0.12mm)
49	PAT40-04000003-3	663-45587-01-15	GRUESO (0.15mm)	SHIM (0.15mm)
	PAT40-04000003-5	663-45587-01-30	GRUESO (0.30mm)	SHIM (0.30mm)
50	PAT40-04000027	93332-00079	COJINETE	BEARING
51	REC90280-04M00	90280-04M00	CHAVETA	KEY
52	REC93101-22067	93101-22067	RETÉN DE ACEITE	SEAL OIL
53	REC93210-41042	93210-41042	TÓRICA	O-RING
54	REC663-45376-00	663-45376-00	GUIA RETEN	GUIDE RUB. SEAL
55	REC663-45375-00	663-45375-00	GOMA SELLADORA	SEALING RUBBER
56	REC679-44316-A0	679-44316-A0	JUNTA	GASKET
57	REC679-44341-00	679-44341-00-94	CAJA BOMBA DE AGUA	WATER PUMP HOUSING
58	REC676-44324-A0	676-44324-A0	JUNTA	GASKET
59	REC676-44323-00-40	676-44323-00	PLACA EXTERIOR DEL CARTUCHO	OUTER PLATE
60	REC676-44315-00	676-44315-A0	JUNTA	GASKET
61	REC6F5-44352-00	6F5-44352-002	IMPULSOR	IMPELLER
62	REC676-44322-00	676-44322-00	CASQUILLO INOX	CARTRIDGE INSERT
63	REC663-44366-00	663-44366-00	RETEN TUBO AGUA	DAMPER, WATER SEAL
64	REC676-44311-00	676-44311-00	CAJA BOMBA DE AGUA	WATER PUMP HOUSING
65	PAGB/T97.1-8	92990-08600	ARANDELA PLANA	WASHER
66	REC97095-08055	97095-08055	PERNO	BOLT
67	REC97095-08045	97095-08045	PERNO	BOLT
68	PAT40-02000002	663-44367-00	GOMA DEL SELLO DE AGUA	GUIDE BUSHING, WATER PIPE
69	REC90430-12072	90430-12072	JUNTA	GASKET
70	REC676-44361-00	676-44361-00	TUBO S	TUBE S
	REC676-44361-10	676-44361-10	TUBO L	TUBE L
71	PAF25-02000019	90202-12060	GOMA DEL SELLO DE AGUA	GUIDE BUSHING, WATER PIPE

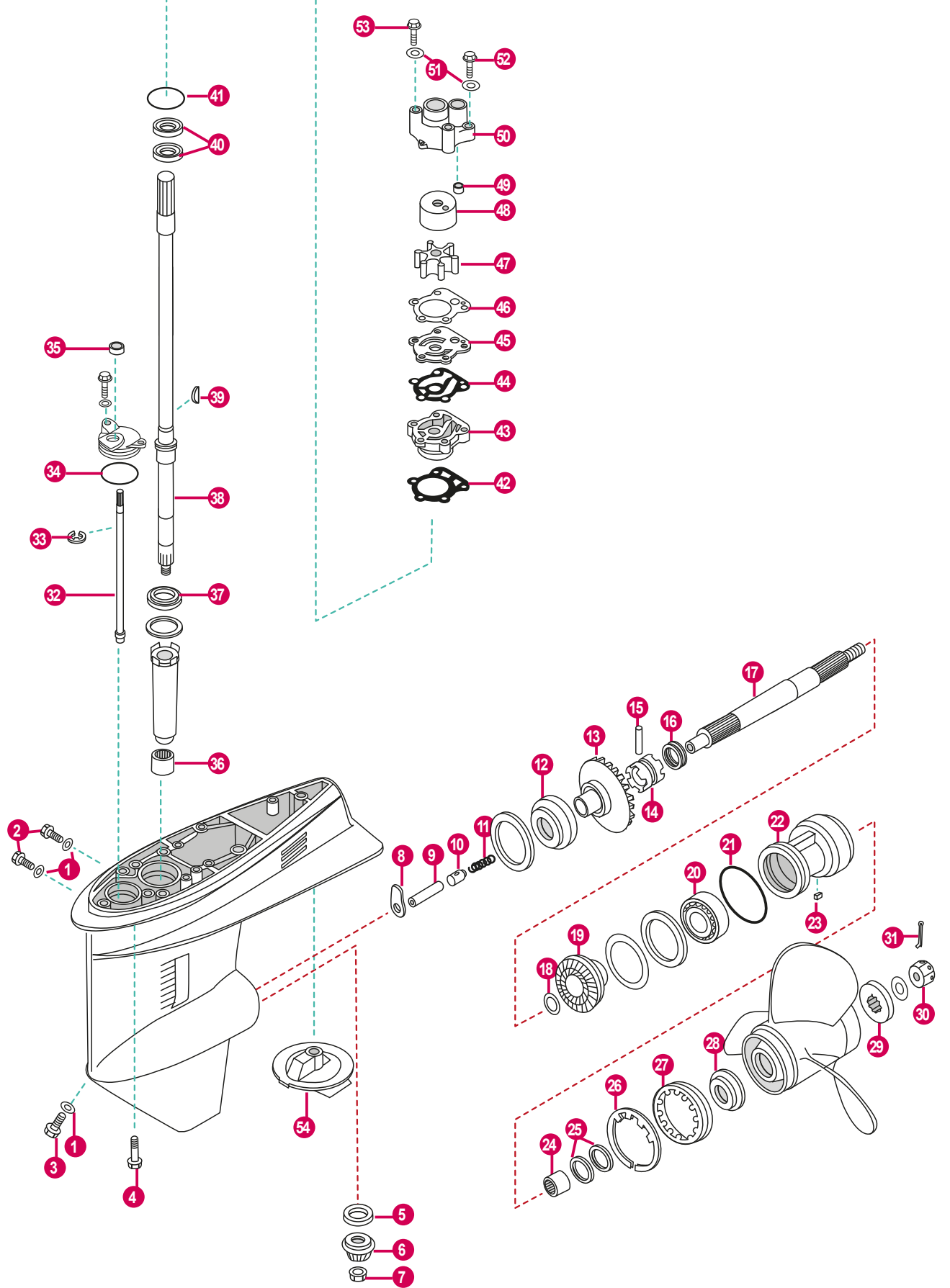

	REF	OEM		
1	REC90430-08020	90430-08020	JUNTA	GASKET
2	REC90340-08002	90340-08002	TORNILLO	STRAIGHT SCREW
3	REC688-45341-00	688-45341-10	TAPÓN, DREN	PLUG, DRAIN
4	REC97075-10040	97075-10040	PERNO	BOLT
5	REC663-45552-00	663-45552-00	COJINETE PLANO	BEARING, PLAIN
6	REC697-45551-00	697-45551-00	PIÑÓN ATAQUE	INITIATIVE GEAR
7	REC90170-12138	90170-12138	TUERCA	NUT
8	REC663-44151-00	663-44151-00	LEVA DE CAMBIO	CAM SHIFT
9	REC688-45635-00	688-45635-00	PLUNGER, SHIFT	ÉMBOLO DE CAMBIO
10	REC663-45634-00	663-45634-00	DESLIZADOR CAMBIO	SLIDE, SHIFT
11	REC90501-16233	90501-16233	RESORTE DE COMPRESIÓN	SPRING
12	REC93332-00003	93332-00003	COJINETE	BEARING
13	REC697-45560-00	697-45560-00	PIÑÓN MARCHA AVANTE	POSITIVE GEAR ASSY
14	REC663-45631-00	663-45631-01	EMBRAGUE DE GARRA	CLUTCH, DOG
15	REC90250-06023	90250-06023	PASADOR CILÍNDRICO	PIN, STRAIGHT
16	REC663-45633-00	663-45633-00	ANILLO DE PASADOR	RING, CROSS PIN
17	REC697-45611-00	697-45611-00	EJE PROPULSOR	SHAFT PROPELLER
18	REC90201-22429	90201-22429	ARANDELA PLANA	WASHER, PLATE
19	REC697-45570-00	697-45571-00	PIÑÓN MARCHA ATRÁS	REVERSE GEAR
20	REC93306-00702	93306-00702	COJINETE	BEARING
21	REC93210-66M98	93210-66M98	ANILLO O	O- RING
22	REC663-45331-00-94	663-45331-00-94	CAJA DE COJINETE	HOUSING, BEARING
23	REC90282-04010	90282-04010	CHAVETA	KEY, STRAIGHT
24	REC93317-22204	93317-22204	COJINETE	BEARING
25	REC93101-22067	93101-22067	SELLO ACEITE	OIL SEAL
26	REC90214-48M03	90214-48M03	ARANDELA	WASHER
27	REC697-45384-00	697-45384-00	TUERCA	NUT
28	REC663-45987-00	663-45987-02	ESPACIADOR	SPACER
29	REC670-45997-00	670-45997-02	ESPACIADOR	SPACER
30	REC90171-16011	90171-16011	TUERCA ENTALLADA	NUT, CASTLE
31	REC91490-30025	91490-40025	CHAVETA	PIN, COTTER
32	REC663-44144-01	663-44144-01	VARILLA DE CAMBIO	ROD, SHIFT
33	REC99001-08600-00	99001-08600	CLIP	CLIP
34	REC93210-49046	93210-49046	ANILLO	O-RING
35	REC93106-09014	93106-09014	RETÉN DE ACEITE	OIL SEAL
36	REC93315-32224	93315-32224	COJINETE DE RODILLOS	BEARING
37	REC93332-00001	93332-00001	COJINETE	BEARING
38	REC663-45510-01	663-45510-01	EJE DE MANDO	DRIVE SHAFT ASSY
39	REC90280-03M03	90280-03M03	CHAVETA	KEY, WOODRUFF
40	REC93101-23070	93101-23070	SELLO ACEITE	OIL SEAL
41	REC93210-41042	93210-41042	ANILLO O	O-RING
42	REC663-44316-A0	663-44316-A0	EMPAQUE	GASKET, WATER PUMP
43	REC663-44311-02	663-44341-00	CAJA BOMBA	HOUSING, WATER PUMP
44	REC663-44324-00	663-44324-A0	EMPAQUE	GASKET, CARTRIDGE
45	REC663-44323-00	663-44323-00	PLACA EXTERIOR	OUTTER PLATE
46	REC663-44315-A0	663-44315-A0	EMAPAQUE	GASKET, WATER PUMP
47	REC6H3-44352-00	697-44352-00	IMPULSOR	IMPELLER
48	REC663-44322-00	663-44322-00	CARTUCHO	INSERT CARTRIDGE
49	REC663-44366-00	663-44366-00	GOMA SELLO	DAMPER, WATER SEAL
50	REC663-44311-02	663-44311-02	CAJA BOMBA	HOUSING, WATER PUMP
51	PAGB/T97.1-8	92995-08600	ARANDELA	WASHER
52	REC97095-08045	97095-08045	PERNO	BOLT
53	REC97095-08055	97095-08055	PERNO	BOLT
54	REC679-45371-00AL	679-45371-00	ÁNODO	ÁNODE



REF	OEM
REC663-W0078-01	663-W0078-00 663-W0078-01

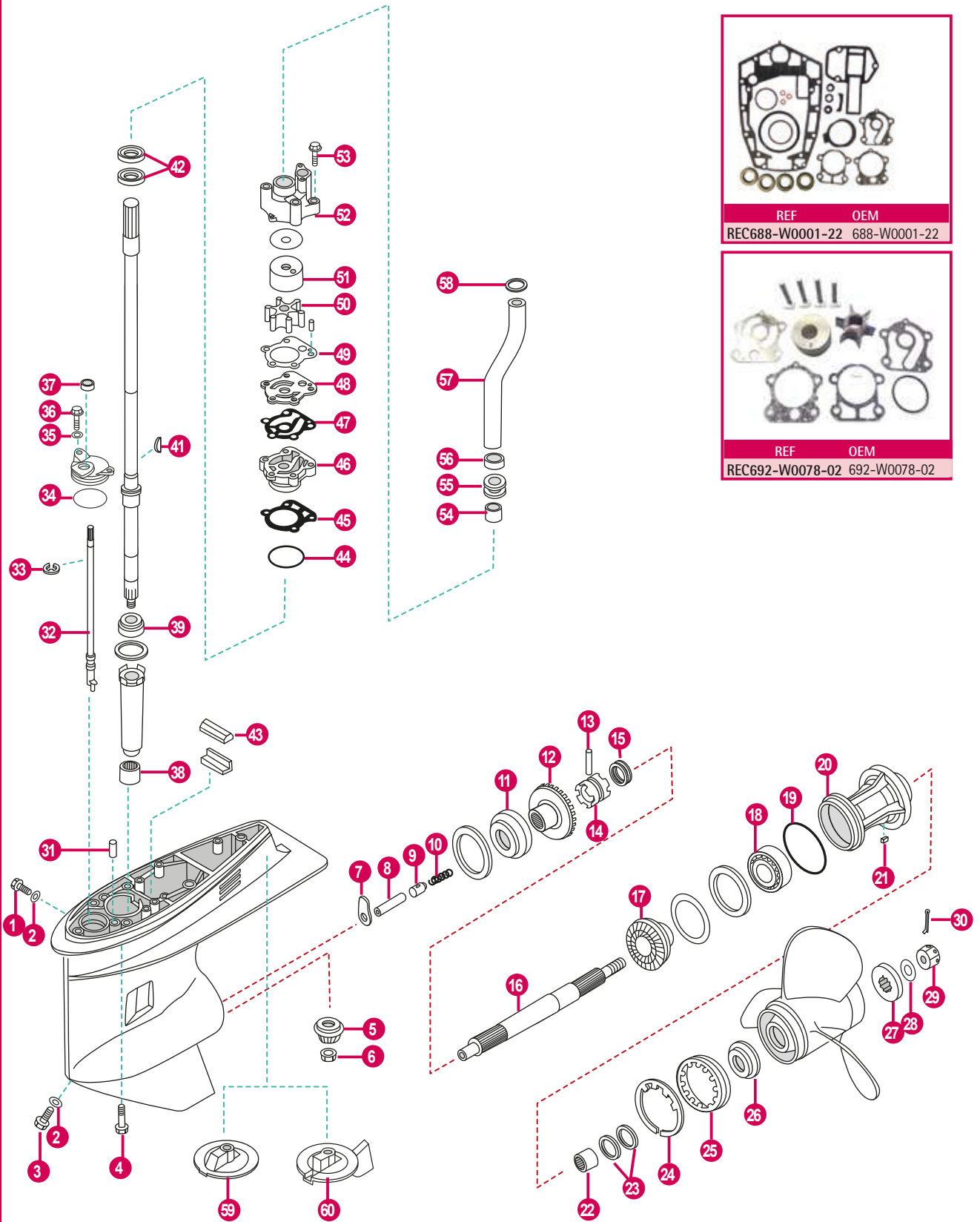

	REF	OEM		
	REC692-45300-16-8D	692-45300-14-4D	COLA COMPLETA L	LOWER UNIT ASSY L
1	REC90340-08002	90340-08002	TAPÓN	PLUG STRAIGHT SCREW
2	REC90430-08020	90430-08020	JUNTA	GASKET
3	REC688-45341-00	688-45341-10	TAPÓN	PLUG DRAIN
4	REC97075-10040	97075-10040	TORNILLO	BOLT WITH WASHER
5	REC688-45551-00	688-45551-01	PIÑÓN ATAQUE	INITIATIVE GEAR
6	REC90170-16M01	90170-16M01	TUERCA	NUT
7	REC663-44151-00	663-44151-00	LEVA	CAM, SHIFT
8	REC688-45635-00	688-45635-00	BULÓN	PLUNGER, SHIFT
9	REC688-45634-00	688-45634-00	EMPUJADOR	SLIDE, SHIFT
10	REC90501-16233	90501-16233	MUELLE	SPRING COMPRESSION
11	REC93332-000W7	93332-000W7	RODAMIENTO	BEARING
12	REC688-45560-00	688-45560-00	PIÑÓN MARCHA AVANTE	POSITIVE GEAR ASSY
13	REC90250-07M02	90250-07M02	PASADOR	PIN, STRAIGHT
14	REC688-45631-00	688-45631-01	DESPLAZABLE	CLUTCH, DOG
15	REC688-45633-00	688-45633-00	ARO METÁLICO	RING, CROSS PIN
16	REC688-45611-00	688-45611-00	EJE HÉLICE	SHAFT, PROPELLER
17	REC688-45570-00	688-45571-01	PIÑÓN MARCHA ATRAS	REVERSE GEAR
18	REC93306-207U0	93306-207U0	RODAMIENTO	BEARING
19	REC93210-85M97	93210-85M97	ARO TÓRICO	O-RING
20	REC688-45331-00-94	688-45331-00-94	DIÁBOLO	HOUSING, BEARING
21	REC90282-04010	90282-04010	CHAVETA	KEY, STRAIGHT
22	REC93317-325U0	93317-325U0	RODAMIENTO	BEARING
23	REC93101-25M03	93101-25M03	RETÉN	OIL SEAL
24	REC688-45383-01	688-45383-02	ARANDELA CIERRE	WASHER, CLAW
25	REC688-45384-00	688-45384-00	TUERCA	NUT
26	REC688-45987-00	688-45987-01	SEPARADOR	SPACER
27	REC67F-45997-00	67F-45997-00	SEPARADOR	SPACER
28	REC90389-25M00	90389-25M00	CASQUILLO	BUSH
29	REC90171-16011	90171-16011	TUERCA	NUT, CASTLE
30	REC91490-30025	91490-40025	PASADOR ALETAS	PIN, COTTER
31	REC93606-12019	93606-12019	PASADOR	PIN, DOWEL
32	REC663-44144-01	663-44144-01	EJE SELECTOR	ROD, SHIFT
33	REC99001-08600-00	99001-08600	CERCLIP	CIRCLIP
34	REC93210-49046	93210-49046	ARO TÓRICO	O-RING
35	PAGB/T5783-M6X16	92995-06600	ARANDELA	WASHER
36	PAGB/T96-6	97095-06016	TORNILLO	BOLT
37	REC93106-09014	93106-09014	RETÉN	OIL SEAL
38	REC93315-325V1	93315-325V1	RODAMIENTO	BEARING
39	REC93332-000U3	93332-000U3	RODAMIENTO	BEARING
41	REC90280-04M04	90280-04M04	CHAVETA	KEY, WOODRUFF
42	REC93101-25M03	93101-25M03	RETÉN	OIL SEAL
43	REC688-45375-00	688-45375-00	RETÉN DAMPER	DAMPER WASHER
44	REC93210-46044	93210-46044	ARO TÓRICO	O-RING
45	REC688-44316-00	688-44316-A0	JUNTA	GASKET WATER PUMP
46	REC688-44341-01	688-44341-01-94	TAPA INF. BOMBA AGUA	HOUSING, WATER PUMP

	REF	OEM		
47	REC688-44324-00	688-44324-A0	JUNTA	GASKET, CARTRIDGE
48	REC688-44323-00	688-44323-40	PLATO	OUTTER PLATE, CARTRIDGE
49	REC688-44315-00	688-44315-A0	JUNTA	GASKET, WATER PUMP
50	REC688-44352-03	688-44352-03	TURBINA	IMPELLER
51	REC688-44322-00	688-44322-00	CASQUILLO INOX.	INSERT, CARTRIDGE
52	REC688-44311-01	688-44311-01	CUERPO BOMBA AGUA	HOUSING, WATER PUMP
53	REC90119-08M13	90119-08M13	TORNILLO	BOLT WITH WASHER
54	REC663-44366-00	663-44366-00	CASQUILLO GOMA	DAMPER, WATER SEAL
55	PAT40-02000002	663-44367-00	GOMA DEL SELLO DE AGUA	GUIDE BUSHING, WATER PIPE
56	REC90430-12072	90430-12072	JUNTA	GASKET
57	REC688-44361-10	688-44361-10	TUBO DE AGUA L	WATER TUBE L
58	PAF25-02000019	90202-12060	ARANDELA	WASHER
59	REC6E5-45371-01AL	6E5-45371-01	ÁNODO	ÁNODE
60	REC67F-45371-00AL	67F-45371-00	ÁNODO	ÁNODE

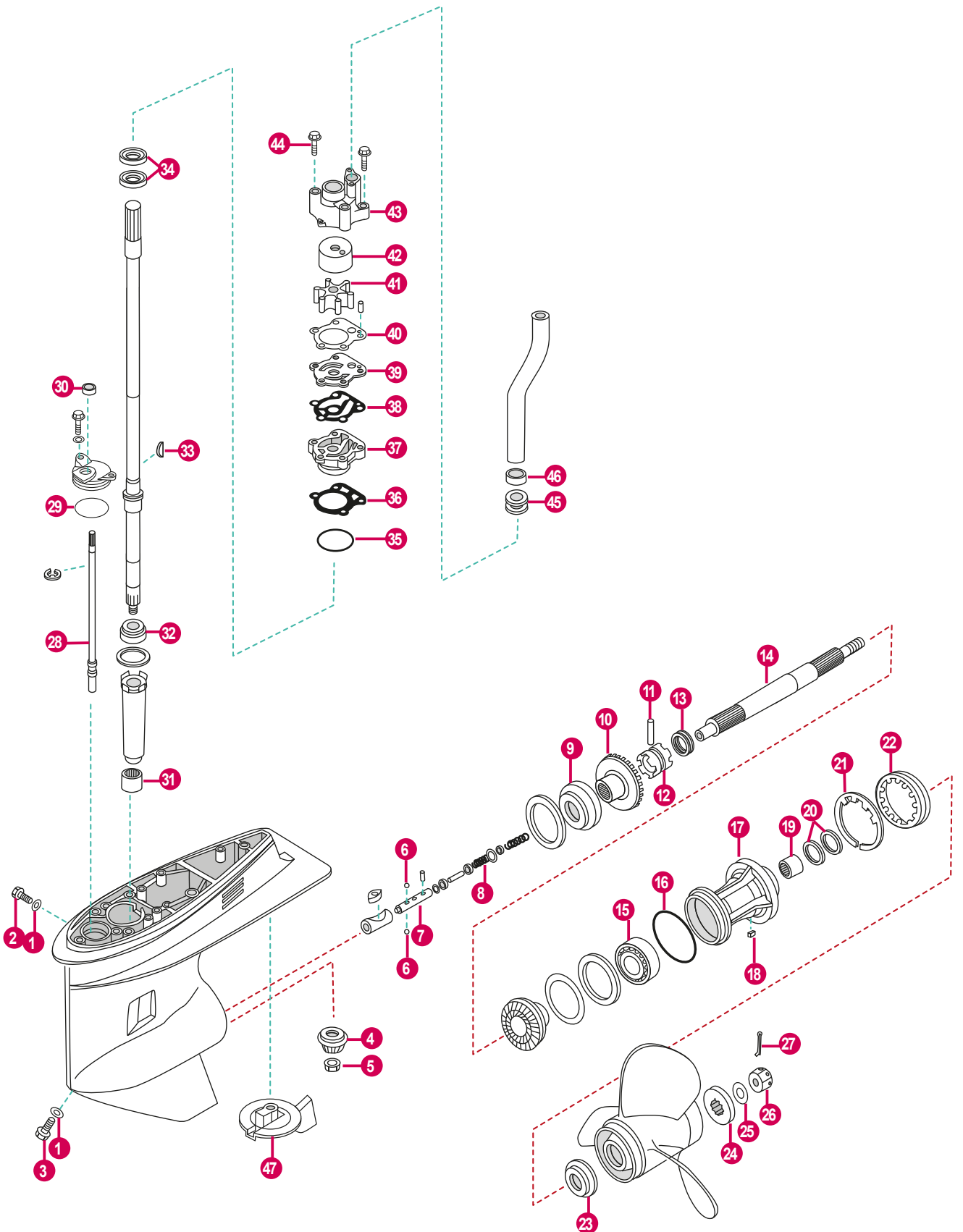

	REF	OEM		
1	REC90430-08020	90430-08020-00	JUNTA	GASKET
2	REC90340-08002	90340-08002	TAPÓN	PLUG
3	REC688-45341-00	688-45341-00-00	TAPÓN	PLUG
4	REC688-45551-00	688-45551-01-00	PIÑÓN ATAQUE	INITIATIVE GEAR
5	REC90170-16M01	90170-16M01-00	TUERCA	NUT
6	REC93503-16003	93503-16003	ESFERA	BALL
7	REC6H1-45634-02	6H1-45634-02	DESPLAZABLE	SLIDE, SHIFT
8	REC90501-12M48	90501-12M48	RESORTE	SPRING
9	REC93332-000W7	93332-000W7-00	RODAMIENTO	BEARING
10	REC688-45560-00	688-45560-00-00	PIÑÓN MARCHA AVANTE	POSITIVE GEAR ASSY
11	REC90250-07M02	90250-07M02-00	PASADOR	PIN
12	REC6H1-45631-01	6H1-45631-01-00	SELECTOR	CLUTCH
13	REC688-45633-00	688-45633-00-00	MUELLE	SPRING
14	REC6H1-45611-00	6H1-45611-01-00	EJE HÉLICE	PROPELLER SHAFT
15	REC93306-207U0	93306-207U0-00	RODAMIENTO	BEARING
16	REC93210-85M97	93210-85M97-00	ARO TÓRICO	O-RING
17	REC688-45331-00-94	688-45331-00-94	DIABOLO	DIABOLO
18	REC90282-04010	90282-04010	CHAVETA	KEY
19	REC93317-325U0	93317-325U0-00	RODAMIENTO	BEARING
20	REC93101-25M03	93101-25M03-00	RETÉN	OIL SEAL
21	REC688-45383-01	688-45383-02-00	ARANDELA	WASHER
22	REC688-45384-00	688-45384-00-00	TUERCA	NUT
23	REC688-45987-00	688-45987-01-00	ESPACIADOR	SPACER
24	REC688-45997-00	688-45997-01-00	ESPACIADOR	SPACER
25	REC90201-17M00	90201-17M00-00	ARANDELA	WASHER
26	REC90171-16011	90171-16011-00	TUERCA	NUT
27	REC91490-30025	91490-40030-00	PASADOR	PIN
28	REC6H1-44144-00	6H1-44144-00	VARILLA CAMBIO	SHIFT ROD
29	REC93210-49046	93210-49046-00	ANILLO	O-RING
30	REC93106-09014	93106-09014-00	RETÉN	OIL SEAL
31	REC93315-325V1	93315-325V1-00	RODAMIENTO	BEARING
32	REC93332-000U3	93332-000U3-00	RODAMIENTO	BEARING
33	REC90280-04M04	90280-04M04-00	CHAVETA	KEY
34	REC93101-25M03	93101-25M03-00	RETÉN	OIL SEAL
35	REC93210-46044	93210-46044-00	ANILLO, BASE	O-RING
36	REC688-44316-00	688-44316-A0-00	JUNTA, BASE	GASKET
37	REC688-44341-01	688-44341-01-94	BASE, BOMBA AGUA	HOUSING WATER PUMP
38	REC688-44324-00	688-44324-A0-00	JUNTA	GASKET
39	REC688-44323-00	688-44323-00-00	PLATO	PLATE
40	REC688-44315-00	688-44315-A0-00	JUNTA	GASKET
41	REC688-44352-03	688-44352-03-00	TURBINA	IMPELLER
42	REC688-44322-00	688-44322-00-00	ACOPLAMIENTO INOX.	INSERT
43	REC688-44311-01	688-44311-01-00	CUERPO BOMBA AGUA	HOUSING
44	REC97395-08070	97395-08070-00	TORNILLO	BOLT
45	REC663-44366-00	663-44366-00	RETÉN	SEAL
46	REC90430-12072	90430-12072-00	JUNTA	GASKET
47	REC67F-45371-00AL	67F-45371-00	ÁNODO	ÁNODO

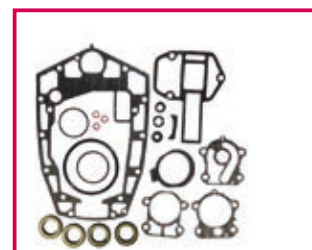

REF	OEM
REC688-W0001-22	688-W0001-22



REF	OEM
REC692-W0078-02	692-W0078-02

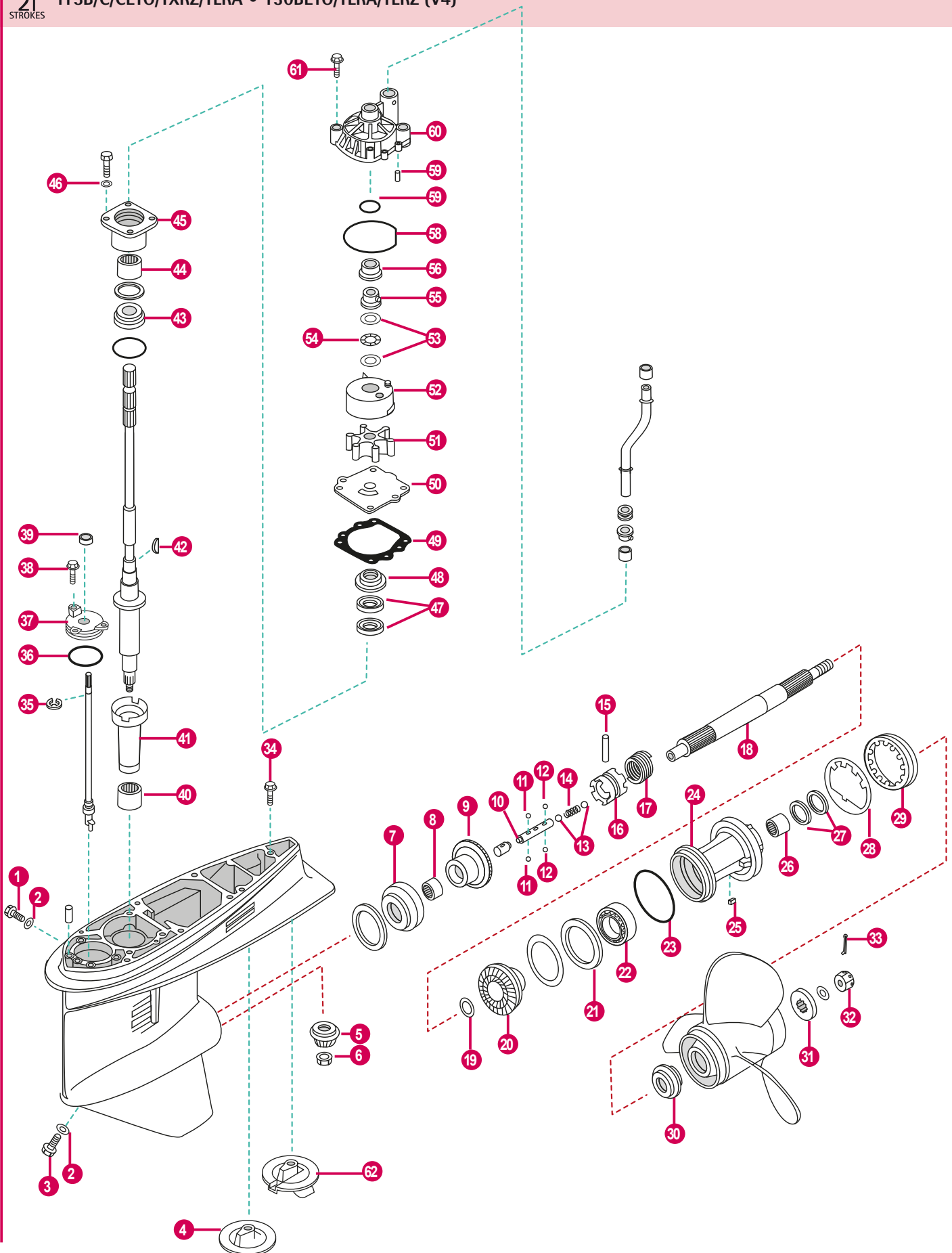

	REF	OEM		
1	REC90340-08002	90340-08M04	TAPÓN	PLUG, STRAIGHT SCREW
2	REC90430-08020	90430-08020	JUNTA	GASKET
3	REC688-45341-00	688-45341-00	TAPÓN	PLUG DRAIN
4	REC6E5-45371-01	6E5-45371-01	ZINC HÉLICE ALU	TAB-TRIM
5	REC6E5-45551-00	6E5-45551-02	PIÑÓN ATAQUE	INITIATIVE GEAR
6	REC90170-16M01	90170-16M01	TUERCA	NUT
7	REC93332-000U7	93332-000U7	RODAMIENTO	BEARING
8	REC93315-425U7	93315-425U7	RODAMIENTO	BEARING
9	REC6E5-45560-00	6E5-45560-01	PIÑÓN MARCHA AVANTE	POSITIVE GEAR ASSY
10	REC6E5-45634-01	6E5-45634-01	PASADOR DESPLAZABLE	SLIDE SHIFT
11	REC93507-32031	93507-32031	BOLA	BALL
12	REC93503-16003	93503-16003	BOLA	BALL
13	REC93511-32027	93511-32027	BOLA	BALL
14	REC90501-16M37	90501-16M37	MUELLE	SPRING, COMPRESSION
15	REC90250-08M07	90250-08M07	PASADOR	PIN STRAIGHT
16	REC6E5-45631-00	6E5-45631-01	DESPLAZABLE	CLUTCH, DOG
17	REC6E5-45633-01	6E5-45633-01	ARILLO METÁLICO	RING, CROSS PIN
18	REC6E5-45611-00	6E5-45611-01	EJE HÉLICE	SHAFT, PROPELLER
19	REC90201-30M92	90201-30M92	ARANDELA	WASHER, PLATE
20	REC6E5-45570-00	6E5-45571-01	PIÑÓN MARCHA ATRAS	REVERSE GEAR
21	REC6E5-45576-00	6E5-45576-00	ARANDELA	WASHER, THURST
22	REC93306-208U0	93306-208U0	RODAMIENTO	BEARING
23	REC93210-86M39	93210-86M39	ARO TÓRICO	O-RING
24	REC6E5-45332-00-94	6E5-45332-00-94	CUERPO COJINETE	HOUSING, BEARING
25	REC90282-04010	90282-04010	CHAVETA	KEY, STRAIGHT
26	REC93315-43061	93315-430U8	RODAMIENTO	BEARING
27	REC93101-30M17	93101-30M17	RETÉN	OIL SEAL
28	REC688-45383-01	688-45383-02	ARANDELA	WASHER, CLAW
29	REC688-45384-00	688-45384-00	TUERCA	NUT
30	REC6E5-45987-00	6E5-45987-01	SEPARADOR	SPACER
31	REC688-45997-00	688-45997-01	SEPARADOR	SPACER
32	REC90171-18M04	90171-18M04	TUERCA HÉLICE	NUT, CASTLE

	REF	OEM		
33	REC91490-30025	91490-40030	PASADOR ALETA	PIN, COTTER
34	PAT85-00000012	90105-10M00	TORNILLO	SCREW
35	REC99001-08600-00	99001-08600	CLIP	CLIP
36	REC93210-58677	93210-58144	ARO TÓRICO	O-RING
37	REC6E5-45321-00	6E5-45321-00	PLATO	PLATE
38	REC90119-06M10	90119-06M10	TORNILLO	BOLT WITH WASHER
39	REC93106-09014	93106-09014	RETÉN	OIL SEAL
40	REC93315-628U9	93315-628U9	RODAMIENTO	BEARING
41	REC6E5-45536-00	6E5-45536-00	CAMISA EJE DE MANDO	SLEEVE
42	REC90280-04M05	90280-04M05	CHAVETA	KEY, WOODRUF
43	REC93341-930V2	93341-930V2	RODAMIENTO	BEARING
44	REC93315-430V5	93317-330U2	RODAMIENTO	BEARING
45	REC6E5-45331-00-94	6E5-45331-00-94	CUERPO RODAMIENTO	HOUSING, BEARING
46	PAGB/T97.1-8	92995-08600	ARANDELA	WASHER
47	REC93101-28M16	93101-28M16	RETÉN	OIL SEAL
48	REC6E5-45344-00	6E5-45344-00	TAPA RETÉN	COVER, OIL SEAL
49	REC6E5-44315-A0	6E5-44315-A0	JUNTA BOMBA	GASKET, WATER PUMP
50	REC6E5-44323-00-40	6E5-44323-00	PLATO	OUTTER PLATE, CARTRIDGE
51	REC6E5-44352-01	6E5-44352-01	TURBINA	IMPELLER
52	REC61A-44322-02	61A-44322-02	CASQUILLO INOX	INSERT, CARTRIDGE
53	REC90201-22M01	90201-22M01	ARANDELA	WASHER
54	REC90206-22M19	90206-22M19	ARANDELA ONDULADA	WAVE WASHER
55	REC61A-45538-00	61A-45538-00	ESPACIADOR	SPACER
56	REC61A-45527-00	61A-45527-00	CASQUILLO	COLLAR, DRIVE SHAFT
57	REC93210-86M38	93210-86M38	ARO TÓRICO	O-RING
58	REC93210-37M67	93210-37160	ARO TÓRICO	O-RING
59	REC93606-12019	93606-12019	PIN CENTRADOR	PIN DOWEL
60	REC61A-44311-00	61A-44311-01	CUERPO BOMBA	HOUSING, WATER PUMP
61	REC90119-08M14	90119-08M14	TORNILLO	BOLT WITH WASHER
62	REC67F-45371-00AL	67F-45371-00	ÁNODO	ÁNODO



REF	OEM
REC6N6-W0078-02	6E5-W0078-02

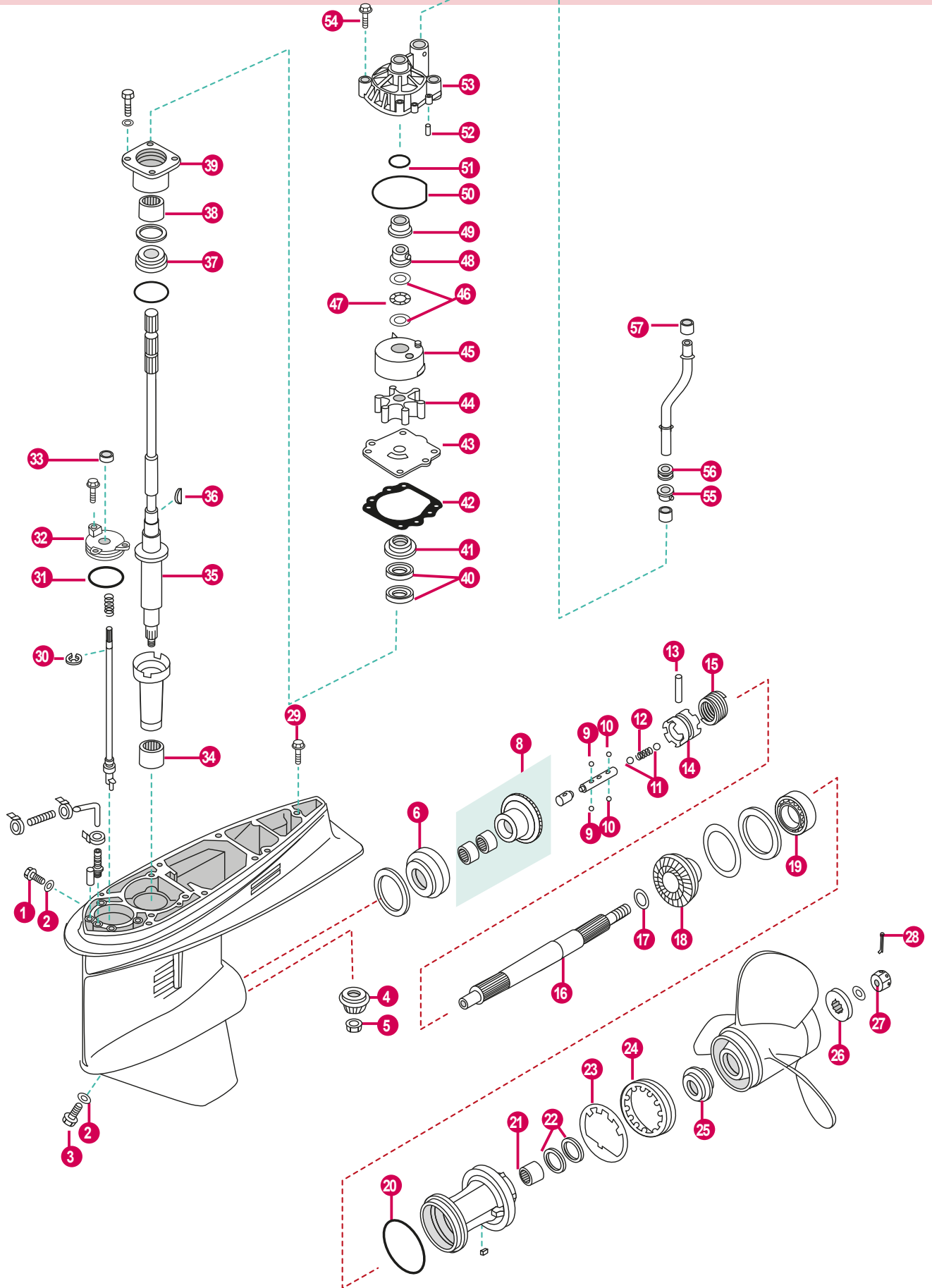

	REF	OEM		
1	REC90340-08002	90340-08002	TAPÓN	PLUG, STRAIGHT SCREW
2	REC90430-08020	90430-08020	JUNTA	GASKET
3	REC688-45341-00	688-45341-10	TAPÓN	PLUG, DRAIN
4	REC6G5-45551-00	6G5-45551-01	PIÑÓN ATAQUE	INITIATIVE GEAR
5	REC90170-16M01	93170-16M01	TUERCA	NUT
6	REC93332-000V3	93332-000V3	RODAMIENTO	BEARING
7	REC93315-425V3	93315-425V3	RODAMIENTO	BEARING
8	REC6G5-45560-00	6G5-45560-01	PIÑÓN MARCHA AVANTE	POSITIVE GEAR ASSY
9	REC93507-32031	93507-32031	BOLA	BALL
10	REC93503-16003	93503-16003	BOLA	BALL
11	REC93511-32027	93511-32027	BOLA	BALL
12	REC90501-16M37	90501-16M37	MUELLE	SPRING
13	REC90250-08M07	90250-08M07	PASADOR	PIN, STRAIGHT
14	REC6G5-45631-00	6G5-45631-00	DESPLAZABLE	CLUTCH, DOG
15	REC6E5-45633-01	6E5-45633-01	ANILLO	RING, CROSS PIN
16	REC6J9-45611-00	6J9-45611-01	EJE HÉLICE	SHAFT, PROPELLER
17	REC90201-30M92	90201-30M92	ARANDELA	WASHER, PLATE
18	REC6G5-45571-00	6G5-45571-02	PIÑÓN MARCHA ATRAS	REVERSE GEAR
19	REC93306-209U0	93306-209U0	RODAMIENTO	BEARING
20	REC93210-97M55	93210-97M55	ARO TÓRICO	O-RING
21	REC93315-43061	93315-43061	RODAMIENTO	BEARING
22	REC93101-30M17	93101-30M17	RETÉN	OIL SEAL
23	REC6G5-45383-01	6G5-45383-01	ARANDELA	WASHER, CLAW
24	REC6G5-45384-00	6G5-45384-00	TUERCA	NUT
25	REC6E5-45987-00	6E5-45987-01	ESPACIADOR	SPACER
26	REC688-45997-00	688-45997-01	ESPACIADOR	SPACER
27	REC90171-18M04	90171-18M04	TUERCA	NUT, CASTLE
28	REC91490-30025	91490-40030	PASADOR	PIN, COTTER
29	PAT85-00000012	90105-10M00	TORNILLO	SCREW
30	REC99001-08600-00	99001-08600	CLIP	BEARING
31	REC93210-58677	93210-58144	ARO TÓRICO	O-RING

	REF	OEM		
32	REC6E5-45321-00	6E5-45321-00	TAPA EJE	SHIFT COVER
33	REC93106-09014	93106-09014	RETÉN	OIL SEAL
34	REC93311-928U5	93311-928U5	RODAMIENTO	BEARING
35	REC6G5-45501-21	6G5-45501-21	EJE 25"	DRIVE SHAFT COMP. 25"
36	REC90280-04M05	90280-04M05	CHAVETA	KEY, WOODRUFF
37	REC93341-930V2	93341-930V2	RODAMIENTO	BEARING
38	REC93315-430V5	93317-330U2	RODAMIENTO	BEARING
39	REC6E5-45331-00-94	6E5-45331-00-94	CUERPO RODAMIENTO	HOUSING, BEARING
40	REC93101-28M16	93101-28M16	RETÉN	OIL SEAL
41	REC6E5-45344-00	6E5-45344-00	TAPA RETÉN	COVER, OIL SEAL
42	REC6E5-44315-A0	6E5-44315-A0	JUNTA	GASKET, WATER PUMP
43	REC6G5-44323-00	6G5-44323-00	PLATO	OUTER PLATE, CARTRIDGE
44	REC6E5-44352-01	6E5-44352-01	TURBINA	IMPELLER
45	REC61A-44322-02	61A-44322-02	CASQUILLO INOX -ANTIGUA-	INSERT, CARTRIDGE -OLDER-
	REC6E5-44322-00	6E5-44322-00	CASQUILLO INOX -MODERNA-	INSERT, CARTRIDGE -NEWER-
46	REC90201-22M01	90201-22M01	ARANDELA	WASHER
47	REC90206-22M19	90206-22M19	ARANDELA ONDULADA	WAVE WASHER
48	REC61A-45538-00	61A-45538-00	ESPACIADOR	SPACER
49	REC61A-45527-00	61A-45527-00	GOMA	COLLAR
50	REC93210-86M38	93210-86M38	ARO TÓRICO	O-RING
51	REC93210-37M67	93210-37160	ARO TÓRICO	O-RING
52	REC93606-12019	93606-12019	CENTRADOR	PIN, DOWEL
53	REC61A-44311-00	61A-44311-01	CUERPO BOMBA AGUA -ANTIGUA-	HOUSING, WATER PUMP -OLDER-
	REC61A-44311-00	6E5-44311-00	CUERPO BOMBA AGUA -MODERNA-	HOUSING, WATER PUMP -NEWER-
54	REC90119-08M14	90119-08M14	TORNILLO	BOLT, WITH WASHER
55	REC6E5-44365-00	6E5-44365-00	CASQUILLO GOMA	DAMPER, WATER SEAL
56	REC6E5-44366-00	6E5-44366-00	SELLO GOMA AGUA	DAMPER, WATER SEAL
57	REC6E5-44365-00	6E5-44365-00	SELLO GOMA AGUA	DAMPER, WATER SEAL



REF	OEM
REC6G5-W0078-A1	6G5-W0078-A1

	REF	OEM		
1	REC90340-08002	90340-08002	TORNILLO	VENT PLUG
2	REC90430-08020	90430-08020	JUNTA	GASKET, DRAIN PLUG
3	REC93311-83280	93311-83280	RODAMIENTO	BEARING
4	REC93315-43061	93315-43061	RODAMIENTO	PROP SHAFT BEARING
5	REC93101-30M17	93101-30M17	RETÉN	PROP SHAFT SEAL
6	REC688-45997-00	688-45997-00	ESPACIADOR	SPACER
7	REC90171-18M04	90171-18M04	TUERCA	PROP NUT
8	REC91490-30025	91490-40030	PIN	COTTER PIN
9	REC93608-12M05	93608-12M05	PIN	ALIGNMENT DOWELS
10	REC663-44366-00	663-44366-00	GOMA	SEAL
11	REC99001-08600-00	99001-08600	CLIP	CLIP
12	REC90119-06M10	90119-06M10	TORNILLO	BOLT
13	REC93106-09014	93106-09014	RETÉN	SEAL, SHIFT ROD
14	REC90280-04M05	90280-04M05	CHAVETA	WOODRUFF KEY
15	REC93341-93020	93341-93020	GRUESO RODAMIENTO	THRUST BEARING
16	REC93315-430V5	93317-330U2	RODAMIENTO	BEARING
17	REC93101-28M16	93101-28M16	RETÉN	DRIVE SHAFT SEAL
18	REC6E5-45344-00	6E5-45344-00	RETÉN	COVER, DRIVE SHAFT SEALS
19	REC6E5-44315-A0	6E5-44315-A0	JUNTA BASE	BASE GASKET
20	REC6G5-44323-00	6G5-44323-00	BASE BOMBA	WEAR PLATE
21	REC6E5-44352-01	6E5-44352-01	TURBINA	IMPELLER
22	REC61A-44322-02	61A-44322-02	CASQUILLO INOX.	WATER PUMP LINER
23	REC90201-22M01	90201-22M01	ARANDELA	WASHER
24	REC90206-22M19	90206-22M19	ARANDELA ONDULADA	WAVE WASHER
25	REC61A-45538-00	61A-45538-00	ESPACIADOR	SPACER
26	REC61A-45527-00	61A-45527-00	COLLAR	COLLAR
27	REC93210-86M38	93210-86M38	ARO TÓRICO	O-RING
28	REC93210-37M67	93210-37M67	ARO TÓRICO	O-RING
29	REC93606-12019	93606-12019	PASADOR CENTRAL	ALIGNMENT PIN
30	REC61A-44311-00	61A-44311-00	CUERPO BOMBA AGUA	WATER PUMP HOUSING
31	REC90119-08M14	90119-08M14	TORNILLO CON ARANDELA	BOLT WITH WASHER



REF	OEM
REC61A-W0078-A1	61A-W0078-A1

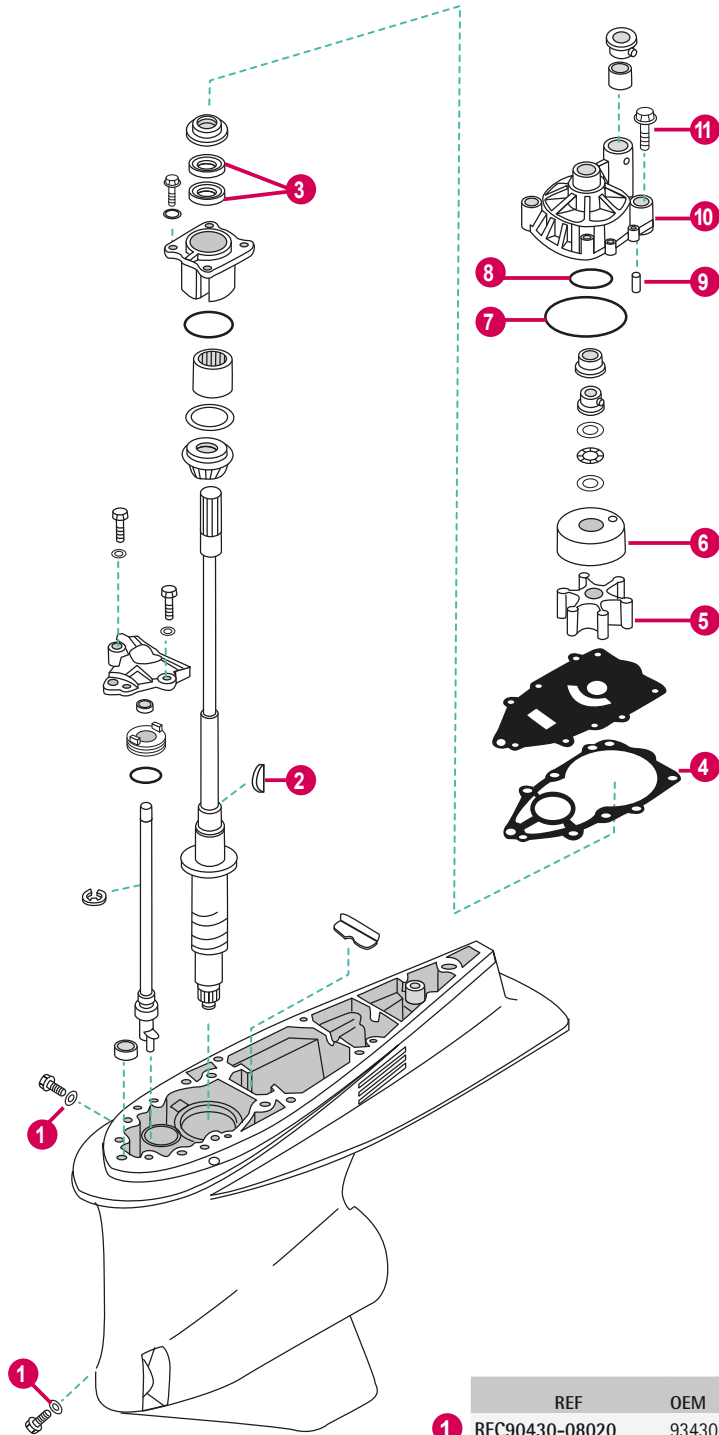



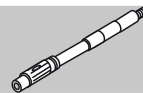



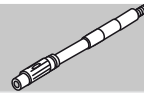

	REF	OEM		
1	REC90430-08020	93430-08020	JUNTA	GASKET, DRAIN FILL
2	REC90280-04M05	90280-04M05	CHAVETA	KEY, WOODRUFF
3	REC93101-28M16	93101-28M16	RETÉN	OIL SEAL
4	REC60X-44315-A0	60X-44315-A0	JUNTA	GASKET
5	REC6E5-44352-01	6E5-44352-01	IMPULSOR	IMPELLER
6	REC61A-44322-02	61A-44322-02	CASQUILLO INOX.	PUMP CUP
7	REC93210-86M38	93210-86M38	ARO TÓRICO	O-RING
8	REC93210-37M67	93210-37M67	ARO TÓRICO	O-RING
9	REC93606-12019	93606-42019	PASADOR	PIN, DOWELL
10	REC61A-44311-00	61A-44311-01	CUERPO BOMBA AGUA	WATER PUMP HOUSING
11	REC90119-08M14	90119-08M14	TORNILLO CON ARANDELA	BOLT W WASHER



2B	1981-03	REC646-45551-00	REC646-45560-00						
4A	1985-87	REC6E0-45551-00	REC6E0-45560-00	REC6E0-45570-00	REC6E0-45631-00		PAF4-03050001	REC6E0-45511-01	
4AC	1987-99	REC6E0-45551-00	REC6E0-45560-00	REC6E0-45570-00	REC6E0-45631-00		PAF4-03050001	REC6E0-45511-01	
4AC MHL	2001-03	REC6E0-45551-00	REC6E0-45560-00	REC6E0-45570-00	REC6E0-45631-00		PAF4-03050001	REC6E0-45511-11	
4AC MHS									
4AS	1987-96	REC6E0-45551-00	REC6E0-45560-00	REC6E0-45570-00	REC6E0-45631-00		PAF4-03050001	REC6E0-45511-01	
4BC	1998-99	REC6E0-45551-00	REC6E0-45560-00	REC6E0-45570-00	REC6E0-45631-00		PAF4-03050001	REC6E0-45511-01	
4BC MHL	2001-03	REC6E0-45551-00	REC6E0-45560-00	REC6E0-45570-00	REC6E0-45631-00		PAF4-03050001	REC6E0-45511-11	
4BC MHS									
F4A	1998-00	REC6E0-45551-00	PAF4-03010000	PAF4-03040000			PAF4-03050001	REC6E0-45511-11	
F4A MH									
F4A MHL	2000	REC6E0-45551-00	PAF4-03010000	PAF4-03040000			PAF4-03050001	REC6E0-45511-11	
F4A MHS	2001	REC6E0-45551-00	PAF4-03010000	PAF4-03040000			PAF4-03050001	REC6E0-45511-11	
5C	1985-99	REC6E0-45551-00	REC6E0-45560-00	REC6E0-45570-00	REC6E0-45631-00		PAF4-03050001	REC6E0-45511-01	
5C MHL									
5C MHS	2001-06	REC6E0-45551-00	REC646-45560-00	REC6E0-45570-00	REC6E0-45631-00		PAF4-03050001	REC6E0-45511-11	
5CS	1987-96	REC6E0-45551-00	REC646-45560-00	REC6E0-45570-00	REC6E0-45631-00			REC6E0-45511-01	
6C	1990-98	REC6N0-G5551-00	REC6N0-G5560-00	REC6N0-G5571-00	REC6G1-45631-00	REC6G1-45611-01			
6C MHL									
6C MHS	2001-06	REC6N0-G5551-00	REC6N0-G5560-00	REC6N0-G5571-00	REC6G1-45631-00	REC6G1-45611-01		REC6G1-45611-01	
6C WHL									
6C WHS	2001	REC6N0-G5551-00	REC6N0-G5560-00	REC6N0-G5571-00	REC6G1-45631-00	REC6G1-45611-01		REC6G1-45611-01	
6D	1990-98	REC6N0-G5551-00	REC6N0-G5560-00	REC6N0-G5571-00	REC6G1-45631-00	REC6G1-45611-01			
6D MHL									
6D MHS	2001-06	REC6N0-G5551-00	REC6N0-G5560-00	REC6N0-G5571-00	REC6G1-45631-00	REC6G1-45611-01		REC6G1-45611-01	
6D WHS	2001	REC6N0-G5551-00	REC6N0-G5560-00	REC6N0-G5571-00	REC6G1-45631-00	REC6G1-45611-01		REC6G1-45611-01	
8C	1990-98	REC6N0-G5551-00	REC6N0-G5560-00	REC6N0-G5571-00	REC6G1-45631-00	REC6G1-45611-01			
8C MHL									
8C MHS	2001-06	REC6N0-G5551-00	REC6N0-G5560-00	REC6N0-G5571-00	REC6G1-45631-00	REC6G1-45611-01		REC6G1-45611-01	
8C MHX									
8C WHL	2001-03	REC6N0-G5551-00	REC6N0-G5560-00	REC6N0-G5571-00	REC6G1-45631-00	REC6G1-45611-01		REC6G1-45611-01	
8C WHS									
E8D	1997-98	REC647-45551-00	REC647-45560-00	REC647-45570-00					
E8D MH	1999	REC647-45551-00	REC647-45560-00	REC647-45570-00					
F8A	1986-89				REC682-45631-00	REC648-45633-00			
F8B	1985-99	REC6E7-45551-00	REC6E7-45560-01	REC6E7-45570-00	REC682-45631-00	REC648-45633-00	REC683-45611-00		
F8B E									
F8B EH	1999	REC6E7-45551-00	REC6E7-45560-01	REC6E7-45570-00	REC682-45631-00	REC648-45633-00	REC683-45611-00		
F8B MH									
FT8D EL	2001-04					REC648-45633-00	REC683-45611-00		
FT8D EPL	2001-04					REC648-45633-00	REC683-45611-00		
FT8D EPX	2001-02					REC648-45633-00	REC683-45611-00		
FT8D EX	2001-04					REC648-45633-00	REC683-45611-00		
FT8D MHL									
FT8D MHX	2001-04					REC648-45633-00	REC683-45611-00		
9.9D	1985-89	REC6E7-45551-00	REC6E7-45560-01	REC6E7-45570-00	REC682-45631-00	REC648-45633-00	REC683-45611-00		
9.9D	1990-95	REC6E7-45551-00	REC6E7-45560-01	REC6E7-45570-00	REC682-45631-00	REC648-45633-00	REC683-45611-00	REC683-45361-02-4D	REC6E7-45501-11
9.9F	1995-99	REC63V-45551-00	REC6E7-45560-01	REC6E7-45570-00	REC682-45631-00	REC648-45633-00	REC683-45611-00	REC683-45361-02-4D	REC63V-45510-10
9.9F MH	2000	REC63V-45551-00	REC6E7-45560-01	REC6E7-45570-00	REC682-45631-00	REC648-45633-00	REC683-45611-00	REC683-45361-02-4D	REC63V-45510-01
9.9F MHL									REC63V-45510-11
9.9F MHS	2001-06	REC63V-45551-00	REC6E7-45560-01	REC6E7-45570-00	REC682-45631-00	REC648-45633-00	REC683-45611-00	REC683-45361-02-4D	REC63V-45510-01
9.9F WC									REC63V-45510-11
9.9F WH	2000	REC63V-45551-00	REC6E7-45560-01	REC6E7-45570-00	REC682-45631-00	REC648-45633-00	REC683-45611-00	REC683-45361-02-4D	REC63V-45510-01
9.9F WHL									REC63V-45510-11
9.9F WHS	2001	REC63V-45551-00	REC6E7-45560-01	REC6E7-45570-00	REC682-45631-00	REC648-45633-00	REC683-45611-00	REC683-45361-02-4D	REC63V-45510-01
F9.9B	1985-97	REC6E7-45551-00	REC6E7-45560-01	REC6E7-45570-00	REC682-45631-00	REC648-45633-00	REC683-45611-00	REC683-45361-02-4D	
F9.9B E	1999	REC6E7-45551-00	REC6E7-45560-01	REC6E7-45570-00	REC682-45631-00	REC648-45633-00	REC683-45611-00	REC683-45361-02-4D	
F9.9B EH	1999	REC6E7-45551-00	REC6E7-45560-01	REC6E7-45570-00	REC682-45631-00		REC683-45611-00	REC683-45361-02-4D	
F9.9B MH	1999	REC6E7-45551-00	REC6E7-45560-01	REC6E7-45570-00	REC682-45631-00	REC648-45633-00	REC683-45611-00	REC683-45361-02-4D	
F9.9C	1998	REC63V-45551-00	REC6E7-45560-01	REC6E7-45570-00	REC682-45631-00	REC648-45633-00	REC683-45611-00	REC683-45361-02-4D	REC63V-45510-01
F9.9C E	2000	REC63V-45551-00	REC6E7-45560-01	REC6E7-45570-00	REC682-45631-00	REC648-45633-00	REC683-45611-00	REC683-45361-02-4D	REC63V-45510-11
F9.9C EH	2000	REC63V-45551-00	REC6E7-45560-01	REC6E7-45570-00	REC682-45631-00	REC648-45633-00	REC683-45611-00	REC683-45361-02-4D	REC63V-45510-01
F9.9C EL									REC63V-45510-11
F9.9C ES	2001-06	REC63V-45551-00	REC6E7-45560-01	REC6E7-45570-00	REC682-45631-00	REC648-45633-00	REC683-45611-00	REC683-45361-02-4D	REC63V-45510-01
F9.9C MH	2000	REC63V-45551-00	REC6E7-45560-01	REC6E7-45570-00	REC682-45631-00	REC648-45633-00	REC683-45611-00	REC683-45361-02-4D	REC63V-45510-11
F9.9C MHL									REC63V-45510-01
F9.9C MHS	2001-06	REC63V-45551-00	REC6E7-45560-01	REC6E7-45570-00	REC682-45631-00	REC648-45633-00	REC683-45611-00	REC683-45361-02-4D	REC63V-45510-11
FT9.9A	1999				REC682-45631-00	REC648-45633-00			
FT9.9D	1999				REC682-45631-00	REC648-45633-00	REC683-45611-00		
FT9.9D E									
FT9.9D EH	2000				REC682-45631-00	REC648-45633-00	REC683-45611-00		



25D MHL	2001	REC689-45551-00	REC689-45560-00	REC689-45571-00-00	REC664-45631-00	REC648-45633-00			
25D MHS									
25J	1987-91					REC648-45633-00			
25J	1992-00					REC648-45633-00			
25N	1988					REC648-45633-00	REC6L2-45611-00		
25N MHOL	2001-06					REC648-45633-00	REC6L2-45611-00		
25N MHOS									
25N WOL	2001-03					REC648-45633-00	REC6L2-45611-00		
25N WOS									
25Q	1988-94	REC6H4-45551-00	REC6H4-45560-00	REC6H4-45570-00	REC663-45631-00	REC648-45633-00	REC679-45611-00		
25V	1996-98	REC61N-45551-00	REC61N-45560-10	REC61N-45570-00	REC664-45631-00	REC648-45633-00	REC6L2-45611-00		REC61N-45510-10
25V MHL									
25V MHS	2001	REC61N-45551-00	REC61N-45560-10	REC61N-45570-00	REC664-45631-00	REC648-45633-00	REC6L2-45611-00		REC61N-45510-10
25V WCS									
F25A E	2000	REC61N-45551-00	REC61N-45560-10	REC61N-45570-00	REC664-45631-00	REC648-45633-00	REC6L2-45611-00		REC61N-45510-10
F25A EH									
F25A EHL	2001-02	REC61N-45551-00	REC61N-45560-10	REC61N-45570-00	REC664-45631-00	REC648-45633-00	REC6L2-45611-00		REC61N-45510-10
F25A EHS	2001	REC61N-45551-00	REC61N-45560-10	REC61N-45570-00	REC664-45631-00	REC648-45633-00	REC6L2-45611-00		REC61N-45510-10
F25A EL									
F25A ES	2001-06	REC61N-45551-00	REC61N-45560-10	REC61N-45570-00	REC664-45631-00	REC648-45633-00	REC6L2-45611-00		REC61N-45510-10
F25A ETL									
F25A ET	2000	REC61N-45551-00	REC61N-45560-10	REC61N-45570-00	REC664-45631-00	REC648-45633-00	REC6L2-45611-00		REC61N-45510-10
F25A MH	2000	REC61N-45551-00	REC61N-45560-10	REC61N-45570-00	REC664-45631-00	REC648-45633-00	REC6L2-45611-00		REC61N-45510-10
F25A MHL	2001-06	REC61N-45551-00	REC61N-45560-10	REC61N-45570-00	REC664-45631-00	REC648-45633-00	REC6L2-45611-00		REC61N-45510-10
F25A MHS									
FT25B ED	2000						REC66T-45611-00	REC63D-45361-02-4D	
FT25B ET									
FT25B EDL	2001-02						REC66T-45611-00	REC63D-45361-02-4D	
FT25B EDX									
FT25B ETL	2001-06						REC66T-45611-00	REC63D-45361-02-4D	
FT25B ETX	2001-02						REC66T-45611-00	REC63D-45361-02-4D	
30A	1985	REC689-45551-00	REC689-45560-00	REC689-45571-00-00	REC664-45631-00	REC648-45633-00	REC689-45611-00		
30A M	1990-92	REC689-45551-00	REC689-45560-00	REC689-45571-00-00	REC664-45631-00	REC648-45633-00	REC689-45611-00		REC689-45501-10
30D	1986-00					REC648-45633-00			
30D EOL									
30D EOS									
30D ETOL	2001-06					REC648-45633-00			
30D MHOL									
30D MHOS									
30D OL	2001-03					REC648-45633-00			
30D EOS	2001-06					REC648-45633-00			
30G	1996	REC61N-45551-00	REC61N-45560-10	REC61N-45570-00	REC664-45631-00	REC648-45633-00	REC6L2-45611-00		REC61N-45510-00
30G	1996-98	REC61N-45551-00	REC61N-45560-10	REC61N-45570-00	REC664-45631-00	REC648-45633-00	REC6L2-45611-00		REC61N-45510-00
30G MHS	2001	REC61N-45551-00	REC61N-45560-10	REC61N-45570-00		REC648-45633-00	REC6L2-45611-00		REC61N-45510-00
30G WCS									
30H MHS	2001-02	REC61N-45551-00	REC61N-45560-10	REC61N-45570-00	REC664-45631-00	REC648-45633-00	REC6L2-45611-00		REC61N-45510-00
30H WCS	2001-02	REC61N-45551-00	REC61N-45560-10	REC61N-45570-00	REC664-45631-00	REC648-45633-00	REC6L2-45611-00		REC61N-45510-10
F30A ETL	2001-06	REC66T-45551-00	REC66T-45560-00	REC66T-45571-00	REC66T-45631-00		REC66T-45611-00	REC63D-45361-02-4D	PAF40-04010000L
F30A ETS	2001-06	REC66T-45551-00	REC66T-45560-00	REC66T-45571-00	REC66T-45631-00		REC66T-45611-00	REC63D-45361-02-4D	PAF40-04010000S
F30A MHDL	2001-06	REC66T-45551-00	REC66T-45560-00	REC66T-45571-00	REC66T-45631-00		REC66T-45611-00	REC63D-45361-02-4D	PAF40-04010000L
F30A MHDS	2001-06	REC66T-45551-00	REC66T-45560-00	REC66T-45571-00	REC66T-45631-00		REC66T-45611-00	REC63D-45361-02-4D	PAF40-04010000S
E40G WH	2003	REC6F5-45551-00	REC6F5-45560-00		REC663-45631-00	REC663-45633-00	REC6F6-45611-00	REC63D-45361-02-4D	REC676-45501-10
40H	1985-90	REC6H4-45551-00	REC6H4-45560-00	REC6H4-45570-00	REC6H4-45631-00	REC663-45633-00	REC679-45611-00		
40H	1991-93	REC6H4-45551-00	REC6H4-45560-00	REC6H4-45570-00	REC6H4-45631-00	REC663-45633-00	REC679-45611-00		
40Q	1993-98	REC6H9-45551-00	REC679-45560-00	REC677-41112-A0	REC663-45631-00	REC663-45633-00	REC679-45611-00		
40Q E	1992	REC6H9-45551-00	REC679-45560-00	REC677-41112-A0	REC663-45631-00	REC663-45633-00	REC679-45611-00		
40Q M	1990-92	REC6H9-45551-00	REC679-45560-00	REC677-41112-A0	REC663-45631-00	REC663-45633-00	REC679-45611-00		
40R MHO	2000	REC6H4-45551-00	REC6H4-45560-00	REC6H4-45570-00		REC663-45633-00		REC63D-45361-02-4D	
40R ROS	2001	REC6H4-45551-00	REC6H4-45560-00	REC6H4-45570-00		REC663-45633-00		REC63D-45361-02-4D	
40V	1995-98	REC6H4-45551-00	REC6H4-45560-00	REC6H4-45570-00		REC663-45633-00		REC63D-45361-02-4D	
40V EO	2000	REC6H4-45551-00	REC6H4-45560-00	REC6H4-45570-00		REC663-45633-00		REC63D-45361-02-4D	
40V ETO									
40V EOL	2001-06	REC6H4-45551-00	REC6H4-45560-00	REC6H4-45570-00		REC663-45633-00		REC63D-45361-02-4D	
40V EOS									
40V ETOL	2001-03	REC6H4-45551-00	REC6H4-45560-00	REC6H4-45570-00		REC663-45633-00		REC63D-45361-02-4D	
40V ETOS									
40V MHOL	2001-06	REC6H4-45551-00	REC6H4-45560-00	REC6H4-45570-00		REC663-45633-00		REC63D-45361-02-4D	
40V MHOS									
40V MO	2000	REC6H4-45551-00	REC6H4-45560-00	REC6H4-45570-00		REC663-45633-00		REC63D-45361-02-4D	
40X	1998	REC66T-45551-00	REC66T-45560-00	REC66T-45571-00	REC66T-45631-00	REC663-45633-00	REC66T-45611-00	REC63D-45361-02-4D	REC66T-45501-10
40X MH	2000	REC66T-45551-00	REC66T-45560-00	REC66T-45571-00	REC66T-45631-00	REC663-45633-00	REC66T-45611-00	REC63D-45361-02-4D	REC66T-45501-10
40X MHL	2001-06	REC66T-45551-00	REC66T-45560-00	REC66T-45571-00	REC66T-45631-00	REC663-45633-00	REC66T-45611-00	REC63D-45361-02-4D	REC66T-45501-10
40X MHS	2001-02	REC66T-45551-00	REC66T-45560-00	REC66T-45571-00	REC66T-45631-00	REC663-45633-00	REC66T-45611-00	REC63D-45361-02-4D	REC66T-45501-01
40X W	2000	REC66T-45551-00	REC66T-45560-00	REC66T-45571-00	REC66T-45631-00	REC663-45633-00	REC66T-45611-00	REC63D-45361-02-4D	REC66T-45501-10
40X WL									
40X WS	2001	REC66T-45551-00	REC66T-45560-00	REC66T-45571-00	REC66T-45631-00	REC663-45633-00	REC66T-45611-00	REC63D-45361-02-4D	REC66T-45501-10

									
40X WT	2000	REC66T-45551-00	REC66T-45560-00	REC66T-45571-00	REC66T-45631-00	REC663-45633-00	REC66T-45611-00	REC63D-45361-02-4D	REC66T-45501-10
40X WTL	2001-03	REC66T-45551-00	REC66T-45560-00	REC66T-45571-00	REC66T-45631-00	REC663-45633-00	REC66T-45611-00	REC63D-45361-02-4D	REC66T-45501-10
40Y ETOL	2001-06	REC6H4-45551-00	REC6H4-45560-00	REC6H4-45570-00				REC63D-45361-02-4D	
40Y MHOS									
E40G MH	2003	REC6F5-45551-00	REC6F5-45560-00		REC663-45631-00	REC663-45633-00	REC6F6-45611-00	REC676-45361-00	REC676-45501-10
E40G MHS									
E40G MHL	2003	REC6F5-45551-00	REC6F5-45560-00		REC663-45631-00	REC663-45633-00	REC6F6-45611-00	REC676-45361-00	
F40A	1999	REC6H4-45551-00	REC6H4-45560-00	REC6H4-45570-00		REC663-45633-00		REC63D-45361-02-4D	PAF40-04010000S
F40A ED	1999	REC6K5-45551-00	REC6K5-45560-00	REC6K5-45570-00		REC688-45633-00		REC63D-45361-02-4D	PAF40-04010000S
F40A EDL	2001	REC6H4-45551-00	REC6H4-45560-00	REC6H4-45570-00		REC688-45633-00		REC63D-45361-02-4D	PAF40-04010000L
F40A ET	1999	REC6K5-45551-00	REC6K5-45560-00	REC6K5-45570-00	REC688-45631-00	REC688-45633-00	REC688-45611-00	REC688-45331-00-94	
F40A ETL	2001-02	REC6H4-45551-00	REC6H4-45560-00	REC6H4-45570-00		REC688-45633-00		REC63D-45361-02-4D	
F40A ED	1999	REC6H4-45551-00	REC6H4-45560-00	REC6H4-45570-00	REC688-45631-00	REC663-45633-00	REC688-45611-00	REC688-45331-00-94	
F40B ED	2000-01	REC66T-45551-00	REC66T-45560-00	REC66T-45571-00	REC66T-45631-00		REC66T-45611-00	REC63D-45361-02-4D	PAF40-04010000S
F40B EDL	2001-06	REC66T-45551-00	REC66T-45560-00	REC66T-45571-00	REC66T-45631-00		REC66T-45611-00	REC63D-45361-02-4D	PAF40-04010000L
F40B EDS	2001-02	REC66T-45551-00	REC66T-45560-00	REC66T-45571-00	REC66T-45631-00		REC66T-45611-00	REC63D-45361-02-4D	PAF40-04010000S
F40B ET	2000-01	REC66T-45551-00	REC66T-45560-00	REC66T-45571-00	REC66T-45631-00		REC66T-45611-00	REC63D-45361-02-4D	PAF40-04010000L
E40B ETL	2001-06	REC66T-45551-00	REC66T-45560-00	REC66T-45571-00	REC66T-45631-00		REC66T-45611-00	REC63D-45361-02-4D	PAF40-04010000L
F40B ETS	2001-06	REC66T-45551-00	REC66T-45560-00	REC66T-45571-00	REC66T-45631-00		REC66T-45611-00	REC63D-45361-02-4D	PAF40-04010000S
F40B MHD	2000	REC66T-45551-00	REC66T-45560-00	REC66T-45571-00	REC66T-45631-00		REC66T-45611-00	REC63D-45361-02-4D	PAF40-04010000S
F40B MHDL	2001-06	REC66T-45551-00	REC66T-45560-00	REC66T-45571-00	REC66T-45631-00		REC66T-45611-00	REC63D-45361-02-4D	PAF40-04010000L
F40B MHDS	2001-06	REC66T-45551-00	REC66T-45560-00	REC66T-45571-00	REC66T-45631-00		REC66T-45611-00	REC63D-45361-02-4D	PAF40-04010000S
F45A	1996-99	REC6K5-45551-00	REC6K5-45560-00	REC6K5-45570-00	REC688-45631-00	REC688-45633-00	REC688-45611-00	REC688-45331-00-94	
F45A ED	2000	REC6K5-45551-00	REC6K5-45560-00	REC6K5-45570-00	REC688-45631-00	REC688-45633-00	REC688-45611-00	REC688-45331-00-94	
F45A ET									
50D	1984-90	REC6H4-45551-00	REC6H4-45560-00	REC6H4-45570-00	REC6H4-45631-00	REC663-45633-00	REC679-45611-00		
50D	1991-93	REC6H4-45551-00	REC6H4-45560-00	REC663-45631-00	REC6H4-45631-00	REC663-45633-00	REC679-45611-00		
50G	1993-98	REC6K5-45551-00	REC6K5-45560-00		REC663-45631-00	REC688-45633-00	REC697-45611-00	REC688-45331-00-94	
50G ETO	2000	REC6K5-45551-00	REC6K5-45560-00		REC663-45631-00	REC688-45633-00	REC697-45611-00	REC688-45331-00-94	
50G ETOL	2001-06	REC6K5-45551-00	REC6K5-45560-00		REC663-45631-00	REC688-45633-00	REC697-45611-00	REC688-45331-00-94	
50H	1995-98	REC6H4-45551-00	REC6H4-45560-00	REC6H4-45570-00		REC663-45633-00		REC63D-45361-02-4D	
50H EDO	2000	REC6H4-45551-00	REC6H4-45560-00	REC6H4-45570-00		REC663-45633-00		REC63D-45361-02-4D	
50H EDOL	2001-02	REC6H4-45551-00	REC6H4-45560-00	REC6H4-45570-00		REC663-45633-00		REC63D-45361-02-4D	
50H EDOS									
50H MDO	2000	REC6H4-45551-00	REC6H4-45560-00	REC6H4-45570-00		REC663-45633-00		REC63D-45361-02-4D	
50H MO									
F50A	1995	REC6H4-45551-00	REC6H4-45560-00	REC6H4-45570-00		REC663-45633-00		REC63D-45361-02-4D	
F50A ED	2000	REC6K5-45551-00	REC6K5-45560-00	REC6K5-45570-00		REC663-45633-00	REC688-45611-00		
F50A ET									
F50A EDL	2001-06	REC6H4-45551-00	REC6H4-45560-00			REC688-45633-00		REC63D-45361-02-4D	
F50A ETL									
F50B	1996-97	REC6K5-45551-00	REC6K5-45560-00	REC6K5-45570-00	REC688-45631-00	REC688-45633-00			
F50B	1998-99	REC6K5-45551-00	REC6K5-45560-00	REC6K5-45570-00				REC688-45331-00-94	
F50B ET	2000	REC6K5-45551-00	REC6K5-45560-00	REC6K5-45570-00	REC688-45631-00	REC663-45633-00	REC688-45611-00	REC688-45331-00-94	
FT50B	1998-99	REC6K5-45551-00	REC6K5-45560-00	REC6K5-45570-00	REC688-45631-00	REC688-45633-00	REC688-45611-00	REC688-45331-00-94	
FT50B ETL	2001-02					REC688-45633-00		REC63D-45361-02-4D	
FT50C ETL	2002-06		REC67F-45560-00			REC688-45633-00			
FT50G ETL	2005-06	REC6K5-45551-00	REC6K5-45560-00			REC688-45633-00			
55B	1993-98	REC697-45551-00	REC697-45560-00	REC697-45571-00-00	REC663-45631-00	REC663-45633-00	REC697-45611-00	REC663-45331-00-94	REC663-45510-01
55B E	1990-91	REC697-45551-00	REC697-45560-00	REC697-45571-00-00	REC663-45631-00	REC663-45633-00	REC697-45611-00	REC663-45331-00-94	REC663-45510-01
55B E	1992	REC697-45551-00	REC697-45560-00	REC697-45571-00-00	REC663-45631-00	REC663-45633-00	REC697-45611-00	REC663-45331-00-94	REC663-45510-01
55B EHD	2000	REC697-45551-00	REC697-45560-00	REC697-45571-00-00	REC663-45631-00	REC663-45633-00	REC697-45611-00		REC663-45510-01
55B ET									
55B ETL	2001-02	REC697-45551-00	REC697-45560-00	REC697-45571-00-00	REC663-45631-00	REC663-45633-00	REC697-45611-00	REC663-45331-00-94	
60F	1984-98	REC6K5-45551-00	REC6K5-45560-00		REC663-45631-00	REC688-45633-00	REC697-45611-00	REC688-45331-00-94	
60F EO	2000	REC6K5-45551-00	REC6K5-45560-00		REC663-45631-00	REC688-45633-00	REC697-45611-00	REC688-45331-00-94	
60F ETO									
60F ETOL	2001-06	REC6K5-45551-00	REC6K5-45560-00		REC663-45631-00	REC688-45633-00	REC697-45611-00	REC688-45331-00-94	
E60H MHDL	2001-06	REC6K5-45551-00	REC6K5-45560-00		REC6H1-45631-01	REC688-45633-00	REC6H1-45611-00	REC688-45331-00-94	
FT60B ETL	2003-06	REC6K5-45551-00	REC6K5-45560-00			REC688-45633-00			
FT60D ETL	2005-06	REC6K5-45551-00	REC6K5-45560-00			REC688-45633-00			
70B	1984-98	REC6K5-45551-00	REC6K5-45560-00		REC663-45631-00	REC688-45633-00	REC697-45611-00	REC688-45331-00-94	
70B EDOL	2001	REC6K5-45551-00	REC6K5-45560-00			REC688-45633-00	REC697-45611-00	REC688-45331-00-94	
70B EO	2000	REC6K5-45551-00	REC6K5-45560-00		REC663-45631-00	REC688-45633-00	REC697-45611-00	REC688-45331-00-94	
70B ETO									
70B ETOL	2001-06	REC6K5-45551-00	REC6K5-45560-00		REC663-45631-00	REC688-45633-00	REC697-45611-00	REC688-45331-00-94	
75A	1990-98	REC688-45551-00	REC688-45560-00	REC688-45571-00-00	REC688-45631-00	REC688-45633-00	REC688-45611-00	REC688-45331-00-94	
75A E	1990-00	REC688-45551-00	REC688-45560-00	REC688-45571-00-00	REC688-45631-00	REC688-45633-00	REC688-45611-00	REC688-45331-00-94	
75A EDL	2001-06	REC688-45551-00	REC688-45560-00	REC688-45571-00-00	REC688-45631-00	REC688-45633-00	REC688-45611-00	REC688-45331-00-94	
75A EM	1992-93	REC688-45551-00	REC688-45560-00	REC688-45571-00-00	REC688-45631-00	REC688-45633-00	REC688-45611-00	REC688-45331-00-94	

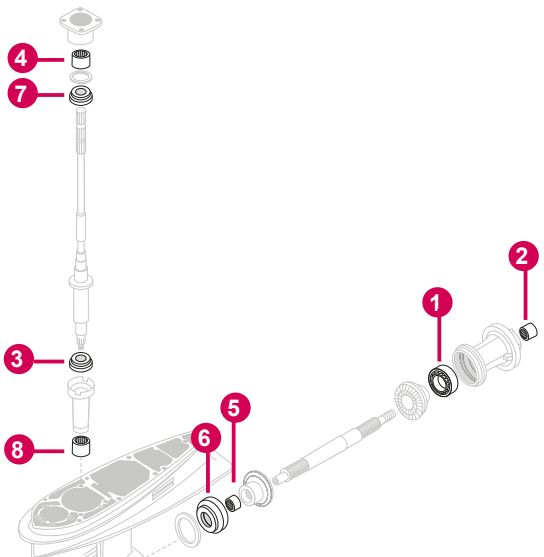

GUÍA RODAMIENTOS

STERN DRIVE BEARING APPLICATION

		1	2	3	4	5	6	7	8
F8A	1986-89				REC93315-317U2		REC93332-00005		REC93306-00501
F8B	1985-99	REC93315-314V8		REC93341-214U1	REC93315-317U2		REC93332-00005		REC93306-00501
F8B E F8B EH F8B MH	1999	REC93315-314V8		REC93341-41414	REC93315-317U2		REC93332-00005		REC93306-00501
FT8D EL FT8D EPL	2001-04	REC93315-314V8		REC93341-41414	REC93315-317U2		REC93332-00005		REC93306-00501
FT8D EPX	2001-02	REC93315-314V8		REC93341-41414	REC93315-317U2		REC93332-00005		REC93306-00501
FT8D EX FT8D MHL FT8D MHX	2001-04	REC93315-314V8		REC93341-41414	REC93315-317U2		REC93332-00005		REC93306-00501
9.9D	1985-89	REC93315-314V8		REC93341-41414	REC93315-317U2		REC93332-00005		REC93306-00501
9.9D	1985-95	REC93315-314V8		REC93341-214U1	REC93315-317U2		REC93332-00005		REC93306-00501
9.9D	1990-95	REC93315-314V8		REC93341-41414	REC93315-317U2		REC93332-00005		REC93306-00519
9.9F	1995-99	REC93315-314V8		REC93341-41414	REC93315-317U2		REC93332-00005		REC93306-00501
9.9F MH	2000	REC93315-314V8		REC93341-41414	REC93315-317U2		REC93332-00005		REC93306-00501
9.9F MHL 9.9F MHS	2001-06	REC93315-314V8		REC93341-41414	REC93315-317U2		REC93332-00005		REC93306-00501
9.9F WC 9.9F WH	2000	REC93315-314V8		REC93341-41414	REC93315-317U2		REC93332-00005		REC93306-00501
9.9F WHL 9.9F WHS	2001	REC93315-314V8		REC93341-41414	REC93315-317U2		REC93332-00005		REC93306-00501
F9.9B	1985-97	REC93315-314V8		REC93341-214U1	REC93315-317U2		REC93332-00005		REC93306-00501
F9.9B E F9.9B EH F9.9B MH	1999	REC93315-314V8		REC93341-41414	REC93315-317U2		REC93332-00005		REC93306-00501
F9.9C	1998	REC93315-314V8		REC93341-41414	REC93315-317U2		REC93332-00005		REC93306-00501
F9.9C E F9.9C EH	2000	REC93315-314V8		REC93341-41414	REC93315-317U2		REC93332-00005		REC93306-00501
F9.9C EL F9.9C ES	2001-06	REC93315-314V8		REC93341-41414	REC93315-317U2		REC93332-00005		REC93306-00501
F9.9C MH	2000	REC93315-314V8		REC93341-41414	REC93315-317U2		REC93332-00005		REC93306-00501
F9.9C MHL F9.9C MHS	2001-06	REC93315-314V8		REC93341-41414	REC93315-317U2		REC93332-00005		REC93306-00501
FT9.9A	1999				REC93315-317U2		REC93332-00005		REC93306-00501
FT9.9D	1999	REC93315-314V8		REC93341-41414	REC93315-317U2		REC93332-00005		REC93306-00501
FT9.9D E FT9.9D EH	2000	REC93315-314V8		REC93341-41414	REC93315-317U2		REC93332-00005		REC93306-00501
FT9.9D EHL FT9.9D EHX	2001	REC93315-314V8		REC93341-41414	REC93315-317U2		REC93332-00005		REC93306-00501
FT9.9D EL	2001-06	REC93315-314V8		REC93341-41414	REC93315-317U2		REC93332-00005		REC93306-00501
FT9.9D EP	2000	REC93315-314V8		REC93341-41414	REC93315-317U2		REC93332-00005		REC93306-00501
FT9.9D EPL FT9.9D EPX	2001-02	REC93315-314V8		REC93341-41414	REC93315-317U2		REC93332-00005		REC93306-00501
FT9.9D ES	2001	REC93315-314V8		REC93341-41414	REC93315-317U2		REC93332-00005		REC93306-00501
FT9.9D EX	2001-06	REC93315-314V8		REC93341-41414	REC93315-317U2		REC93332-00005		REC93306-00501
FT9.9D MH	2000	REC93315-314V8		REC93341-41414	REC93315-317U2		REC93332-00005		REC93306-00501
FT9.9D MHL	2001-06	REC93315-314V8		REC93341-41414	REC93315-317U2		REC93332-00005		REC93306-00501
FT9.9D MHX	2001	REC93315-314V8		REC93341-41414	REC93315-317U2		REC93332-00005		REC93306-00501
13.5A	1999	REC93315-314V8		REC93341-41414	REC93315-317U2		REC93332-00005		REC93306-00501
13.5A MH	2000	REC93315-314V8		REC93341-41414	REC93315-317U2		REC93332-00005		REC93306-00501
13.5A MHL 13.5A MHS	2001-04	REC93315-314V8		REC93341-41414	REC93315-317U2		REC93332-00005		REC93306-00501
13.5A WH	2000	REC93315-314V8		REC93341-41414	REC93315-317U2		REC93332-00005		REC93306-00501
F13.5A EHL	2005-06	REC93315-314V8			REC93315-317U2		REC93332-00005		REC93306-00501

**1****2****3****4****5****6****7****8**

F13.5A EPL	2005	REC93315-314V8		REC93341-41414	REC93315-317U2		REC93332-00005		REC93306-00501
F13.5A EPS	2005	REC93315-314V8			REC93315-317U2		REC93332-00005		REC93306-00501
F13.5A MH	2001	REC93315-314V8			REC93315-317U2				REC93306-00501
F13.5A MHL	2002-06	REC93315-314V8		REC93341-41414	REC93315-317U2		REC93332-00005		REC93306-00501
F13.5A MHS									
15D	1985-95	REC93315-314V8		REC93341-214U1	REC93315-317U2		REC93332-00005		REC93306-00501
15D	1990-95	REC93315-314V8		REC93341-41414	REC93315-317U2		REC93332-00005		REC93306-00501
15F	1995-99	REC93315-314V8		REC93341-41414	REC93315-317U2		REC93332-00005		REC93306-00501
15F MH	2000	REC93315-314V8		REC93341-41414	REC93315-317U2		REC93332-00005		REC93306-00501
15F MHL	2001-06	REC93315-314V8		REC93341-41414	REC93315-317U2		REC93332-00005		REC93306-00501
15F MHS									
15F WC	2000	REC93315-314V8		REC93341-41414	REC93315-317U2		REC93332-00005		REC93306-00501
15F WCL	2001-03	REC93315-314V8		REC93341-41414	REC93315-317U2		REC93332-00005		REC93306-00501
15F WCS	2001-02	REC93315-314V8		REC93341-41414	REC93315-317U2		REC93332-00005		REC93306-00501
F15A	1998	REC93315-314V8		REC93341-41414	REC93315-317U2		REC93332-00005		REC93306-00501
F15A E	1998-00	REC93315-314V8		REC93341-41414	REC93315-317U2		REC93332-00005		REC93306-00501
F15A EH									
F15A EHS									
F15A EHL	2001-06	REC93315-314V8		REC93341-41414	REC93315-317U2		REC93332-00005		REC93306-00501
F15A EL									
F15A EP	2000	REC93315-314V8		REC93341-41414	REC93315-317U2		REC93332-00005		REC93306-00501
F15A EPL	2001-06	REC93315-314V8		REC93341-41414	REC93315-317U2		REC93332-00005		REC93306-00501
F15A EPS									
F15A ES									
F15A MH	1998-00	REC93315-314V8		REC93341-41414	REC93315-317U2		REC93332-00005		REC93306-00501
F15A MHL	2001-06	REC93315-314V8		REC93341-41414	REC93315-317U2		REC93332-00005		REC93306-00501
F15A MHS									
20C	1985-93	REC93315-017U4			REC93315-22004		REC93332-00005		REC93306-00612
20C M	1990-97	REC93315-017U4			REC93315-22004		REC93332-00005		REC93306-00612
20C MH	1998	REC93315-017U4			REC93315-22004		REC93332-00005		REC93306-00612
20C MHL	2001-02	REC93315-017U4			REC93315-22004		REC93332-00005		REC93306-00612
20C MHS									
20D	1988		REC93315-22004		REC93315-22004		REC93332-00005		REC93306-00612
20D MHOL	2001-06		REC93315-22004		REC93315-22004		REC93332-00005		REC93306-00612
20D MHOS									
20D WOL	2001		REC93315-22004		REC93315-22004		REC93332-00005		REC93306-00612
20D WOS									
F20A	1998-99	REC93315-220V7	REC93332-000W5		REC93315-22004		REC93332-00005		REC93306-00612
F20A E	2000		REC93332-000W5		REC93315-22004		REC93332-00005		REC93306-00612
F20A EH	2000	REC93315-220V7	REC93332-000W5		REC93315-22004		REC93332-00005		REC93306-00612
F20A EHS	2001	REC93315-220V7			REC93315-22004		REC93332-00005		REC93306-00612
F20A EL	2001	REC93315-220V7	REC93332-000W5		REC93315-22004		REC93332-00005		REC93306-00612
F20A ES	2001-06	REC93315-220V7	REC93332-000W5		REC93315-22004		REC93332-00005		REC93306-00612
F20A ET	2000	REC93315-220V7	REC93332-000W5		REC93315-22004		REC93332-00005		REC93306-00612
F20A ETL	2003-06	REC93315-220V7	REC93332-000W5		REC93315-22004		REC93332-00005		REC93306-00612
F20A MH	2000	REC93315-220V7	REC93332-000W5		REC93315-22004		REC93332-00005		REC93306-00612
F20A MHL									
F20A MHS	2001	REC93315-220V7	REC93332-000W5		REC93315-22004		REC93332-00005		REC93306-00612
25B	1994-95	REC93315-325V1	REC93332-00001		REC93317-22204		REC93332-000W7		REC93306-00702
25B MHL	2001-06	REC93315-220V7	REC93332-000W5		REC93315-22004		REC93332-00005		REC93306-00612
25B MHS									
25B WCS	2001-02	REC93315-220V7	REC93332-000W5		REC93315-22004		REC93332-00005		REC93306-00612
25D	1985-87	REC93315-017U4			REC93315-22004		REC93332-00005		REC93306-00612
25D M	1990-97	REC93315-017U4			REC93315-22004		REC93332-00005		REC93306-00612
25D MH	1998	REC93315-017U4			REC93315-22004		REC93332-00005		REC93306-00612
25D MHL	2001	REC93315-017U4			REC93315-22004		REC93332-00005		REC93306-00612
25D MHS									
25J	1987-91	REC93315-220V7	REC93332-00001		REC93315-22004				REC93306-00612
25J	1992-00		REC93332-00001						REC93306-00612
25N	1988		REC93315-22004		REC93315-22004		REC93332-00005		REC93306-00612
25N MHOL	2001-06		REC93315-22004		REC93315-22004		REC93332-00005		REC93306-00612
25N MHOS									
25N WOL	2001-03		REC93315-22004		REC93315-22004		REC93332-00005		REC93306-00612
25N WOS	2001-03				REC93315-22004		REC93332-00005		REC93306-00612
25Q	1988-91	REC93315-32224	REC93332-00001						REC93306-00612
25Q	1990-94	REC93315-32224	REC93332-00001		REC93317-22204				REC93306-00702
25V	1996-98	REC93315-220V7	REC93332-000W5		REC93315-22004		REC93332-00005		REC93306-00612
25V MHL	2001	REC93315-220V7	REC93332-000W5		REC93315-22004		REC93332-00005		REC93306-00612
25V MHS									
25V WVS									
F25A E	2000	REC93315-220V7	REC93332-000W5		REC93315-22004		REC93332-00005		REC93306-00612
F25A EH									
F25A EHL	2001-02	REC93315-220V7	REC93332-000W5		REC93315-22004		REC93332-00005		REC93306-00612
F25A EHS	2001	REC93315-220V7	REC93332-000W5		REC93315-22004		REC93332-00005		REC93306-00612
F25A EL	2001-06	REC93315-220V7	REC93332-000W5		REC93315-22004		REC93332-00005		REC93306-00612
F25A ES									
F25A ET	2000	REC93315-220V7	REC93332-000W5		REC93315-22004		REC93332-00005		REC93306-00612

	1	2	3	4	5	6	7	8
F25A ETL	2001-06	REC93315-220V7	REC93332-000W5	REC93317-22204		REC93332-00005		REC93306-00612
F25A MH	2000	REC93315-220V7	REC93332-000W5	REC93315-22004		REC93332-00005		REC93306-00612
F25A MHL F25A MHS	2001-06	REC93315-220V7	REC93332-000W5	REC93315-22004		REC93332-00005		REC93306-00612
FT25B ED	2000	REC93315-32224	REC93332-00001	REC93317-22204		REC93332-00003		REC93306-001U1
FT25B EDL FT25B EDX	2001-02	REC93315-32224	REC93332-00001	REC93317-22204		REC93332-00003		REC93306-001U1
FT25B ET	2000	REC93315-32224	REC93332-00001	REC93317-22204		REC93332-00003		REC93306-001U1
FT25B ETL	2001-06	REC93315-32224	REC93332-00001	REC93317-22204		REC93332-00003		REC93306-001U1
FT25B ETX	2001-02	REC93315-32224	REC93332-00001	REC93317-22204		REC93332-00003		REC93306-001U1
30A	1985	REC93315-017U4		REC93315-22004		REC93332-00005		REC93306-00612
30A M	1990-92	REC93315-017U4	REC93315-22004	REC93315-22004		REC93332-00005		REC93306-00612
30D	1986-00	REC93315-220V7	REC93332-00001	REC93315-22004				REC93306-00612
30D EOL 30D EOL 30D ETOL 30D MHOL 30D MHOS	2001-06	REC93315-220V7	REC93332-00001	REC93315-22004				REC93306-00612
30D OL	2001-03		REC93332-00001	REC93315-22004				REC93306-00612
30D EOS	2001-06		REC93332-00001	REC93315-22004				REC93306-00612
30G	1996-98	REC93315-220V7	REC93332-000W5	REC93315-22004		REC93332-00005		REC93306-00612
30G MHS 30G WCS	2001	REC93315-220V7	REC93332-000W5	REC93315-22004		REC93332-00005		REC93306-00612
30H MHS 30H WCS	2001-02	REC93315-220V7	REC93332-000W5	REC93315-22004		REC93332-00005		REC93306-00612
F30A ETL F30A ETS F30A MHDL F30A MHDS	2001-06	REC93315-32224	REC93332-00001	REC93317-22204		REC93332-00003		REC93306-001U1
40G WH	2003	REC93315-324U1	REC93315-217U0			REC93332-000U0		
40H	1985-90	REC93315-32224	REC93332-00001	REC93317-22204				REC93306-00702
40H	1991-93	REC93315-32224	REC93332-00001	REC93317-22204				REC93306-00702
40Q	1993	REC93315-32224	REC93332-00001	REC93317-22204		REC93332-00003		REC93306-00702
40Q E	1992	REC93315-32224	REC93332-00001	REC93317-22204		REC93332-00003		REC93306-00702
40Q M	1990	REC93315-32224	REC93332-00001	REC93317-22204		REC93332-00003		REC93306-00702
40R MHO	2000	REC93315-32224	REC93332-00001	REC93317-22204		REC93332-00003		REC93306-001U1
40R ROS	2001	REC93315-32224	REC93332-00001	REC93317-22204		REC93332-00003		REC93306-001U1
40V	1995-98	REC93315-32224	REC93332-00001	REC93317-22204		REC93332-00003		REC93306-001U1
40V EO	2000	REC93315-32224	REC93332-00001	REC93317-22204		REC93332-00003		REC93306-001U1
40V EOL 40V EOS	2001-06	REC93315-32224	REC93332-00001	REC93317-22204		REC93332-00003		REC93306-001U1
40V ETO	2000	REC93315-32224	REC93332-00001	REC93317-22204		REC93332-00003		REC93306-001U1
40V ETOL 40V ETOS	2001-03	REC93315-32224	REC93332-00001	REC93317-22204		REC93332-00003		REC93306-001U1
40V MHOL 40V MHOS	2001-06	REC93315-32224	REC93332-00001	REC93317-22204		REC93332-00003		REC93306-001U1
40V MO	2000	REC93315-32224	REC93332-00001	REC93317-22204		REC93332-00003		REC93306-001U1
40X	1998	REC93315-32224	REC93332-00001	REC93317-22204		REC93332-00003		REC93306-001U1
40X MH	2000	REC93315-32224	REC93332-00001	REC93317-22204		REC93332-00003		REC93306-001U1
40X MHL	2001-06	REC93315-32224	REC93332-00001	REC93317-22204		REC93332-00003		REC93306-001U1
40X MHS	2001-02	REC93315-32224	REC93332-00001	REC93317-22204		REC93332-00003		REC93306-001U1
40X W	2000	REC93315-32224	REC93332-00001	REC93317-22204		REC93332-00003		REC93306-001U1
40X WL 40X WS	2001	REC93315-32224	REC93332-00001	REC93317-22204		REC93332-00003		REC93306-001U1
40X WT	2000		REC93332-00001	REC93317-22204		REC93332-00003		REC93306-001U1
40X WTL	2001-03	REC93315-32224	REC93332-00001	REC93317-22204		REC93332-00003		REC93306-001U1
40Y ETOL 40Y MHOS	2001-06	REC93315-32224	REC93332-00001	REC93317-22204		REC93332-00003		REC93306-001U1
E40G MH / MHS	2003	REC93315-324U1	REC93315-217U0			REC93332-000U0		REC93332-000U0
E40G MHL	2003	REC93315-324U1	REC93315-217U0			REC93332-000U0		
F40A F40A ED	1999	REC93315-32224	REC93332-00001	REC93317-22204		REC93332-00003		REC93306-001U1
F40A EDL	2001	REC93315-32224	REC93332-00001	REC93317-22204		REC93332-00003		REC93306-001U1
F40A ET	1999	REC93315-32224	REC93332-00001	REC93317-22204		REC93332-00003		REC93306-001U1
F40A ETL	2001-02	REC93315-32224	REC93332-00001	REC93317-22204		REC93332-00003		REC93306-001U1
F40A ED	1999	REC93315-325V1	REC93332-00001	REC93317-22204		REC93332-00003		REC93306-207U0
F40B ED	2000-01	REC93315-32224	REC93332-00001	REC93317-22204		REC93332-00003		REC93306-001U1
F40B EDL	2001-06	REC93315-32224	REC93332-00001	REC93317-22204		REC93332-00003		REC93306-001U1
F40B EDS	2001-02	REC93315-32224	REC93332-00001	REC93317-22204		REC93332-00003		REC93306-001U1
F40B ET	2000-01	REC93315-32224	REC93332-00001	REC93317-22204		REC93332-00003		REC93306-001U1
F40B ETL F40B ETS	2001-06	REC93315-32224	REC93332-00001	REC93317-22204		REC93332-00003		REC93306-001U1
F40B MHD	2000	REC93315-32224	REC93332-00001	REC93317-22204		REC93332-00003		REC93306-001U1
F40B MHDL F40B MHDS	2001-06	REC93315-32224	REC93332-00001	REC93317-22204		REC93332-00003		REC93306-001U1
F40C ETL	2002-06	REC93315-32224	REC93332-00001	REC93317-22204				



1 2 3 4 5 6 7 8

F45A	1996-99	REC93315-32224	REC93332-00001		REC93317-22204		REC93332-000W7		REC93306-001U1
F45A ED									
F45A ET	2000	REC93315-32224	REC93332-00001		REC93317-22204		REC93332-000W7		REC93306-001U1
50D	1984-90	REC93315-32224	REC93332-00001		REC93317-22204				REC93306-00702
50D	1991-93	REC93315-32224	REC93332-00001						REC93306-00702
50G	1993-98	REC93315-325V1	REC93332-00001		REC93317-22204		REC93332-000W7		REC93306-00702
50G ETO	2000	REC93315-325V1	REC93332-00001		REC93317-22204		REC93332-00003		REC93306-00702
50G ETOL	2001-06	REC93315-325V1	REC93332-00001		REC93317-22204		REC93332-00003		REC93306-00702
50H	1995-98	REC93315-32224	REC93332-00001		REC93317-22204		REC93332-00003		REC93306-001U1
50H EDO	2000	REC93315-32224	REC93332-00001		REC93317-22204		REC93332-00003		REC93306-001U1
50H EDOL									
50H EDOS	2001-02	REC93315-32224	REC93332-00001		REC93317-22204		REC93332-00003		REC93306-001U1
50H MDO									
50H MO	2000	REC93315-32224	REC93332-00001		REC93317-22204		REC93332-00003		REC93306-001U1
F50A	1995	REC93315-32224	REC93332-000U3		REC93317-22204		REC93332-00003		REC93306-001U1
F50A ED	2000	REC93315-32224	REC93332-00001		REC93317-22204		REC93332-00003		REC93306-001U1
F50A EDL	2001-06	REC93315-32224	REC93332-00001		REC93317-22204		REC93332-00003		REC93306-001U1
F50A ET	2000	REC93315-32224	REC93332-00001		REC93317-22204		REC93332-00003		REC93306-001U1
F50A ETL	2001-06	REC93315-32224	REC93332-00001		REC93317-22204		REC93332-00003		REC93306-001U1
F50B	1996-97	REC93315-32224	REC93332-00001		REC93317-22204		REC93332-00003		REC93306-001U1
F50B	1998-99	REC93315-325V1	REC93332-000U3		REC93317-22204		REC93332-000W7		REC93306-001U1
F50B ET	2000	REC93315-32224	REC93332-00001		REC93317-22204		REC93332-00003		REC93306-001U1
F50F EDL									
F50F ETL	2005-06	REC93315-32224	REC93332-00001		REC93317-22204				REC93306-001U1
FT50B	1998-99	REC93315-32224	REC93332-00001		REC93317-22204		REC93332-000W7		REC93306-001U1
FT50B ETL	2001-02	REC93315-32224	REC93332-00001		REC93317-22204		REC93332-00003		REC93306-001U1
FT50C ETL	2002-06	REC93315-32224	REC93332-00001		REC93317-22204		REC93332-00003		REC93306-001U1
FT50G ETL	2005-06		REC93332-000U3		REC93317-325U0				REC93306-001U1
55B	1993-98	REC93315-32224	REC93332-00001		REC93317-22204		REC93332-00003		REC93306-00702
55B E	1990-91	REC93315-32224	REC93332-00001		REC93317-22204		REC93332-00003		REC93306-00702
55B E	1992	REC93315-32224	REC93332-00001		REC93317-22204		REC93332-00003		REC93306-00702
55B EHD									
55B ET	2000	REC93315-32224	REC93332-00001		REC93317-22204		REC93332-00003		REC93306-00702
55B ETL	2001-02	REC93315-32224	REC93332-00001		REC93317-22204		REC93332-00003		REC93306-00702
60F	1984-98	REC93315-325V1	REC93332-00001		REC93317-22204		REC93332-000W7		REC93306-00702
60F EO									
60F ETO	2000	REC93315-325V1	REC93332-00001		REC93317-22204		REC93332-00003		REC93306-00702
60F ETOL	2001-06	REC93315-325V1	REC93332-00001		REC93317-22204		REC93332-00003		REC93306-00702
E60H MHDL	2001-06	REC93315-325V1	REC93332-000U3		REC93317-325U0		REC93332-000W7		REC93306-207U0
F60A ETL	2002-06	REC93315-32224	REC93332-00001		REC93317-22204				REC93306-001U1
F60C ETL	2005-06	REC93315-32224	REC93332-00001		REC93317-22204				REC93306-001U1
FT60B ETL	2003-06		REC93332-000U3		REC93317-325U0				REC93306-207U0
FT60D ETL	2005-06		REC93332-000U3		REC93317-325U0				REC93306-207U0
70B	1984-98	REC93315-325V1	REC93332-00001		REC93317-22204		REC93332-000W7		REC93306-00702
70B EDOL	2001	REC93315-325V1	REC93332-00001		REC93317-22204		REC93332-00003		REC93306-00702
70B EO									
70B ETO	2000	REC93315-325V1	REC93332-00001		REC93317-22204		REC93332-00003		REC93306-00702
70B ETOL	2001-06	REC93315-325V1	REC93332-00001		REC93317-22204		REC93332-00003		REC93306-00702
75A	1990-98	REC93315-325V1	REC93332-000U3		REC93317-325U0		REC93332-000W7		REC93306-207U0
75A E	1990-00	REC93315-325V1	REC93332-000U3		REC93317-325U0		REC93332-000W7		REC93306-207U0
75A EDL	2001-06	REC93315-325V1	REC93332-000U3		REC93317-325U0		REC93332-000W7		REC93306-207U0
75A EM	1992-93		REC93332-000U3		REC93317-325U0		REC93332-000W7		REC93306-207U0
75A ET	2000	REC93315-325V1			REC93317-325U0		REC93332-000W7		REC93306-207U0
75A ETL	2001-02	REC93315-325V1	REC93332-000U3		REC93317-325U0		REC93332-000W7		REC93306-207U0
75A MHD	2000	REC93315-325V1	REC93332-000U3		REC93317-325U0				REC93306-207U0
75C	1998	REC93315-325V1			REC93317-325U0		REC93332-000W7		REC93306-207U0
75C ETO	2000	REC93315-325V1	REC93332-000U3		REC93317-325U0		REC93332-000W7		REC93306-207U0
75C ETOL	2001-06	REC93315-325V1	REC93332-000U3		REC93317-325U0		REC93332-000W7		REC93306-207U0
80A	1985-96	REC93315-325V1	REC93332-000U3		REC93317-325U0		REC93332-000W7		REC93306-207U0
F80A	1999		REC93332-000U3		REC93317-325U0	REC93317-322V0			REC93306-207U0
F80A ET	2000		REC93332-000U3		REC93317-325U0	REC93317-322V0			REC93306-207U0
F80A ETL	2001-06		REC93332-000U3		REC93317-325U0	REC93317-322V0			REC93306-207U0
F80A ETX	2001		REC93332-000U3		REC93317-325U0	REC93317-322V0			REC93306-207U0
F80B ETL	2005-06		REC93332-000U3		REC93317-325U0	REC93317-322V0			REC93306-207U0
85A	1996-98	REC93315-325V1	REC93332-000U3		REC93317-325U0		REC93332-000W7		REC93306-207U0
85A E	1990-00	REC93315-325V1	REC93332-000U3		REC93317-325U0		REC93332-000W7		REC93306-207U0
85A ET	2000	REC93315-325V1	REC93332-000U3		REC93317-325U0		REC93332-000W7		REC93306-207U0
85A ETL	2001-02	REC93315-325V1	REC93332-000U3		REC93317-325U0		REC93332-000W7		REC93306-207U0
90A	1984-98	REC93315-325V1	REC93332-000U3		REC93317-325U0		REC93332-000W7		REC93306-207U0

YAMAHA

RECMAR®

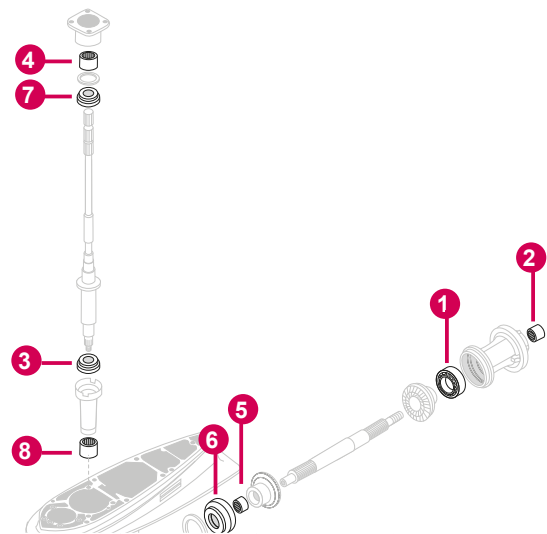

YAMAHA

RECMAR®

1141

		1	2	3	4	5	6	7	8
90A ETO	2000	REC93315-325V1	REC93332-000U3		REC93317-325U0		REC93332-000U7		REC93306-207U0
90A ETOL	2001-06	REC93315-325V1	REC93332-000U3		REC93317-325U0		REC93332-000W7		REC93306-207U0
100A	1998	REC93315-628U9	REC93315-430V5 REC93341-930V2		REC93315-43061	REC93315-425U7	REC93332-000U7		REC93306-208U0
100A ETO	2000	REC93315-628U9	REC93315-430V5 REC93341-930V2		REC93315-43061	REC93315-425U7			REC93306-208U0
100A ETOL	2001	REC93315-628U9	REC93315-430V5 REC93341-930V2		REC93315-43061	REC93315-425U7	REC93332-000U7		REC93306-208U0
F100A	1999		REC93332-000U3		REC93317-325U0	REC93317-322V0			REC93306-207U0
F100A ET	2000		REC93332-000U3		REC93317-325U0	REC93317-322V0			REC93306-207U0
F100A ETL	2001-06		REC93332-000U3		REC93317-325U0	REC93317-322V0			REC93306-207U0
F100A ETX	2001		REC93332-000U3		REC93317-325U0	REC93317-322V0			REC93306-207U0
F100B ETX	2005-06	REC93315-628U9	REC93315-430V5 REC93341-930V2		REC93315-43061	REC93315-425U7	REC93332-000U7		REC93306-208U0
F100D ETL	2005-06		REC93332-000U3		REC93317-325U0	REC93317-322V0			REC93306-207U0
115A	1984-87	REC93315-628U9	REC93315-430V5 REC93341-930V2		REC93315-43061	REC93315-425U7	REC93332-000U7		REC93306-208U0
115B	1988-95	REC93315-628U9	REC93315-430V5 REC93341-930V2		REC93315-43061	REC93315-425U7	REC93332-000U7		REC93306-208U0
115B	1996	REC93315-628U9	REC93315-430V5 REC93341-930V2		REC93315-43061	REC93315-425U7	REC93332-000U7		REC93306-208U0
115B ETO	1997-98	REC93315-628U9	REC93315-430V5 REC93341-930V2		REC93315-43061	REC93315-425U7	REC93332-000U7		REC93306-208U0
115B ETO	1999-00	REC93315-628U9	REC93315-430V5			REC93315-425U7	REC93332-000U7		REC93306-208U0
115B ETOL	2001-02	REC93315-628U9	REC93315-430V5 REC93341-930V2		REC93315-43061	REC93315-425U7	REC93332-000U7		REC93306-208U0
115C	1990-95	REC93315-628U9	REC93315-430V5 REC93341-930V2		REC93315-43061	REC93315-425U7	REC93332-000U7	REC93315-430V5	REC93306-208U0
115C ETO	2000	REC93315-628U9	REC93315-430V5 REC93341-930V2		REC93315-43061	REC93315-425U7	REC93332-000U7	REC93315-430V5	REC93306-208U0
115C ETOL	2001-06	REC93315-628U9	REC93315-430V5 REC93341-930V2		REC93315-43061	REC93315-425U7	REC93332-000U7	REC93315-430V5	REC93306-208U0
115C ETOX	2001-02	REC93315-628U9	REC93315-430V5 REC93341-930V2		REC93315-43061	REC93315-425U7	REC93332-000U7	REC93315-430V5	REC93306-208U0
F115A ET	2000	REC93315-628U9	REC93315-430V5 REC93341-930V2		REC93315-43061	REC93315-425U7	REC93332-000U7	REC93315-430V5	REC93306-208U0
F115A ETL	2001-06	REC93315-628U9	REC93315-430V5 REC93341-930V2		REC93315-43061	REC93315-425U7	REC93332-000U7	REC93315-430V5	REC93306-208U0
F115A ETX	2001-06	REC93315-628U9	REC93315-430V5 REC93341-930V2		REC93315-43061	REC93315-425U7	REC93332-000U7	REC93315-430V5	REC93306-208U0
FL115A ET	2000	REC93315-628U9	REC93315-430V5 REC93341-930V2		REC93315-43061	REC93315-425U7	REC93332-000U7	REC93315-430V5	REC93306-208U0
FL115A ETX	2001-06	REC93315-628U9	REC93315-430V5 REC93341-930V2		REC93315-43061	REC93315-425U7	REC93332-000U7	REC93315-430V5	REC93306-208U0
130B	1990-94	REC93315-628U9	REC93315-430V5 REC93341-930V2		REC93315-43061	REC93315-425U7	REC93332-000U7	REC93315-430V5	REC93306-208U0
130B ETO	2000	REC93315-628U9	REC93315-430V5 REC93341-930V2		REC93315-43061	REC93315-425U7	REC93332-000U7	REC93315-430V5	REC93306-208U0
130B ETOL	2001-06	REC93315-628U9	REC93315-430V5 REC93341-930V2		REC93315-43061	REC93315-425U7	REC93332-000U7	REC93315-430V5	REC93306-208U0
130B ETOX	2001	REC93315-628U9	REC93315-430V5 REC93341-930V2		REC93315-43061	REC93315-425U7	REC93332-000U7	REC93315-430V5	REC93306-208U0
L130B	1991-94	REC93315-628U9	REC93315-430V5 REC93341-930V2		REC93315-43061	REC93315-425U7	REC93332-000U7	REC93315-430V5	REC93306-208U0
L130B	1995-98		REC93315-430V5 REC93341-930V2		REC93315-43061	REC93315-425U7	REC93332-000U7		REC93306-208U0
L130B ETO	2000	REC93315-628U9	REC93315-430V5		REC93315-43061	REC93315-425U7	REC93332-000U7	REC93315-430V5	REC93306-208U0
L130B ETOX	2001	REC93315-628U9	REC93315-430V5 REC93341-930V2		REC93315-43061	REC93315-425U7	REC93332-000U7	REC93315-430V5	REC93306-208U0
140A	1984-87	REC93315-628U9	REC93315-430V5 REC93341-930V2		REC93315-43061	REC93315-425U7	REC93332-000U7		REC93306-208U0
140B	1988-89	REC93315-628U9	REC93315-430V5 REC93341-930V2		REC93315-43061	REC93315-425U7	REC93332-000U7		REC93306-208U0
L140B	1989	REC93315-628U9	REC93315-430V5 REC93341-930V2		REC93315-43061	REC93315-425U7	REC93332-000U7	REC93315-430V5	REC93306-208U0
150A	1984-89	REC93311-928U5	REC93315-430V5 REC93341-930V2		REC93315-43061	REC93315-425V3	REC93332-000V3 REC93390-000U2	REC93315-430V5	REC93306-209U0 REC93332-00048
150A ET	1998-00	REC93311-928U5	REC93315-430V5 REC93341-930V2		REC93315-43061	REC93315-425V3	REC93332-000V3		REC93306-209U0
150A ETO	1986-87				REC93315-43061		REC93390-000U2		REC93390-000U2
150A ETL	2001-02	REC93311-928U5	REC93315-430V5 REC93341-930V2		REC93315-43061	REC93315-425V3	REC93332-000V3		REC93306-209U0
150A ETX	2001-02	REC93311-928U5	REC93315-430V5 REC93341-930V2		REC93315-43061	REC93315-425V3	REC93332-000V3		REC93306-209U0
150C	1990-94	REC93311-928U5	REC93315-430V5 REC93341-930V2		REC93315-43061	REC93315-425V3	REC93332-000V3		REC93306-209U0
150F	1996-98	REC93311-928U5	REC93315-430V5 REC93341-930V2		REC93315-43061	REC93315-425V3	REC93390-000U2		REC93332-00048



1

2

3

4

5

6

7

8

LZ200T XRC	2004-06								REC93390-000U2	REC93390-000U2
LZ200T XRD	2005								REC93390-000U2	REC93390-000U2
Z200N ETO	2000	REC93311-928U5	REC93315-430V5 REC93341-930V2		REC93315-43061	REC93315-425V3	REC93332-000V3			REC93306-209U0 REC93332-00048
Z200N ETOL	2001-06	REC93311-928U5	REC93315-430V5 REC93341-930V2		REC93315-43061	REC93315-425V3	REC93332-000V3 REC93390-000U2			REC93306-209U0 REC93332-00048
Z200N ETOX	2001-06	REC93311-928U5	REC93315-430V5 REC93341-930V2		REC93315-43061	REC93315-425V3	REC93332-000V3			REC93306-209U0
Z200P ETOL	2003-06	REC93311-928U5	REC93315-430V5 REC93341-930V2		REC93315-43061	REC93315-425V3	REC93332-000V3			REC93306-209U0
220A	1984-86	REC93311-928U5	REC93315-430V5 REC93341-930V2		REC93315-43061	REC93315-425V3	REC93332-000V3			REC93306-209U0
225A	1987-89	REC93311-928U5	REC93315-430V5 REC93341-930V2		REC93315-43061	REC93315-425V3				REC93306-209U0
225B	1990-94	REC93311-928U5	REC93315-430V5 REC93341-930V2		REC93315-43061	REC93315-425V3	REC93332-000V3			REC93306-209U0
225B	1995	REC93311-928U5	REC93315-430V5			REC93315-425V3	REC93332-000V3			REC93306-209U0
225C	1994	REC93311-83280	REC93315-430V5		REC93315-43061					
225C	1995	REC93311-83280	REC93315-430V5							
225D	1996-98	REC93311-928U5	REC93315-430V5 REC93341-930V2		REC93315-43061	REC93315-425V3	REC93332-000V3			REC93306-209U0
225D ETO	2000	REC93311-928U5	REC93315-430V5 REC93341-930V2		REC93315-43061	REC93315-425V3	REC93332-000V3			REC93306-209U0
225D ETOL	2001-03	REC93311-928U5	REC93315-430V5 REC93341-930V2		REC93315-43061	REC93315-425V3	REC93332-000V3			REC93306-209U0
225D ETOX	2001-03	REC93311-928U5	REC93315-430V5 REC93341-930V2		REC93315-43061	REC93315-425V3	REC93332-000V3			REC93306-209U0
225G	1999	REC93311-83280	REC93315-430V5		REC93315-43061					
225G ETO	2000	REC93311-83280	REC93315-430V5		REC93315-43061					
225G ETOL	2001-03	REC93311-928U5	REC93315-430V5		REC93315-43061					
F225A ETU	2003-06		REC93315-430V5		REC93315-43061					REC93306-209U0 REC93332-00048
F225A ETX	2002-06	REC93311-83280	REC93315-430V5		REC93315-43061					REC93306-209U0 REC93332-00048
FL225A ETX	2002-06	REC93311-83280	REC93315-430V5		REC93315-43061					REC93306-209U0 REC93332-00048
L225C	1994	REC93311-83280	REC93315-430V5		REC93315-43061					
L225C	1995	REC93311-83280	REC93315-430V5							
250A	1990-94	REC93311-83280	REC93315-430V5		REC93315-43061					
250A	1995-98	REC93311-83280	REC93315-430V5							
250A ETO	2000	REC93311-83280	REC93315-430V5		REC93315-43061					
250A ETOX	2001-06	REC93311-83280	REC93315-430V5		REC93315-43061					
250B	1997-98	REC93311-83280	REC93315-430V5		REC93315-43061					
250B ETO	2000	REC93311-83280	REC93315-430V5		REC93315-43061					
250B ETOX	2001-03	REC93311-83280	REC93315-430V5		REC93315-43061					
250G ETOX	2006	REC93311-83280	REC93315-430V5		REC93315-43061					
F250A ETU	2006	REC93311-83280	REC93315-430V5							
F250A ETX	2006	REC93311-83280	REC93315-430V5							REC93306-209U0 REC93332-00048
FL250A ETU	2006	REC93311-83280	REC93315-430V5							REC93306-209U0 REC93332-00048
FL250 ETX	2006	REC93311-83280	REC93315-430V5							REC93306-209U0 REC93332-00048
L250A	1990-94	REC93311-83280	REC93315-430V5		REC93315-43061		REC93315-43061	REC93315-43061		
L250A	1995-98	REC93311-83280	REC93315-430V5							
L250A ETO	2000	REC93311-83280	REC93315-430V5		REC93315-43061					
L250A ETOX	2001-06	REC93311-83280	REC93315-430V5		REC93315-43061					
L250B	1997-98	REC93311-83280	REC93315-430V5		REC93315-43061					
L250B ETO	2000	REC93311-83280	REC93315-430V5		REC93315-43061					
L250B ETOX	2001-03	REC93311-83280	REC93315-430V5		REC93315-43061					
L250G ETOX	2006	REC93311-83280	REC93315-430V5		REC93315-43061					
LZ250D EOX	2003-06	REC93311-83280	REC93315-430V5		REC93315-43061					REC93306-209U0 REC93332-00048
Z250D ETOU	2003	REC93311-83280	REC93315-430V5		REC93315-43061					REC93306-209U0 REC93332-00048
Z250D ETOX	2003-06	REC93311-83280	REC93315-430V5		REC93315-43061					REC93306-209U0 REC93332-00048
Z250F ETOL	2003-06	REC93311-83280	REC93315-430V5		REC93315-43061					REC93306-209U0 REC93332-00048
LZ300A ETOX	2004-06	REC93311-83280	REC93315-430V5							REC93306-209U0 REC93332-00048
Z300A ETOU	2004-06	REC93311-83280	REC93315-430V5							REC93306-209U0 REC93332-00048
Z300A ETOX	2004-06	REC93311-83280	REC93315-430V5							REC93306-209U0 REC93332-00048

RETENES

SEAL OILS

REF	OEM
REC93101-11M14	93101-11M14
REC93101-13M11	93101-13M11
REC93101-17001	93101-17001



REF	OEM
REC93101-20M10	93101-20M10
REC93102-25M04	93102-25M04
REC93102-25M11	93102-25M11



SISTEMA DE PROPULSIÓN

PROPULSION SYSTEM

GUÍA DE RECAMBIOS DE HÉLICE

PROPELLER SPARE PARTS

	1	2	3	4	5
F2.5A, F4B, F5A, F6C	PAF4-03000025		PAF4-03000026	PAF4-03080000	PAGB/T91-1.6X12
F8C, F8F			REC90201-10M01	REC90171-10M01	REC91490-30025
F9.9J			REC90201-10M01	REC90171-10M01	REC91490-30025
F15C, F20B	REC6E7-45987-00		REC90201-10M01	REC90171-10M01	REC91490-30025
F25D	REC6L2-45987-00	REC689-45997-00	PAGB/T97.1-14	REC90171-14013-00	REC91490-30030
FT25F	REC663-45987-00			REC90171-16011	REC91490-30030
F30, F40F, F50H, F60F	REC663-45987-00	REC66T-45997-00	REC90389-22M01	REC90171-16011	REC91490-30030
FT50J, FT60G	REC688-45987-00	REC67F-45997-00	REC90389-25M00	REC90171-16011	REC91490-30030
F70A, F80B, F100D	REC688-45987-00	REC67F-45997-00	REC90389-25M00	REC90171-16011	REC91490-30030
F(L) 115A, F(L) 115B, F130A, F(L)150A, F(L)150D, F175A, F(L)200F	REC6E5-45987-00	REC688-45997-00		REC90171-18M04	REC91490-30025
F(L)225F, F(L)250D, F(L)300B (4.2L) V6		REC688-45997-00		REC90171-18M04	REC91490-30025

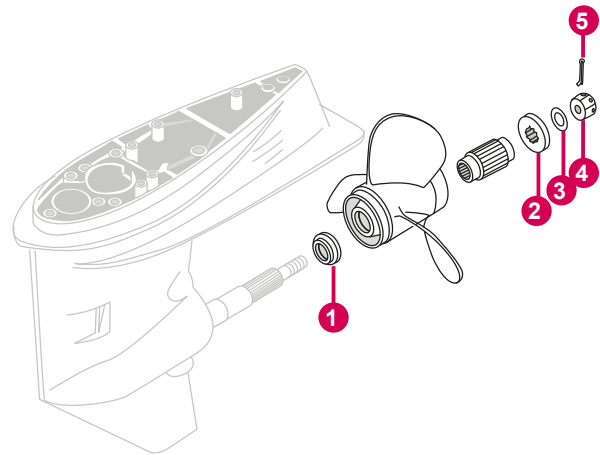

GUÍA DE HÉLICES CON NÚCLEO INTEGRADO

PROPELLERS APPLICATION WITH RUBBER HUB

	2T STROKES	4T STROKES	R.O. OEM	A	G	B	D	P	R	AL
2.5 - 6 HP	✓	✓	6L5-45943-00-EL 6E0-45943-01-EL	9		3	7 ^{1/4} 7 ^{1/2}	6 7	R R	PAF2.6-03010000 PAF4-03070000
9.9 15 T8 T9.9										
F9.9 (2000-07) F15 F20 Hight Thrust	✓	✓	63V-45943-10-00	8	2 1/2	3	9 ^{1/4}	11	R	PAF15-06090000

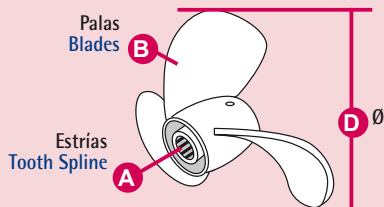

P Paso Pitch

R Rotación L (izquierda) R (derecha)
Rotation L (left) R (Right)

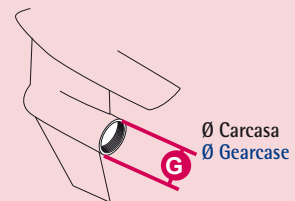

OEM --> REF

OEM	REF	OEM	REF	OEM	REF
308928	REC308928	925	61N-14198-00	REC61N-14198-00	1035
6771163500	REC677-11635-00	1029	61N-14301-04	REC61N-14301-04	870-877
6771163600	REC677-11636-00	1029	61N-24521-00	PAF15-07080002	859
137-11633-10	PAF20-05020003	957-986	61N-24560-00	PAF15-07080000	859
30X-12117-00	PAF15-07040006	957-961-963-967-969-971-975	61N-24563-00	REC61N-24563-10	859
30X-12117-00	PAF15-07050006	953	61N-24563-10	REC61N-24563-10	859
30X-12118-00	PAF15-07040007	953-957-961-963-967-969-971-975	61N-26311-00	REC61N-26311-00	908
3FV-13440-00, 10, 20, 30	REC3FV-13440-00	862-851-862	61N-44146-00	REC61N-44146-00	1111
3YF-12113-00	PAF20-05030004	957	61N-44311-01	PAF25-04050000	1055
50M-14355-00	RECS50M-14355-00	875	61N-44311-01	PAF25-04050001	929-930-931-922-1055-1105
51Y-12119-00	PAF166-010003	941-943-947-948-953-957-961-963-967-969-971-973-975-981	61N-44322-01	REC61N-44322-00	929-930-931-1055-1105
5GH-13440-00	PAF15-07010023	951	61N-44323-00	REC61N-44323-00	923-929-930-931-1055-1105
5GH-13440-00	PAF25-05000100	959	61N-44362-00	PAF25-04000017S	1055-1105
5GH-13440-00, 30, 70	RECS5GH-13440-00	862-951-959-965-977	61N-44362-10	PAF25-04000017	1055-1105
5GH-13440-10	RECS5GH-13440-00	975	61N-45127-00	PAF25-04000013	1055-1105
5GH-13440-20	RECS5GH-13440-60	963-971	61N-45214-00	PAF25-04000021	1053
5GH-13440-50	RECS5GH-13440-60	862-969-973	61N-45251-00	PAF15-06000004	1053
5GH-13440-60	RECS5GH-13440-60	862-955	61N-45251-01	REC61N-45251-01	933
60E-81950-00	REC60E-81950-00	889	61N-45251-01	REC61N-45251-01AL	933-1049-1101-1105
60R-12113-00	PAF6-04050003	947	61N-45311-02-4D	PAF25-04000001	1053
60R-E2414-A0	REC668-12414-A0	948	61N-45510-00	REC61N-45510-00	1055-1105-1132-1133
60R-G6241-00	REC68T-46241-00	948	61N-45510-10	REC61N-45510-10	1055
60V-12411-00	REC60V-12411-00	914-854-915	61N-45510-10	REC61N-45510-10	1105-1133-1132-1133
60V-13907-00	REC60V-13907-00	865	61N-45551-00	PAF25-04000005	1053
60V-43880-00	REC69J-43880-01	897	61N-45551-00	REC61N-45551-00	1105-1132-1133
60V-81800-00	REC60X-81800-00	886	61N-45560-00	REC61N-45560-10	1053
60V-81950-00	REC60V-81950-00	889	61N-45560-10	REC61N-45560-10	1105
60V-81960-00, 01, 02, 03, 04, 05	REC60V-81960-05	891	61N-45570-00	REC61N-45570-00	1105-1132-1133
60X-44315-A0	REC60X-44315-A0	1089-1130	61N-45587-00-10	PAF25-04000003-2	1055
60X-81800-00	REC60X-81800-00	886	61N-45587-00-11	PAF25-04000003-3	1055
61A-11325-00	REC61A-11325-00	933	61N-45587-00-12	PAF25-04000003-4	1055
61A-11325-00	REC61A-11325-00AL	933	61N-45587-00-13	PAF25-04000003-5	1055
61A-12414-A0	REC61A-12414-A0	915-997	61N-45587-00-14	PAF25-04000003-6	1055
61A-43880-00, 01	REC61A-43880-02	897	61N-45587-00-15	PAF25-04000003-7	1055
61A-44311-00	REC61A-44311-00	1129	61N-85540-00	REC61N-85540-00	892
61A-44311-01	REC61A-44311-00	1079-1083-1085-1089-1125-1127-1130	61N-85570-00	REC61N-85570-01	880
61A-44322-02	REC61A-44322-02	1079-1083-1085-1089-1125-1127-1129-1130-930-932-933	61N-85570-01	REC61N-85570-01	880
61A-45371-00	REC61A-45371-00AL	1087	61N-W0078-10	REC61N-W0078-11	926
61A-45527-00	REC61A-45527-00	1079-1083-1085-1125-1127-1129	61N-W0078-11	REC61N-W0078-11	926-1055-1105
61A-45538-00	REC61A-45538-00	1079-1083-1085-1125-1127-1129	61N-W0093-00	REC61N-W0093-00	873-995-877
61A-81800-00, 01	REC69W-81800-00	886	61P2-W0078-00	REC6P2-W0078-00	1089
61A-81941-00	REC61A-81941-00	889	61T-11193-A1	REC61T-11193-A0	995-1019
61A-81950-00, 01	REC61A-81950-01	889	61T-45113-A0	REC61T-45113-A0	1017
61A-81960-00, 01, 02, 03, 04	REC61A-81960-04	891	624-14485-00	PAT15-04010202	1001
61A-8258A-00-00	REC6G1-8258A-40-00	907	624-14485-00	REC624-14485-00	988-991-993-997-999-1003-1005-1007-1009
61A-W0078-01	REC61A-W0078-A1	929	624-24634-00	PAF4-04120103	858
61A-W0078-A1	REC61A-W0078-A1	1083-1129	626-14390-90	REC626-14390-90	874
61A-W0078-A3	REC61A-W0078-A1	1085	626-44365-01	REC626-44365-01	1099-1103
61B-8258A-00-00	REC61B-8258A-01	907	626-45316-09	REC626-45316-09	1049-1050-1099
61B-8258A-01	REC61B-8258A-01	907	626-45577-00	PAF15-06080006-1	1051-1101
61H-81800-00, 01	REC99999-03938	885	626-45577-00-01	PAF15-06080006-1	1049-1099
61N-11181-A1	REC61N-11181-00	995	626-45577-00-03	PAF15-06080006-3	1099
61N-11181-A2	REC61N-11181-00	1014	626-45577-00-05	PAF15-06080006-5	1099
61N-11515-00	REC61N-11515-00	995	626-45577-10	PAF15-06080006-2	1051
61N-11603-00	REC61N-11603-00	995-1026-1030	626-45577-20	PAF15-06080006-3	1051
61N-11604-00	REC61N-11604-00	995-1026	626-45577-30	PAF15-06080006-4	1051
61N-11605-00	REC61N-11605-00	995-1026	626-45577-40	PAF15-06080006-5	1051
61N-11631-00-95	REC61N-11631-00K	995-1026-1030	62P-14984-00	REC6P2-14984-00	867-856-857-864
61N-11635-00	REC61N-11635-00K	1026	62X-43880-00, 01, 09	REC62X-43880-09	895
61N-11636-00	REC61N-11636-00K	995-1026	62Y-11325-00	REC62Y-11325-00AL	965-971-973
			62Y-11372-01	PAF25-05010113	959
			62Y-11416-10	PAF25-05010302-2	961-967
			62Y-11654-00	PAF25-05020204	961-967
			62Y-12116-00	PAF25-05050003	957-961-963-967-969-971-975
			62Y-12121-00	PAF25-05050002	961-967-975
62Y-12158-00	PAF15-07040304	953-957-961-963-967-969-971-973-975			
62Y-12159-00	PAF15-07040303	957			
62Y-12231-00	PAF25-05050012	961-975			
62Y-12238-00	PAF25-05050009	961-975			
62Y-12279-00	PAF40-05040003	975			
62Y-12414-00	REC6H3-12414-A1	915-951-959-963-965-969-971-973-975			
62Y-12481-10	PAF25-05010113	971-973			
62Y-14392-00	REC61N-14392-00	874-877			
62Y-14485-00	PAF20-05040005	963			
62Y-14485-00	PAF40-05070002	965-969-971-975			
62Y-24410-00, 01, 02, 03, 04	PAF25-05130000	864			
62Y-43880-01, 02	REC62Y-43880-02	896			
62Y-44151-00	PAF60-04000003	1061-1065-1069			
62Y-44555-00	REC670-44555-00-94	913			
62Y-45127-00	PAF40-02000008	1032			
62Y-45571-00	PAF60-04000500	1069			
62Y-45631-00	PAF60-04020003	1065-1069			
62Y-46241-00	REC62Y-46241-00	975-1031			
62Y-82504-10	PAF15-07010100	879			
62Y-W0001-20,-21	REC62Y-W0001-22	920			
62Y-W0001-22	REC62Y-W0001-22	1064			
633-11634-00	REC663-11634-00	999-1027-1001-1027			
633-85518-00	REC663-85518-00	911			
634-11633-00	PAF15-07020006	951-986			
634-11633-00	REC634-11633-00	993-1026-1023			
63AH-61350-00	PAF20-07000100W	909			
63D-11181-A2	REC63D-11181-A1	1003-1014-1018			
63D-11193-A0	REC63D-11193-A0	1003-1019			
63D-11603-00	REC63D-11603-00	1003-1027			
63D-11605-00	REC63D-11605-00	1003-1027			
63D-44144-00	PA60-04000004	1063-1067-1071			
63D-44311-00	PAF60-04000401	922-931-1067-1071			
63D-44312-00	REC63D-44312-00	1059-1063-1067-1071-1073-1111			
63D-44316-00	REC63D-44316-00	1059-1063-1067-1071-1111			
63D-44322-00	REC63D-44322-00	1059-1063-1067-1071-1073-1111-930-931			
63D-44323-00	REC63D-44323-00	1063-1067-1071-923-930-931			
63D-44341-00	REC63D-44341-00	1059-1067-1111			
63D-45214-00	PAT40-04000022	1057-1061-1065-1069			
63D-45215-00	PAT40-04000023	1057-1061-1065-1069			
63D-45251-01	REC63D-45251-01	933			
63D-45251-01	REC63D-45251-01AL	933			
63D-45321-00	PAF60-04000101	1063-1067-1071			
63D-45344-00	PAF60-04000008	1071			
63D-45361-02-4D	REC63D-45361-02-4D	1057-1065-1111			
63D-45361-02-8D	PAF60-04030000	1065-1069			
63D-45361-02-8D	REC63D-45361-02-4D	1061-1069			
63D-45375-00	PAT40-04000014	1059-1063-1067-1071			
63D-45375-00	REC688-45375-00	1073-1077-1079			
63D-45577-10	PAT40-04060005-2	1057-1061-1065-1069			
63D-45577-20	PAT40-04060005-3	1057-1061-1065-1069			
63D-45577-30	PAT40-04060005-4	1057-1061-1065-1069			
63D-45577-40	PAT40-04060005-5	1057-1061-1065-1069			
63D-45611-00	PAF60-04020001	1061-1065-1069			
63D-45635-00	PAF60-04020005	1061-1065-1069			
63D-W0078-01	REC63D-W0078-01	927-1064-1068-852-853-930-931			

OEM	REF	
63P-11181-00	REC63P-11181-00	979-984-985
63P-11325-01	REC63P-11325-01	933
63P-11325-01	REC63P-11325-01AL	933-854-855-857-977
63P-11325-11	REC63P-11325-11	933
63P-11325-11	REC63P-11325-11AL	933-855-857-977
63P-11325-11	REC63P-11325-21	935-854-855
63P-11325-11	REC63P-11325-21AL	935
63P-11351-00	REC63P-11351-01	979
63P-11351-01	REC63P-11351-01	984
63P-12414-00	REC63P-12414-00	915-979-855
63P-13761-00/01	REC63P-13761-01	868-868-869
63P-13906-00	REC63P-13906-00	867-868-869
63P-13907-00, 01, 02, 03	REC63P-13907-03	864
63P-13915-00	REC63P-13915-00	862-854-855-856-857
63P-14984-00	REC63P-14984-00	867-855-864
63P-43880-10, 11, 12, 22	REC63P-43880-22	897
63P-45551-00	REC63P-45551-00	1081
63P-45987-00	REC6E5-45987-00	1079-1081-1127-1125-1144
63P-46241-00	REC63P-46241-00	979-1031
63P-81800-00	REC6BR-81800-02	886
63P-81950-00	REC63P-81950-00	889
63P-81960-00, 01, 02	REC63P-81960-02	891
63P-82380-00	REC63P-82380-00	878-868-869
63P-85886-00	REC13650-52G00	878
63V-11181-A1	REC63V-11181-A1	1014
63V-11181-A2	REC63V-11181-A1	993
63V-11412-00	REC63V-11412-00	993-1020
63V-11422-00	REC63V-11422-00	993-1020
63V-11432-00	REC63V-11432-00	993-1020
63V-11442-00	REC63V-11442-00	993-1020
63V-11445-00	REC63V-11445-00	993
63V-11515-02	REC63V-11515-02	993
63V-14126-00	REC63V-14126-00	871
63V-14301-00	REC63V-14301-00	870-877
63V-14984-00	REC63V-14984-00	871
63V-14985-00	REC63V-14985-00	876-877
63V-15396-01-CA	REC63V-15396-01-CA	993
63V-15713-00	PAF15-07130107	887
63V-15714-00	PAF15-07130201	888
63V-15716-00	PAF15-07130001	888
63V-15741-00	PAF15-07130202	887
63V-15767-00	PAF15-07130203	887
63V-15784-00	PAF15-07130204	887
63V-24411-00	REC63V-24411-00	865
63V-41111-00-1S	REC63V-41111-00-1S	993
63V-41112-A0	REC63V-41112-A0	917-993
63V-41113-00-1S	REC63V-41113-00-1S	993
63V-41133-A1	REC63V-41133-A1	1032
63V-43111-00-4D	PAF15-01010100	909
63V-43111-01-4D	PAF15-01010100	909
63V-43111-A2-4D	PAF15-01010100	909
63V-43112-00-4D	PAF15-01010200	909
63V-43112-01-4D	PAF15-01010200	909
63V-43131-00	PAF15-01010001	910
63V-43131-01	PAF15-01010001	910
63V-43131-10	PAF15-01010001	910
63V-43145-00	PAF15-01010007	910
63V-43311-00-4D	PAF15-01010301S	910
63V-43311-01-4D	PAF15-01010301S	910
63V-44150-00	PAF15-06030000S	1049-1101
63V-44150-10	PAF15-06030000L	1049-1101
63V-44301-00	REC63V-44301-00	1047-1049-1101-922-929-931
63V-44322-00	REC63V-44322-00	929-930-931-1047-1049-1051-1101
63V-44323-00	REC63V-44323-00	1049-1101-923-929-931
63V-44328-00	PAF15-06000014	1047-1049-1101
63V-44328-01	PAF15-06000014	1051
63V-44338-00	REC664-44338-00	1101

OEM	REF	
63V-44352-01	REC63V-44352-01	921-929-930-931-1049-1051-1101
63V-44361-01	REC63V-44361-01	1101
63V-44361-11	REC63V-44361-11	1101
63V-44365-10	PAF15-02000006	1047-1049-1101
63V-45113-A1	REC63V-45113-A1	993-1017-1018
63V-45215-00	PAF15-06000002	1051-1101-1047
63V-45300-00-4D	REC63V-45300-03-8D	1039
63V-45300-03-4D	REC63V-45300-03-8D	1039
63V-45300-03-8D	REC63V-45300-03-8D	1039
63V-45300-10-4D	REC63V-45300-13-8D	1039
63V-45300-13-4D	REC63V-45300-13-8D	1039
63V-45300-13-8D	REC63V-45300-13-8D	1039
63V-45311-01-4D	PAF15-06000001	1101
63V-45315-A0	REC63V-45315-A0	1049-1101
63V-45331-00-5B	REC63V-45331-00-5B	1049-1101
63V-45375-00	PAF15-06020005	1047-1049-1101-1050
63V-45510-00	PAF15-06040000S	1049
63V-45510-01	REC63V-45510-01	1101-1132-1131-1132
63V-45510-11	REC63V-45510-10	1049-1131-1132
63V-45510-11	REC63V-45510-11	1131-1132-1132
63V-45536-00	PAF15-06000006	1049-1050-1101
63V-45551-00	REC63V-45551-00	1049-1101
63V-45551-00-4D	PAF15-00000001	910
63V-45551-00	REC63V-45551-00	1051
63V-45943-10-00	PAF15-06090000	1144
63V-48501-00	REC63V-48501-00	903
63V-61350-00	PAF15-11020000W	909
63V-85520-00	REC63V-85520-00	882
63V-85533-00	REC63V-85533-00	879
63V-85540-00, 01, 02	REC63V-85540-00-01	892
63V-85570-00	REC63V-85570-00	880
63V-85580-01	REC63V-85580-01	883
63V-W0001-00	REC63V-W0001-00	993
63V-W0001-01	REC63V-W0001-00	1015
63V-W0078-00	REC63V-W0078-01	926
63V-W0078-01	REC63V-W0078-01	1049-1100
63V-W0093-00	REC63V-W0093-00	872-993-877
63V-W4311-00-4D	PAF15-01010200	909
63V-W4311-03-4D	PAF15-01010200	909
63V-WS431-B6-8D	PAF15-01010200	909
63W-13610-00	REC63W-13610-00	870-875
646-11633-00	REC646-11633-00	987
646-14623-A1	REC646-14623-A1	987-1033-1018
646-24251-01	PAF4-05000300	859
646-24251-01	REC35-80365M	859
646-24251-02	PAF4-05000300	859
646-24251-02	REC35-80365M	859-862
646-44322-00	REC646-44322-00	1093
646-44323-00	REC646-44322-00	1093
646-44323-00	REC646-44323-00	923-924-931
646-44352-01	REC646-44352-01	921-1093-931
646-44365-00	REC646-44365-00	1093
646-44366-01	REC646-44366-01	1093
646-45551-00	REC646-45551-00	1093-1131
646-45560-00	REC646-45560-00	1093-1131
647-11610-00	REC647-11610-00	991-1026-1030
647-11610-10	REC647-11610-10	991
647-14323-00	REC647-14323-00	875
647-14323-00	REC6G1-14985-00	876-877
647-14385-00	REC647-14385-00	876
647-14386-10	REC647-14386-10	875
647-44366-00	REC647-44366-00	1049-1096-1097-1101-929-931
647-45316-09	REC647-45316-09	1097
647-45551-00	REC647-45551-00	1097-1131
647-45560-00	REC647-45560-00	1097-1131
647-45570-01	REC647-45570-00	1097-1131
648-11633-00	REC648-11633-00	1003-1027-1023-1024-1023
648-13621-A1	REC648-13621-A0	1035
648-13645-A0	REC648-13645-A0	1034
648-14198-A0	REC648-14198-A0	1035

OEM	REF	
648-14384-01	REC648-14384-01-00	871
648-14385-00	REC648-14385-00	876
648-24411-00	REC648-24411-00	866
648-24434-01	REC648-24434-01	866
648-24435-02	REC648-24435-02	866
648-44146-00	REC648-44146-00	912
648-45633-00	REC648-45633-00	1049-1053-1099-1101-1103-1105-1107
648-45633-11	PAF25-04060000	1053
648-45633-11	REC648-45633-00	1051
648-45635-00	REC648-45635-00	1053-1103-1105
64D-11603-01	REC64D-11603-01	1011
64D-11603-02	REC64D-11603-01	1013-1029-1030
64D-11603-04	REC64D-11604-01	1029
64D-11603-05	REC64D-11605-01	1029
64D-11604-01	REC64D-11604-01	1011-1013
64D-11604-02	REC64D-11604-01	1013
64D-11605-01	REC64D-11605-01	1011
64D-11605-02	REC64D-11605-01	1013
64D-11631-02-90	REC64D-11631-00K	1013-1030-1031
64D-11642-02-90	REC64D-11642-00K	1013-1030-1031
64D-14384-01	REC64D-14384-1	872
64D-14394-00	REC64D-14394-00	875
64D-82570-31-00	REC64D-82570-31-00	905
64D-W0093-00	REC64D-W0093-00	874-1013
64E-43820-08, 09, 00	REC48630-96J03	898
64E-43821-00	REC48630-96J03	898
64E-43821-00, -05	REC48630-96J03	898
64E-43821-05	REC48630-96J03	898
64E-43821-08, 09, 00	REC48630-96J03	898
64E-43822-00	REC64E-43822-00	898
64E-4384J-00	REC64E-4384J-00	898
64E4382100	REC48630-96J03	898
64E4382105	REC48630-96J03	898
64J-24560-00	REC64J-24560-10	860
64J-24560-10	REC64J-24560-10	860
64J-81960-00	REC69J-81960-13	890
64J-81960-10	REC69J-81960-13	890
64J-W0001-20	REC64J-W0001-20	920
650-11370-00	REC650-11370-00	997
650-11370-01	REC650-11370-00	991-1001-1003-1005-1007-1009
650-11651-00	REC650-11651-04	993-1023
650-14385-00	REC6H4-14985-01	876
650-14485-03	REC650-14485-03	993
650-24378-00	PAF4-04010102	941-943-945-947-948-955-1001-1003-1007
650-24431-A0	REC650-24431-A0	866
650-44147-00	REC650-44147-00	912-1113-1117
650-45635-00	REC650-45635-00	1049-1051-1099-1101
655-12414-A1	REC655-12414-A1	915-995
656-11515-00	REC656-11515-00	1025
65E-85570-00	REC63V-85570-00	880
65F-42537-00	PAF15-01000001	911
65L-13761-00	REC65L-13761-00	868
65L-13907-00	REC67H-13907-00	865
65L-24563-00	REC65L-24563-00	860-855-856-861
65L-85886-00	REC13650-56B00	878
65N-W0078-A1	REC65N-W0078-A1	928-932
65W-08M87	PAGB/T5782-M8X35	959
65W-11168-00	PAF25-05010103	959
65W-11169-00	PAF25-05010108	959
65W-11181-30	PAF25-05040000	959-983-985
65W-11191-00-94	PAF25-05000005	959
65W-11351-00	REC65W-11351-10	959
65W-11351-10	REC65W-11351-10	984
65W-11356-00	PAF25-05000004	959
65W-11536-10	PAF25-05000021	961-967
65W-11537-01	PAF25-05050017	961
65W-11665-00	PAF25-05020310	961
65W-12151-00	PAF25-05050300	961
65W-12171-10	PAF25-05050200	961
65W-12228-00	PAGB/T5783-M6X20	959
65W-12228-00	PAGB/T5783-M6X20	959

OEM	REF		OEM	REF		OEM	REF	
65W-13286-00	PAF25-05010107	959	663-44367-00	PAT40-02000002	1059-1063-1067-1071-1073-1077-1117-1121	66M-11325-00	PAF15-07010008	951
65W-13300-00	PAF25-05050400	961	663-44551-02-8D	REC663-44551-02-8D	913	66M-11327-00-94	PAF15-07010011	951-959-965-971-973-975
65W-14384-00	REC65W-14384-00	871	663-45123-00	REC663-45123-00	1032	66M-11328-00	PAF15-07010009	849-850-851-852-853-951-959-965-971-973-975
65W-14457-10	PAF25-05080004	1032	663-45331-00-94	REC663-45331-00-94	1119-1134	66M-11328-00	PAGB/T97.1-8	961
65W-14901-12	PAF25-05070000	870	663-45375-00	REC663-45375-00	1117	66M-11351-10	PAF15-00000014	951-984
65W-15121-00	PAF25-05000007	959	663-45376-00	REC663-45376-00	1063-1079-1087-1117	66M-11356-00	PAF15-07050002	953
65W-15663-00	PAGBT3452.1-97.5X1.8	959	663-45376-00-94	REC663-45376-00	1059-1067-1071-1073-1077-1083	66M-11356-00	PAGB/T97.1-8	959
65W-24251-10	REC40145	859-849-851-861	663-45510-01	REC663-45510-01	1119-1134	66M-11357-00	PAF15-07010014	951
65W-41114-00	PAF25-05010111	917-959	663-45552-00	REC663-45552-00	1109-1115-1119	66M-11411-00	PAF15-07030000	951-985
65W-42138-00	PAF15-01030100	909	663-45557-00	REC663-45576-00	1115	66M-11416-00	PAF15-07010024	951
65W-43800-00-4D	PAT40-10000000	898	663-45567-01	PAT40-04000004-1	1057-1061-1065-1069	66M-11536-10	PAF15-07030003	953
65W-43800-01-4D	PAT40-10000000	898	663-45567-01-10	PAT40-04000004-1	1115	66M-11537-00-94	PAF15-07040018	953
65W-43800-02-4D	PAT40-10000000	898	663-45567-01-30	PAT40-04000004-5	1115	66M-11631-00-96	PAF15-07020001	951-986
65W-43800-03-4D	PAT40-10000000	898	663-45567-40	PAT40-04000004-5	1057-1061-1065-1069	66M-11650-00	PAF15-07020100	951
65W-43800-20-4D	PAT40-10000000	898	663-45587-01	PAT40-04000003-1	1059-1063-1067-1071	66M-12111-00	PAF15-07040001	953
65W-43800-21-4D	PAT40-10000000	898	663-45587-01-10	PAT40-04000003-1	1117	66M-12113-00	PAF15-07040005	953
65W-43800-22-8D	PAT40-10000000	898	663-45587-01-12	PAT40-04000003-2	1117	66M-12116-00	PAF15-07040004	953
65W-43800-23-8D	PAT40-10000000	898	663-45587-01-15	PAT40-04000003-3	1117	66M-12121-00	PAF15-07040002	953
65W-43880-00, 01	PAT40-10020500	895	663-45587-01-30	PAT40-04000003-3	1117	66M-12151-10	PAF15-07040301	953
65W-44150-00	PAF25-04030000S	1055	663-45587-10	PAT40-04000003-2	1059-1063-1067-1071	66M-12170-00	PAF15-07040200	953
65W-44176-00	PAF25-04000012	1055	663-45587-20	PAT40-04000003-3	1059-1063-1067-1071	66M-12411-00	PAF15-07000031	914
65W-44328-00	PAF25-04000016	1055	663-45587-00	PAT40-04000003-5	1059-1063-1067-1071	66M-12411-01	PAF15-07000031	914-947-948-951
65W-45300-00-4D	PAF25-04090000S	1053	663-45631-01	REC663-45631-00	1109-1113-1115-1119-1133-1134	66M-12535-00	PAF15-07010012	951-959-965-971-973-975
65W-45300-01-4D	PAF25-04090000L	1038-1053	663-45631-01	REC663-45631-00	1109-1113-1115-1119-1133-1134	66M-13300-10	PAF15-07040500	953
65W-45300-01-4D	PAF25-04090000S	1038	663-45633-00	REC663-45633-00	1109-1111-1113-1115-1119-1133-1134	66M-13329-10	PAF15-07040016	953
65W-45331-00-5B	PAF25-04000008	1055	663-45634-00	REC663-45634-00	1061-1065-1069-1109-1111-1119-1113-1115-1119	66M-14301-00	PAF15-07090000	870
65W-46241-00	REC65W-46241-00	961-967-1031	663-45987-00	REC663-45987-00	1057-1061-1065-1069-1109-1111-1119-1113-1115	66M-14301-00	PAF15-07090000W	870
65W-48501-00	REC65W-48501-01	904	663-45987-02	REC663-45987-00	1057-1061-1065-1069-1109-1111-1119-1113-1115	66M-15100-02-1S	PAF15-07010000	951
65W-48501-01	REC65W-48501-01	904	663-48344-00	REC663-48344-00	1144	66M-24410-11	PAF15-07140000	863
65W-61350-00	REC65W-61350-00	904	663-85540-11, 15	REC663-85540-15	902	66M-41114-01	PAF15-07010018	849-917-951
65W-81800-00, 01, 02, 03	REC65W-81800-03	884	663-W0078-00	REC663-W0078-01	1069-1109-1113-1115-1119	66M-41138-00	PAF15-04010004	1032
65W-82504-00	PAF15-07010100	879	663-W0078-01	REC663-W0078-01	928-1119	66M-44361-00	PAF15-02000005S	1049
65W-82575-01	REC65W-82575-01	894	664-41114-A0	REC664-41114-A0	917	66M-44361-10	PAF15-02000005L	1049
65W-85570-01	PAF25-05120000	881	664-44338-00	REC664-44338-00	1047-1049-1051-1103-1103-1107-1109-1111	66M-44514-00-4D	PAF15-02010000	913
65W-85790-00	PAF25-05010201	879	664-45371-01	REC664-45371-01AL	1103-1107	66M-44551-00-4D	PAF15-00000001	910
65W-W0001-00	REC65W-W0001-00	985-985	664-45374-00	REC664-45374-00	1103-1107	66M-44557-00	PAF15-00000003	913
65W-W0093-02	REC8542561	873	664-45567-01	PAF15-06000010-1	1051	66M-45113-00	PAF15-00000005	1034
65W242511000	REC40155	859	664-45567-01-10	PAF15-06000010-1	1049-1101	66M-45115-10	PAF15-03000003	1032
661-41262-01	PAF15-07000016	876	664-45567-05	PAF15-06000010-1	1099	66M-45300-02-4D	PAF15-06100000S	1038-1049
661-41262-02	PAF15-07000016	876	664-45567-10	PAF15-06000010-2	1051	66M-45300-11-4D	PAF15-06100000L	1038-1049
662-44352-01	REC662-44352-01	921-1097	664-45567-12	PAF15-06000010-2	1099	66M-45371-00	REC66M-45371-00	933
663-11193-A0	REC663-11193-00	1005-1019	664-45567-20	PAF15-06000010-3	1051	66M-45371-00	REC66M-45371-00AL	849-933-1049
663-11561-00	REC663-11561-00	1005	664-45567-30	PAF15-06000010-5	1099	66M-46241-00	REC66M-46241-00	953-1031
663-11633-00	REC663-11633-00	1005-1009-1028-1024	664-45567-40	PAF15-06000010-5	1051	66M-46297-00	PAF15-07000024	953
663-12414-A0	REC663-12414-00	916-1005	664-45567-50	PAF15-06000010-6	1099	66M-48501-01	REC66M-48501-01	904
663-12416-00	REC663-12416-00	1001-1005	664-45567-60	PAF15-06000010-7	1051	66M-81800-00, 01, 02	PAF15-07150100W	884
663-13621-A0	REC663-13621-00	1035	664-45567-00	PAF15-06000010-7	1051	66M-85520-00	PAF15-07000300	882
663-13622-00	REC663-13622-00	1036	664-45567-00	PAF15-06000010-7	1051	66M-85533-00	PAF15-07000400	879
663-14198-A0	REC663-14198-00	1035	664-45567-00	PAF15-06000010-7	1051	66M-85540-10	PAF15-07000500	892
663-14483-A0	REC663-14483-A0	1035	664-45567-00	PAF15-06000010-7	1051	66M-85550-00	PAF15-07000000	883
663-15713-00	REC663-15713-10	887	664-45567-00	PAF15-06000010-7	1051	66M-85550-10	PAF15-07070100W	883
663-24411-00	REC663-24411-00	866	664-45567-00	PAF15-06000010-7	1051	66M-85570-00	PAF15-07000600	880
663-41114-A0	REC663-41114-00	918-1005	664-45567-00	PAF15-06000010-7	1051	66M-85570-00	REC689-81311-40	880
663-42138-00	REC663-42138-00	909	664-45567-00	PAF15-06000010-7	1051	66M-85580-00	PAF15-07000200	883
663-43118-01-4D	REC663-43118-01-4D	912	664-45567-00	PAF15-06000010-7	1051	66M-W0001-20	REC66M-W0001-20	919-1049
663-44144-01	REC663-44144-01	1119-1121	664-45567-00	PAF15-06000010-7	1051	66M-W0093-01	REC66M-W0093-01	872
663-44151-00	REC663-44151-00	1119-1121	664-45631-01	REC664-45631-01	1103	66N-11603-00	REC66N-11603-00	951-986
663-44311-02	REC663-44311-02	1109-1119	664-45631-02	PAF25-04060003	1053	66T-11181-A0	REC66T-11181-00	1015
663-44311-02-00	REC663-44311-02	922	664-45631-02	REC664-45631-00	1105-1132-1133	66T-11181-A2	REC66T-11181-00	999
663-44315-A0	REC663-44315-A0	931-1107-1109-1119	664-45987-00	REC664-45987-00	1103	66T-11193-A0	REC66T-11193-A0	999-1019
663-44316-A0	REC663-44316-A0	1107-1109-1119	664-81970-60, 61, 62	REC661-81970-62	890	66T-11412-00	REC66T-11412-00	999-1020
663-44322-00	REC663-44322-00	930-931-1107-1109-1119	665L-13915-00	REC65L-13915-00	861	66T-11432-00	REC66T-11432-00	999-1020
663-44323-00	REC663-44323-00	924-931-1107-1109-1119	667-41114-A0	REC66T-41114-A0	999	66T-11442-00	REC66T-11442-00	999-1020
663-44324-A0	REC663-44324-00	1107-1109-1119	667-45551-00	REC66T-45551-00	1061	66T-11603-00	REC66T-11603-00	999-1027-1030
663-44341-00	REC663-44311-02	1119	667-45571-00	REC66T-45571-00	1061-1057-1111-1133-1134	66T-11604-00	REC66T-11604-00	999-1027
		930-931-932-1059-1063-1067-1071-1073-1077-1085-1107-1109-1111-1113-1117-1119-1121-1123-1129	667-45997-00	REC66T-45997-00	1069	66T-11605-00	REC66T-11605-00	999-1027
663-44366-00	REC663-44366-00		66K-13907-00	REC67H-13907-00	865	66T-11631-01-93	REC66T-11631-01K	999-1027-1030
			66K-13915-00	REC66K-13915-00	861	66T-11635-01	REC66T-11635-01K	999-1027
			66M-11111-01-1S	PAF15-07040000	953	66T-11636-01	REC66T-11636-01K	999-1027
			66M-11168-001S	PAF15-07010200	951	66T-11681-00	REC66T-11681-00	999-1023-1024
			66M-11181-10	PAF15-07000100	953-983-985	66T-14301-60	REC66T-14301-60	870-877
			66M-11191-00-1S	PAF15-07050001	953	66T-14384-01	REC66T-14384-01	871

OEM	REF		OEM	REF		OEM	REF	
66T-14536-01	REC66T-14536-01	871	676-45251-00	REC676-45251-00AL	999-1001	67D-12111-00	PAF4-04080005	943
66T-14992-00	REC66T-14992-00	875	676-45314-00	REC676-45314-00	1113	67D-12121-00	PAF4-04080006	943-948
66T-15713-00	REC66T-15713-00	887	676-45361-01-94	REC676-45361-00	1113-1134	67D-12151-00	PA166F-010009	941-943-947
66T-26301-00	REC66T-26301-00	908	676-45501-10	REC676-45501-10	1113-1134-1133	67D-12154-00	PAF4-04000015	943
66T-41114-A0	REC66T-41114-A0	918	676-45587-00-70	REC676-45587-00	1113	67D-12157-00	PA166F-010008	941-943-947
66T-41133-A0	REC66T-41133-A1	1032	676-45587-00-75	REC676-45587-00-75	1113	67D-14301-03	PAF4-04140000	869
66T-44311-00	PAT40-04000201	922-1059-1063	676-45587-00-80	REC676-45587-00-80	1113	67D-24410-03	PAF4-04090000	863
66T-44323-00	REC66T-44323-00	924-930-1059-1111	676-45635-00	REC676-45635-00	1109-1113-1115	67D-24610-00	PAF4-04120100	858
66T-44514-00-4D	REC66T-44514-00-4D	913	676-81800-10	REC99999-03249	885	67D-24610-02	PAF4-04120100	858
66T-45113-A0	REC66T-45113-A0	1017	676-81970-00	REC661-81970-62	890	67D-24610-03	PAF4-04120100	858
66T-45113-A00	REC66T-45113-A0	999	677-11181-A1	REC677-11181-A0	991-1014-1018	67D-24610-04	PAF4-04120100	858
66T-45114-A0	REC66T-45114-A0	1034	677-11631-00-97	REC677-11631-00K	991-1026-1030	67D-44366-00	PAF4-03000021	1043-1045
66T-45300-10-4D	PAF40-04000000L	1039	677-11635-00	REC677-11635-00K	991-1026	67D-45113-A0	PAF4-00000006	943-984-985
66T-45311-13-8D	PAF40-04000000L	1039	677-11636-00	REC677-11636-00K	991-1026	67D-45560-00	PAF4-03010000	1043-1045-1131
66T-45321-00	PAT40-04000007	1059	677-13621-A1	REC677-13621-00	1035	67D-45570-00	PAF4-03040000	1043-1045-1131
66T-45344-01	PAT40-04000009	1059-1063-1067	677-14198-A1	REC677-14198-A1	1034	67D-45631-01	PAF4-03030002	1043-1045
66T-45501-01	REC66T-45501-01	1111-1133	677-14227-00	REC677-14227-00	871	67D-45635-00	PAF4-03000008	1043-1045
66T-45501-11	REC66T-45501-10	1111-1133-1134	677-14343-68	REC677-14343-68	874	67D-85640-00	PAF4-04000038	882
66T-45551-00	REC66T-45551-00	1057-1111	677-14384-01	REC677-14384-01	871	67D-W0093-00	REC67D-W0093-00	872
66T-45560-01	REC66T-45560-00	1057-1061-1111-1133-1134	677-15741-01	REC677-15741-01	887	67F-11181-02	REC67F-11181-03	977
66T-45611-00	REC66T-45611-00	1057-1111-1133-1134	677-24411-02	REC677-24411-02	866	67F-11181-03	REC67F-11181-03	983
66T-45631-00	REC66T-45631-00	1057-1111-1133-1134	677-24434-02	REC677-24434-02	1034	67F-11325-01	REC67F-11325-01AL	979-981
66T-45635-00	REC66T-45635-00	1057-1111	677-24435-01	REC677-24435-01	866	67F-11328-00	REC67F-11328-00	977-979-982
66T-45997-00	REC66T-45997-00	1057-1111-1115	677-24471-01	REC677-24471-01	865	67F-12411-00	REC67F-12411-01	914
66T-48501-02	REC66T-48501-02	903	677-26301-02	REC677-26301-02	908	67F-12411-01	REC67F-12411-01	914-977-979-981
66T-82105-00	REC66T-82105-J2	887	677-41112-A1	REC677-41112-A0	991	67F-14371-01	REC67F-14371-01	876
66T-82105-J2	REC66T-82105-J2	887	677-41114-A0	REC677-41114-A0	917	67F-24251-02	REC40165	859
66T-82575-01	REC66T-82575-01	894	677-41114-A1	REC677-41112-A0	991	67F-43880-00	REC67F-43880-00	896
66T-85520-00	REC66T-85520-00	882	677-45113-A0	REC677-45113-A0	991-1017-1018	67F-44311-00	REC67F-44311-01	1077-922-930
66T-85533-00	REC66T-85533-00	879	677-W0093-00	REC677-W0093-00	872	67F-44322-00	REC67F-44322-00	1077-930
66T-85540-01	REC66T-85540-00-01	893	679-14923-00	REC679-14923-00	875	67F-44323-00	REC67F-44323-00	924-1077-930
66T-85570-00	REC66T-85570-00	881	679-14966-00	REC676-14966-00	876	67F-44352-00	REC67F-44352-00	921-930-1077
66T-85580-00	REC66T-85580-00	883	679-44150-00	REC679-44150-00	1117			852-853-937-1073-1075-1121-1123
66T-W0001-01	REC66T-W0001-01	999-1016-1018	679-44150-10	REC679-44150-10	1117	67F-45371-00	REC67F-45371-00AL	1073-1075-1121-1123
66T-W0001-20	REC66T-W0001-20	920-1111	679-44152-00	REC679-44152-00	1117	67F-45560-00	REC67F-45560-00	1075-1134
66T-W0078-00	REC66T-W0078-00	1056-1111	679-44316-A0	REC679-44316-A0	1117	67F-45576-00	REC67F-45576-00	1073-1075
66T-W0078-01	REC66T-W0078-00	928	679-44341-00-94	REC679-44341-00	1117	67F-45611-01	REC67F-45611-01	1073-1075-1135
66T-W0093-01	REC66T-W0093-01	873-999-877	679-44514-00-94	REC679-44514-00-94	913	67F-45997-00	REC67F-45997-00	1073-1075-1121-1144
670-44514-00	REC670-44514-00	913	679-45251-00	REC679-45251-00	935	67F-46241-00	REC67F-46241-00	977-1031
670-45997-02	REC670-45997-00	1109-1119	679-45251-00AL	REC679-45251-00AL	935	67F-81800-01, 02, 03, 04	REC67F-81800-04	885
676-11181-A2	REC676-11181-01	1015-1018	679-45315-A1	REC679-45315-A1	1115	67F-81960-00	REC67F-81960-12	891
676-11325-00	REC676-11325-00	935	679-45321-02	REC679-45321-02	1115	67F-85570-00	REC67F-85570-00	881
676-11325-00	REC676-11325-00AL	935-991-999-1001	679-45331-00-94	REC679-45331-00	1115	67F-W0078-00	REC67F-W0078-00	928-930-1074-853-854
676-11372-00	PAF15-04000005	941-947-949-951-963-981-991-993-995-997-999	679-45371-00	REC679-45371-00	935-1115-1119	67F-W0093-00	REC67F-W0093-00	874
676-12414-A0	REC676-12414-A0	999	679-45560-00	REC679-45560-00	1115-1133	67H-13907-00	REC67H-13907-00	865
676-12414-A1	REC676-12414-A0	915	679-45571-00	REC679-45571-00	1115	67H-43880-00	REC67H-43880-10	897
676-14186-00	REC676-14186-00	875	679-45611-01	REC679-45611-00	1109-1115-1133-1134	680-WE090-11-15	PAF4-04000000	943
676-14984-00	REC676-14984-00-00	872	679-W0078-00	REC679-W0078-A1	927-931	682-11325-00	REC682-11325-00	935
676-14985-01	REC676-14985-01	876	67C-11181-01	REC67C-11181-01	965-983-985	682-11325-00AL	REC682-11325-00AL	935-993
676-15471-00	REC676-15471-00	887	67C-11351-01	REC67C-11351-01	965-975-984-985	682-11351-A0	REC682-11351-A0	1017
676-41133-A0	REC676-41133-A0	1032	67C-11537-01	PAF40-05040006	967	682-11610-00	REC682-11610-01	1026
676-43160-00	REC676-43160-02	910	67C-11603-00	REC67C-11603-00	961-963-967-969-971-973-986	682-11610-01	REC682-11610-11	993-1026
676-43160-01	REC676-43160-02	910	67C-12111-00	PAF25-05050001	961-967	682-11610-21	REC682-11610-21	993-1026
676-43160-02	REC676-43160-02	910	67C-15312-00	PAF25-02010007	1034	682-11681-00	REC682-11681-00	993-1023
676-44311-00	REC676-44311-00	922-931-1113-1117	67C-41133-00	REC67C-41133-00	1032	682-12413-00-1S	REC682-12413-00-1S	916-993
676-44315-A0	REC676-44315-00	1117	67C-45123-00	PAF40-02000007	1032	682-12413-00-9M	REC682-12413-00-9M	916
676-44315-A1	REC676-44315-00	1113	67C-45251-00	REC67C-45251-00AL	850-851-852-853-937-1057-1061-1065-1069-1111	682-12414-A1	REC682-12414-A1	915-916-993
676-44316-A1	REC676-44316-A1	1113	67C-45371-00	REC67C-45371-00AL	850-851-852-853-937-1057-1061-1065-1069	682-13621-A0	REC682-13621-00	1034-1035
676-44322-00	REC676-44322-00	1117-931	67C-45501-00	PAF40-04010000S	1059-1063-1133-1134	682-41112-A1	REC682-41112-00	917
676-44323-00	REC676-44323-00-40	923-1117	67C-45501-10	PAF40-04010000L	1059-1063-1133-1134	682-41114-A1	REC682-41112-00	917
676-44323-40	REC676-44323-00-40	1113	67C-45633-00	PAT40-04050005	1065-1069	682-41133-A0	REC682-41133-A0	1032
676-44324-A0	REC676-44324-A0	1117	67C-81800-00, 01, 02	REC67C-81800-02	884	682-41237-50	REC682-41237-50	911
676-44324-A1	REC676-44324-A0	1113	67D-11181-A0	PAF4-04000014	943-983-985	682-42137-00	REC682-41237-00	911
676-44341-94	REC676-44341-00	1113	67D-11191-00	PAF4-04000018	943	682-44147-00	REC682-44147-00	1099-1107
676-44361-00	REC676-44361-00	1117	67D-11400-00	PAF4-04030000	943-985	682-44176-00	REC682-44176-00	1099
676-44361-10	REC676-44361-10	1117	67D-11650-00	PAF4-04020100	943	682-44312-00	REC682-44312-00	929-931-932-1099
676-44518-00	REC676-44518-00	913	67D-12111-00	PA166F-010001	941-948	682-44322-00	REC682-44322-00	929-931-932-1099-929-931
676-45114-A1	REC676-45114-A1	1034						932
676-45127-00	REC676-45127-00	1032				682-44323-00	REC682-44323-40	929-931-932-1099
676-45251-00	REC676-45251-00	999-1001				682-44328-00	REC682-44328-00	1099

OEM	REF		OEM	REF		OEM	REF	
682-44352-00	REC682-44352-01	1099	688-44316-A0	REC688-44316-00	1121	689-11181-A2	REC689-11181-00	1014-1018
682-44352-03	REC682-44352-01	921	688-44316-A0-00	REC688-44316-00	1123	689-11325-00	REC689-11325-00	935
682-44361-01	REC682-44361-01	1099	688-44322-00	REC688-44322-00	1121	689-11325-00	REC689-11325-00AL	935-995
682-44361-10	REC682-44361-10	1099	688-44322-00-00	REC688-44322-00	1123	689-11515-00	REC689-11515-00	1025
682-44365-00	REC682-44365-00	929-931-1099	688-44323-00-00	REC688-44323-00	924-1123	689-11610-01	REC689-11610-00	1027-1030
682-44514-01-94	REC682-44514-01-94	913	688-44323-40	REC688-44323-00	1121	689-11631-00-95	REC689-11631-00K	1027-1030
682-44555-30	PAF15-00000002	912	688-44324-A0	REC688-44324-00	1077-1121	689-11633-00	REC689-11633-00	995-1026-1027-1023
682-45113-02	REC682-45113-A0	1033-1018	688-44324-A0-00	REC688-44324-00	1123	689-11651-00	REC689-11651-00	995-1023-1024
682-45376-01	REC682-45376-01	1099	688-44341-01-94	REC688-44341-01	1121-1123	689-11681-01	REC689-11681-00	995-1023-1024
682-45631-00	REC682-45631-00	1049-1051-1099-1101-1131-1132	688-44352-03	REC688-44352-03	921-931-932-1121	689-15396-01-5B	REC689-15396-01-CA	995
682-82556-00	PAF4-01090401	894	688-44352-03-00	REC688-44352-03	1123	689-15755-00	REC689-15755-00	912
682-W0078-A1	REC682-W0078-A1	926-929-931-932-1098	688-44361-10	REC688-44361-10	1121	689-41112-A0	REC689-41112-A0	918
683-44361-01	REC683-44362-01	1099	688-44514-00	REC688-44514-00	913	689-41114-A0	REC689-41114-A0	918
683-44365-01	REC683-44365-01	1099	688-44555-00	REC688-44555-00	913	689-44311-03	REC689-44311-00	922-931-1103
683-44373-00	REC683-44373-00	1099	688-45113-A0	REC688-45113-A0	1009-1017-1018	689-44315-A0	REC689-44315-A0	1103
683-45315-00	REC683-45315-A0	1099	688-45114-A1	REC688-45114-A1	1034	689-44316-A0	REC689-44316-A0	1103
683-45361-00-EJ	REC683-45361-01-4D	1099	688-45123-00	REC688-45123-00	1033	689-44323-03	REC689-44323-00	1103-931
683-45361-02-4D	REC683-45361-01-4D	1049-1101	688-45214-02	REC688-45214-02	1079-1115	689-44324-A0	REC689-44324-A0	931-1103
683-45361-02-8D	PAF15-06080000	1051	688-45215-02	REC688-45215-02	1079-1115	689-44352-02	REC689-44352-02	921-931-1103
683-45361-02-8D	REC683-45361-01-4D	1051	688-45331-00-94	REC688-45331-00-94	1121-1123-1132-1134-1135	689-44366-00	REC689-44366-00	931-1103-1105
683-45611-00	REC683-45611-00	1049-1051-1099-1101-1131-1132	688-45341-00	REC688-45341-00	1053-1109-1125	689-45113-A1	REC61T-45113-A0	995
688-11111-02-15	REC688-11111-02-15	1009	688-45341-00-00	REC688-45341-00	1123	689-45501-10	REC689-45501-10	1103-1132-1133
688-11181-A1	REC688-11181-A1	1009	688-45341-00-00	REC688-45341-00	1057-1061-1065-1069-1073-1075-1079-1081-1085-1087-1089-1091-1105-1111-1113-1119-1121-1127	689-45551-00	REC689-45551-00	1103-1132-1133
688-11181-A2	REC688-11181-A1	1015	688-45375-00	REC688-45375-00	1083-1121	689-45560-00	REC689-45560-00	1103-1132-1133
688-11193-A1	REC688-11193-A1	1009-1019	688-45383-02	REC688-45383-01	1073-1075-1079-1121-1125	689-45570-00	REC689-45571-00-00	1103-1132-1133
688-11325-00	REC688-11325-00	935	688-45383-02-00	REC688-45383-01	1123	689-61350-02	REC689-61350-02	904
688-11325-00	REC688-11325-00AL	935-1003-1009	688-45384-00	REC688-45384-00	1121-1125	689-81800-10, 11, 12, 13	REC689-81800-13	884
688-11370-01	REC688-11370-00	1003-1007-1009	688-45384-00-00	REC688-45384-00	1123	689-W0078-04	REC689-W0078-A6	926-931
688-11411-01	REC688-11411-00	1009-1020	688-45384-02	REC688-45384-00	1073-1075-1079	689-W0078-A6	REC689-W0078-A6	926-931-1103
688-11603-A0	REC688-11603-A0	1005-1009-1028-1030-1031	688-45536-01	REC688-45536-01	1073-1077	689-W0093-02	REC689-W0093-02	872
688-11605-A0	REC688-11605-A0	1005-1009-1028	688-45551-01	REC688-45551-00	1121-1134-1135	689-W4432-02	REC689-W4432-01	931-1103
688-11610-02	REC688-11610-02	1028-1030-1031	688-45551-01-00	REC688-45551-00	1123	68D-11351-A0	PAF4-04000002	945-1033
688-11631-02-95	REC688-11631-02K	1028-1030	688-45560-00	REC688-45560-00	1121-1134-1135	68D-24610-10	PAF4-04120100	858
688-11631-03-94	REC688-11631-03K	1005-1009-1028	688-45560-00-00	REC688-45560-00	1123	68D-65300-03-4D	PAF4-03100005	1037
688-11631-81-96	REC688-11631-81K	1028-1030-1031	688-45567-01	PAT85-040000004-B	1073-1075	68D-65300-11-4D	PAF4-0310000L	1037
688-11634-00	REC688-11634-00	995-1005-1009-1026-1028	688-45571-01	REC688-45570-00	1121	68D-E1111-10-15	PAF4-04080101	943
688-11634-10	REC688-11634-00	1007	688-45571-00	REC688-45571-00	1121-1134-1135	68D-E1169-A0	PAF4-04000009	945
688-11635-03	REC688-11635-03K	1005-1028	688-45631-01	REC688-45631-00	1121-1134-1135	68D-E1193-A0	PAF4-04000017	943
688-11635-03	REC688-11636-03K	1005-1028	688-45633-00	REC688-45633-00	1073-1075-1121	68D-E1311-02-15	PAF4-04010100	945
688-11650-03	REC688-11650-03	1005-1009	688-45633-00-00	REC688-45633-00	1123			848-849-850-851-852-853-854-855-941-943-947
688-12411-10	REC6E5-12411-30	1009	688-45634-00	REC688-45634-00	1121	68D-E1325-00	PAF4-04070003	
688-12413-00-15	REC688-12413-00-15	916-1009	688-45635-00	REC688-45635-00	1119-1121	68D-E1603-00	REC68D-E1603-00	943-986
688-12414-A1	REC688-12414-A1	916-1009-1011-1013	688-45987-01	REC688-45987-00	1073-1075-1121	68D-E1631-00-96	PAF4-04020001	943
688-12416-00	REC688-12416-00	916-1009	688-45987-01-00	REC688-45987-00	1123-1144	68D-E1631-00-96	PAF4-04020200	943-986
688-13610-00	REC688-13610-00	875	688-45997-00	REC688-45997-00	1129	68D-E1633-00	PAF4-04020005	943-986
688-13621-A1	REC688-13621-A1	1036	688-45997-01	REC688-45997-00	1079-1081-1085-1087-1089-1125-1127	68D-E2113-00	PAF4-04080008	941-943
688-14198-A2	REC688-14198-A1	1036	688-45997-01-00	REC688-45997-00	1123-1144	68D-E2155-00	PAF4-04080009	943
688-14416-01	REC688-14416-01	1035	688-81800-10, 11, 12	REC688-81800-12	885	68D-E2170-00	PAF4-04040000	943
688-14483-A0	REC688-14483-A0	1035	688-82560-10	REC688-82560-10	879	68D-E2413-00-15	PAF4-04070000	947
688-14548-00	REC688-14548-00	875	688-82575-01	REC688-82575-01	894	68D-E2413-0015	PAF4-04070100	943
688-14947-00	REC688-14947-00	874	688-82586-11	REC688-82586-11	907	68D-E2414-A0	PAF4-04000011	848-915-941-943-947
688-24378-00	PAF15-05000011	951-959-963-965-975	688-82586-21	PAF15-13000100W	906	68D-E3102-00	PAF4-04050100	945
688-41112-A0	REC688-41112-A0	918-1009	688-82586-32	REC688-82586-32	907	68D-E5111-00-15	PAF4-04050200	945
688-41114-A0	REC688-41114-A0	919-1009	688-82586-51	REC688-82586-51	907	68D-E5362-00	PAF4-04000007	945
688-41133-00	REC688-41133-00	1033	688-8258A-10	REC688-8258A	906	68D-E5362-00	PAGB/T5783-M5X12	951
688-41134-A0	REC688-41134-00	1032	688-8258A-10-07	REC688-82586-11	907	68D-E5396-00-5B	PAF4-04060001	945-947
688-41211-00	REC688-41211-01	911	688-8258A-20	PAT85-08010100	906	68D-G2177-10	PAF4-01090300	911
688-41211-01	REC688-41211-01	911	688-8258A-30	REC688-8258A-30	906	68D-G4150-00	PAF4-03020000S	1043
688-41217-00	REC688-41217-00	877	688-8258A-30-07	REC688-82586-32	907	68D-G4150-10	PAF4-03020000L	1043
688-43160-01	REC688-43160-01	910	688-8258A-50-00	REC688-8258A-50-00	907	68D-G4311-01	PAF4-03000019	922-1043
688-43880-11	REC688-43880-11	896	688-8258A-50-07	REC688-82586-51	907	68D-G4315-A0	PAF4-03000018	1043
688-44120-11	REC688-44120-12	912	688-8258A-60	REC688-8258A-60	907	68D-G4328-00	PAF4-03000020	1043-1045
688-44120-12	REC688-44120-12	912	688-82590-00	REC688-82590-00	907	68D-G4360-00	PAF4-02040001S	1043
688-44120-22	REC688-44120-22	912	688-85510-00, 01	REC688-85510-01	894	68D-G4360-10	PAF4-02040001	1043
688-44311-01	REC688-44311-01	922-1121	688-85540-00	REC688-85540-00	893	68D-G4365-00	PAF4-02040002	1041-1043
688-44311-01-00	REC688-44311-01	1123	688-85540-16	REC688-85540-16	893	68D-G5300-00-4D	PAF4-0310000S	1043
688-44315-A0	REC688-44315-00	1077-1121	688-W0001-20	REC688-W0001-20	920	68D-G5300-10-4D	PAF4-0310000L	1043
688-44315-A0-00	REC688-44315-00	1123	688-W0001-22	REC688-W0001-22	920-1120-1123	68D-G5300-11-4D	PAF4-03000001	1043
688-44316-00	REC688-44316-00	1077	688-W0001-A0	REC688-W0001-A0	1016-1018	68D-G5315-A0	PAF4-03000011	1043-1045

OEM	REF		OEM	REF		OEM	REF	
68D-G5321-00	PAF4-03000012	1043-1045	696-14590-01	REC696-14590-01	874	69M-E5363-00	PAF15-07050004	939-948
68D-G5361-00-4D	PAF4-03050001	1043-1045	696-45113-00	REC696-45113-00	1005	69M-E5396-00	PAF2.6-04060001	939
68D-G5511-00	PAF4-03000004S	1045	696-45113-A0	REC696-45113-00	1017	69M-E5396-00-5B	PAF2.6-04060000	939
68D-G5511-10	PAF4-03000004L	1045	697-11181-A2	REC697-11181-A1	1005-1015-1018	69M-G2743-00	PAF2.6-04000008	939
68D-G5978-00	PAF4-030000025	1041-1043-1045	697-44352-00	REC6H3-44352-00	1119	69M-G4311-00	PAF2.6-03000014	848-922-929-1041
68F-11181-00	REC68F-11181-00	1015-1018	697-45114-A0	REC697-45114-00	1018-1034	69M-G4323-00	PAF2.6-03000010	923-1041-929
68F-13440-00	REC68F-13440-00	862	697-45384-00	REC697-45384-00	1109-1115-1119	69M-G5300-00-4D	PAF2.6-03020000S	1041
68F-13907-01	REC68F-13907-01	864	697-45551-00	REC697-45551-00	1119-1134	69M-G5300-01-4D	PAF2.6-03020000L	1041
68F-13915-00	REC68F-13915-00	861	697-45560-00	REC697-45560-00	1119-1134	69M-G5311-00-4D	PAF2.6-03000001	1041
68F-24563-00	REC68F-24563-00	860-861	697-45571-00	REC697-45570-00	1119	69M-G5315-A0	PAF2.6-03000007	1041
68F-24563-10	REC68F-24563-10	860-861	697-45611-00	REC697-45611-00	1119-1132-1134	69M-G5321-00-9A	PAF2.6-03000008	1041
68F-81800-00, 01, 03	REC6CJ-81800-01	886	697-81800-10, 11, 12	REC99999-03249	885	69M-G5361-00-4D	PAF2.6-03000300	1041
68F-8195A-00	REC68F-8195A-00	889	697-85570-00	REC697-85570-00	881	69M-G5361-00-4D	PAF2.6-03000301	1041
68F-83688-00	REC68F-83688-00	868-878	697-85570-11	REC697-85570-10	881	69M-G5511-00	PAF2.6-03000011S	1041
68N-81940-00	REC68N-8194A-00	889	697-W0001-A0	REC697-W0001-02	1016-1018	69M-G5511-10	PAF2.6-03000011L	1041
68R-48501-00-00	REC6DR-48501-03	902	69D-W0001-20	REC69D-W0001-20	920	69M-G5635-00	PAF2.6-03000020	1041
68T-11325-00	REC68T-11325-00AL	979	69G-45315-A0	PAF20-04000001	1050	69P-11412-00	REC6G0-11412-00	995-1020
68T-12116-00	PAF4-04080007	943-947-948	69G-45331-01-CA	PAF20-04010001	1050	69P-11422-00	REC6G0-11422-00	995-1020
68T-24251-00	REC68T-24251-00	859	69G-W0078-00	REC68T-W0078-00	926	69P-85541-09	REC69P-85541-09	882
68T-24251-01	REC68T-24251-00	859	69G-W0078-01	REC68T-W0078-00	926	69W-43880-00, 01	REC62Y-43880-02	896
68T-24410-00	REC68T-24410-00-00	863	69J-12119-00	REC69J-12119-00	979	69W-45300-00-4D	PAF60-04000000	1039
68T-24410-01	REC68T-24410-00-00	863	69J-13440-00, 01, 02, 03, 04	REC69J-13440-04	862	69W-45300-00-8D	PAF60-04000000	1039
68T-44323-00	REC68T-44323-00	923-929-1047-1051	69J-13440-01	REC35-822626Q15	979-981-855-856-857-862	69W-45300-01-8D	PAF60-04000000	1039
68T-44352-00	REC68T-44352-00	921-929-1047	69J-13761-00	REC69J-13761-00	868-869	69W-45300-04-8D	PAF60-04000000	1069
68T-44366-00	REC68T-44366-00	929-1047	69J-13906-00	REC69J-13906-00	867-869	69W-45301-00-8D	PAF60-04000001	1069
68T-45251-00	REC68T-45251-00AL	1047	69J-13907-00	REC69J-13907-03	864	69W-45501-00	PAF60-04010000	1071
68T-46241-00	REC68T-46241-00	1031	69J-13907-01	REC69J-13907-03	864	69W-45551-00	PAF60-04000002	1069
68T-85540-00	REC68T-85540-00	892	69J-13907-02	REC69J-13907-03	864	69W-45560-00	PAF60-04000600	1069
68T-W0078-00	REC68T-W0078-00	926-1047	69J-13907-03	REC69J-13907-03	864	69W-81800-00	REC69W-81800-00	886
68T-W0078-01	REC68T-W0078-00	926	69J-13907-04	REC69J-13907-03	864	69W-82575-00	REC69W-82575-00	894
68V-11325-01	REC68V-11325-01AL	977	69J-24410-00	REC69J-24410-02	864	6A0-14325-00	REC6A0-14325-00	875
68V-11325-02	REC68V-11325-02	935	69J-24410-01	REC69J-24410-02	864	6A0-24410-00	REC692-24410-00	863
68V-11325-02	REC68V-11325-02AL	935	69J-24410-02	REC69J-24410-02	864	6A0-24410-01	REC692-24410-00	863
68V-11351-00	REC68V-11351-00	977-984-985	69J-24502-00	REC69J-24502-00	860	6A0-24410-02	REC692-24410-00	863
68V-13761-00	REC68V-8A360-00	868	69J-41138-00	REC69J-41138-00	1033	6A0-24410-03	REC692-24410-00	863
68V-13907-00, 01, 02, 03, 04, 05, 06	REC68V-13907-00	865	69J-43880-00, 01	REC69J-43880-01	897	6A0-24410-03	REC692-24410-00	863
68V-13915-00	REC68V-13915-00	856-861	69J-45611-00	REC69J-45611-00	1085-1089-1136	6A0-24410-04	REC692-24410-00	863
68V-14984-00	REC68V-14984-00	856-864-865-867	69J-46241-00	REC69J-46241-00	1031	6A0-24410-04	REC692-24410-00	863
68V-15312-00	REC68V-15312-00	1034	69J-81800-00, 01	REC69J-81800-01	886	6A0-24410-05	REC692-24410-00	863
68V-24410-00	REC68V-24410-00	863	69J-81960-10, 11, 12, 13	REC69J-81960-13	891	6A0-82550-01	REC6A0-82550-01	894
68V-24560-00	REC6D8-24560-08	861	69J-85885-00	REC69J-85885-00	868-869-878	6A1-14301-03	REC6A1-14301-03	870-877
68V-24560-01	REC6D8-24560-08	861	69K-45611-00	REC69K-45611-00	1085-1089	6A1-14613-A0	REC6A1-14613-A0	987
68V-24563-00	REC68V-24563-00	859-852-861	69L-11646-00	REC69L-11646-00	1029	6A1-14613-A0, 00, 01	REC6A1-14613-A0	1033
68V-45501-10	REC68V-45501-10	1079	69L-45371-00	REC69L-45371-00	935	6A1-44361-00	REC6A1-44361-00	1093
68V-81800-00, 01, 02	REC68V-81800-03	885	69L-45371-00	REC69L-45371-00AL	935	6A1-85540-00, 01	REC6A1-85540-01	892
68V-8194A-00	REC68V-8194A-00	889	69L-81800-00	REC69W-81800-00	886	6A1-85570-00	REC6A1-85570-00	880
68V-81950-00	REC68V-81950-00	889	69M-11181-00	PAF2.6-04000001	941-983-985	6A1-W0078-01	REC6A1-W0078-01	925-931-1093
68V-81960-00	REC32800-38F10	890	69M-11193-A0	PAF2.6-04000005	941	6AE-43880-00, 01, 03, 04	REC67H-43880-10	897
68V-81960-10	REC68V-81960-10	891	69M-11351-A0	PAF2.6-04000004	939-1033	6AG-11181-00	REC6AG-11181-00	983
68V-82380-00	REC68V-82380-00	868-869-878	69M-11400-00	PAF2.6-04030000	941-985	6AG-11181-10	REC6AG-11181-00	955
68V-85885-00	REC68V-85885-00	868-878	69M-11650-00	PAF2.6-04020100	941	6AH-11111-10-1S	PAF20-05030100	955
68V-8A360-00	REC68V-8A360-00	868	69M-12154-00	PAF2.6-04000002	941	6AH-11168-00	PAF20-05040003	955
68V-W0078-00	REC68V-W0078-00	854-855-928-930-1078	69M-12170-01	PAF2.6-04000100	941	6AH-11169-00	PAF20-05040004	955
68V8196010	REC68V-81960-10	891	69M-12411-00	REC6AH-12411-00	914	6AH-11191-001S	PAF20-05040000	955
68W-43880-03	REC67H-43880-10	897	69M-12411-01	REC6AH-12411-00	914-941-943-949	6AH-11351-10	REC6AH-11351-10	955-984-985
692-14590-00	REC692-14590-01	874	69M-14301-21	PAF2.6-04000200	869	6AH-11356-00	PAF20-05040002	955
692-14590-01	REC692-14590-01	874	69M-15361-00	PAF2.6-04010102	939	6AH-11372-00	PAF20-05040005	955
692-14923-00	REC692-14923-00	875	69M-24575-00	PAF2.6-00000004	859	6AH-11411-00	PAF20-05020004	957-985
692-24410-00	REC692-24410-00	863	69M-44361-00	PAF2.6-02000003S	1041	6AH-11416-00	PAF20-05010003	957
692-24411-00	REC692-24411-00	865	69M-44361-10	PAF2.6-02000003L	1041	6AH-11536-00	PAF20-05000027	957
692-26301-00, 01, 02, 03	REC692-26301-03	908	69M-45113-A0	PAF2.6-00000003	941-984-985	6AH-11537-00	PAF20-05030012	957
692-41256-00	REC692-41256-00	877	69M-65300-01-4D	PAF2.6-03020000S	1037	6AH-11557-00	PAF20-05000028	957
692-44120-21	REC692-44120-22	912	69M-65300-11-4D	PAF2.6-03020000L	1037	6AH-11603-00	PAF20-05020100	957-986
692-44120-22	REC692-44120-22	912	69M-85640-00	PAF2.6-04000600	882	6AH-11631-00	PAF20-05020001	957-986
692-45300-12-4D	REC692-45300-16-8D	1039	69M-E1 603-01	REC69M-E1603-01	941-986	6AH-11650-10	PAF20-05030200	957
692-45300-13-4D	REC692-45300-16-8D	1039	69M-E1111-00-1S	PAF2.6-04040100	941	6AH-11654-00	PAF25-05020204	957
692-45300-14-4D	REC692-45300-16-8D	1039-1121	69M-E1191-00-1S	PAF2.6-04000006	941	6AH-12111-00	PAF20-05030001	957
692-45300-16-8D	REC692-45300-16-8D	1039	69M-E1311-00-1	PAF2.6-04010100	939	6AH-12121-10	PAF20-05030002	957
692-W0078-02	REC692-W0078-02	928-931-932-1120-1123	69M-E1631-01-96	PAF2.6-04020001	941-986	6AH-12151-00	PAF20-05030301	957
695-11181-A1	REC695-11181-00	1014-1018	69M-E1633-00	PAF2.6-04020005	941-986	6AH-12170-00	PAF20-05030200	957
695-85540-11, 12	REC695-85540-11	892	69M-E2155-00	PAF2.6-04040001	941	6AH-12279-00	PAF20-05030008	957
			69M-E3102-00	PAF2.6-04050100	939	6AH-12411-00	REC6AH-12411-00	914-955
			69M-E5111-00-1S	PAF2.6-04050001	939	6AH-12413-00-1S	PAF20-05000700	955

OEM	REF		OEM	REF		OEM	REF	
6AH-12414-00	PAF20-05000702	849-915-955	6AW-45619-00	REC6AW-45619-00	934	6CE-44311-00	REC6CE-44311-01	923
6AH-12481-00	PAF20-05000016	955	6AW-45619-00	REC6AW-45619-00	934-1091	6CE-44311-01	REC6CE-44311-01	923-1087
6AH-13300-00	PAF20-05030400	957	6AW-81800-00	REC6AW-81800-00	886	6CE-44315-00	REC6CE-44315-00	1087
6AH-13329-10	PAF20-05030010	957	6AW-8194A-00	REC6AW-8194A-00	889	6CE-44323-01	REC6CE-44323-01	1087
6AH-15100-00	PAF20-05010000	955	6AW-81950-00	REC6AW-81950-00	889	6CE-44352-00	REC6CE-44352-00	921
6AH-24410-00	PAF20-05050000	863	6AW-W0078-00	REC6AW-W0078-00	857-929-930-1091	6CE-44352-01	REC6CE-44352-00	1087
6AH-41113-01-1S	PAF20-05000600	955	6AW-W4624-00	REC6AW-W4624-00	1031	6CE-45373-00	REC6CE-45373-00	935-937
6AH-41114-00	PAF20-05000602	955	6B4-11193-A0	REC6B4-11193-A0	917	6CE-81800-00/01	REC6CE-81800-01	885
6AH-44150-00	PAF20-04020000S	1050	6B4-11351-A1	REC6B4-11351-A1	1017	6CE-W0078-00	REC6CE-W0078-01	929
6AH-44150-10	PAF20-04020000L	1050	6B4-14301-00	REC6B4-14301-00	869-877	6CE-W0078-01	REC6CE-W0078-01	857-929-1087
6AH-44311-00	PAF20-04040000	922-1051	6B4-26301-00	REC6B4-26301-00	908	6CJ-11181-00	REC6CJ-11181-00	973-983-985
6AH-44361-01	PAF20-02000101S	1051	6B4-85520-00	REC6B4-85520-00	882	6CJ-44323-00	REC6CJ-44323-00	1073
6AH-44361-11	PAF20-02000101L	1051	6B4-85540-01	REC6B4-85540-01	892	6CJ-44324-00	REC6CJ-44324-00	1073
6AH-44365-00	PAF20-02000007	1051	6B4-85570-01	REC6B4-85570-01	880	6CJ-81800-00	REC6CJ-81800-01	886
6AH-44368-00	PAF20-02000005	1051	6B4-85570-01	REC6B4-85570-01	880	6CJ-W0078-00	REC6CJ-W0078-00	853-927-930-1073
6AH-45251-00	REC6AH-45251-00	935	6B4-85580-00	REC6B4-85580-00	883	6D0-11642-00	REC6D0-11642-00	1029
6AH-45251-00	REC6AH-45251-00AL	935-1051	6BG-11181-00	REC6BG-11181-00	969-983-985	6D0-81800-00	REC6D0-81800-00	886
6AH-45300-00-4D	PAF20-04000000S	1038	6BG-13761-00	REC6BG-13761-00	868	6D0116310284	REC6D0-11631-00	1029
6AH-45300-00-8D	PAF20-04000000S	1038-1050	6BG-13910-00, 01, 02, 03	REC6BG-13910-03	865	6D1-45332-00-CA	REC6D1-45332-00-CA	1085
6AH-45300-10-4D	PAF20-04000000L	1038	6BG-13915-00	REC6BG-13915-00	851-860	6D3-81960-00	REC32800-38F10	890
6AH-45300-10-8D	PAF20-04000000L	1038-1050	6BG-41134-00	PAF2.6-04070200	877	6D8-13761-00	REC6D8-13761-00	868
6AH-45510-00	PAF20-04030000S	1051	6BG-41134-00	PAF40-02010007	1033	6D8-24410-10	REC6D8-24410-10	863
6AH-45510-10	PAF20-04030000L	1051	6BG-44341-00	PAT40-04040001	1071	6D8-24560-08	REC6D8-24560-08	861
6AH-46241-00	PAF20-05000003	957-1031	6BG-81800-00	REC6BG-81800-00	886	6D8-24560-09	REC6D8-24560-08	861
6AH-48501-00-00	REC6AH-48501-02	903	6BG-W0078-00	REC6BG-W0078-00	851-927-930-1060	6D8-24563-00	REC6D8-WS24A-00	860
6AH-81800-00, 01	PAF20-05000900W	884	6BG8180000	REC6BG-81800-00	886	6D8-41114-A0	REC67F-41114-A2	977
6AH-81960-00	PAT85-05030300	890	6BL-11181-00	REC6BL-11181-00	963-983-985	6D8-43880-00, 01, 09	REC6D8-43880-09	896
6AH-82560-00	PAT40-05000100	879	6BL-11325-00	REC6BL-11325-00	934	6D8-43880-00, 09	REC6D8-43880-09	896
6AH-85510-00	PAF20-05000200	894	6BL-11325-00	REC6BL-11325-00AL	850-934-963	6D8-44341-01	REC688-44341-01	1077
6AH-85540-00	PAF20-05000300	892	6BL-44391-00	PAF15-05000009	917	6D8-WS24A-00	REC6D8-WS24A-00	860
6AH-85550-00	PAF20-05000500	883	6BR-81800-00, 01	REC6BR-81800-02	886	6D9-12411-00	REC6D9-12411-00	854-914-915
6AH-85550-10	PAF20-05000500W	883	6BX-11181-00	PAF6-04000002	947-983	6D9-45551-00	REC6D9-45551-00	1075
6AH-85580-00	PAF20-05000100	883	6BX-11351-00	PAF6-04000001	947	6DA-12411-01	REC6DA-12411-01	856-914-915
6AH-W0078-00	REC6AH-W0078-00	926-1051	6BX-11356-00	PAF6-04000005	947	6DA-W4624-00	REC6DA-W4624-00	1031
6AH-W0078-01	REC6AH-W0078-00	926-1051	6BX-12111-00	PAF6-04050001	947	6DR-48501-00-00	REC6DR-48501-03	902
6AH-W009B-02-1S	PAF20-05000000	957	6BX-12154-00	PAF6-04000003	947	6E0-11193-A1	REC6E0-11193-A1	988
6AU-12121-00	PAF6-04050002	947	6BX-24360-00	REC6BX-24360-00	858	6E0-11631-00-98	REC6E0-11631-00-98K	988-1026-1030
6AU-48501-00-00	REC6DR-48501-03	902	6BX-44322-00	PAF6-03000002	929-1045	6E0-11651-01	REC6E0-11651-01	988-991-1023
6AW-11325-00	REC6AW-11325-00	935-857	6BX-45113-00	PAF6-00000001	947-984	6E0-24411-00	REC6E0-24411-00	865
6AW-11325-00	REC6AW-11325-00AL	935-982	6BX-E1111-00-1S	PAF6-04050100	947	6E0-24435-00	REC6E0-24435-00	866
6AW-1132L-00	REC6AW-1132L-00	857-935	6BX-E1168-00	PAF6-04010004	947	6E0-24471-00	REC6E0-24471-00	865
6AW-1132L-00	REC6AW-1132L-00AL	935	6BX-E1191-00-5B	PAF6-04000004	947	6E0-26301-01	REC6E0-26301-01	908
6AW-1132M-00	REC6AW-1132M-00	935	6BX-E2155-00	PAF6-04050004	947	6E0-41112-A1	REC6E0-41112-A1	917-988
6AW-1132M-00	REC6AW-1132M-00AL	935	6BX-E2170-00	PAF6-04030000	947	6E0-41114-A1	REC6E0-41114-A1	917-988
6AW-1132P-00	REC6AW-1132P-00	857-935	6BX-F4323-00	PAF6-04000020	947	6E0-43118-00	REC6E0-43118-01	912
6AW-1132P-00	REC6AW-1132P-00AL	935	6BX-G4150-00	PAF4-03020000S	1045	6E0-43118-01	REC6E0-43118-01	912
6AW-1132R-00	REC6AW-1132R-00	857-933	6BX-G4150-10	PAF4-03020000L	1045	6E0-44311-00	PAF4-03000019	1095
6AW-1132R-00	REC6AW-1132R-00AL	933	6BX-G4150-10	PAF4-03020000L	1045	6E0-44315-A0	PAF4-03000018	1095
6AW-1132S-00	REC6AW-1132S-00	933	6BX-G4315-01	PAF4-03000018	1045	6E0-44322-02	PAF4-03000017	1043
6AW-1132S-00	REC6AW-1132S-00AL	933	6BX-WG0078-00	REC6EE-W0078-01	925	6E0-44322-02	REC6E0-44322-02	929-931-1095
6AW-1132T-00	REC6AW-1132T-00	857-934	6C5-11654-00	PAF25-05020204	963-969-971-973-975	6E0-44323-00	PAF4-03000015	1095
6AW-1132T-00	REC6AW-1132T-00AL	934	6C5-13761-00	REC6C5-13761-00	868	6E0-44328-00	PAF4-03000020	1095
6AW-1132U-00	REC6AW-1132U-00	857-934	6C5-13907-00	REC866169T01	865	6E0-44352-00	PAF4-03060000	848-1043
6AW-1132U-00	REC6AW-1132U-00AL	934	6C5-13915-00	REC6C5-13915-00	860	6E0-44352-00	REC6E0-44352-00	921-929-931-1045-1095
6AW-12411-00	REC6AW-12411-00	914	6C5-14984-00	REC6C5-14984-00	852-853-865-867	6E0-44366-00	PAF4-03000021	1095
6AW-12411-00	REC6AW-12411-00	857-915-982	6C5-24251-00	REC6C5-24251-00	851-852-853-854-859	6E0-45113-A1	REC6E0-45113-A1	988
6AW-13761-00	REC6AW-13761-00	868	6C5-24410-00	REC6C5-24410-00	863	6E0-45251-12	REC6E0-45251-12	934
6AW-13907-00	REC6AW-13907-00	864	6C5-43800-11, 12	PAF60-06000000	898	6E0-45251-12	REC6E0-45251-12AL	849-850-851-852-853-934-1097
6AW-14984-00	REC6AW-14984-00	857-864-867	6C5-43880-00, 01	REC6C5-43880-01	896	6E0-45315-A0	PAF4-03000011	1095
6AW-4380R-00	REC48630-96J03	898	6C5-44361-00	PAF60-02000007	1071	6E0-45315-A0	REC6E0-45315-A0	925
6AW-43880-00, 01, 02	REC6AW-43880-22	897	6C5-46241-00	REC6C5-46241-00	963-969-971-973-1031	6E0-45316-09	PAF4-03000003	1043-1045
6AW-43880-00, 01, 02	REC6AW-43880-22	897	6C5-81800-00	REC6CJ-81800-01	886	6E0-45316-09	REC6E0-45316-00	1095
6AW-44311-00	REC6AW-44311-01	923-1091	6C5-82105-01	PAT85-05000023	887	6E0-45316-09	REC90340-08002	1096
6AW-44311-01	REC6AW-44311-01	923	6C5-85885-00	REC6C5-85885-00	868-878	6E0-45317-09	PAF4-03000002	1043-1045
6AW-44312-00	REC6AW-44312-00	1087-1091	6C9-81800-00	REC60X-81800-00	886	6E0-45317-09	REC6E0-45317-00	1095
6AW-44315-00	REC6AW-44315-00	1091	6CB-11181-00	REC6CB-11181-00	984-985	6E0-45321-01-5B	PAF4-03000012	1095
6AW-44322-00	REC6AW-44322-00	1087-1091	6CB-13016-00	REC6CB-13016-00	854-855-856-857-867	6E0-45361-01-4D	PAF4-03050001	1095
6AW-44323-00	REC6AW-44323-00	1091	6CB-14984-00	REC6CB-14984-00	854-855-856-857-867	6E0-45511-01	PAF4-03000004S	1043
6AW-44336-00	REC6AW-44336-00	1091	6CB-45611-00	REC6CB-45611-00	1087	6E0-45511-01	REC6E0-45511-01	1095-1131
6AW-44352-00	REC6AW-44352-00	921-1091	6CB-82310-00	REC6CB-82310-00	882	6E0-45511-11	PAF4-03000004L	1043
6AW-44365-00	REC6AW-44365-00	1087-1091	6CB-W4624-00	REC6CB-W4624-00	1031	6E0-45511-11	REC6E0-45511-11	1095-1131
6AW-45251-00	REC6AW-45251-00	934	6CE-12411-00	REC6CE-12411-00	857-914-915	6E0-45551-00	PAF4-03000007	1043
6AW-45251-00	REC6AW-45251-00AL	934						
6AW-45373-00	REC6AW-45373-00	934						
6AW-45373-00	REC6AW-45373-00AL	934-1091						

OEM	REF		OEM	REF		OEM	REF	
6E0-45551-00	REC6E0-45551-00	1095-1131	6E5-45332-00-CA	REC6E5-45332-00-94	1079	6EE-W0078-01	REC6EE-W0078-01	925
6E0-45560-00	REC6E0-45560-00	1095-1131			1125-1127-	6EG-G2138-00	PAF4-01090100	909
6E0-45570-00	REC6E0-45570-00	1095-1131	6E5-45344-00	REC6E5-45344-00	1083-1085-1089	6EK-44323-00	REC6E8V-44323-00	924-1079-930
6E0-45611-01	REC6E0-45611-01	1095	6E5-45371-01	REC6E5-45371-01	937-1125	6EK-W4624-00	PAF115-05000091	1031
6E0-45631-00	REC6E0-45631-00	1095-1131	6E5-45371-01	REC6E5-45371-01AL	1121-1125	6F5-11181-A1	REC6F5-11181-A2	1001
6E0-45943-01	PAF4-03070000	1045	6E5-45371-10	REC6E5-45371-10	934	6F5-11181-A2	REC6F5-11181-A2	1015
6E0-45943-01-EL	PAF4-03070000	1043-1144			854-855-	6F5-11193-A0	REC6G5-11193-A0	1013
6E0-45949-00	PAF2.6-03010000	1045	6E5-45371-10	REC6E5-45371-10AL	937-934-854	6F5-11515-00	REC6F5-11515-00	999-1001
6E0-85570-00	REC6E0-85570-00	880			855-937-179	6F5-11610-00	REC6F5-11610-00	1027
6E0-W0001-C1	REC6E0-W0001-C1	919-1043-1095	6E5-45536-00	REC6E5-45536-00	1079-1083-1125	6F5-11610-20	REC6F5-11610-20	1027
6E0-W0078-00	REC6E0-W0078-A2	927	6E5-45551-02	REC6E5-45551-00	1125-1135	6F5-11633-00	REC6F5-11633-00	999-1001-1027-1023-1024
6E0-W0078-01	REC6E0-W0078-A2	927	6E5-45560-01	REC6E5-45560-00	1125-1135	6F5-11650-11	REC6R5-11650-10	1013
6E0-W0078-02	REC6E0-W0078-A2	927	6E5-45571-01	REC6E5-45570-00	1125-1135	6F5-11651-00	REC6F5-11651-00	999-1001-1023-1024
6E0-W0078-A2	REC6E0-W0078-A2	927-1043-1095	6E5-45576-00	REC6E5-45576-00	1079-1125	6F5-11681-00	REC6F5-11681-00	1001-1024
6E3-14301-05	REC6E3-14301-05	869-877	6E5-45611-00	REC6E5-45611-00	1079	6F5-12411-00	REC6F5-12411-03	914
6E5-11181-A2	REC6E5-11181-A0	1011-1015-1018	6E5-45611-01	REC6E5-45611-00	1125	6F5-12411-01	REC6F5-12411-03	914
6E5-11193-A0	REC6E5-11193-A0	1011-1019	6E5-45631-01	REC6E5-45631-00	1125-1135	6F5-12411-02	REC6F5-12411-03	914-1001-1005
6E5-11325-00	PAF15-07010026	951			1079-1081-1087-1125-1127-1135-	6F5-12411-03	REC6F5-12411-03	914
6E5-11325-00	REC6E5-11325-00AL	955-981-1011-1013	6E5-45634-01	REC6E5-45634-01	1079-1081-1125	6F5-13621-A1	REC6F5-13621-A1	1035
6E5-11381-A1	REC6E5-11381-A1	1036	6E5-81800-10, 11, 12	REC6E5-81800-12	884	6F5-13645-A1	REC6F5-13645-A0	1035
6E5-11381-A2	REC6E5-11381-A1	1011-1013	6E5-81941-11	REC61A-81941-00	889	6F5-13646-A1	REC6F5-13646-A2	1035
6E5-11447-00	REC6E5-11447-00	1011-1013	6E5-81950-01	REC89-825096T01	888	6F5-14198-A1	REC6F5-14198-A1	1035
6E5-11610-02	REC6E5-11610-02	1029-1031	6E5-8195A-01	REC6E5-8195A-01	889	6F5-14323-01	REC6F5-14323-00	875
6E5-11634-00	REC6E5-11634-00	1029	6E5-8195C-01	REC6E5-8195A-01	889	6F5-14390-21	REC6F5-14390-21	874
6E5-12411-00	REC6E5-12411-02	914	6E5-82570-05	REC704-82570-12	905	6F5-14483-00	REC6F5-14483-00	871
6E5-12411-01	REC6E5-12411-02	914	6E5-85540-12, 11, 10	REC6E5-85540-12	893	6F5-15396-01-5B	REC6F5-15396-01-5B	1001
6E5-12411-02	REC6E5-12411-02	914	6E5-85570-10	REC6E5-85570-11	881	6F5-15713-00, 01	REC6E6T-15713-00	887
6E5-12411-10	REC6E5-12411-30	914	6E5-85570-11	REC6E5-85570-11	881	6F5-24563-00	REC6F5-24563-00	859-859-861
6E5-12411-20	REC6E5-12411-30	914	6E5-W0001-A2	REC6E5-W0001-A2	1016-1017-1018	6F5-26311-00	REC6F5-26311-00	908
6E5-12411-30	REC6E5-12411-30	914-993-1003-1011-1013	6E5-W0007-02	REC6N6-W0078-02	1125	6F5-41111-01-1S	REC6F5-41111-01-1S	1001
6E5-13621-A1	REC6E5-13621-A1	1036	6E5-W0093-07	REC6E5-W0093-07	874	6F5-41112-A0	REC6F5-41112-A0	918-1001
6E5-13645-A1	REC6E5-13645-A1-00	1036	6E5-W0093-08	REC6E5-W0093-08	874	6F5-41113-01-1S	REC6F5-41113-A0-1S	1001
6E5-14198-A2	REC6E5-14198-A2	1036	6E7-11111-01-1S	REC6E7-11111-01-1S	993	6F5-41114-A0	REC6F5-41114-A0	918-1001
6E5-14323-03	REC6E5-14323-03	875	6E7-11631-00	REC6E7-11631-00K	1026	6F5-44352-00	REC6F5-44352-00	921-1113
6E5-14328-01	REC6E5-14328-01	875	6E7-11631-00-97	REC6E7-11631-00K	993-1030	6F5-44352-002	REC6F5-44352-00	1117-931
6E5-14385-02	REC6E5-14385-02	876-877	6E7-11635-00	REC6E7-11635-00K	993-1026	6F5-45113-A0	REC6F5-45113-A0	1001-1017-1018
6E5-14386-01	REC6E5-14386-01	875	6E7-11636-00	REC6E7-11636-00K	993-1026	6F5-45312-01-4D	REC6F5-45312-00-4D	1113
6E5-14416-A1	REC6E5-14416-A1	1036	6E7-14227-00	REC6E7-14227-00	871	6F5-45551-00	REC6F5-45551-00	1113-1133-1134
6E5-14483-A1	REC6E5-14483-A1	1036	6E7-14385-00	REC6E7-14385-00	876-877	6F5-45560-00	REC6F5-45560-00	1113-1133-1134
6E5-14546-00	REC6E5-14546-00	874-877	6E7-44366-00	REC6E7-44366-00	1099	6F5-81800-10, 11	REC6J4-81800-01	884
6E5-24377-00	PAF15-07010006	949-951	6E7-45331-00-9M	REC6E7-45331-00-CA	1099	6F5-85540-22	REC6F5-85540-22	892
6E5-24410-01-00	REC6E5-24410-03	863	6E7-45501-00	REC6E7-45501-00	1099	6F5-W0001-C0	REC6F5-W0001-C0	920-1113
6E5-24411-00-00	REC6E5-24411-00	866	6E7-45501-10	REC6E7-45501-11	1099-1131-1132	6F5-W0078-00	REC679-W0078-A1	927
6E5-24434-02	REC6E5-24434-02	866	6E7-45536-00	REC6E7-45536-00	1099	6F5-W0078-A0	REC679-W0078-A1	1113
6E5-24435-00	REC6E5-24435-00	866	6E7-45551-00	REC6E7-45551-00	1099-1131-1132	6F6-11111-00-1S	REC6F6-11111-00-1S	1001
6E5-24471-00	REC6E5-24471-00	866	6E7-45560-00	REC6E7-45560-01	1099	6F6-11191-00-1S	REC6F6-11191-00-1S	1001
6E5-41112-A1	REC6E5-41112-A1	919-1011	6E7-45560-01	REC6E7-45560-01	1049-1051-1101	6F6-11193-A1	REC6F6-11193-A1	1001-1019
6E5-41134-A0	REC6E5-41134-A0	1033	6E7-45570-00	REC6E7-45570-00	1051	6F6-11400-01	REC6F6-11400-02	1001
6E5-41135-A0	REC6E5-41135-A0	1033	6E7-45571-00	REC6E7-45570-00	1049-1099-1101	6F6-11610-00	REC6F5-11610-00	1001
6E5-43880-00, 01, 02	REC6E8-43880-11	896	6E7-45587-01-30	PAF15-06000009	1099	6F6-11610-20	REC6F5-11610-20	1001
6E5-44311-00	REC61A-44311-00	923-930-932-933	6E7-45987-00	REC6E7-45987-00	1049-1099	6F6-11631-00-95	REC6F6-11631-00K	1001-1027
6E5-44311-00	REC61A-44311-00	930-932-933-1127	6E7-45987-01	PAF15-06000015	1101	6F6-11635-00	REC6F6-11635-00K	1001-1027
		1079-1083-1085-1125-	6E7-85570-19-00	REC6E7-85570-19	880	6F6-11636-00	REC6F6-11636-00	1001-1027
6E5-44315-A0	REC6E5-44315-A0	1127-1129 1083 1085 1125 1127 1129 932	6E7-W0001-00	REC6E7-W0001-A1	1015	6F6-13610-00	REC6F6-13610-00	875
			6E7-W0001-A1	REC6E7-W0001-A1	1015	6F6-14301-06	REC6F6-14301-06	869
6E5-44322-00	REC6E5-44322-00	1127-932-933	6E7-W0093-04	REC6E7-W0093-01	872	6F6-14341-00	REC6F6-14341-00	874
6E5-44323-00	REC6E5-44323-00-40	924-930-932-933-1125	6E8-14390-12	REC6E8-14390-12	874	6F6-14385-00	REC6F6-14385-00	876
		921-930-932-933-1079-1083-1085-1089-1125-1127-1129-1130	6E8-45251-02	REC6E8-45251-02	935	6F6-45611-00	REC6F6-45611-00	1113-1133-1134
6E5-44352-01	REC6E5-44352-01	1083-1127	6E8-45251-02	REC6E8-45251-02AL	935-1099	6F6-85530-01	REC6F6-85530-01	881
			6E8-45587-30	PAF15-06000009	1051	6F6-85540-01	REC6F6-85540-01	892
6E5-44365-00	REC6E5-44365-00	1083-1127	6E9-12413-00-1S	REC6E9-12413-00-1S	916-1001	6F6-W0001-02	REC6F6-W0001-02	1000-1016
6E5-44366-00	REC6E5-44366-00	1127	6E9-12414-A1	REC6E9-12414-A1	916-1001	6F6-W0093-00	REC6F6-W0093-00	873
6E5-45113-A0	REC6E5-45113-A2	1017-1018	6E9-81970-70	REC6G1-81970-62	890	6F8-11181-A1	REC6F8-11181-A0	987-1014-1018
6E5-45114-A0	REC6E5-45114-00	1034	6E9-82575-00	REC65W-82575-01	894	6FM-12411-00	REC6FM-12411-00	850-914-915
6E5-45251-00	REC6E5-45251-00	934	6EE-E5362-00	PAF4-04000036	945	6FP-12411-00	REC6FP-12411-00	854-914-915
6E5-45251-00	REC6E5-45251-00AL	934	6EE-E5396-00-CA	PAF4-04060000	945	6FP-81800-01	REC6FP-81800-01	886
6E5-45321-00	REC6E5-45321-00	1079-1083-1125-1127	6EE-F4251-00	REC68T-24251-00	859	6G0-82519-00	PAF6-04000009	947
6E5-45331-00-94	REC6E5-45331-00-94	1125-1127	6EE-G2177-00	PAF4-01090300	911	6G0-85540-11	REC6G0-85540-11	893
6E5-45331-00-95	REC6E5-45331-00-94	1135-1079-1083	6EE-G4311-00	REC6EE-G4311-00	923	6G1-11193-A1	REC6G1-11193-A1	917-989
6E5-45332-00-94	REC6E5-45332-00-94	1125	6EE-G4322-00	REC6EE-G4322-00	925	6G1-11610-00	REC6G1-11610-00	988-1026
			6EE-G4323-00	REC6EE-G4323-00	924	6G1-11633-00	REC6G1-11633-00	988-991-1026-1023
			6EE-G4366-01	REC6EE-G4366-01	917	6G1-11681-00	REC6G1-11681-00	988-989-991-1023
			6EE-W0078-00	REC6EE-W0078-01	925	6G1-14301-01	REC6G1-14301-01	869-877

OEM	REF		OEM	REF		OEM	REF	
6G1-14546-01	REC6G1-14546-00	874-877	6G8-11325-00	REC6G8-11325-00AL	849-937-948-949-955-963-969-971-973	6H3-45113-00	REC6H3-45113-00	1007-1018
6G1-15755-00	PAF4-04130100	887	6G8-11351-00	REC6G8-11351-A0	949-985	6H3-45114-A1	REC6H3-45114-A1	1033
6G1-15779-00	PAF4-04130100	887	6G8-12411-02	PAF15-07000031	959	6H3-45123-00	REC6H3-45123-00	1032
6G1-24304-02	REC6G1-24304-02	858	6G8-12411-03	PAF15-07000031	963-965-969-971-973-975	6H3-81800-10, 11	REC6H3-81800-11	885
6G1-24305-00, 01, 02	GS31075	858	6G8-12414-00	REC6G8-12414-A0	949	6H3-82510-00, 01, 02, 03	REC6H3-82510-03	888
6G1-24305-02-00	GS31075	858	6G8-12414-A0	REC6G8-12414-A0	915	6H3-85470-10	REC6H3-85570-10	881
6G1-24305-03-00	GS31075	858	6G8-13440-00	REC6G8-13440-00	862	6H3-85520-00	REC6H3-85520-00	882
6G1-24305-04-00	GS31075	858			949-953-955-959-963-965-969-971-973-975-977-979-981-982	6H3-W0001-02	REC6H3-W0001-02	1016-1018
6G1-24305-05-00	GS31075	858	6G8-15363-00	PAF15-07050004		6H3-W0001-22	REC6H3-W0001-22	919
6G1-24306-55	PAF15-09000000	858	6G8-44532-00	PAF2.6-04000009	939	6H3-W0078-00	REC6H3-W0078-02	852-853-928-930-931
6G1-24411-00	REC6G1-24411-00	865	6G8-45251-01	REC6G8-45251-01	935	6H3-W0093-02	REC6H3-W0093-02	873-877
6G1-24431-01	REC6E0-24434-00	866	6G8-45251-01	REC6G8-45251-01AL	935	6H4-11181-A2	REC6H4-11181-A2	1014-1018
6G1-24431-01	REC6G1-24431-01	866	6G8-46241-00	REC6G8-46241-00	1031	6H4-11193-00	REC6H4-11193-A1	1019
6G1-24471-00	REC6G1-24471-00	865	6G8-48501-03-00	REC6G8-48501-03-00	903	6H4-11610-00	REC6H4-11610-00-00	1027-1030
6G1-41112-A1	REC6G1-41112-A1	917-989	6G8-81800-10, 11	REC6J4-81800-01	884	6H4-11631-00-96	REC6H4-11631-00K	1027-1030
6G1-41114-A0	REC6G1-41114-A0	917-989	6G8-81870-00	REC6G8-81870-00	894	6H4-11636-01	REC6H4-11636-00K	1003-1027-1030
6G1-42138-00, 01	PAF4-01090100	909	6G8-81960-A1	REC6G8-81960-A1	890	6H4-11636-01	REC6H4-11636-01K	1003-1027
6G1-44315-A0	REC6G1-44315-A0	931-1096	6H0-81960-00	REC6H0-81960-00	891	6H4-11636-01	REC6H4-11636-01K	1003-1027
6G1-44322-00	REC6G1-44322-00	931-1096	6H1-11372-00	PAF15-04000005	955	6H4-11636-01	REC6H4-11636-01K	1003-1027
6G1-44323-00	REC6G1-44323-00	931-1096	6H1-11631-03-95	REC6G1-11631-03K	1028-1030-1031	6H4-14198-01	REC6H4-14198-01	1035
6G1-44328-00	REC6G1-44328-00	1096	6H1-14485-00	PAT15-04010202	939	6H4-14548-00	PAF25-05070019	875
6G1-44352-00	REC6G1-44352-00	921-931-1096	6H1-15359-01-94	REC6H1-15359-01-94	1009	6H4-14984-00	REC6H4-14984-00	871
6G1-45113-A1	REC6G1-45113-A1	989-1017	6H1-43800-13-4D	REC6H1-43800-17-8D	898	6H4-14985-00	REC6H4-14985-01	876
6G1-45214-00	PAF15-06000003	1047-1051-1101	6H1-43800-14-4D	REC6H1-43800-17-8D	898	6H4-14985-01	REC6H4-14985-01	876
6G1-45315-A0	REC6G1-45315-A0	1096	6H1-43800-15-4D	REC6H1-43800-17-8D	898	6H4-41114-A0	REC6H4-41114-A0	918-1003
6G1-45316-09	REC6G1-45316-09	1047	6H1-43800-16-4D	REC6H1-43800-17-8D	898	6H4-44352-00	REC6H4-44352-02	1067
6G1-45317-09	REC6G1-45317-09	1047	6H1-43800-17-8D	REC6H1-43800-17-8D	898			921-1055-1059-1063-1105-1107-1109-1111
6G1-45362-09	REC6G1-45362-09	1047	6H1-43880-00	REC6H1-43880-00	896	6H4-44352-02	REC6H4-44352-02	
6G1-45611-01	REC6G1-45611-01	1096-1131	6H1-43880-02	REC6H1-43880-02	895	6H4-45113-00	REC6H4-45113-00	1003
6G1-45631-00	REC6G1-45631-00	1096-1131	6H1-44144-00	REC6H1-44144-00	1123	6H4-45113-A0	REC6H4-45113-00	1017
6G1-81940-00	REC89-825096T01	888	6H1-45214-00	REC6H1-45214-00	1073-1075	6H4-45536-00	PAT40-04000002	1059-1063-1067-1071
6G1-81941-10	PAF15-05170300W	884-888	6H1-45215-00	REC6H1-45215-00	1073-1075	6H4-45551-00	REC6H4-45551-00	1109-1133-1134
6G1-81970-00, 60, 61, 62, A0	REC6G1-81970-62	890	6H1-45611-01-00	REC6H1-45611-00	1123-1134-1135	6H4-45560-00	REC6H4-45560-00	1109-1133-1134
6G1-W0001-C0	REC6G1-W0001-C1	919	6H1-45631-01-00	REC6H1-45631-01	1123	6H4-45571-00	REC6H4-45570-00	1109-1133-1134
6G1-W0078-00	REC6G1-W0078-A1	926	6H1-45634-02	REC6H1-45634-02	1123	6H4-81800-10, 11, 12	REC6H4-81800-12	884
6G1-W0078-01	REC6G1-W0078-A1	926	6H1-81950-00, 01	REC6H1-81950-01	889	6H4-W0078-00	REC6H4-W0078-00	927
6G1-W0078-A1	REC6G1-W0078-A1	926-1096	6H1-82563-11-00	REC6H1-82563-11-00	906	6H4-W0078-A0	REC6H4-W0078-00	1109
6G1-W0093-00	REC6G1-W0093-00	872-877	6H1-W0093-01	REC6H1-W0093-01-00	873	6H4-W0093-01	REC6H4-W0093-01-00	873
6G5-11181-A3	REC6G5-11181-A2	1013-1015-1018	6H1-W0093-10	REC6H1-W0093-10	873	6H4-W0093-03	REC6H4-W0093-03	873
6G5-11193-A1	REC6G5-11193-A0	1019	6H2-81960-10	REC6H2-81960-10	890	6H5-43880-00, 01, 02, 09	REC6H5-43880-09	895
6G5-11382-A1	REC6G5-11382-A1	919-1011-1013	6H2-85540-10, 11, 12, 13	REC6H2-85540-13	893	6H9-45551-00	REC6H9-45551-00	1115-1133
6G5-11631-00-93	REC6G5-11631-00K	1029-1031	6H2-W0001-20	REC6H2-W0001-20	920	6J8-11325-00	REC6J8-11325-00AL	995-997
6G5-11642-00-93	REC6G5-11642-00K	1029-1031	6H2-W0093-10	REC6H2-W0093-10	873	6J1-11610-00	REC6J1-11610-00	988
6G5-13645-A2	REC6G5-13645-A1	1036	6H3-11181-A2	REC6H3-11181-A0	1007-1014-1018	6J4-81800-00, 01	REC6J4-81800-01	884
6G5-14416-A1	REC6G5-14416-A1	1036	6H3-11193-A1	REC6H3-11193-A1	1007-1019	6J8-11181-A1	REC6J8-11181-A1	997
6G5-14483-A1	REC6G5-14483-01	1036	6H3-11631-01-96	REC6H3-11631-01K	1007-1026-1030	6J8-11181-A2	REC6J8-11181-A2	1014
6G5-41112-A1	REC6G5-41112-A1	919-1013	6H3-11633-00	REC6H3-11633-00	1007-1024-1026-1028	6J8-11631-02-97	REC6J8-11631-02	997-1027-1030
6G5-41114-A0	REC6G5-41114-A1	919-1013	6H3-11635-01	REC6H3-11635-01K	1007	6J8-12414-A0	REC6J8-12414-A0	1003
6G5-41134-A1	REC6G5-41134-A1	1033	6H3-11635-01	REC6H3-11635-01K	1026	6J8-24471-00	REC6J8-24471-00	866
6G5-41217-01	REC6G5-41217-00	877	6H3-11636-01	REC6H3-11636-01K	1007-1026	6J8-44311-00	REC6J8-44311-02	1107
6G5-43864-00	REC6G5-43864-00	898	6H3-12411-00	REC6H3-12411-10	914	6J8-45113-A0	REC6J8-45113-00	997-1017-1018
6G5-43880-00, 01, 02	REC6G5-43880-02	897	6H3-12411-01	REC6H3-12411-10	914	6J8-48501-00-00	REC6J8-48501-03-4D	903
6G5-44323-00	REC6G5-44323-00	1083-1085-1127-1129	6H3-12411-11	REC6H3-12411-10	914	6J8-48501-03-4D	REC6J8-48501-03-4D	903
6G5-44323-01	REC6G5-44323-00	924	6H3-12413-00-15	PAF15-07010021	965-975-1007	6J8-48501-11	REC6J8-48501-11	903
6G5-45113-A1	REC6G5-45113-A1	1011-1013	6H3-12413-00-9M	PAF15-07010021	959	6J8-48501-11-00	REC6J8-48501-11	903
6G5-45113-A2	REC6G5-45113-A1	1018	6H3-12413-00T5	PAF15-07010021	951	6J8-81960-00	PAF15-07060001	890
6G5-45114-A1	REC6G5-45114-A0	1034	6H3-12414-A1	REC6H3-12414-A1	915-1007	6J8-W0078-A1	REC6J8-W0078-A2	927
6G5-45383-01	REC6G5-45383-01	1081-1127	6H3-13621-A1	REC6H3-13621-A1	1036	6J9-45371-00	REC6J9-45371-00AL	1081
6G5-45384-00	REC6G5-45384-00	1081-1127	6H3-13622-A1	REC6H3-13622-A1	1035	6J8-W0078-C2	REC6J8-W0078-A2	1107
6G5-45501-21	REC6G5-45501-21	1127-1135-1136	6H3-14198-A1	REC6H3-14198-A1	1035	6J9-45611-01	REC6J9-45611-00	1081-1127-1135-1136
6G5-45551-01	REC6G5-45551-00	1127-1135-1136	6H3-14590-01	REC6H3-14590-00	874-877	6K1-11651-00	REC6K1-11651-00	1025
6G5-45560-01	REC6G5-45560-00	1127-1135-1136	6H3-41112-A0	REC6H3-41112-A0	918-1007	6K1-45371-00	REC6K1-45371-00	934
6G5-45571-02	REC6G5-45571-00	1127-1135-1136	6H3-41114-A0	REC6H3-41114-A0	918-1007	6K1-45371-00	REC6K1-45371-00AL	934
6G5-45576-10	REC6G5-45576-10	1081	6H3-41217-00	REC6H3-41217-00	877	6K1-45371-02	REC6K1-45371-02	934
6G5-45631-00	REC6G5-45631-00	1127-1135-1136	6H3-44311-00	REC6H3-44311-00	923	6K1-45371-02	REC6K1-45371-02AL	934-956
6G5-81960-A0	REC6G5-81960-A0	890	6H3-44323-00-00	REC6H3-44323-00	923-930-931	6K1-82570-00	REC6K1-82570-13	904
6G5-W0078-00	REC6G5-W0078-A1	928	6H3-44324-A0-00	REC6H3-44324-A0-00	925	6K1-82570-02	REC6K1-82570-13	904
6G5-W0078-01	REC6G5-W0078-A1	928	6H3-44352-00	REC6H3-44352-00	921-1071-1073	6K1-82570-03	REC6K1-82570-13	904
6G5-W0078-A1	REC6G5-W0078-A1	928-1127	6H3-44391-00	PAF15-05000009	917	6K1-82570-04	REC6K1-82570-13	904
6G8-11181-00	REC6G8-11181-A1	949	6H3-44391-01	PAF15-05000009	917	6K1-82570-05	REC6K1-82570-13	904
6G8-11181-A1	REC6G8-11181-A1	983						
6G8-11197-01	PAF20-05030009	971-973						
6G8-11197-A0	PAF20-05030009	955						

OEM	REF		OEM	REF		OEM	REF	
6K1-82570-06	REC6K1-82570-13	904	6N6-W0078-00	REC6N6-W0078-02	928	6X6-8258A-60	REC6X6-8258A-61	907
6K1-82570-07	REC6K1-82570-13	904	6N7-11411-00	REC6N7-11411-00	1011-1020	6X6-8258A-61	REC6X6-8258A-61	907
6K1-82570-08	REC6K1-82570-13	904	6N7-81800-00, 01, 10	REC99999-03938	885	6X6-8258A-71	REC6X6-8258A-71	907
6K1-82570-10	REC6K1-82570-13	904	6P2-13761-00	REC6P2-13761-00	868-869	6X6-8258A-81	REC6X6-8258A-81	907
6K1-82570-11	REC6K1-82570-13	904	6P2-13906-00	REC6P2-13906-00	867-869	6Y1-24268-00	PAF15-10000003	859
6K1-82570-12	REC6K1-82570-13	904	6P2-13907-00	REC6AW-13907-00	864	6Y1-24305-00, -01, -02	GS31075	858
6K1-82570-13	REC6K1-82570-13	904	6P2-24563-00	REC6P2-WS245-00	860	6Y1-24305-05-00	GS31074	858
6K1-82575-00-00	REC6K1-82575-01	905	6P2-44323-0	REC6P2-44323-00	924-1089-930-	6Y1-24305-05-00	GS31075	858
6K1-82575-01	REC6K1-82575-01	905	6P2-45501-00	REC6P2-45501-01	1089	6Y1-24305-06-00	GS31075	858
6K1-8258A-40-00	REC6K1-8258A-40-00	907	6P2-45501-10	REC6P2-45501-11	1089	6Y1-24305-06, -00	GS31074	858
6K5-11601-02	REC6K5-11601-02	1007-1026-1028-1030	6P2-46241-01	REC6P2-46241-02	981	6Y1-24306-55	PAF15-09000000	858
6K5-11601-12	REC6K5-11601-12	1007-1026-1028	6P2-46241-02	REC6P2-46241-02	1031	6Y8-83553-02	REC6Y8-83553-02	887
6K5-11601-22	REC6K5-11601-22	1007-1026-1028	6P2-81960-02, 03	REC6P2-81960-03	891	6YJ-24167-00	PAF15-10000002	858
6K5-11631-03-95	REC6K5-11631-03K	1028-1030	6P2-W0078-00	REC6P2-W0078-00	929	6YJ-24260-00	PAF15-10020000	859
6K5-11635-03	REC6K5-11635-03K	1028	6P2-WS245-00	REC6P2-WS245-00	860	6YJ-24260-10	PAF15-10020000	859
6K5-11636-03	REC6K5-11636-03K	1028	6P3-24563-00	REC6P3-WS24A-00	860	6YJ-24610-00	PAF15-10010000	858
6K5-14301-03 + 6K5-14302-03 + 6K5-14303-03	REC6K5-14301-03	870-877	6P3-24564-00	REC6P3-24564-00	860-855-856-857	6YJ-24610-01	PAF15-10010000	858
6K5-W0001-02	REC6K5-W0001-02	1016	6P3-WS24A-00	REC6P3-WS24A-00	860	6YL-24305-01-00	GS31074	858
6K7-11633-00	REC6K7-11633-00	1029-1024-1025	6P3-WS24A-01	REC6P3-WS24A-00	860	6YL-24305-01-00	GS31075	858
6K7-14483-00	REC6K7-14483-00	1036	6R0-44366-00	PAF4-03000021	1041	703-48152-00	PAF15-13020007W	908
6K7-81800-10	REC99999-03938	885	6R3-81960-10	REC6R3-81960-10	891	703-48203-12-00	REC703-48203-23	900
6K8-41122-A1	REC6K8-41122-A1	918-995	6R3-82105-J2-00	REC6R3-82105-J3	887	703-48203-23	REC703-48203-23	900
6K8-41124-A1	REC6K8-41124-A1	918-995	6R3-82105-J3	REC6R3-82105-J3	887	703-48205-10	REC703-48205-16	899
6L2-14384-00	REC6L2-14384-00-00	871	6R3-82105-J3	REC6R3-82105-J3	887	703-48205-11	PAT85-08010000W	899
6L2-14385-00	REC6L2-14385-00	876-877	6R3-82563-01	REC6R3-82563-01	895	703-48205-11	REC703-48205-16	899
6L2-14399-00	REC6L2-14399-00	871	6R3-82563-01	REC6R3-82563-01	895	703-48205-12	PAT85-08010000W	899
6L2-26301-00	REC6L2-26301-00	908	6R3-85570-01	REC6R3-85570-01	881	703-48205-12	REC703-48205-16	899
6L2-44352-00	REC6L2-44352-00	921-850-931	6R3-W0001-A3	REC6R3-W0001-03	1016	703-48205-12	REC703-48205-16	899
6L2-44367-00	REC6L2-44367-00	1051-1055-1055-850-929-930-931	6R5-11361-11-93	REC6R5-11631-11K	1011	703-48205-13	PAT85-08010000W	899
6L2-45113-A1	REC6L2-45113-A2	1017-1018	6R5-11603-00	REC6R5-11603-00	1028-1031	703-48205-13	REC703-48205-16	899
6L2-45215-00	PAF25-04000023	1053	6R5-11603-00	REC6R5-11603-00	1028-1031	703-48205-13	PAT85-08010000W	899
6L2-45567-12	PAF25-04000004-3	1053	6R5-11631-11-93	REC6R5-11631-01K	1029-1031	703-48205-14	REC703-48205-16	899
6L2-45567-14	PAF25-04000004-5	1053	6R5-11631-11-93	REC6R5-11631-01K	1029-1031	703-48205-14	REC703-48205-16	899
6L2-45577-00-10	PAF25-04070005-1	1053-1105	6R5-11631-11-93	REC6R5-11631-11K	1028-1031	703-48205-15	PAT85-08010000W	899
6L2-45577-00-12	PAF25-04070005-3	1105-1132-1133	6R5-11633-10	REC6R5-11633-00	1011-1013-1028-1030-1024	703-48205-15	REC703-48205-16	899
6L2-45611-00	REC6L2-45611-00	1053-1105-1107-1144	6R5-11634-00	REC6R5-11634-00	1028-1031	703-48205-15	PAT85-08010000W	899
6L2-45987-01	REC6L2-45987-00	903	6R5-11634-00	REC6R5-11634-00	1011-1013-1028-1030	703-48205-16	REC703-48205-16	899
6L2-48501-11-00	REC6L2-48501-11-00	927-931	6R5-11634-10	REC6R5-11634-00	1011-1013-1028-1030	703-48205-16	REC703-48205-16	899
6L2-W0078-00	REC6L2-W0078-00	872	6R5-11642-11-93	REC6R5-11642-01K	1011-1029-1031	703-48205-17	PAT85-08010000W	899
6L2-W0093-00	REC6L2-W0093-00	872	6R5-11642-11-93	REC6R5-11642-11K	1028-1031	703-48205-17	REC703-48205-16	899
6L5-14301-03	REC6L5-14301-03	870-877	6R5-11695-00	REC6R5-11695-10	1011	703-48205-17	PAT85-08010000W	899
6L5-24251-00	PAF4-04120005	848-859-861	6R7-11181-A1	REC6R7-11181-A0	1014-1018	703-48205-18	REC703-48205-16	899
6L5-45251-03	REC6L5-45251-03AL	1041-1043-1045-1093-1095	6S1-85885-00	REC6S1-85885-00	878-868-869	703-48205-18	PAT85-08010000W	899
6L5-44322-00	PAF2.6-03000015	929-1041	6T4-45836-00	REC6T4-45836-00AL	934	703-48205-18	REC703-48205-16	899
6L5-44323-00	REC6L5-44323-00	923	6T5-45251-00	REC6T5-45251-00	934	703-48205-18	REC703-48205-16	899
6L5-44352-00	PAF2.6-03000100	1041	6T5-45251-00	REC6T5-45251-00AL	934	703-48205-20	PAT85-08010000W	899
6L5-44352-00	REC6L5-44352-00	921-929	6T5-45371-00	REC6T5-45371-00	934	703-48205-20	REC703-48205-16	899
6L5-45316-09	PAF2.6-03000003	1041	6T5-45371-00	REC6T5-45371-00AL	934	703-48205-21	PAT85-08010000W	899
6L5-45317-09	PAF2.6-03000002	1041	6T5-45371-00	REC6T5-45371-00AL	934	703-48205-21	REC703-48205-16	899
6L5-45551-00	PAF2.6-03000018	1041	6T5-45373-00	REC6T5-45373-00	934	703-48205-21	REC703-48205-16	899
6L5-45560-00	PAF2.6-03000019	1041	6T5-45373-00	REC6T5-45373-00AL	934	703-48206-21	REC703-48206-22	901
6L5-45616-00	PAF4-03080000	1041-1043	6T5-45373-00	REC6T5-45373-00AL	934	703-48206-22	REC703-48206-22	901
6L5-45616-02	REC647-45616-02	1095	6U0-45251-01	REC6U0-45251-01	933	703-48206-22	REC703-48206-22	901
6L5-45631-00	PAF2.6-030000201	1041	6U0-45251-01	REC6U0-45251-01AL	933	703-48207-17	REC703-48207-24	901
6L5-45631-00	PAF2.6-030000202	1041	6U3-45251-01	REC6U3-45251-01	934	703-48207-24	REC703-48207-24	901
6L5-45646-00	PAF4-03080000	1045	6U3-45251-01	REC6U3-45251-01AL	934	703-48230-10	PAF15-13000000W	899
6L5-45943-00-EL	PAF2.6-03010000	1041-1144	6U4-45251-01	REC6U4-45251-01	934	703-48230-10	REC703-48230-14	899
6L5-45987-01	PAF4-03000025	1095	6U4-45251-01	REC6U4-45251-01AL	934	703-48230-11	PAF15-13000000W	899
6L8-G3118-01	REC6L8-G3118-01	912	6U4-45251-01	REC6U4-45251-01AL	934	703-48230-11	REC703-48230-14	899
6M6-14385-00	REC6GH4-14985-01	876	6U4-45373-01	REC6U4-45373-01	933	703-48230-12	PAF15-13000000W	899
6N0-E1603-00	REC6G1-11610-00	989	6U4-45373-01	REC6U4-45373-01AL	933	703-48230-12	REC703-48230-14	899
6N0-G2177-00	REC6N0-G2177-00	911	6X0-82563-01-00	REC6X0-82563-02	906	703-48230-12	REC703-48230-22	900
6N0-G5551-00	REC6N0-G5551-00	1096-1131	6X0-82563-02	REC6X0-82563-02	906	703-48230-13	PAF15-13000000W	899
6N0-G5551-A0	REC68T-45551-00	1047	6X3-48206-01	REC6X3-48206-11	901	703-48230-13	REC703-48230-14	899
6N0-G5560-00	REC6N0-G5560-00	1096-1131	6X3-48206-02	REC6X3-48206-11	901	703-48230-14	PAF15-13000000W	899
6N0-G5571-00	REC6N0-G5571-00	1096-1131	6X3-48206-03	REC6X3-48206-11	901	703-48230-14	REC703-48230-14	899
6N0-W0001-20	REC6G1-W0001-C1	1096	6X3-48206-10	REC6X3-48206-11	901	703-48230-14-P	REC703-48230-14-P	901
6N0-W0078-A0	REC6G1-W0078-A1	926	6X3-48206-11	REC6X3-48206-11	901	703-48230-15	PAF15-13000000W	899
6N0-WG525-00	REC6N0-WG525-00	934	6X3-48206-21-00	REC6X3-48206-22	900	703-48230-15	REC703-48230-14	899
6N0-WG525-00	REC6N0-WG525-00AL	934	6X3-8258A-10-00	REC688-8258A-60	907	703-48230-16	PAF15-13000000W	899
			6X6-82570-50-00	REC6X6-82570-50-00	905	703-48230-16	REC703-48230-14	899
			6X6-82570-A0-00	REC6X6-82570-A0-00	905	703-48230-17	PAF15-13000000W	899
			6X6-8258A-10	REC6X6-8258A-11	907	703-48230-17	REC703-48230-14	899
			6X6-8258A-11	REC6X6-8258A-11	907	703-48230-18	PAF15-13000000W	899
			6X6-8258A-21	REC6X6-8258A-21	907	703-48230-18	REC703-48230-14	899
			6X6-8258A-31	REC6X6-8258A-31	907	703-48230-18	REC703-48230-14	899
			6X6-8258A-30	REC6X6-8258A-31	907	703-48230-1A	PAF15-13000000W	899
			6X6-8258A-41	REC6X6-8258A-41	907	703-48230-1A	REC703-48230-14	899
						703-48230-20	PAF15-13000000W	899
						703-48230-20	REC703-48230-14	899

OEM	REF	
703-48230-21	PAF15-1300000W	899
703-48230-21	REC703-48230-14	899
703-48230-22	REC703-48230-22	900
703-48245-00	PAF15-13010010W	909
703-48261-01	PAF15-13000500W	902
703-48261-11	PAT20-13000500W	902
703-48272-12	REC703-48272-12	900
703-48272-12-00	REC703-48272-12-00	900
703-48293-10	PAF15-11000002W	908
703-48345-01	PAF25-07000007W	902
703-82510-12	PAF15-13000200W	888
703-82510-43	REC703-82510-44	888
703-82563-00	PAE4-10040100W	904
703-82563-00, 01	PAE4-10040100W	895
703-82563-01	PAE4-10040100W	904
703-82563-02	PAE4-10040100W	904
703-82563-20	REC703-82563-21	904
703-82563-21	REC703-82563-21	904
703-83383-00	PAF15-13000300W	905
703-83383-01	PAF15-13000300W	905
703-83383-02	PAF15-13000300W	905
703-83383-10	PAF15-13000300W	905
703-83383-11	PAF15-13000300W	905
704-48205-11	REC704-48205-R0	902
704-48205-12	REC704-48205-R0	902
704-48205-13	REC704-48205-R0	902
704-48205-14	REC704-48205-R0	902
704-48205-15	REC704-48205-R0	902
704-48205-B0	REC704-48205-R0	902
704-48205-B1	REC704-48205-R0	902
704-48205-P0	REC704-48205-R0	902
704-48205-P1	REC704-48205-R0	902
704-48205-R0	REC704-48205-R0	902
704-48207-20	REC704-48207-R0	902
704-48207-21	REC704-48207-R0	902
704-48207-22	REC704-48207-R0	902
704-48207-30	REC704-48207-R0	902
704-48207-31	REC704-48207-R0	902
704-48207-39	REC704-48207-R0	902
704-48207-P1	REC704-48207-R0	902
704-48207-R0	REC704-48207-R0	902
704-82563-31-00	REC704-82563-31-00	906
704-82563-40	REC704-82563-42	905
704-82563-41	REC704-82563-42	905
704-82563-42	REC704-82563-42	905
704-82563-52/00	REC704-82563-52	906
704-82563-H2-00	REC704-82563-H2-00	906
704-82563-J0	REC704-82563-J2	905
704-82563-J1	REC704-82563-J2	905
704-82563-J2	REC704-82563-J2	905
704-82570-08	REC704-82570-12	905
704-82570-10	REC704-82570-12	905
704-82570-11	REC704-82570-12	905
704-82570-12	REC704-82570-12	905
7FK-12158-00	PA166F-010011	941-943-947
7FK-12165-00	PA166F-010010	941-943-947
7NJ-12117-00	PAF8-05030006	941-943
7NJ-12118-00	PAF8-05030007	941-943-947
90101-06M56	REC90101-06M56	1103
90101-08001	PAGB/T5783-M8X35	1001
90105-06035	PAGB/T5783-M6X35	957
90105-06039	PAGB/T5783-M6X16	941
90105-06M01	REC90105-06M01	1113
90105-06M14	PAGB/T5783-M6X16	943
90105-06M25	PAGB/T5782-M6X45	943
90105-08046-00	PAF4-04000033	943
90105-081A7	PAGB/T5783-M8X25	957
90105-08M36	PAF4-04000034	941-947-948
90105-08M36-00	PAF4-04000034	943
90105-08M76	PAF4-04000001	939
90105-08M78	PAF15-07000028	948-953
90105-090006	PAF20-05000002	955
90105-10M00	PAT85-00000012	1079-1081-1085-1087-1089-1125-1127
90105-10M12	PAF25-00000011	1053

OEM	REF	
90105-16M67	PAT85-00000012	1073-1075
90109-06M65	PAF25-05050006	959-963-965-969-971-973-975
90109-08022	REC90109-08022	1005-1009-1013
90109-08262	REC90109-08262	913
90109-08M71	REC90109-08M71	1011
90119-06M04	PAGB/T5783-M6X30	993
90119-06M10	REC90119-06M10	1079-1083-1085-1125-1129
90119-06M48	PAGB/T5783-M5X12	1053
90119-06M80-00	PAGB/T5783-M6X14	945
90119-06M82	PAGB/T5783-M6X20	947-993
90119-06MA3	PAF8-05000022	955
90119-06MA3	PAGB/T5783-M6X20	959
90119-06MA3	PAGB/T5783-M6X25	955-959-1001
90119-06MA4	PAGB/T5783-M6X30	1001
90119-06MA5	PAGB/T5782-M6X35	959-971-973-999-1007
90119-06MA5	PAGB/T5783-M6X25	959
90119-06MA5	PAGB/T5783-M6X30	963
90119-06MA5	PAGB/T5783-M6X35	1009
90119-06MAS	PAGB/T5783-M6X35	959
90119-08191	REC90119-08191	925
90119-08194	REC90119-08194	925
90119-08M01	PAGB/T5782-M8X80	959
90119-08M13	REC90119-08M13	1077-1107-1121-1073-1079-1083-1085-1087-1089-1091-1125-1127-1129-1130
90119-08M14	REC90119-08M14	1059-1063-1067-1071-1111
90119-08M15	REC90119-08M15	997
90119-08M21	REC90119-08M21	1073
90119-08M33	REC90119-08M33	1077
90119-08M87	REC90119-08M87	1077
90119-08MA5	PAGB/T5783-M6X25	1001
90119-09M00	PAF25-05000002	959-965-975
90142-05M06	PAGB/T820-M5X30	1057
90149-06M00	REC90149-06M00	1115
90151-05M05	PAGB/T820-M5X30	1053
90152-05000	REC90151-05M00	1073-1075
90152-05010	PAGB/T820-M5X30	1061-1069
90152-05011	PAGB/T820-M5X20	1051
90152-05M03	PAGB/T820-M5X25	1047
90152-05M04	PAGB/T820-M5X25	1101
90152-05M06	PAGB/T820-M5X30	1065
90170-012138	REC90170-12138	1115
90170-12138	REC90170-12138	1057-1061-1065-1069-1109-1111-1119
90170-16M01	REC90170-16M01	1073-1075-1079-1081-1121-1125-1127
90170-16M01-00	REC90170-16M01	1123
90170-28M37	PAF15-07030005	953
90170-30003	PAF20-05000029	957
90171-10M01	PAF15-06000016	1099
90171-10M01	REC90171-10M01	1047-1049-1051-1101-1144
90171-14013	REC90171-14013-00	1053-1103-1105-1107-1144
90171-16011	REC90171-16011	1057-1061-1065-1069-1073-1075-1109-1111-1115-1119-1121
90171-16011-00	REC90171-16011	1123
90171-18M04	REC90171-18M04	1079-1081-1085-1087-1089-1091-1125-1127-1129-1144
90179-08M06	REC90179-08M06	1049-1051-1099-1101
90179-09M02	REC90179-09M02	1103
90179-10M14	REC90179-10M14	1053-1105-1107-1047-1051-1073-1075-1079-1081-1087-1089-1091-1101
90185-05002	PAGB/T6182-M5	1053
90185-05002	PAGB/T889.1-2000	1053
90185-22043	PAF15-01010007	910
90185-22M11	PAF15-01010007	910
9020-14377	REC90201-14377	993-1023
90201-06M94	PAGB/T5287-6	948-953

OEM	REF	
90201-08784	PAF20-05030013	957
90201-08818	PAF4-04000006	945
90201-08818	PAGB/T5783-M5X12	951
90201-08818-00	PAF4-04000006	939
90201-08M54	PAF4-03000026	1041-1043-1045-1095-1043-1045-1095-1144
90201-10144	PAF25-05050018	969
90201-10M01	PAGB/T96-10	1051-1099
90201-10M01	REC90201-10M01	1047-1144
90201-10M06	PAF25-05050018	961-967-975
90201-11M49	PAF4-03000006	1045-1093
90201-12565	REC90201-12565	991-1023
90201-13198	PAF2.6-03000021	1041
90201-13201	PAF15-07040017	948-953
90201-15017	PAF15-06000020-1	1051
90201-15423	PAF20-05030011	957
90201-17682	REC90201-17682	1049-1051-1099-1101
90201-17M00-00	REC90201-17M00	1123
90201-20417	PAF25-04060007	1053
90201-20417	REC90201-20417	999-1001-1005-1007-1009-1103-1105-1107-1023-1024
90201-22008	PAT40-04050007	1069
90201-22429	REC90201-22429	1057-1061-1065-1109-1111-1115-1119-1079-1083-1085-1125-1127-1129
90201-23008	PAF2.6-04000003	941
90201-23M01	REC90201-23M01	1011-1013-1024
90201-266P2	PAF4-04000004	943
90201-27M00	PAT40-04000008	1059-1063-1067-1071
90201-30M92	REC90201-30M92	1079-1081-1125-1127
90201-46M29	REC90201-46M29	993
90202-12060	PAF25-02000019	1055-1059-1063-1067-1117-1121
90204-11M49	PAF4-03000006	1043-1095-1079-1083-1085-1125-1127-1129
90206-22M19	REC90206-22M19	1115
902082-04010	REC90282-04010	988-989-991-1023
90209-18112	REC90209-18112	993-1023
90209-20M23	REC90209-20159	1025
90209-22248-00	REC90209-22248-00	995-1023-1024
90209-24M03	REC90209-24M03	999-1001-1023-1024
90209-27M07	REC90209-27M07	1024
90214-48M03	REC90214-48M03	1115-1119
90250-03M10	REC90250-03M10	1093
90250-05010	REC90250-05010	1049-1051-1053-1099-1101-1103-1105-1107
90250-05036	REC90250-05036	1097
90250-05046	REC90250-05046	1095
90250-06023	REC90250-06023	1057-1061-1065-1069-1109-1111-1113-1115-1119
90250-07M02	REC90250-07M02	1073-1075-1121
90250-07M02-00	REC90250-07M02	1123
90250-08M07	REC90250-08M07	1079-1081-1087-1125-1127
90280-03017	PAGB/T1099-3X5X13	969
90280-03024	REC90280-03024	929-930-931-932-1067-1071-1096-1097-1099-1107-1109
90280-03M01	PAGB/T1099-3X5X13	948-953-957-963-971-973
90280-03M03	REC90280-03M03	930-931-1059-1063-1073-1105-1111-1119
90280-04002	REC90280-04002	931-1087-1113-1117
90280-04M04	REC90280-04M04	930-931-932-1077-1121
90280-04M04-00	REC90280-04M04	1123
90280-04M05	REC90280-04M05	930-932-933-1079-1083-1085-1089-1125-1127-1129-1130

OEM	REF		OEM	REF		OEM	REF	
90280-04M06	PAF25-05000024	967			963-965-969-975-977-979-981-1001-1003-1005-1007	92990-06300	PAGB/T861.1-6	1051-1041-1045-1047-1053-1093-1097
90280-04M06	PAF4-04000019	961-975	90430-14115	PAF15-04000003		92990-08600	PAGB/T97.1-8	1117
90280-05049	REC90280-05049	995			959-849-850-851-852-853-854-855-856-857	92990-14200	PAGB/T97.1-14	1105-1107-1144
90282-04010	REC90282-04010	1073-1075-1079-1103-1107-1109-1119-1121-1123-1125	90430-14M09	PAF15-04000003		92990-14200	PAGB/T97.1-8	1053
90282-04M00	REC90282-04M00	1081	90445-07MA3	PAF2.6-04000015	1003	92995-05600	PAGB/T97.1-5	959-965-975
		1081-1085-1087-1089-1091-1041-1043-1045-1047-1049-1050-1057-1061-1065-1069-1073-1075-1079-1095-1101-1103-1105-1107-1111-1113-1119-1121-1123-1127-1129	90445-09061	PAF15-05000012	951	92995-05600	PAGB/T97.1-8	951-971-973
90304-08002	REC90340-08002		90445-09068	PAF25-03000008	959-965-975	92995-06600	PAGB/T5783-M5X12	953-1003
			90445-09095	PAF25-03000009	959-965-975	92995-06600	PAGB/T5783-M6X16	1121
			90445-09104	PAF15-05000014	951-965-975	92995-06600	PAGB/T96-6	963
			90445-09104	PAF25-03000009	963	92995-06600	PAGB/T96-6	939-941-943-947-948-963-965-969-971-973-977-979-981-988-989-991-1001-1005-1045-1047-1049-1073-1077-1089-1101-1105-953-993-995-999-1007-947-977-982-1079-1083-1085-1087-1089-1091-1093-1113-1119-1125
90340-08014	REC90340-08002	1099-1109	90445-09105	PAF25-03000011	959	92995-08600	PAGB/T97.1-8	1057
90340-08M04	REC90340-08002	1053-1093-1097-1125	90445-09251	PAF25-03000011	963	92995-10600	PAGB/T97.1-8	1053-1057-1061-1065-1069-1073-1075-1085
90340-08M14	REC90340-08002	1115	90445-09807	PAF4-04000012	943	9306-306V5	REC93306-306V5	999-1021
90340-14M00	PAF15-04000002	1003-1007	90445-09808	PAF2.6-04000007	941	93101-10M14	PAF4-04060004	1043-1045
		959-963-965-969-971-973-975-977-979-981	90445-10M40	PAF40-05000053	977	93101-10M14	REC93101-10M14	1095
90340-14M06	PAF15-04000002	971-973	90445-10M46	PAF15-07010007	951	93101-10M25	REC93101-10M25	988
			90465-06M86	PAT36-04000023	947	93101-11M23	REC93101-11M23	1047-1096
90344-51003	PAF15-07010004	971-973	90465-08M99	PAGB/T5783-M5X12	939	93101-13018	REC93101-13018	993
90381-14020	REC626-45316-09	1101	90465-11M10	PAHT-2.5X60	948-959-965-975-977-981-1059-1063-1067-1071-1073-1077-1079	93101-13M12	PAF4-03050002	1041-1043
90381-20001	REC90381-20001	911	90465-11M10	PAHT2.5X50	955	93101-13M12	REC93101-13M12	1045-1095
90386-10M16	PAT85-01010203	911	90465-11M59	REC90401-11425	981	93101-14M01	REC93101-14M01	991
90386-18M35	PAT85-00000017	911			988-991-993-997-1003-1005-1007	93101-15074	REC93101-15074	1047-1096-1097
90386-18M63	REC90386-18M63	911	90467-06016	PAHT-2.5X60	997-1003-1005-1007	93101-16001	REC93101-16001	995-999
90386-22M13	REC90386-22M13	911	90467-08004	PAF4-04000030	1009	93101-17054	REC93101-17054	1049-1051-1099-1101
90386-22M15	PAF15-01010302	911	90467-08M01	PAF4-03000005	1043-1045-1095	93101-18050	REC93101-18050	1097
90386-22M98	REC90386-22M98	911	90467-09M09	PAF4-04000030	959-991	93101-20001	REC93101-20048	1050
90386-25M31	REC90386-25M31	911	90480-06M19	PAF20-05000036	957	93101-20048	REC93101-20048	1049-1099-1101-1113
90386-30048	PAF15-01000004	911	90480-10M16	PAF15-07050003	953	93101-20M07	REC93101-20M07	1053-1103-1105-1107
90386-30M60	PAF15-01000006	911	90480-10M16	PAF15-07050003	953	93101-20M29	REC93101-20M29	988-991
90386-30M77	PAT85-01020005	911	90480-12072	PAF15-07010027	953-977-979	93101-20M34	REC93101-20M34	989
90386-30M77	REC90386-30M77	911	90480-18065	REC90480-18065	1001-1005	93101-22067	REC93101-22067	1103-1105-1109-1115-1117-1119
90386-30M78	PAT85-01020003	911	90480-20M05	REC90480-20M05	916-977-979-1009-1011-1013	93101-22067	REC93101-22M00	1055
90386-38M89	REC90386-38M89	911	90501-10064	PAF4-03030003	1041	93101-22M00	REC93101-22M00	1057-1061-1065-1069-1111-1113
90386-44M03	PAF25-01000004	911	90501-120A5	PAF20-05030007	957	93101-22M15	REC93101-22M15	1011-1013
90386-52M02	PAF25-01000001	911	90501-12M48	REC90501-12M48	1073-1075-1123	93101-22M60	REC93101-22M60	1059-1063-1111
90387-06119	REC624-42542-00	875	90501-14M02	REC90501-14M02	1001	93101-23070	REC93101-23070	1073-1107-1109-1119
90387-06806	PAF4-00000001	1043-1045	90501-14M06	PAF15-06070002	1049-1099-1101	93101-25018	REC93101-25018	993
90387-06M14	PAF4-00000001	1095	90501-150A0	PAF15-06070002	1051	93101-25M03	REC93101-25M03	1073-1075-1077-1121
90387-06M69	PAF25-03000007	911	90501-15M01	PAT40-04050002	1111	93101-25M03-00	REC93101-25M03	1123
90387-13001	PAF15-07040009	953	90501-16233	REC90501-16233	1119-1121	93101-25M28	REC93101-25M35	997
90387-13002	PAF15-07040011	953	90501-16M01	REC90501-16M01	1109-1115	93101-25M57	REC93101-25M57	1067-1071
90387-13006	PAF20-05030006	957	90501-16M11	REC90501-16M11	916-977-979-1009-1011-1013	93101-28M16	REC93101-28M16	1079-1083-1085-1087-1089-1125-1127-1129-1130
90387-13M56	PAF15-07040012	948-953	90501-16M37	REC90501-16M37	1079-1081-1125-1127	93101-300002	REC93101-30002	1087-1089
90387-32002	REC90387-32002	995	90501-18001	PAF60-04020002	1061-1065-1069	93101-30M17	REC93101-30M17	1079-1081-1085-1125-1127-1129
90389-22M01	REC90389-22M01	1057-1061-1065-1069-1111-1115-1144	90606-12019	REC93606-12019	973	93101-30M33	REC93101-30M33	1001
90389-25M00	REC90389-25M00	1073-1075-1121-1144	91490-25030	PAGB/T91-1.6X12	1041-1043-1045-1095	931013M3700	REC93101-13M37	985
90430-06M03	REC90430-06M03	977-979-981-982-1097-1113-1115	91490-30020	PAGB/T91-2.5X20	1099	93102-10004	PAF4-04060004	945-947
			91490-30020	REC91490-30025	1047-1049-1101	93102-15M32	REC93102-15M32	987
90430-08003	REC90430-08020	1050-1061-1065-1069-1073-1075-1079	91490-30022	PAGB/T91-1.6X12	1053-1105-848-849-850-1144	93102-18M21	PAF15-07040008	948-953
			91490-30025	REC91490-30025	1057-1061-1065-1069-1073-1107-1111-1115	93102-20070	PAF2.6-04010001	987
			91490-30030	REC91490-30030	1103-1109-1144	93102-20108	PAF2.6-04010001	939-945-947
90430-08020	REC90430-08020	1041-1043-1045-1047-1049-1057-1081-1085-1087-1089-1091-1093-1095-1096-1097-1099-1101-1103-1105-1107-1109-1111-1113-1115-1119-1121-1125-1127-1129	91490-30040	REC91490-30040	1075-1119-1121	93102-20108	PAGB/T97.1-8	951
			91490-40025	REC91490-30025	1079-1081-1085-1087-1089-1091-1125-1127-1129			
90430-08020-00	REC90430-08020	1123	91490-40030	REC91490-30025	1123-1144			
90430-08143	PAF4-04000006	965-977-979	91490-40030-00	REC91490-30025	1001			
90430-08800	PAF4-04000006	947	91690-30010	PAGB/T879.4-3X20	949			
90430-08800-00	PAF4-04000006	943	91810-03014	PAF15-07000001	949			
		1055-1059-1063-1067-1111-1117-1121	92885-06600	PAGB/T96-6	945-955-965-975-953-997-1059-1093-1097-1099-1117			
90430-12072	REC90430-12072		92903-06600	PAGB/T848-6	971-973			
90430-12072-00	REC90430-12072	1123	92955-08600-00	PAGB/T97.1-8	945			

OEM	REF		OEM	REF		OEM	REF	
93102-20M25	REC93102-20M25	989-991	93210-42101	REC93210-42101	1093	93306-208U0	REC93306-208U0	1011-1013-1079-1125-1022-1023-1141
93102-22010	PAF20-05030005	957	93210-42159	REC93210-42159	989-991-997-1005	93306-209U0	REC93306-209U0	1081-1087-1127-1141-1142-1143
93102-23096	REC93102-23096	1003	93210-42M70	REC93210-42M70	991	93306-272Y2	PAGB/T276-62/22/P6	939
93102-25008	REC93102-25008	995	93210-44398	PAJASOF404-31-045	1101	93306-303V1	REC93306-306V1	1001-1007-1021-1022
93102-25014	PAF15-07030006	957	93210-44398	REC93210-44398	1047-1049-929-931	93306-305-U8	REC93306-305U8	1003-1021
93102-25090	PAF4-04010004	945	93210-45161	PAF25-04050003	850-929-930-931-1055-1105	93306-305U3	REC93306-305U3	995-997-1021
93102-25090	PAGB/T5783-M5X12	951	93210-46044	REC93210-46044	1073-1077-1121	93306-307U0	REC93306-307U0	999-1001-1021-1022
93102-25M28	REC93102-25M28	1003	93210-46044-00	REC93210-46044	1123	93310-112V0	REC93310-112V0	988-989-1026-1020-1021
93102-25M48	REC93102-25M48	993	93210-46M16	REC93210-46M16	993-995-1007-1009	93310-32337	REC93310-32337	1013-1028-1030
93102-25M52	PAF15-07030007	951	93210-48001	PAJASOF40424-050	1071	93310-323V6	REC93310-32337	1011
93102-26M27	REC93102-26M27	997	93210-48214	PAJUSB2401P48	1041-1043	93310-418U0	REC93310-418U0	991-1021
93102-28135	REC93102-28135	1005	93210-48214	REC93210-48214	1045-1091-1095	93310-418U1	REC93310-418U1	1025
93102-30M05	REC93102-30M05	1009	93210-48M68	REC93210-48M68	1059-1067-1111	93310-418V1	REC93310-418V1	988-989-1026-1020-1021
93102-30M23	REC93102-30M23	1007	93210-49046	REC93210-49046	1047-1051-1073-1077-1096-1109-1119-1121-929	93310-620V5	REC93310-620V5	993-1021
93102-30M56	REC93102-30M56	999	93210-49046-00	REC93210-49046	1123	93310-62406	REC93310-624U5	995-1021
93102-32M07	REC93102-32M07	995-1005	93210-53M08	REC93210-53M08	1047-1096	93310-636U4	REC93310-636U4	1009-1022
93102-35M13	REC93102-35M13	1011-1013	93210-54M54	REC93210-54M54	989	93310-727U0	REC93310-727U0	999-1021
93102-35M18	REC93102-35M18	1001	93210-56M80	PAF15-06080003	997-1049-1051-1101	93310-727V7	REC93310-727V7	1001-1021
93102-35M47	PAF25-05020002	961-967	93210-57M00	REC93210-57M00	1113	93310-730V8	REC93310-730V8	1005-1009-1022
93102-35M51	PAF15-07030006	951	93210-57M09	REC93210-57M09	1049-1051-1099-1101	93310-835U8	REC93310-835U8	1009-1022
93102-36M02	REC93102-36M02	1009	93210-58144	REC93210-58677	1079-1083-1125-1127	93310-836V2	REC93310-836V2	1011-1013-1022-1023
93102-36M24	REC93102-36M24	1007	93210-58M21	REC93210-58677	1097	93310-954U1	REC93310-954U1	1011-1013-1022-1023
93102-37004	PAF25-05050021	957	93210-59M67	REC93210-59M09	995-1003	93311-632U1	REC93311-632U1	1005-1021
93102-37M40	PAF25-05050021	961-963-967-969-971-973-975	93210-60MA3	REC93210-59MG7	1059-1063-1067-1071-1111-930-931	93311-632U7	REC93311-632U7	997-1021
93102-38008	REC93102-38008	979	93210-62M29	REC93210-60MA3	1107	93311-636U6	REC93311-636U6	1007-1021-1022
93102-38M59	REC93102-38008	977-979	93210-64488	REC93210-62269	1005-1009	93311-83280	REC93311-83280	1085-1087-1089-1129-1142-1143
93102-40M14	REC93102-40M38	1011-1013	93210-64ME7	REC93210-65752-00	1085-1087	93311-85894	REC93311-85894	1087
93102-43M42	PAF25-05020003	961-963-967-969-971-975	93210-65M50	REC93210-64ME7	1053-1105	93311-928U5	REC93311-928U5	1083-1127-1141-1142-1143
93103-09M41	PAF2.6-03000004	1041	93210-66M98	REC93210-65M50	999-1001-1007-1053-1105	93311-940U3	REC93311-940U3	1011-1013-1022-1023
93103-10052	REC93103-10052	1093	93210-69M98	REC93210-66M98	1109-1115-1119	93314-314V8	REC93341-214U1	1049
93103-11051	REC93103-11051	1093	93210-74M35	REC93210-69MG6	1057-1061-1065-1069-1091-1111	93315-017U4	REC93315-017U4	1103-1138-1139
93104-16M01	REC93104-16M01	1001-1003	93210-74M55	REC93210-74M35	1011-1013	93315-217U0	REC93315-217U0	1113-1139
93104-16M04	REC93104-16M01	997	93210-74MG5	REC93210-74MG5	1057-1061-1065-1069-1111	93315-22004	REC93315-22004	1053-1103-1105-1107-1138-1139
93104-18049	REC93104-18049	1005	93210-85M97	REC93210-74MG5	1121	93315-220V7	PAGB/T290F-2020	1055
93104-20M02	REC93104-20M02	1009	93210-85M97-00	REC93210-85M97	1123	93315-220V7	REC93315-220V7	1105-1107-1138-1139
93104-22M07	REC93104-22M07	1087	93210-86M38	REC93210-85M97	1089-1125-1127-1129-1130	93315-314V8	REC93315-314V8	1049-1050-1101-1137-1138
93106-09014	REC93106-09014	1063-1067-1071-1073-1077-1079-1083-1085-1087-1089-1119-1121-1125-1127-1129	93210-86M38	REC93210-86M38	1073-1075-1079-1125	93315-317U2	REC93315-317U2	1049-1051-1099-1101-1137-1138
93106-09014-00	REC93106-09014	1123	93210-86M39	REC93210-86M39	1087-1091	93315-32224	REC93315-32224	1067-1071-1109-1111-1117-1119-1138-1139-1140
93106-18M01	REC93106-18M01	1007	93210-94003	REC93210-86M39	1140	93315-324U1	REC93315-324U1	1113-1139
93109-44M00	REC93109-44M00	910	93210-94003	REC93210-94003	930-932-933-1079-1083-1085-1089-1125-1127-1129-1130	93315-325V1	REC93315-325V1	1139-1140-1141
93110-23M00	REC93110-23M00	993	93210-97M55	REC93210-94003	1073-1075-1079-1125	93315-325V1-00	REC93315-325V1	1123
93210-05001	PAF2.6-03000009	1041	93211-04001	REC93210-97M55	1081-1127	93315-425U7	REC93315-425U7	1079-1125-1141
93210-06ME6	REC90430-08020	1053	93306-001U1	REC93211-04001	1011-1013	93315-425V3	REC93315-425V3	1081-1127-1141-1142-1143
93210-06ME6	REC93210-06ME6	1047-1049-1051-1055-1059-1101-1111	93306-004U0	PAGB/T276-6004C2	1047	93315-43061	REC93315-43061	1127-1129-1141-1142-1143
93210-07003	REC93210-07540	1083	93306-004YH	PAGB/T276-6004C2	1047	93315-43064	REC93315-43064	1089
93210-09004	PAF2.6-04060002	939	93306-00501	REC93306-00501	1049-1051-1099-1101-1137-1138	93315-430U8	REC93315-43061	1079-1125-1141
93210-12MG9	PAF25-05050013	961-967-975-848-849-852-853-854-855-948-955-963-969-971-973	93306-00519	REC93306-00519	1097-1137	93315-628U9	REC93315-628U9	1079-1125-1141-1142
93210-13M63	PAGB/T3452.1-13X2	853-854-855-948-955-963-969-971-973	93306-00612	PAGB/T276-6006/P6	1053	93316-003Y0	PANTN16003EY	1041
93210-14515	PAF25-05050014	961-967-975	93306-00612	REC93306-00612	1103-1105-1107-1138-1139	93317-22204	REC93317-22204	1057-1061-1065-1069-1109-1111-1115-1119-1138-1139-1140
93210-22M02	REC93210-22M02	1001	93306-00612	REC93306-00612	1107-1138-1139	93317-322V0	REC93317-322V0	1139-1140
93210-24M79	PAJASOF40431-025	848-849-853-854-939-949-955-959-963-965-975-977-979-981-982	93306-00702	REC93306-00702	1109-1115-1119-1138-1139-1140	93317-325U0	REC93317-325U0	1073-1075-1140-1141
93210-24M79	PAJASOF40435-022	945-948-953-969-971-973	93306-20401	REC93306-204Y7	1113	93317-325U0-00	REC93317-325U0	1123
93210-33M49	PAJASOF404-19-033	1087-1089	93306-204U0	REC93306-204Y7	988-989-991-1020-1021	93317-330U2	REC93317-330U2	1079-1083-1085-1089-1125-1127-1129-1141-1142-1143
93210-33M85	PAJASOF404-19-033	1041	93306-205B2	PANTN6205C3	947			1143-1141
93210-33MG4	REC93210-33MG4	1059-1063-1067-1071-1111	93306-205U7	REC93306-205U7	993-1021			
93210-33MH2	PAF25-05050015	961-967-975	93306-205YD	PAGB/T276-6004C2	945			
93210-35537	PAF4-04060002	939-945	93306-205YD	PAGB/T5783-M5X12	951			
93210-35537	PAGB/T345.2-D32.5XD1	947	93306-206U5	REC93306-206U5	1009-1022			
93210-37160	REC93210-37M67	1079-1083-1085-1087-1089-1091-1125-1127	93306-207U0	REC93306-207U0	1073-1075-1121-1139-1140-1141			
93210-37M67	REC93210-37M67	1129-1130	93306-207U0-00	REC93306-207U0	1123			
93210-41042	REC93210-41042	1107-1109-1117-1119						

OEM	REF	
93332-00001	REC93332-00001	1059-1063-1067-1071-1107-1111-1119-1138-1139-1140
93332-00003	REC93332-00003	1057-1061-1065-1111-1115-1119-1139-1140
93332-00005	REC93332-00005	1049-1051-1053-1099-1101-1103-1105-1137-1138-1139
93332-00048	REC93332-00048	1081-1085-1141-1142-1143-1117
93332-00079	PAT40-04000027	1117
93332-00092	PAKOYOH-CAP322/32	1069
93332-000A5	REC93332-000A5	1087
93332-000U0	REC93332-000U0	1113-1139
93332-000U2	REC93332-000U7	1081
93332-000U3	REC93332-000U3	1073-1077-1121
93332-000U3-00	REC93332-000U3	1123
93332-000U7	REC93332-000U7	1079-1125-1141
93332-000UE	REC93332-000UE	999-1001-1021-1022
93332-000V3	REC93332-000V3	1081-1127-1141-1142-1143
93332-000W5	PAHL-CAP32004JRKYOY	1055
93332-000W7	REC93332-000W7	1121-1138-1140-1141
93332-000W7-00	REC93332-000W7	1123
93332-000WS	REC93332-000WS	1105-1138-1139
93340-67011	REC93340-67011	1087-1091
93341-214U1	REC93341-214U1	1099
93341-41414	REC93341-41414	1101-1137-1138
93341-93020	REC93341-93020	1085-1129
93341-930U9	REC93341-93020	1089
93341-930V2	REC93341-930V2	1079-1083-1125-1127-1141-1142-1143
93399-99951	REC93399-99951	995-1021
93420-22M03	PAGB/T893.1-22	1045
93430-06005	PAGB/T896-86	1093
93430-08020	REC90430-08020	1130
93430-10M00	PAGB/T896-9	910
93440-08819	PAF2.6-03000012	1041
93440-52008	REC93440-52009	993
93440-68M03	REC93440-68M03	999-1001
93450-13022	REC93450-13022	988-989-991-1026
93450-13130	PAF2.6-04020006	941
93450-14088	PAF4-04020006	943-986
93450-15023	PAF15-07020005	951-986
93450-15023	REC93450-15023	993-1026
93450-17129	PAF20-05020002	957-986
93450-17129	PAF25-05020106	961-963-967-969-971-975-986-997
93503-16003	REC93503-16003	1073-1075-1079-1081-1123-1125-1127
93507-32009	REC93507-32031	1079-1081
93507-32031	REC93507-32031	1125-1127
93511-32017	REC93511-32027	1081
93511-32027	REC93511-32027	1079-1125-1127
93602-14104	REC93602-14104	993-1026-1021
93602-14118	REC93602-14118	991-1026-1021
93602-20M02	REC93602-20M02	995-1003-1026-1027-1021
93603-18M09	REC93603-18M09	1007-1026-1028-1021-1022
93603-21111	REC93310-32337	1029
93603-21111	REC93603-21111	999-1001-1005-1009-1027-1028-1029-1021-1022-1023
93604-07M13	PAF2.6-03000013	1041
93604-09066	PAF4-03000016	848-929-1043-1045-1095
93604-09068	PAF2.6-03000013	1093
93604-10M03	PAF15-00000013	969-1073-1101-939-941-1041-1047-1049-1050-1051-1101
93604-12M07	PAF15-00000013	951
93604-12M07	PAF15-07000013	951
93604-18080	PAF4-03000013	1041-1043-1045-1095
93605-14143	PAF25-05050016	961-967-975
93606-11M24	REC93606-12019	1055

OEM	REF	
93606-12019	REC93606-12019	955-963-969-971-975-977-979-981-982-988-993-995-997-1003-1057-1061-1065-1069-1073-1075-1079-1083-1085-1087-1089-1091-1099-1117-1121-1125-1127-1129-1130
93608-12063	PAF15-00000014	999
93608-12063	PAF25-00000014	1001-1005-1007-1009
93608-12M05	REC93608-12M05	1079-1085-1089-1091-1129
93700-06M03	PAJB/T9740.1-M6	910
94190-30020	REC91490-30025	848-849-851-852-853-1051-1144
947395-06040	PAGB/T5782-M6X45	1099
95380-05600	PAGB/T889.1-M5	1057-1061-1065-1069-1115
95380-06700	REC95380-06700	1059-1111
95817-06012	PAGB/T5783-M6X12	939
95817-06012-00	PAGB/T5783-M6X12	945
95895-06012	PAGB/T5783-M6X14	1045
95895-06012	PAGB/T5783-M6X35	1093-1097
95895-06016	PAGB/T5783-M5X12	1045-1047
95895-06016-00	PAGB/T5783-M5X12	1043
95895-06020	PAGB/T5783-M5X12	1041
95895-06035	PAGB/T5782-M6X125	1053
95895-06035	PAGB/T5783-M6X30	1051
970-95-06030	PAGB/T5783-M6X30	997
97013-05010	PAGB/T5783-M5X10	947
97013-06012	PAGB/T5783-M6X12	957
97013-06016	PAGB/T5783-M5X12	953-989-995
97013-06035	PAF15-07000030	965
97013-06035	PAGB/T5782-M6X125	961-1043
97013-06040	PAF20-05010007	955
97013-06045	PAGB/T5783-M5X12	939
97075-08025	PAGB/T5783-M8X25	977
97075-08035	PAGB/T5783-M8X35	1047
97075-10040	REC97075-10040	1057-1061-1065-1069-1075-1119-1121
97080-08025	PAGB/T5783-M8X25	1047-1049-1051-1101
97080-08045	REC97080-08045	1047-1049-1101
97090-06014	PAGB/T5783-M6X16	1093
97095-05012	PAGB/T5783-M5X12	959
97095-05012	PAGB/T818-M5X12	965-971-973-975-979
97095-05016	PAGB/T5783-M5X16	1093
97095-0512	PAGB/T5783-M5X12	951
97095-06010	PAGB/T5783-M6X10	965-1099-1113
97095-06016	PAGB/T5783-M6X16	988-989-991-993-997-1001-1005-1077-1089
97095-06016	PAGB/T96-6	1121
97095-06020	PAGB/T5783-M6X20	939-941-947-948-959-963-965-969-971-973-975-977-981-999-1003-1007-1049-1097-1101
97095-06020-00	PAGB/T5783-M6X20	943
97095-06025	PAGB/T5782-M6X25	977-981-997
97095-06030	PAGB/T5783-M6X30	948-979-981-1093-1096
97095-06030	REC90101-06M56	977
97095-06035	PAGB/T5783-M5X12	953
97095-06040	REC97095-06040	1097-1105
97095-06045	REC97095-06045	979-1045-1096
97095-08014	PAGB/T5783-M8X14	939-947
97095-08014-00	PAGB/T5783-M8X14	943
97095-08020	PAF4-04000001	1085-1087-1089-1091
97095-08020	PAGB/T5783-M8X20	947
97095-08020-00	PAF4-04000001	945
97095-08020-00	PAGB/T5783-M8X20	945
97095-08025	PAGB/T5783-M8X25	1057-1061-1065-1069-1079-1083-1085-1089
97095-08035	PAGB/T5783-M8X35	1061-1065-1069

OEM	REF	
97095-08045	REC97095-08045	1051-1113-1117-1119-1109
97095-08055	REC97095-08055	1113-1117-1119
97395-06020	PAGB/T5783-M6X20	1099
97395-08070-00	REC97395-08070	1123
97513-06525	PAGB/T5783-M6X25	953
97575-06520	PAGB/T5783-M6X20	1051
97575-08530	PAGB/T5783-M8X30	1051
97575-08550-00	PAGB/T5783-M5X12	951
97575-08550-00	PAGB/T5787-1986	945
97595-06520	PAGB/T5783-M6X20	953-955
97595-06520	PAGB/T97.1-8	951-959-961-1041
97607-04210	PAGB/T818-M4X10	955-963-965-969-971-973-975
97780-40112	PAGB/T845-ST4.2X16	1099
97780-50510	PAGB/T845-ST4.8X9	1099
97880-05025	PAGB/T818-M5X25	941-947-971-973
97880-05025-00	PAGB/T818-M5X25	943
97D95-06045	REC97D95-06045	924
97E95-08545	REC97E95-08545	925
97E95-08555	REC97E95-08555	925
98503-04066-00	PAGB/T818-M4X6	945
98580-06016	PAGB/T818-M6X16	1115
98780-04015	PAGB/T820-M4X12	981-1005
98780-04016	PAGB/T820-M4X12	955-977-1003
98980-05025	PAGB/T818-M5X25	955
99001-06600	PAGB/T896-86	1041-1043-1095
99001-06600	REC99001-06600	1045-1096
99001-08600	REC99001-08600-00	1063-1067-1071-1073-1077-1079-1083-1085-1087-1089-1119-1121-1125-1127-1129
99080-10600	PAGB/T896-9	910
99510-10114	PAF15-07000001	948-951-953
99510-10114	PAF4-04000003	943
99530-08012	PAF25-00000014	959-965-969-971-973-975
99999-02808	REC99999-02808	912
99999-03116	PAF15-01010301S	910
99999-03249	REC99999-03249	885
99999-03938	REC99999-03938	885
99999-03946	REC99999-03946	934-857
99999-03946	REC99999-03946AL	934
62Y2441000, 1, 2, 3, 4	PAF25-05130000	864
62Y244100400	PAF25-05130000	864
CS3-43880-00	REC62Y-43880-02	896
F5-85570-13	REC6F5-85570-11	880
JA9-12153-00	PA166F-000001	941-943-947
KOA-A3721-00	RECKOA-A3721-00	977
KOA-A3722-00	RECKOA-A3722-00	977
N26-13440-00	REC26-13440-00	982
N26-13440-00, 02	REC26-13440-00	862
N51-11325-01	REC26-11325-01	935

REF	OEM	
G		
GS31074	6Y1-24305-05-00	858
GS31074	6Y1-24305-06-00	858
GS31074	6YL-24305-01-00	858
GS31075	6G1-24305-00, 01, 02	858
GS31075	6G1-24305-02-00	858
GS31075	6G1-24305-03-00	858
GS31075	6G1-24305-04-00	858
GS31075	6G1-24305-05-00	858
GS31075	6G1-24305-0500	858
GS31075	6Y1-24305-00, -01, -02	858
GS31075	6Y1-24305-05-00	858
GS31075	6Y1-24305-06-00	858
GS31075	6YL-24305-01-00	858
P		
PA166F-000001	JA9-12153-00	941-943-947
PA166F-010001	67D-12111-00	941-948
PA166F-010008	67D-12157-00	941-943-947
PA166F-010009	67D-12151-00	941-943-947
PA166F-010010	7FK-12165-00	941-943-947
PA166F-010011	7FK-12158-00	941-943-947
PA60-04000004	63D-44144-00	1063-1067-1071
PAE4-10040100W	703-82563-00	904
PAE4-10040100W	703-82563-00, 01	895
PAE4-10040100W	703-82563-01	904
PAE4-10040100W	703-82563-02	904
PAF115-05000091	6EK-W4624-00	1031
PAF15-00000001	63V-45551-00-4D	910
PAF15-00000001	66M-44551-00-4D	910
PAF15-00000002	682-44555-30	912
PAF15-00000003	66M-44557-00	913
PAF15-00000005	66M-45113-00	1034
PAF15-00000013	93604-10M03	969-1073-1101 939-941-1041- 1047-1049- 1050-1051-1101
PAF15-00000013	93604-12M07	1047-1049- 951-984
PAF15-00000014	66M-11351-10	999
PAF15-00000014	93608-12063	985
PAF15-00000014		911
PAF15-01000001	65F-42537-00	911
PAF15-01000004	90386-30048	911
PAF15-01000006	90386-30M60	911
PAF15-01010001	63V-43131-00	910
PAF15-01010001	63V-43131-01	910
PAF15-01010001	63V-43131-10	910
PAF15-01010007	63V-43145-00	910
PAF15-01010007	90185-22043	910
PAF15-01010007	90185-22M11	910
PAF15-01010100	63V-43111-00-4D	909
PAF15-01010100	63V-43111-01-4D	909
PAF15-01010100	63V-43111-A2-4D	909
PAF15-01010200	63V-43112-00-4D	909
PAF15-01010200	63V-43112-01-4D	909
PAF15-01010200	63V-W4311-00-4D	909
PAF15-01010200	63V-W4311-03-4D	909
PAF15-01010200	63V-WS431-B6-8D	909
PAF15-01010301S	63V-43311-00-4D	910
PAF15-01010301S	63V-43311-01-4D	910
PAF15-01010301S	99999-03116	910
PAF15-01010302	90386-22M15	911
PAF15-01030100	65W-42138-00	909
PAF15-02000005L	66M-44361-10	1049
PAF15-02000005S	66M-44361-00	1049
PAF15-02000006	63V-44365-10	1047-1049-1101
PAF15-02010000	66M-44514-00-4D	913
PAF15-03000003	66M-45115-00	1032
PAF15-04000002	90340-14M00	1003-1007 959-963-965- 969-971-973- 975-977-979- 981
PAF15-04000002	90340-14M06	963-965-969- 975-977-979- 981-1001-1003- 1005-1007
PAF15-04000003	90430-14115	

REF	OEM	
PAF15-04000003	90430-14M09	959-849-850- 851-852-853- 854-855-856- 857
PAF15-04000005	676-11372-00	941-947-949- 951-963-981- 991-993-995- 997-999
PAF15-04000005	6H1-11372-00	955
PAF15-04010004	66M-41138-00	1032
PAF15-05000009	68L-44391-00	917
PAF15-05000009	6H3-44391-00	917
PAF15-05000009	6H3-44391-01	917
PAF15-05000011	688-24378-00	951-959-963- 965-975
PAF15-05000012	90445-09061	951
PAF15-05000014	90445-09104	951-965-975
PAF15-05170300W	6G1-81941-10	884-888
PAF15-06000001	63V-45311-01-4D	1101
PAF15-06000002	63V-45215-00	1051-1101-1047
PAF15-06000003	6G1-45214-00	1047-1051-1101
PAF15-06000004	61N-45251-00	1053
PAF15-06000006	63V-45536-00	1049-1050-1101
PAF15-06000009	6E7-45587-01-30	1099
PAF15-06000009	6E8-45587-30	1051
PAF15-06000010-1	664-45567-01-10	1049-1101
PAF15-06000010-1	664-45567-05	1099
PAF15-06000010-1	664-45567-01	1051
PAF15-06000010-2	664-45567-10	1051
PAF15-06000010-2	664-45567-12	1099
PAF15-06000010-3	664-45567-20	1051
PAF15-06000010-5	664-45567-30	1099
PAF15-06000010-5	664-45567-40	1051
PAF15-06000010-6	664-45567-50	1051
PAF15-06000010-7	664-4556-50	1099
PAF15-06000010-7	664-45567-60	1051
PAF15-06000014	63V-44328-00	1047-1049-1101
PAF15-06000014	63V-44328-01	1051
PAF15-06000015	6E7-45987-01	1101
PAF15-06000016	90171-10M01	1099
PAF15-06000020-1	90201-15017	1051
PAF15-06020005	63V-45375-00	1047-1049- 1101-1050
PAF15-06030000L	63V-44150-10	1049-1101
PAF15-06030000S	63V-44150-00	1049-1101
PAF15-06040000S	63V-45510-00	1049
PAF15-06070002	90501-14M06	1049-1099-1101
PAF15-06070002	90501-150A0	1051
PAF15-06080000	683-45361-02-8D	1051
PAF15-06080003	93210-56M80	997-1049-1051- 1101
PAF15-06080006-1	626-45577-00	1051-1101
PAF15-06080006-1	626-45577-00-01	1049-1099
PAF15-06080006-2	626-45577-10	1051
PAF15-06080006-3	626-45577-00-03	1099
PAF15-06080006-3	626-45577-20	1051
PAF15-06080006-4	626-45577-30	1051
PAF15-06080006-5	626-45577-00-05	1099
PAF15-06080006-5	626-45577-40	1051
PAF15-06090000	63V-45943-10-00	1144
PAF15-06100000L	66M-45300-11-4D	1038-1049
PAF15-06100000S	66M-45300-02-4D	1038-1049
PAF15-07000001	99510-10114	948-951-953
PAF15-07000001	91810-03014	949
PAF15-07000013	93604-12M07	951
PAF15-07000016	661-41262-01	876
PAF15-07000016	661-41262-02	876
PAF15-07000024	66M-46297-00	953
PAF15-07000028	90105-08M78	948-953
PAF15-07000030	97013-06035	965
PAF15-07000031	66M-12411-00	914
PAF15-07000031	66M-12411-01	914-947-948- 951
PAF15-07000031	6G8-12411-02	959
PAF15-07000031	6G8-12411-03	963-965-969- 971-973-975
PAF15-07000031		850-851-852- 853-915
PAF15-07000100	66M-11181-10	953-983-985
PAF15-07000200	66M-85580-00	883
PAF15-07000300	66M-85520-00	882

REF	OEM	
PAF15-07000400	66M-85533-00	879
PAF15-07000500	66M-85540-10	892
PAF15-07000600	66M-85570-00	880
PAF15-07010000	66M-15100-02-1S	951
PAF15-07010004	90344-51003	971-973
PAF15-07010006	6E5-24377-00	949-951
PAF15-07010007	90445-10M46	951
PAF15-07010008	66M-11325-00	951
PAF15-07010009	66M-11328-00	849-850-851- 852-853-951- 959-965-971- 973-975
PAF15-07010011	66M-11327-00-94	951-959-965- 971-973-975
PAF15-07010012	66M-12535-00	951-959-965- 971-973-975
PAF15-07010014	66M-11357-00	951
PAF15-07010018	66M-41114-01	849-917-951
PAF15-07010021	6H3-12413-00-1S	965-975-1007
PAF15-07010021	6H3-12413-00-9M	959
PAF15-07010021	6H3-12413-001S	951
PAF15-07010023	5GH-13440-00	951
PAF15-07010024	66M-11416-00	951
PAF15-07010026	6E5-11325-00	951
PAF15-07010027	90480-12072	953-977-979
PAF15-07010100	62Y-82504-10	879
PAF15-07010100	65W-82504-00	879
PAF15-07010200	66M-11168-001S	951
PAF15-07020001	66M-11631-00-96	951-986
PAF15-07020005	93450-15023	951-986
PAF15-07020006	634-11633-00	951-986
PAF15-07020100	66M-11650-00	951
PAF15-07030000	66M-11411-00	951-985
PAF15-07030003	66M-11536-10	953
PAF15-07030005	90170-28M37	953
PAF15-07030006	93102-25014	957
PAF15-07030006	93102-35M51	951
PAF15-07030007	93102-25M52	951
PAF15-07040000	66M-11111-01-1S	953
PAF15-07040001	66M-12111-00	953
PAF15-07040002	66M-12121-00	953
PAF15-07040004	66M-12116-00	953
PAF15-07040005	66M-12113-00	953
PAF15-07040006	30X-12117-00	957-961-963- 967-969-971- 975
PAF15-07040007	30X-12118-00	953-957-961- 963-967-969- 971-975
PAF15-07040008	93102-18M21	948-953
PAF15-07040009	90387-13001	953
PAF15-07040011	90387-13002	953
PAF15-07040012	90387-13M56	948-953
PAF15-07040016	66M-13329-10	953
PAF15-07040017	90201-13201	948-953
PAF15-07040018	66M-11537-00-94	953
PAF15-07040200	66M-12170-00	953
PAF15-07040301	66M-12151-10	953
PAF15-07040303	62Y-12159-00	953-961-967- 957
PAF15-07040304	62Y-12158-00	953-957-961- 963-967-969- 971-973-975
PAF15-07040500	66M-13300-10	953
PAF15-07050001	66M-11191-00-1S	953
PAF15-07050002	66M-11356-00	953
PAF15-07050003	90480-10M16	953
PAF15-07050004	69M-E5363-00	939-948 949-953-955- 959-963-965- 969-971-973- 975-977-979- 981-982
PAF15-07050006	30X-12117-00	953
PAF15-07060001	6J8-81960-00	890
PAF15-07070000	66M-85550-00	883
PAF15-07070100W	66M-85550-10	883
PAF15-07080000	61N-24560-00	859
PAF15-07080002	61N-24521-00	859
PAF15-07090000	66M-14301-00	870
PAF15-07090000W	66M-14301-00	870

REF	OEM	
PAF15-07130001	63V-15716-00	888
PAF15-07130107	63V-15713-00	887
PAF15-07130201	63V-15714-00	888
PAF15-07130202	63V-15741-00	887
PAF15-07130203	63V-15767-00	887
PAF15-07130204	63V-15784-00	887
PAF15-07140000	66M-24410-11	863
PAF15-07150100W	66M-81800-00, 01, 02	884
PAF15-09000000	6G1-24306-55	858
PAF15-09000000	6Y1-24306-55	858
PAF15-10000002	6YJ-24167-00	858
PAF15-10000003	6Y1-24268-00	859
PAF15-10010000	6YJ-24610-00	858
PAF15-10010000	6YJ-24610-01	858
PAF15-10020000	6YJ-24260-00	859
PAF15-10020000	6YJ-24260-10	859
PAF15-11000020W	703-48293-10	908
PAF15-11020000W	63V-61350-00	909
PAF15-13000000W	703-48230-10	899
PAF15-13000000W	703-48230-11	899
PAF15-13000000W	703-48230-12	899
PAF15-13000000W	703-48230-13	899
PAF15-13000000W	703-48230-14	899
PAF15-13000000W	703-48230-15	899
PAF15-13000000W	703-48230-16	899
PAF15-13000000W	703-48230-17	899
PAF15-13000000W	703-48230-18	899
PAF15-13000000W	703-48230-1A	899
PAF15-13000000W	703-48230-20	899
PAF15-13000000W	703-48230-21	899
PAF15-13000100W	688-82586-21	906
PAF15-13000200W	703-82510-12	888
PAF15-13000300W	703-83383-00	905
PAF15-13000300W	703-83383-01	905
PAF15-13000300W	703-83383-02	905
PAF15-13000300W	703-83383-10	905
PAF15-13000300W	703-83383-11	905
PAF15-13000500W	703-48261-01	902
PAF15-13010010W	703-48245-00	909
PAF15-13020007W	703-48152-00	908
		941-943-947-948-953-957-961-963-967-969-971-973-975-981
PAF166-010003	51Y-12119-00	
PAF2.6-00000003	69M-45113-A0	941-984-985
PAF2.6-00000004	69M-24575-00	859
PAF2.6-02000003L	69M-44361-10	1041
PAF2.6-02000003S	69M-44361-00	1041
PAF2.6-03000001	69M-G5311-00-4D	1041
PAF2.6-03000002	6L5-45317-09	1041
PAF2.6-03000003	6L5-45316-09	1041
PAF2.6-03000004	93103-09M41	1041
PAF2.6-03000007	69M-G5315-A0	1041
PAF2.6-03000008	69M-G5321-00-94	1041
PAF2.6-03000009	93210-05001	1041
PAF2.6-03000010	69M-G4323-00	923-1041-929
PAF2.6-03000011L	69M-G5511-10	1041
PAF2.6-03000011S	69M-G5511-00	1041
PAF2.6-03000012	93440-08819	1041
PAF2.6-03000013	93604-07M13	1041
PAF2.6-03000013	93604-09068	1093
PAF2.6-03000013		848-929
PAF2.6-03000014	69M-G4311-00	848-922-929-1041
PAF2.6-03000015	6L5-44322-00	929-1041
PAF2.6-03000018	6L5-45551-00	1041
PAF2.6-03000019	6L5-45560-00	1041
PAF2.6-03000020	69M-G5635-00	1041
PAF2.6-030000201	6L5-45631-00	1041
PAF2.6-03000021	90201-13198	1041
PAF2.6-03000100	6L5-44352-00	1041
PAF2.6-03000202	6L5-45631-00	1041
PAF2.6-03000300	69M-G5361-00-4D	1041
PAF2.6-03000301	69M-G5361-00-4D	1041
PAF2.6-03000302		1041
PAF2.6-03010000	6E0-45949-00	1045
PAF2.6-03010000	6L5-45943-00-EL	1041-1144
PAF2.6-03020000L	69M-65300-11-4D	1037
PAF2.6-03020000L	69M-G5300-01-4D	1041
PAF2.6-03020000S	69M-65300-01-4D	1037

REF	OEM	
PAF2.6-03020000S	69M-G5300-00-4D	1041
PAF2.6-04000001	69M-11181-00	941-983-985
PAF2.6-04000002	69M-12154-00	941
PAF2.6-04000003	90201-23008	941
PAF2.6-04000004	69M-11351-A0	939-1033
PAF2.6-04000005	69M-11193-A0	941
PAF2.6-04000006	69M-E1191-00-1S	941
PAF2.6-04000007	90445-09808	941
PAF2.6-04000008	69M-G2743-00	939
PAF2.6-04000009	6G8-44532-00	939
PAF2.6-04000015	90445-07MA3	1003
PAF2.6-04000100	69M-12170-01	941
PAF2.6-04000200	69M-14301-21	869
PAF2.6-04000600	69M-85640-00	882
PAF2.6-04010001	93102-20070	987
PAF2.6-04010001	93102-20108	939-945-947
PAF2.6-04010100	69M-E1311-00-1	939
PAF2.6-04010102	69M-15361-00	939
PAF2.6-04020001	69M-E1631-01-96	941-986
PAF2.6-04020005	69M-E1633-00	941-986
PAF2.6-04020006	93450-13130	941
PAF2.6-04020100	69M-11650-00	941
PAF2.6-04030000	69M-11400-00	941-985
PAF2.6-04040001	69M-E2155-00	941
PAF2.6-04040100	69M-E1111-00-1S	941
PAF2.6-04050001	69M-E5111-00-1S	939
PAF2.6-04050100	69M-E3102-00	939
PAF2.6-04060000	69M-E5396-00-5B	939
PAF2.6-04060001	69M-E5396-00	939
PAF2.6-04060002	93210-09004	939
PAF2.6-04070200	6BG-41134-00	877
PAF20-02000005	6AH-44368-00	1051
PAF20-02000007	6AH-44365-00	1051
PAF20-02000101L	6AH-44361-11	1051
PAF20-02000101S	6AH-44361-01	1051
PAF20-04000000L	6AH-45300-10-4D	1038
PAF20-04000000L	6AH-45300-10-8D	1038-1050
PAF20-04000000S	6AH-45300-00-4D	1038
PAF20-04000000S	6AH-45300-00-8D	1038-1050
PAF20-04000001	69G-45315-A0	1050
PAF20-04010001	69G-45331-01-CA	1050
PAF20-04020000L	6AH-44150-10	1050
PAF20-04020000S	6AH-44150-00	1050
PAF20-04030000L	6AH-45510-10	1051
PAF20-04030000S	6AH-45510-00	1051
PAF20-04040000	6AH-44311-00	922-1051
PAF20-05000000	6AH-W009B-02-1S	957
PAF20-05000002	90105-090006	955
PAF20-05000003	6AH-46241-00	957-1031
PAF20-05000016	6AH-12481-00	955
PAF20-05000027	6AH-11536-00	957
PAF20-05000028	6AH-11557-00	957
PAF20-05000029	90170-30003	957
PAF20-05000036	90480-06M19	957
PAF20-05000100	6AH-85580-00	883
PAF20-05000200	6AH-85510-00	894
PAF20-05000300	6AH-85540-00	892
PAF20-05000500	6AH-85550-00	883
PAF20-05000500W	6AH-85550-10	883
PAF20-05000600	6AH-41113-01-1S	955
PAF20-05000602	6AH-41114-00	955
PAF20-05000700	6AH-12413-00-1S	955
PAF20-05000702	6AH-12414-00	849-915-955
PAF20-05000900W	6AH-81800-00, 01	884
PAF20-05010000	6AH-15100-00	955
PAF20-05010003	6AH-11416-00	957
PAF20-05010007	97013-06040	955
PAF20-05020001	6AH-11631-00	957-986
PAF20-05020002	93450-17129	957-986
PAF20-05020003	137-11633-10	957-986
PAF20-05020004	6AH-11411-00	957-985
PAF20-05020100	6AH-11603-00	957-986
PAF20-05020200	6AH-11650-10	957
PAF20-05030001	6AH-12111-00	957
PAF20-05030002	6AH-12121-10	957
PAF20-05030003	62Y-12116-00	957
PAF20-05030004	3YF-12113-00	957
PAF20-05030005	93102-22010	957
PAF20-05030006	90387-13006	957
PAF20-05030007	90501-120A5	957

REF	OEM	
PAF20-05030008	6AH-12279-00	957
PAF20-05030009	6G8-11197-01	971-973
PAF20-05030009	6G8-11197-A0	955
PAF20-05030010	6AH-13329-10	957
PAF20-05030011	90201-15423	957
PAF20-05030012	6AH-11537-00	957
PAF20-05030013	90201-08784	957
PAF20-05030100	6AH-11111-10-1S	955
PAF20-05030200	6AH-12170-00	957
PAF20-05030301	6AH-12151-00	957
PAF20-05030400	6AH-13300-00	957
PAF20-05040000	6AH-11191-001S	955
PAF20-05040002	6AH-11356-00	955
PAF20-05040003	6AH-11168-00	955
PAF20-05040004	6AH-11169-00	955
PAF20-05040005	62Y-14485-00	963
PAF20-05040005	6AH-11372-00	955
PAF20-05050000	6AH-24410-00	863
PAF20-07000100W	63AH-61350-00	909
PAF25-00000011	90105-10M12	1053
PAF25-00000014	93608-12063	1001-1005-1007-1009
PAF25-00000014	99530-08012	959-965-969-971-973-975
PAF25-01000001	90386-52M02	911
PAF25-01000004	90386-44M03	911
PAF25-02000019	90202-12060	1055-1059-1063-1067-1117-1121
PAF25-02010007	67C-15312-00	1034
PAF25-03000007	90387-06M69	911
PAF25-03000008	90445-09068	959-965-975
PAF25-03000009	90445-09095	959-965-975
PAF25-03000009	90445-09104	963
PAF25-03000011	90445-09105	959
PAF25-03000011	90445-09251	963
PAF25-04000001	61N-45311-02-4D	1053
PAF25-04000003-2	61N-45587-00-10	1055
PAF25-04000003-3	61N-45587-00-11	1055
PAF25-04000003-4	61N-45587-00-12	1055
PAF25-04000003-5	61N-45587-00-13	1055
PAF25-04000003-6	61N-45587-00-14	1055
PAF25-04000003-7	61N-45587-00-15	1055
PAF25-04000004-3	61N-45567-12	1053
PAF25-04000004-5	61N-45567-14	1053
PAF25-04000005	61N-45551-00	1053
PAF25-04000008	65W-45331-00-5B	1055
PAF25-04000012	65W-44176-00	1055
PAF25-04000013	61N-45127-00	1055-1105
PAF25-04000016	65W-44328-00	1055
PAF25-04000017	61N-44362-10	1055-1105
PAF25-04000017S	61N-44362-00	1055-1105
PAF25-04000021	61N-45214-00	1053
PAF25-04000023	61N-45215-00	1053
REC61N-45510-10	61N-45510-10	1055
PAF25-04030000S	65W-44150-00	1055
PAF25-04050000	61N-44311-01	1055
PAF25-04050001	61N-44311-01	929-930-931-922-1055-1105
PAF25-04050003	93210-45161	850-929-930-931-1055-1105
PAF25-04060000	648-45633-11	1053
PAF25-04060003	664-45631-02	1053
PAF25-04060007	90201-20417	1053
PAF25-04070005-1	61N-45577-00-10	1053-1105
PAF25-04070005-3	61N-45577-00-12	1053
PAF25-04090000L	65W-45300-01-4D	1038-1053
PAF25-04090000S	65W-45300-00-4D	1053
PAF25-04090000S	65W-45300-01-4D	1038
PAF25-05000002	90119-09M00	959-965-975
PAF25-05000004	65W-11356-00	959
PAF25-05000005	65W-11191-00-94	959
PAF25-05000007	65W-15121-00	959
PAF25-05000021	65W-11536-10	961-967
PAF25-05000024	90280-04M06	967
PAF25-05000100	5GH-13440-00	959
PAF25-05010103	65W-11168-00	959
PAF25-05010107	65W-13286-00	959
PAF25-05010108	65W-11169-00	959
PAF25-05010111	65W-41114-00	917-959
PAF25-05010113	62Y-11372-01	959
PAF25-05010113	62Y-12481-10	971-973

REF	OEM	REF	OEM	REF	OEM			
PAF25-05010201	65W-85790-00	879	PAF4-03000018	6E0-44315-A0	1095	PAF4-04030000	67D-11400-00	943-985
PAF25-05010302-2	62Y-11416-10	961-967	PAF4-03000018		848-929	PAF4-04040000	68D-E2170-00	943
PAF25-05020002	93102-35M47	961-967	PAF4-03000019	68D-G4311-01	922-1043	PAF4-04050100	68D-E3102-00	945
PAF25-05020003	93102-43M42	961-963-967-969-971-975	PAF4-03000019	6E0-44311-00	1095	PAF4-04050200	68D-E5111-00-1S	945
		961-963-967-969-971-975	PAF4-03000019		929	PAF4-04060000	6EE-E5396-00-CA	945
PAF25-05020106	93450-17129	961-967-969-971-975-986-997	PAF4-03000020	68D-G4328-00	1043-1045	PAF4-04060001	68D-E5396-00-5B	945-947
PAF25-05020204	62Y-11654-00	961-967	PAF4-03000020	6E0-44328-00	1095	PAF4-04060002	93210-35537	939-945
PAF25-05020204	6AH-11654-00	957	PAF4-03000021	67D-44366-00	1043-1045	PAF4-04060004	93101-10M14	1043-1045
PAF25-05020204	6C5-11654-00	963-969-971-973-975	PAF4-03000021	6E0-44366-00	1095	PAF4-04060004	93102-10004	945-947
PAF25-05020310	65W-11665-00	961	PAF4-03000021	6R0-44366-00	1041	PAF4-04070000	68D-E2413-00-1S	947
PAF25-05040000	65W-11181-30	959-983-985	PAF4-03000022	68D-G5978-00	1041-1043-1045	PAF4-04070003	68D-E1325-00	848-849-850-851-852-853-854-855-941-943-947
PAF25-05050001	67C-12111-00	961-967	PAF4-03000025	6L5-45987-01	1095			
PAF25-05050002	62Y-12121-00	961-967-975			1144	PAF4-04070100	68D-E2413-001S	943
PAF25-05050003	62Y-12116-00	961-963-967-969-971-975	PAF4-03000026	90201-08M54	1041-1043-1045-1095-1144	PAF4-04080005	67D-12111-00	943
		959-963-965-969-971-973-975			1095 1144	PAF4-04080006	67D-12121-00	943-948
PAF25-05050006	90109-06M65	961-967-975	PAF4-03010000	67D-45560-00	1043-1045-1131	PAF4-04080007	68T-12116-00	943-947-948
PAF25-05050009	62Y-12238-00	961-975	PAF4-03020000L	68D-G4150-10	1043	PAF4-04080008	68D-E2113-00	941-943
PAF25-05050012	62Y-12231-00	961-975	PAF4-03020000L	68X-G4150-10	1045	PAF4-04080009	68D-E2155-00	943
PAF25-05050013	93210-12MG9	961-967-975	PAF4-03020000S	68D-G4150-00	1043	PAF4-04080101	68D-E1111-10-1S	943
PAF25-05050014	93210-14515	961-967-975	PAF4-03020000S	68X-G4150-00	1045	PAF4-04090000	67D-24410-03	863
PAF25-05050015	93210-33MH2	961-967-975	PAF4-03030002	67D-45631-01	1043-1045	PAF4-04120005	6L5-24251-00	848-859-861
PAF25-05050016	93605-14143	961-967-975	PAF4-03030002	67D-45631-01	1043-1045	PAF4-04120100	67D-24610-00	858
PAF25-05050017	65W-11537-01	961	PAF4-03030003	90501-10064	1041	PAF4-04120100	67D-24610-02	858
PAF25-05050018	90201-10144	969	PAF4-03040000	67D-45570-00	1043-1045-1131	PAF4-04120100	67D-24610-03	858
PAF25-05050018	90201-10M06	961-967-975	PAF4-03050001	68D-G5361-00-4D	1043-1045	PAF4-04120100	67D-24610-04	858
	90109-08M63	961-967-975	PAF4-03050001	6E0-45361-01-4D	1095	PAF4-04120100	68D-24610-10	858
PAF25-05050021	93102-37004	957	PAF4-03050002	93101-13M12	1041-1043	PAF4-04120103	62A-24634-00	858
		961-963-967-969-971-973-975	PAF4-03060000	6E0-44352-00	848-1043	PAF4-04130100	6G1-15755-00	887
PAF25-05050021	93102-37M40	961	PAF4-03070000	6E0-45943-01	1045	PAF4-04130100	6G1-15779-00	887
		961	PAF4-03080000	6E0-45943-01-EL	1043-1144	PAF4-04140000	67D-14301-03	869
PAF25-05050200	65W-12171-10	961	PAF4-03080000	6L5-45616-00	1041-1043	PAF4-05000300	646-24251-01	859
PAF25-05050300	65W-12151-00	961	PAF4-03080000	6L5-45646-00	1045	PAF4-05000300	646-24251-02	859
PAF25-05050400	65W-13300-00	961	PAF4-03080000		1144	PAF4-05000300		848-861
PAF25-05070000	65W-14901-12	870	PAF4-0310000L	68D-65300-11-4D	1037	PAF40-02000007	67C-45123-00	1032
PAF25-05070019	6H4-14548-00	875	PAF4-0310000L	68D-G5300-10-4D	1043	PAF40-02010007	68G-41134-00	1033
PAF25-05080004	65W-14457-10	1032	PAF4-0310000S	68D-65300-03-4D	1037	PAF40-04000000L	66T-45300-10-4D	1039
PAF25-05120000	65W-85570-01	881	PAF4-0310000S	68D-65300-00-4D	1043	PAF40-04000000L	66T-45311-13-8D	1039
	62Y-24410, 01, 02, 03, 04	856	PAF4-04000000	680-WE090-11-15	943	PAF40-05000053	90445-10M40	977
PAF25-05130000	62Y2441000, 1, 2, 3, 4	856	PAF4-04000001	90105-08M76	939	PAF40-05040003	62Y-12279-00	975
		856	PAF4-04000001	97095-08020	1085-1087-1089-1091	PAF40-05040006	67C-11537-01	967
PAF25-05130000	62Y-244100400	865	PAF4-04000001	97095-08020-00	945	PAF40-05070002	62Y-14485-00	965-969-971-975
	62Y-24471-00	865	PAF4-04000002	68D-11351-A0	945-1033	PAF40-13000000EI		899
PAF25-07000007W	703-48345-01	902	PAF4-04000002	99510-10114	943	PAF6-00000001	6BX-45113-00	929-947-984
PAF4-00000001	90387-06806	1043-1045	PAF4-04000003	90201-266P2	943	PAF6-03000002	68X-44322-00	929-1045
PAF4-00000001	90387-06M14	1095	PAF4-04000004	90201-08818	945	PAF6-04000001	6BX-11351-00	947
PAF4-00000006	67D-45113-A0	943-984-985	PAF4-04000006	90201-08818-00	939	PAF6-04000002	6BX-11181-00	947-983
PAF4-01090100	6EG-G2138-00	909	PAF4-04000006	90201-08818-00	939	PAF6-04000003	6BX-12154-00	947
PAF4-01090100	6G1-42138-00,01	909	PAF4-04000006	90430-08143	965-977-979	PAF6-04000004	6BX-E1191-00-5B	947
PAF4-01090300	68D-G2177-10	911	PAF4-04000006	90430-08800	947	PAF6-04000005	6BX-11356-00	947
PAF4-01090300	6EE-G2177-00	911	PAF4-04000006	90430-08800-00	943	PAF6-04000009	6G0-82519-00	947
PAF4-01090401	682-82556-00	894	PAF4-04000006		848-850	PAF6-04000020	6BX-F4323-00	947
PAF4-02040001	68D-G4360-10	1043	PAF4-04000007	68D-E5362-00	945	PAF6-04010004	6BX-E1168-00	947
PAF4-02040001S	68D-G4360-00	1043	PAF4-04000009	68D-E1169-A0	945	PAF6-04030000	6BX-E2170-00	947
PAF4-02040002	68D-G4365-00	1041-1043	PAF4-04000011	68D-E2414-A0	848-915-941-943-947	PAF6-04050001	6BX-12111-00	947
PAF4-03000001	68D-G5300-11-4D	1043	PAF4-04000012	90445-09807	943	PAF6-04050002	6AU-12121-00	947
PAF4-03000002	6E0-45317-09	1043-1045	PAF4-04000014	67D-11181-A0	943-983-985	PAF6-04050003	6OR-12113-00	947
PAF4-03000003	6E0-45316-09	1043-1045	PAF4-04000015	67D-12154-00	943	PAF6-04050004	6BX-E2155-00	947
PAF4-03000004L	68D-G5511-10	1045	PAF4-04000017	68D-E1193-A0	943	PAF6-04050100	6BX-E1111-00-1S	947
PAF4-03000004L	6E0-45511-11	1043	PAF4-04000018	67D-11191-00	943	PAF60-02000007	6C5-44361-00	1071
PAF4-03000004S	68D-G5511-00	1045	PAF4-04000019	90280-04M06	961-975	PAF60-04000000	69W-45300-00-4D	1039
PAF4-03000004S	6E0-45511-01	1043	PAF4-04000019	90467-08004	1009	PAF60-04000000	69W-45300-00-8D	1039
PAF4-03000005	90467-08M01	1043-1045-1095	PAF4-04000030	90467-09M09	959-991	PAF60-04000000	69W-45300-01-8D	1039
PAF4-03000006	90201-11M49	1045-1093	PAF4-04000030		848-849-851	PAF60-04000000	69W-45300-04-8D	1069
PAF4-03000006	90204-11M49	1043-1095	PAF4-04000033	90105-08046-00	943	PAF60-04000001	69W-45301-00-8D	1069
PAF4-03000007	6E0-45551-00	1043	PAF4-04000034	90105-08M36	941-947-948	PAF60-04000002	69W-45551-00	1069
PAF4-03000008	67D-45635-00	1043-1045	PAF4-04000034	90105-08M36-00	943	PAF60-04000003	62Y-44151-00	1061-1065-1069
PAF4-03000011	68D-G5315-A0	1043-1045	PAF4-04000036	6EE-E5362-00	945	PAF60-04000008	63D-45344-00	1071
PAF4-03000011	6E0-45315-A0	1095	PAF4-04000038	67D-85640-00	882	PAF60-04000101	63D-45321-00	1063-1067-1071
PAF4-03000012	68D-G5321-00	1043-1045	PAF4-04010004	93102-25090	945	PAF60-04000500	62Y-45571-00	1069
PAF4-03000012	6E0-45321-01-5B	1095	PAF4-04010100	68D-E1311-02-15	945	PAF60-04000600	69W-45560-00	1069
		1041-1043-1045-1095			941-943-945-947-948-955-1001-1003-1007	PAF60-04010000	69W-45501-00	1071
PAF4-03000013	93604-18080	929-931-1043-1095	PAF4-04010102	650-24378-00	943	PAF60-04020001	63D-45611-00	1061-1065-1069
PAF4-03000015	6E0-44323-00	1095	PAF4-04020001	68D-E1631-00-96	943	PAF60-04020002	90501-18001	1061-1065-1069
PAF4-03000016	93604-09066	848-929-1043-1045-1095	PAF4-04020005	68D-E1633-00	943-986	PAF60-04020003	62Y-45631-00	1065-1069
PAF4-03000017	6E0-44322-02	1043	PAF4-04020006	93450-14088	943-986	PAF60-04020005	63D-45635-00	1061-1065-1069
PAF4-03000018	68D-G4315-A0	1043	PAF4-04020100	67D-11650-00	943	PAF60-04030000	63D-45361-02-8D	1065-1069
PAF4-03000018	6BX-G4315-01	1045	PAF4-04020200	68D-E1631-00-96	943-986	PAF60-04000401	63D-44311-00	922-931-1067-1071
						PAF60-06000000	6C5-43800-11, 12	898

REF	OEM	
PAF8-05000022	90119-06MA3	955
PAF8-05030006	7NJ-12117-00	941-943
PAF8-05030007	7NJ-12118-00	941-943-947
PAGB/T1099-3X5X13	90280-03017	969
PAGB/T1099-3X5X13	90280-03M01	948-953-957-963-971-973
PAGB/T276-6004C2	93306-004U0	1095
PAGB/T276-6004C2	93306-004YH	1047
PAGB/T276-6004C2	93306-205YD	945
PAGB/T276-6006/P6	93306-00612	1053
PAGB/T276-62/22/P6	93306-272Y2	939
PAGB/T290F-2020	93315-220V7	1055
PAGB/T345.2-D32.5XD1	93210-35537	947
PAGB/T3452.1-13X2	93210-13M63	848-849-852-853-854-855-948-955-963-969-971-973
PAGB/T3452.1-32.5X1.8		849-850-851-852-853-854-855
PAGB/T5287-6	90201-06M94	948-953
PAGB/T5782-2000S	PAGB/T5782-2000S	1043
PAGB/T5782-M6X125	95895-06035	1053
PAGB/T5782-M6X125	97013-06035	961-1043
PAGB/T5782-M6X25	97095-06025	977-981-997
PAGB/T5782-M6X35	90119-06MA5	959-971-973-999-1007
PAGB/T5782-M6X45	90105-06M25	943
PAGB/T5782-M6X45	947395-06040	1099
PAGB/T5782-M8X35	65W-08M87	959
PAGB/T5782-M8X80	90119-08M01	959
PAGB/T5783-M5X10	97013-05010	947
PAGB/T5783-M5X12	68D-E5362-00	951
PAGB/T5783-M5X12	90119-06M48	1053
PAGB/T5783-M5X12	90201-08818	951
PAGB/T5783-M5X12	90465-08M99	939
PAGB/T5783-M5X12	92995-06600	953-1003
PAGB/T5783-M5X12	93102-25090	951
PAGB/T5783-M5X12	93306-205YD	951
PAGB/T5783-M5X12	95895-06016	1045-1047
PAGB/T5783-M5X12	95895-06016-00	1043
PAGB/T5783-M5X12	95895-06020	1041
PAGB/T5783-M5X12	97013-06016	953-989-995
PAGB/T5783-M5X12	97013-06045	939
PAGB/T5783-M5X12	97095-05012	959
PAGB/T5783-M5X12	97095-0512	951
PAGB/T5783-M5X12	97095-06035	953
PAGB/T5783-M5X12	97575-08550-00	951
PAGB/T5783-M5X16	97095-05016	1093
PAGB/T5783-M6X10	97095-06010	965-1099-1113
PAGB/T5783-M6X12	95817-06012	939
PAGB/T5783-M6X12	95817-06012-00	945
PAGB/T5783-M6X12	97013-06012	957
PAGB/T5783-M6X14	90119-06M80-00	945
PAGB/T5783-M6X14	95895-06012	1045
PAGB/T5783-M6X16	90105-06039	941
PAGB/T5783-M6X16	90105-06M14	943
PAGB/T5783-M6X16	92995-06600	1121
PAGB/T5783-M6X16	97090-06014	1093
PAGB/T5783-M6X16	97095-06016	988-989-991-993-997-1001-1005-1077-1089
PAGB/T5783-M6X20	65W-12228-00	959
PAGB/T5783-M6X20	90119-06MA2	947-993
PAGB/T5783-M6X20	90119-06MA3	959
PAGB/T5783-M6X20		939-941-947-948-959-963-965-969-971-973-975-977-981-999-1003-1007-1049-1097-1101
PAGB/T5783-M6X20	97095-06020	943
PAGB/T5783-M6X20	97395-06020	1099
PAGB/T5783-M6X20	97575-06520	1051
PAGB/T5783-M6X20	97595-06520	953-955
PAGB/T5783-M6X20	65W-12228-00	959
PAGB/T5783-M6X25	90119-06MA3	955-959-1001
PAGB/T5783-M6X25	90119-06MA5	959
PAGB/T5783-M6X25	90119-08MA5	1001
PAGB/T5783-M6X25	97513-06525	953
PAGB/T5783-M6X30	90119-06M04	993
PAGB/T5783-M6X30	90119-06MA4	1001
PAGB/T5783-M6X30	90119-06MA5	963

REF	OEM	
PAGB/T5783-M6X30	95895-06035	1051
PAGB/T5783-M6X30	970-95-06030	997
PAGB/T5783-M6X30	97095-06030	948-979-981-1093-1096
PAGB/T5783-M6X35	90105-06035	957
PAGB/T5783-M6X35	90119-06MA5	1009
PAGB/T5783-M6X35	90119-06MAS	959
PAGB/T5783-M6X35	95895-06012	1093-1097
PAGB/T5783-M8X14	97095-08014	939-947
PAGB/T5783-M8X14	97095-08014-00	943
PAGB/T5783-M8X20	97095-08020	947
PAGB/T5783-M8X20	97095-08020-00	945
PAGB/T5783-M8X25	90105-081A7	957
PAGB/T5783-M8X25	97075-08025	977
PAGB/T5783-M8X25	97080-08025	1047-1049-1051-1101
PAGB/T5783-M8X25	97095-08025	1057-1061-1065-1069-1079-1083-1085-1089
PAGB/T5783-M8X30	97575-08530	1051
PAGB/T5783-M8X35	90101-08001	1001
PAGB/T5783-M8X35	97075-08035	1047
PAGB/T5783-M8X35	97095-08035	1061-1065-1069
PAGB/T5787-1986	97575-08550-00	945
PAGB/T6182-M5	90185-05002	1047-1051-1073-1075-1079-1081-1087-1089-1091-1101
PAGB/T818-M4X10	97607-04210	955-963-965-969-971-973-975
PAGB/T818-M4X6	98503-04066-00	945
PAGB/T818-M5X12	97095-05012	965-971-973-975-979
PAGB/T818-M5X25	97880-05025	941-947-971-973
PAGB/T818-M5X25	97880-05025-00	943
PAGB/T818-M5X25	98980-05025	955
PAGB/T818-M6X16	98580-06016	1115
PAGB/T820-M4X12	98780-04015	981-1005
PAGB/T820-M4X12	98780-04016	955-977-1003
PAGB/T820-M5X20	90152-05011	1051
PAGB/T820-M5X25	90152-05M03	1047
PAGB/T820-M5X25	90152-05M04	1101
PAGB/T820-M5X30	90142-05M06	1057
PAGB/T820-M5X30	90151-05M05	1053
PAGB/T820-M5X30	90152-05010	1061-1069
PAGB/T820-M5X30	90152-05M06	1065
PAGB/T820-M5X30		1115
PAGB/T845-ST4.2X16	97780-40112	1099
PAGB/T845-ST4.8X9	97780-50510	1099
PAGB/T848-6	92903-06600	971-973
PAGB/T861.1-6	92990-06300	1051-1041-1045-1047-1053-1093-1097
PAGB/T879.4-3X20	91690-30010	1001
PAGB/T889.1-2000	90185-05002	1053
PAGB/T889.1-M5	95380-05600	1057-1061-1065-1069-1115
PAGB/T893.1-22	93420-22M03	1045
PAGB/T896-86	93430-06005	1093
PAGB/T896-86	99001-06600	1041-1043-1095
PAGB/T896-9	93430-10M00	910
PAGB/T896-9	99080-10600	910
PAGB/T91-1.6X12	91490-25030	1041-1043-1045-1095
PAGB/T91-1.6X12	91490-30022	1053-1105-848-849-850-1144
PAGB/T91-2.5X20	91490-30020	1099
PAGB/T96-10	90201-10M01	1051-1099
PAGB/T96-6	92995-06600	963
PAGB/T97.1-10	92995-10100	1057
PAGB/T97.1-14	92990-14200	1105-1107-1144
PAGB/T97.1-5	92995-05600	959-965-975
PAGB/T96-6	92885-06600	945-955-965-975-953-997-1059-1093-1097-1099-1117
PAGB/T96-6	97095-06016	1121

REF	OEM	
PAGB/T96-6	92995-06600	939-941-943-947-948-963-965-969-971-973-977-979-981-988-989-991-1001-1005-1045-1047-1049-1073-1077-1089-1101-1105
PAGB/T97.1-8	66M-11328-00	961
PAGB/T97.1-8	66M-11356-00	959
PAGB/T97.1-8	92955-08600-00	945
PAGB/T97.1-8	92990-08600	1117
PAGB/T97.1-8	92990-14200	1053
PAGB/T97.1-8	92995-05600	951-971-973
PAGB/T97.1-8	92995-06600	953-993-995-999-1007
PAGB/T97.1-8		947-977-982-1079-1083-1085-1087-1089-1091-1093-1113-1119-1125
PAGB/T97.1-8	92995-10600	1053-1057-1061-1065-1069-1073-1075-1085
PAGB/T97.1-8	93102-20108	951
PAGB/T97.1-8	97595-06520	951-959-961-1041
PAGBT3452.1-97.5X1.8	65W-15663-00	959
PAHI-CAP32004JRKYO	93332-000W5	1055
PAHT-2.5X60	90465-11M10	948-959-965-975-977-981-1059-1063-1067-1071-1073-1077-1079-988-991-993-997-1003-1005-1007
PAHT-2.5X60	90467-06016	1007
PAHT2.5X50	90465-11M10	955
PAJASOF404-19-033	93210-33M49	1087-1089
PAJASOF404-19-033	93210-33M85	1041
PAJASOF404-19-033		848-929
PAJASOF404-31-045	93210-44398	1101
PAJASOF40424-050	93210-48001	1071
PAJASOF40431-025	93210-24M79	848-849-853-854-939-949-955-959-963-965-975-977-979-981-982-945-948-953-969-971-973
PAJASOF40435-022	93210-24M79	910
PAJB/T9740.1-M6	93700-06M03	939
PAJISB2401P48	93210-48214	1041-1043
PAKOYOH-CAP322/32	93332-00092	1069
PANTN16003EY	93316-003Y0	1041
PANTN6205C3	93306-205B2	947
PAT15-04010202	624-14485-00	1001
PAT15-04010202	6H1-14485-00	939
PAT20-13000500W	703-48261-11	902
PAT36-04000023	90465-06M86	947
PAT40-02000002	663-44367-00	1059-1063-1067-1071-1073-1077-1117-1121
PAT40-04000002	6H4-45536-00	1059-1063-1067-1071
PAT40-04000003-1	663-45587-01	1059-1063-1067-1071
PAT40-04000003-1	663-45587-01-10	1117
PAT40-04000003-2	663-45587-01-12	1117
PAT40-04000003-2	663-45587-10	1059-1063-1067-1071
PAT40-04000003-3	663-45587-01-15	1117
PAT40-04000003-3	663-45587-20	1059-1063-1067-1071
PAT40-04000003-5	663-45587-01-30	1117
PAT40-04000003-5	663-45587-40	1059-1063-1067-1071
PAT40-04000004-1	663-45567-01	1057-1061-1065-1069
PAT40-04000004-1	663-45567-01-10	1115
PAT40-04000004-5	663-45567-01-30	1115
PAT40-04000004-5	663-45567-40	1057-1061-1065-1069
PAT40-04000007	66T-45321-00	1059
PAT40-04000008	90201-27M00	1059-1063-1067-1071
PAT40-04000009	66T-45344-01	1059-1063-1067

REF	OEM	
PAT40-04000014	63D-45375-00	1059-1063-1067-1071
PAT40-04000022	63D-45214-00	1057-1061-1065-1069
PAT40-04000023	63D-45215-00	1057-1061-1065-1069
PAT40-04000027	93332-00079	1117
PAT40-04000201	66T-44311-00	922-1059-1063
PAF40-04010000S	67C-45501-00	1059-1063-1133-1134
PAF40-04010000L	67C-45501-10	1059-1063-1133-1134
PAT40-04040001	68G-44341-00	1071
PAT40-04050002	90501-15M01	1111
PAT40-04050005	67C-45633-00	1065-1069
PAT40-04050007	90201-22008	1069
PAT40-04060005-2	63D-45577-10	1057-1061-1065-1069
PAT40-04060005-3	63D-45577-20	1057-1061-1065-1069
PAT40-04060005-4	63D-45577-30	1057-1061-1065-1069
PAT40-04060005-5	63D-45577-40	1057-1061-1065-1069
PAT40-05000100	6AH-82560-00	879
PAT40-10000000	65W-43800-00-4D	898
PAT40-10000000	65W-43800-01-4D	898
PAT40-10000000	65W-43800-02-4D	898
PAT40-10000000	65W-43800-03-4D	898
PAT40-10000000	65W-43800-20-4D	898
PAT40-10000000	65W-43800-21-4D	898
PAT40-10000000	65W-43800-22-8D	898
PAT40-10000000	65W-43800-23-8D	898
PAT40-10020500	65W-43880-00, 01	895
PAT85-00000012	90105-10M00	1079-1081-1085-1087-1089-1125-1127
PAT85-00000012	90105-16M67	1073-1075
PAT85-00000017	90386-18M35	911
PAT85-01010203	90386-10M16	911
PAT85-01020003	90386-30M78	911
PAT85-01020005	90386-30M77	911
PAT85-040000004-B	688-45567-01	1073-1075
PAT85-05000023	6C5-82105-01	887
PAT85-05030300	6AH-81960-00	890
PAT85-08010000W	703-48205-11	899
PAT85-08010000W	703-48205-12	899
PAT85-08010000W	703-48205-13	899
PAT85-08010000W	703-48205-14	899
PAT85-08010000W	703-48205-15	899
PAT85-08010000W	703-48205-16	899
PAT85-08010000W	703-48205-17	899
PAT85-08010000W	703-48205-18	899
PAT85-08010000W	703-48205-1A	899
PAT85-08010000W	703-48205-1B	899
PAT85-08010000W	703-48205-20	899
PAT85-08010000W	703-48205-21	899
PAT85-08010100	688-8258A-20	906

REF	OEM	
REC09168-12017		848-849
REC09401-11425	90465-11M59	981
REC13650-52G00	63P-85886-00	878
REC13650-56B00	65L-85886-00	878
REC27-49955		1033
REC308928	308928	925
REC35-80365M	646-24251-01	859
REC35-80365M	646-24251-02	859-862
REC35-822626Q15	69J-13440-01	979-981-855-856-857-862
REC3FV-13440-00	3FV-13440-00, 10, 20, 30	862-851-862
REC40135		859
REC40145	65W-24251-10	859-849-851-861
REC40155	65W242511000	859
REC40165	67F-24251-02	859
REC40165		861
REC41107-ZV5-000		937
REC41107-ZV5-000AL		937
REC48630-96J03	64E-43820-08, 09, 00	898
REC48630-96J03	64E-43821-00	898
REC48630-96J03	64E-43821-00, -05	898
REC48630-96J03	64E-43821-05	898
REC48630-96J03	64E-43821-08, 09, 00	898

REF	OEM	
REC48630-96J03	64E4382100	898
REC48630-96J03	64E4382105	898
REC48630-96J03	6AW-4380R-00	898
REC50M-14355-00	50M-14355-00	875
REC5GH-13440-00	5GH-13440-00, 30, 70	862-951-959-965-977
REC5GH-13440-00	5GH-13440-10	975
REC5GH-13440-00		849-850-851-852-853-854-855-862
REC5GH-13440-60	5GH-13440-20	963-971
REC5GH-13440-60	5GH-13440-50	862-969-973
REC5GH-13440-60	5GH-13440-60	862-955
REC5GH-13440-60		849-850-851-852-853-862
REC60E-81950-00	60E-81950-00	889
REC60V-12411-00	60V-12411-00	914-854-915
REC60V-13907-00	60V-13907-00	865
REC60V-81950-00	60V-81950-00	889
REC60V-81960-05	60V-81960-00, 01, 02, 03, 04, 05	891
REC60X-44315-A0	60X-44315-A0	1089-1130
REC60X-81800-00	60V-81800-00	886
REC60X-81800-00	60X-81800-00	886
REC60X-81800-00	6C9-81800-00	886
REC60X-81800-00	6D0-81800-00	886
REC61A-11325-00	61A-11325-00	933
REC61A-11325-00AL	61A-11325-00	933
REC61A-12414-A0	61A-12414-A0	915-997
REC61A-12414-A0	6J8-12414-A0	1003
REC61A-43880-02	61A-43880-00, 01	897
REC61A-44311-00	61A-44311-00	1129
REC61A-44311-00	61A-44311-01	1079-1083-1085-1089-1125-1127-1130
REC61A-44311-00	6E5-44311-00	923-930-932-933
REC61A-44322-02	61A-44322-02	1079-1083-1085-1089-1125-1127-1129-1130-930-932-933
REC61A-45371-00AL	61A-45371-00	1087
REC61A-45527-00	61A-45527-00	1079-1083-1085-1125-1127-1129
REC61A-45538-00	61A-45538-00	1079-1083-1085-1125-1127-1129
REC61A-81941-00	61A-81941-00	889
REC61A-81941-00	6E5-81941-11	889
REC61A-81941-00		885-886
REC61A-81950-01	61A-81950-00, 01	889
REC61A-81960-04	61A-81960-00, 01, 02, 03, 04	891
REC61A-W0078-A1	61A-W0078-01	929
REC61A-W0078-A1	61A-W0078-A1	1083-1129
REC61A-W0078-A1	61A-W0078-A3	1085
REC61A-W0078-A1		855-856-930-932-933
REC61B-8258A-01	61B-8258A-00-00	907
REC61B-8258A-01	61B-8258A-01	907
REC61N-11181-00	61N-11181-A1	995
REC61N-11181-00	61N-11181-A2	1014
REC61N-11181-00		1018
REC61N-11515-00	61N-11515-00	995
REC61N-11603-00	61N-11603-00	995-1026-1030
REC61N-11604-00	61N-11604-00	995
REC61N-11604-00	61N-11604-00	1026
REC61N-11605-00	61N-11605-00	995-1026
REC61N-11631-00K	61N-11631-00-95	995-1026-1030
REC61N-11635-00K	61N-11635-00	995
REC61N-11635-00K	61N-11635-00	1026
REC61N-11636-00K	61N-11636-00	995-1026
REC61N-14198-00	61N-14198-00	1035
REC61N-14301-04	61N-14301-04	870-877
REC61N-14392-00	62Y-14392-00	874-877
REC61N-24563-10	61N-24563-00	859
REC61N-24563-10	61N-24563-10	859
REC61N-24563-10		849-850-852-853-861
REC61N-26311-00	61N-26311-00	908
REC61N-44146-00	61N-44146-00	1111
REC61N-44322-00	61N-44322-01	929-930-931-1055-1105
REC61N-44323-00	61N-44323-00	923-929-930-931-1055-1105

REF	OEM	
REC61N-45251-01	61N-45251-01	933
REC61N-45251-01AL	61N-45251-01	933-1049-1101-1105
REC61N-45510-00	61N-45510-00	1055-1105-1132-1133
REC61N-45510-10	61N-45510-10	1105-1133-1132-1133
REC61N-45551-00	61N-45551-00	1105-1132-1133
REC61N-45560-10	61N-45560-00	1053
REC61N-45560-10	61N-45560-10	1105
REC61N-45560-10		1132-1133
REC61N-45570-00	61N-45571-00	1105-1132-1133
REC61N-85540-00	61N-85540-00	892
REC61N-85570-01	61N-85570-00	880
REC61N-85570-01	61N-85570-01	880
REC61N-W0078-11	61N-W0078-10	926
REC61N-W0078-11	61N-W0078-11	926-1055-1105
REC61N-W0093-00	61N-W0093-00	873-995-877
REC61T-11193-A0	61T-11193-A1	995-1019
REC61T-45113-A0	61T-45113-A0	1017
REC61T-45113-A0	689-45113-A1	995
REC61U-11601-00		1018
REC61U-11601-00		1031
REC624-14485-00	624-14485-00	988-991-993-997-999-1003-1005-1007-1009
REC624-42542-00	90387-06119	875
REC626-14390-90	626-14390-90	874
REC626-44365-01	626-44365-01	1099-1103
REC626-45316-09	626-45316-09	1049-1050-1099
REC626-45316-09	90381-14020	1101
REC62X-43880-09	62X-43880-00, 01, 09	895
REC62Y-11325-00	62Y-11325-00	937
REC62Y-11325-00AL	62Y-11325-00	849-850-851-852-853-937-965-971-973
REC62Y-43880-02	62Y-43880-01, 02	896
REC62Y-43880-02	69W-43880-00, 01	896
REC62Y-43880-02	CS3-43880-00	896
PAF40-02000008	62Y-45127-00	1032
REC62Y-46241-00	62Y-46241-00	975-1031
REC62Y-W0001-22	62Y-W0001-20, -21, -22	920
REC62Y-W0001-22	62Y-W0001-22	1064
REC633-15713-10	663-15713-00	887
REC634-11633-00	634-11633-00	993-1026-1023
REC63D-11181-A1	63D-11181-A2	1003-1014-1018
REC63D-11193-A0	63D-11193-A0	1003-1019
REC63D-11603-00	63D-11603-00	1003-1027
REC63D-11605-00	63D-11605-00	1003-1027
REC63D-44312-00	63D-44312-00	1059-1063-1067-1071-1073-1111
REC63D-44316-00	63D-44316-00	1059-1063-1067-1071-1111
REC63D-44322-00	63D-44322-00	1059-1063-1067-1071-931
REC63D-44323-00	63D-44323-00	1063-1067-1071-923-930-931
REC63D-44341-00	63D-44341-00	1059-1067-1111
REC63D-45251-01	63D-45251-01	933
REC63D-45251-01AL	63D-45251-01	933
REC63D-45361-02-4D	63D-45361-02-4D	1057-1065-1111
REC63D-45361-02-4D	63D-45361-02-8D	1061-1069
REC63D-45361-02-4D		1133-1134
REC63D-W0078-01	63D-W0078-01	927-1064-1068-852-853-930-931
REC63P-11181-00	63P-11181-00	979-984-985
REC63P-11325-01	63P-11325-01	933
REC63P-11325-01AL	63P-11325-01	933-854-855-857-979
REC63P-11325-11	63P-11325-11	933
REC63P-11325-11AL	63P-11325-11	933-855-857-979
REC63P-11325-21	63P-11325-11	935-854-855
REC63P-11325-21AL	63P-11325-11	935
REC63P-11351-01	63P-11351-00	979
REC63P-11351-01	63P-11351-01	984
REC63P-11351-01		985
REC63P-12414-00	63P-12414-00	915-979-855

REF	OEM	
REC63P-13761-01	63P-13761-00/01	868-868-869
REC63P-13906-00	63P-13906-00	867-868-869
REC63P-13907-03	63P-13907-00	864
REC63P-13907-03	63P-13907-01	864
REC63P-13907-03	63P-13907-02	864
REC63P-13907-03	63P-13907-03	864
REC63P-13915-00	63P-13915-00	862-854-855-856-857
REC63P-14984-00	63P-14984-00	867-855-864
REC63P-43880-22	63P-43880-10	897
REC63P-43880-22	63P-43880-11	897
REC63P-43880-22	63P-43880-12	897
REC63P-43880-22	63P-43880-22	897
REC63P-45551-00	63P-45551-00	1081
REC63P-46241-00	63P-46241-00	979-1031
REC63P-81950-00	63P-81950-00	889
REC63P-81960-02	63P-81960-00, 01, 02	891
REC63P-82380-00	63P-82380-00	878-868-869
REC63V-11181-A1	63V-11181-A1	1014
REC63V-11181-A1	63V-11181-A2	993
REC63V-11181-A1		1018
REC63V-11412-00	63V-11412-00	993-1020
REC63V-11422-00	63V-11422-00	993-1020
REC63V-11432-00	63V-11432-00	993-1020
REC63V-11442-00	63V-11442-00	993-1020
REC63V-11445-00	63V-11445-00	993
REC63V-11515-02	63V-11515-02	993
REC63V-14126-00	63V-14126-00	871
REC63V-14301-00	63V-14301-00	870-877
REC63V-14984-00	63V-14984-00	871
REC63V-14985-00	63V-14985-00	876-877
REC63V-15396-01-CA	63V-15396-01-CA	993
REC63V-24411-00	63V-24411-00	865
REC63V-41111-00-1S	63V-41111-00-1S	993
REC63V-41112-A0	63V-41112-A0	917-993
REC63V-41113-00-1S	63V-41113-00-1S	993
REC63V-41133-A1	63V-41133-A1	1032
REC63V-44301-00	63V-44301-00	1047-1049-1101-922-929-931
REC63V-44322-00	63V-44322-00	929-930-931-1047-1049-1051-1101
REC63V-44323-00	63V-44323-00	1049-1101-923-929-931-921-929-930-931-1049-1051-1101
REC63V-44352-01	63V-44352-01	1101
REC63V-44361-01	63V-44361-01	1101
REC63V-44361-11	63V-44361-11	1101
REC63V-45113-A1	63V-45113-A1	993-1017-1018
REC63V-45300-03-8D	63V-45300-00-4D	1039
REC63V-45300-03-8D	63V-45300-03-4D	1039
REC63V-45300-03-8D	63V-45300-03-8D	1039
REC63V-45300-13-8D	63V-45300-10-4D	1039
REC63V-45300-13-8D	63V-45300-13-4D	1039
REC63V-45300-13-8D	63V-45300-13-8D	1039
REC63V-45315-A0	63V-45315-A0	1049-1101
REC63V-45331-00-5B	63V-45331-00-5B	1049-1101
REC63V-45501-10	63V-45501-11	1049-1131-1132-1101-1132-1131-1132
REC63V-45510-01	63V-45510-01	1131-1132-1101-1132-1131-1132-1132
REC63V-45510-11	63V-45510-11	1131-1132-1132
REC63V-45551-00	63V-45551-00	1049-1101
REC63V-45551-00	63V-45551-00	1051
REC63V-45551-00		1131-1132
REC63V-48501-00	63V-48501-00	903
REC63V-85520-00	63V-85520-00	882
REC63V-85533-00	63V-85533-00	879
REC63V-85540-00-01	63V-85540-00, 01, 02	892
REC63V-85570-00	63V-85570-00	880
REC63V-85570-00	65E-85570-00	880
REC63V-85580-01	63V-85580-01	883
REC63V-W0001-00	63V-W0001-00	993
REC63V-W0001-00	63V-W0001-01	1015
REC63V-W0001-00		1018
REC63V-W0078-01	63V-W0078-00	926
REC63V-W0078-01	63V-W0078-01	1049-1100
REC63V-W0078-01		849-929-931
REC63V-W0093-00	63V-W0093-00	872-993-877
REC63W-13610-00	63W-13610-00	870-875

REF	OEM	
REC646-11633-00	646-11633-00	987
REC646-14623-A1	646-14623-A1	987-1033-1018
REC646-44322-00	646-44322-00	1093
REC646-44322-00	646-44323-00	1093
REC646-44323-00	646-44323-00	923-924-931
REC646-44352-01	646-44352-01	921-1093-931
REC646-44365-00	646-44365-00	1093
REC646-44366-01	646-44366-01	1093
REC646-45551-00	646-45551-00	1093-1131
REC646-45560-00	646-45560-00	1093-1131
REC647-11610-00	647-11610-00	991-1026-1030
REC647-11610-10	647-11610-10	991
REC647-14323-00	647-14323-00	875
REC647-14385-00	647-14385-00	876
REC647-14386-10	647-14386-10	875
REC647-44366-00	647-44366-00	1049-1096-1097-1101-929-931
REC647-45316-09	647-45316-09	1097
REC647-45551-00	647-45551-00	1097-1131
REC647-45560-00	647-45560-00	1097-1131
REC647-45570-00	647-45570-01	1097-1131
REC647-45616-02	647-45616-02	1095
REC648-11633-00	648-11633-00	1003-1027-1023-1024-1023-1024
REC648-11651-00		1023-1024
REC648-13621-A0	648-13621-A1	1035
REC648-13645-A0	648-13645-A0	1034
REC648-14198-A0	648-14198-A0	1035
REC648-14384-01-00	648-14384-01	871
REC648-14385-00	648-14385-00	876
REC648-24411-00	648-24411-00	866
REC648-24434-01	648-24434-01	866
REC648-24435-02	648-24435-02	866
REC648-44146-00	648-44146-00	912
REC648-45633-00	648-45633-00	1049-1053-1099-1101-1103-1105-1107
REC648-45633-11		1051
REC648-45633-00		1131-1132-1133
REC648-45635-00	648-45635-00	1053-1103-1105
REC64D-11603-01	64D-11603-01	1011
REC64D-11603-01	64D-11603-02	1013-1029-1030
REC64D-11603-01		1031
REC64D-11604-01	64D-11603-04	1029
REC64D-11604-01	64D-11604-01	1011-1013
REC64D-11604-01	64D-11604-02	1013
REC64D-11605-01	64D-11603-05	1029
REC64D-11605-01	64D-11605-01	1011
REC64D-11605-01	64D-11605-02	1013
REC64D-11631-00K	64D-11631-02-90	1013-1030-1031
REC64D-11642-00K	64D-11642-02-90	1013-1030-1031
REC64D-14384-1	64D-14384-01	872
REC64D-14394-00	64D-14394-00	875
REC64D-82570-31-00	64D-82570-31-00	905
REC64D-W0093-00	64D-W0093-00	874-1013
REC64E-43822-00	64E-43822-00	898
REC64E-4384J-00	64E-4384J-00	898
REC64J-24560-10	64J-24560-00	860
REC64J-24560-10	64J-24560-10	860
REC64J-W0001-20	64J-W0001-20	920
REC650-11370-00	650-11370-00	997
REC650-11370-00	650-11370-01	991-1001-1003-1005-1007-1009
REC650-11651-04	650-11651-00	993-1023
REC650-14485-03	650-14485-03	993
REC650-24431-A0	650-24431-A0	866
REC650-44147-00	650-44147-00	912-1113-1117
REC650-45635-00	650-45635-00	1049-1051-1099-1101-915-995
REC655-12414-A1	655-12414-A1	1025
REC656-11515-00	656-11515-00	1025
REC65L-13761-00	65L-13761-00	868
REC65L-13915-00	65L-13915-00	861
REC65L-24563-00	65L-24563-00	860-855-856-861
REC65N-W0078-A1	65N-W0078-A1	928-932
REC65W-11351-10	65W-11351-00	959
REC65W-11351-10	65W-11351-10	984
REC65W-11351-10		985
REC65W-14384-00	65W-14384-00	871
REC65W-45251-00		937

REF	OEM	
REC65W-45251-00AL		937
REC65W-46241-00	65W-46241-00	961-967-1031
REC65W-48501-01	65W-48501-00	904
REC65W-48501-01	65W-48501-01	904
REC65W-61350-00	65W-61350-00	904
REC65W-81800-03	65W-81800-00, 01, 02, 03	884
REC65W-82575-01	65W-82575-01	894
REC65W-W0001-00	65W-W0001-00	985-985
REC662-44352-01	662-44352-01	921-1097
REC663-11193-00	663-11193-A0	1005-1019
REC663-11561-00	663-11561-00	1005
REC663-11633-00	663-11633-00	1005-1009-1028-1024
REC663-11634-00	663-11634-00	999-1027-1001-1027
REC663-12414-00	663-12414-A0	916-1005
REC663-12416-00	663-12416-00	1001-1005
REC663-13621-00	663-13621-A0	1035
REC663-13622-00	663-13622-00	1036
REC663-14198-00	663-14198-A0	1035
REC663-14483-A0	663-14483-A0	1035
REC663-24411-00	663-24411-00	866
REC663-41114-00	663-41114-A0	918-1005
REC663-42138-00	663-42138-00	909
REC663-43118-01-4D	663-43118-01-4D	912
REC663-44144-01	663-44144-01	1119-1121
REC663-44151-00	663-44151-00	1119-1121
REC663-44311-02	663-44311-02	1109-1119
REC663-44311-02	663-44311-02-00	922
REC663-44311-02	663-44341-00	1119
REC663-44311-02	618-44311-00	1107
REC663-44311-02		931
REC663-44315-A0	663-44315-A0	931-1107-1109-1119
REC663-44316-A0	663-44316-A0	1107-1109-1119
REC663-44322-00	663-44322-00	930-931-1107-1109-1119
REC663-44323-00	663-44323-00	924-931-1107-1109-1119
REC663-44324-00	663-44324-A0	1107-1109-1119
REC663-44366-00	663-44366-00	930-931-932-1059-1063-1067-1071-1073-1077-1085-1107-1109-1111-1113-1117-1119-1121-1123-1129
REC663-44551-02-8D	663-44551-02-8D	913
REC663-45123-00	663-45123-00	1032
REC663-45331-00-9A	663-45331-00-9A	1119-1134
REC663-45375-00	663-45375-00	1117
REC663-45376-00	663-45376-00	1063-1079-1087-1117
REC663-45376-00	663-45376-00-9A	1059-1067-1071-1073-1077-1083
REC663-45510-01	663-45510-01	1119-1134
REC663-45552-00	663-45552-00	1109-1115-1119
REC663-45576-00	663-45576-00	1115
REC663-45631-00	663-45631-01	1109-1113-1115-1119-1133-1134
REC663-45633-00	663-45633-00	1115-1119-1133-1134
REC663-45634-00	663-45634-00	1061-1065-1069-1109-1113-1115-1119
REC663-45987-00	663-45987-00	1115
REC663-45987-00	663-45987-02	1057-1061-1065-1069-1109-1111-1119-1144
REC663-48344-00	663-48344-00	902
REC663-85518-00	633-85518-00	911
REC663-85540-15	663-85540-11, 15	893
REC663-W0078-01	663-W0078-00	1119
REC663-W0078-01	663-W0078-01	928-1119
REC663-W0078-01		931
REC664-41114-A0	664-41114-A0	917
REC664-44338-00	63V-44338-00	1101
REC664-44338-00	664-44338-00	1047-1049-1051-1103
REC664-44338-00		929-930-931
REC664-45371-01	664-45371-01	937
REC664-45371-01AL	664-45371-01	850-937-1103-1107-1109-1111

REF	OEM	
REC664-45384-00	664-45384-00	1103-1107
REC664-45631-00	664-45631-02	1105-1132-1133
REC664-45631-01	664-45631-01	1103
REC664-45987-00	664-45987-00	1103
REC67H-13907-00	65L-13907-00	865
REC67H-13907-00	66K-13907-00	865
REC66K-13915-00	66K-13915-00	861
REC66M-11325-00		937
REC66M-11325-00AL		849
REC66M-11325-00AL		937
REC66M-45371-00	66M-45371-00	933
REC66M-45371-00AL	66M-45371-00	849-933-1049
REC66M-46241-00	66M-46241-00	953-1031
REC66M-48501-01	66M-48501-01	904
REC66M-W0001-20	66M-W0001-20	919-1049
REC66M-W0093-01	66M-W0093-01	872
REC66N-11603-00	66N-11603-00	951-986
REC66T-11181-00	66T-11181-00	1015
REC66T-11181-00	66T-11181-A2	999
REC66T-11181-00		1018
REC66T-11193-A0	66T-11193-A0	999-1019
REC66T-11412-00	66T-11412-00	999-1020
REC66T-11432-00	66T-11432-00	999-1020
REC66T-11442-00	66T-11442-00	999-1020
REC66T-11603-00	66T-11603-00	999-1027-1030
REC66T-11604-00	66T-11604-00	999-1027
REC66T-11605-00	66T-11605-00	999-1027
REC66T-11631-01K	66T-11631-01-93	999-1027-1030
REC66T-11635-01K	66T-11635-01	999-1027
REC66T-11636-01K	66T-11636-01	999-1027
REC66T-11681-00	66T-11681-00	999-1023-1024
REC66T-14301-60	66T-14301-60	870-877
REC66T-14384-01	66T-14384-01	871
REC66T-14536-01	66T-14536-01	871
REC66T-14992-00	66T-14992-00	875
REC66T-15713-00	66T-15713-00	887
REC66T-15713-00	65F-15713-00, 01	887
REC66T-26301-00	66T-26301-00	908
REC66T-41114-A0	66T-41114-A0	999
REC66T-41114-A0	66T-41114-A0	918
REC66T-41133-A1	66T-41133-A0	1032
REC66T-44323-00	66T-44323-00	924-930-1059-1111
REC66T-44514-00-4D	66T-44514-00-4D	913
REC66T-45113-A0	66T-45113-A0	1017
REC66T-45113-A0	66T-45113-A00	999
REC66T-45113-A0		1018
REC66T-45114-A0	66T-45114-A0	1034
REC66T-45501-01	66T-45501-01	1111-1133
REC66T-45501-10	66T-45501-11	1111-1133-1134
REC66T-45551-00	66T-45551-00	1061
REC66T-45551-00	66T-45551-00	1057-1111
REC66T-45551-00		1133-1134
REC66T-45560-00	66T-45560-01	1111-1133-1134
REC66T-45571-00	66T-45571-00	1061-1057-1111-1133-1134
REC66T-45611-00	66T-45611-00	1057-1111-1133-1134
REC66T-45631-00	66T-45631-00	1057-1111-1133-1134
REC66T-45635-00	66T-45635-00	1057-1111
REC66T-45997-00	66T-45997-00	1061-1065-1069
REC66T-45997-00	66T-45997-00	1057-1111-1115
REC66T-45997-00		1144
REC66T-48501-02	66T-48501-02	903
REC66T-82105-J2	66T-82105-00	887
REC66T-82105-J2	66T-82105-J2	887
REC66T-82575-01	66T-82575-01	894
REC66T-85520-00	66T-85520-00	882
REC66T-85533-00	66T-85533-00	879
REC66T-85540-00-01	66T-85540-01	893
REC66T-85570-00	66T-85570-00	881
REC66T-85580-00	66T-85580-00	883
REC66T-W0001-01	66T-W0001-01	999-1016-1018
REC66T-W0001-20	66T-W0001-20	920-1111
REC66T-W0078-00	66T-W0078-00	1056-1111
REC66T-W0078-00	66T-W0078-01	928
REC66T-W0078-00		850-851-930
REC66T-W0093-01	66T-W0093-01	873-999-877
REC670-44514-00	670-44514-00	913
REC670-44555-00-94	62Y-44555-00	913

REF	OEM	
REC670-45997-00	670-45997-02	1109-1119
REC676-11181-01	676-11181-A2	1015-1018
REC676-11325-00	676-11325-00	935
REC676-11325-00AL	676-11325-00	935-991-999-1001
REC676-12414-A0	676-12414-A0	999
REC676-12414-A0	676-12414-A1	915
REC676-14186-00	676-14186-00	875
REC676-14966-00	679-14966-00	876
REC676-14984-00-00	676-14984-00	872
REC676-14985-01	676-14985-01	876
REC676-15471-00	676-15471-00	887
REC676-41133-A0	676-41133-A0	1032
REC676-43160-02	676-43160-00	910
REC676-43160-02	676-43160-01	910
REC676-43160-02	676-43160-02	910
REC676-44311-00	676-44311-00	922-931-1113-1117
REC676-44315-00	676-44315-A0	1117
REC676-44315-00	676-44315-A1	1113
REC676-44315-00		931
REC676-44316-A1	676-44316-A1	1113
REC676-44322-00	676-44322-00	1117-931
REC676-44323-00-40	676-44323-00	923-1117
REC676-44323-00-40	676-44323-40	1113
REC676-44323-00-40		931
REC676-44324-A0	676-44324-A0	1117
REC676-44324-A0	676-44324-A1	1113
REC676-44341-00	676-44341-94	1113
REC676-44361-00	676-44361-00	1117
REC676-44361-10	676-44361-10	1117
REC676-44518-00	676-44518-00	913
REC676-45114-A1	676-45114-A1	1034
REC676-45127-00	676-45127-00	1032
REC676-45251-00	676-45251-00	937
REC676-45251-00AL	676-45251-00	937-999-1001
REC676-45314-00	676-45314-00	1113
REC676-45361-00	676-45361-01-94	1113-1134
REC676-45501-10	676-45501-10	1113-1134-1133
REC676-45587-00	676-45587-00-70	1113
REC676-45587-00-75	676-45587-00-75	1113
REC676-45587-00-80	676-45587-00-80	1113
REC676-45635-00	676-45635-00	1109-1113-1115
REC677-11181-A0	677-11181-A1	991-1014-1018
REC677-11631-00K	677-11631-00-97	991-1026-1030
REC677-11635-00	6771163500	1029
REC677-11635-00K	677-11635-00	991-1026
REC677-11636-00	6771163600	1029
REC677-11636-00K	677-11636-00	991-1026
REC677-11651-00		1023
REC677-13621-00	677-13621-A1	1035
REC677-14198-A1	677-14198-A1	1034
REC677-14227-00	677-14227-01	871
REC677-14343-68	677-14343-68	874
REC677-14384-01	677-14384-01	871
REC677-15741-01	677-15741-01	887
REC677-24411-02	677-24411-02	866
REC677-24434-02	677-24434-02	1034
REC677-24435-01	677-24435-01	866
REC677-24471-01	677-24471-01	865
REC677-26301-02	677-26301-02	908
REC677-41112-A0	677-41112-A1	991
REC677-41112-A0	677-41114-A0	917
REC677-41112-A0	677-41114-A1	991
REC677-41112-A0		1133
REC677-45113-A0	677-45113-A0	991-1017-1018
REC677-W0093-00	677-W0093-00	872
REC679-14923-00	679-14923-00	875
REC679-44150-00	679-44150-00	1117
REC679-44150-10	679-44150-10	1117
REC679-44152-00	679-44152-00	1117
REC679-44316-A0	679-44316-A0	1117
REC679-44341-00	679-44341-00-94	1117
REC679-44514-00-94	679-44514-00-94	913
REC679-45251-00	679-45251-00	935
REC679-45251-00AL	679-45251-00	935
REC679-45315-A1	679-45315-A1	1115
REC679-45321-02	679-45321-02	1115
REC679-45331-00	679-45331-00-94	1115
REC679-45371-00	679-45371-00	935
REC679-45371-00AL	679-45371-00	935-1115-1119

REF	OEM	
REC679-45536-00	679-45536-00	1117
REC679-45560-00	679-45560-00	1115-1133
REC679-45571-00	679-45571-00	1115
REC679-45611-00	679-45611-01	1109-1115-1133-1134
REC679-W0078-A1	679-W0078-00	927-931
REC67C-11181-01	67C-11181-01	965-983-985
REC67C-11351-00	67C-11351-01	965-975-984-985
REC67C-11603-00	67C-11603-00	961-963-967-969-971-973-986
REC67C-41133-00	67C-41133-00	1032
REC67C-45251-00	67C-45251-00	937
REC67C-45251-00AL	67C-45251-00	850-851-852-853-937-1057-1061-1065-1069-1111
REC67C-45371-00	67C-45371-00	937
REC67C-45371-00AL	67C-45371-00	850-851-852-853-937-1057-1061-1065-1069
REC67C-81800-02	67C-81800-00, 01, 02	884
REC67D-W0093-00	67D-W0093-00	872
REC67F-11181-03	67F-11181-02	977
REC67F-11181-03	67F-11181-03	983
REC67F-11181-03		985
REC67F-11325-00	67F-11325-00	937
REC67F-11325-00AL	67F-11325-00	937-981
REC67F-11325-01	67F-11325-01	937
REC67F-11325-01AL	67F-11325-01	854-855-856-857-937-979
REC67F-11328-00	67F-11328-00	977-979-982
REC67F-12411-01	67F-12411-00	914
REC67F-12411-01	67F-12411-01	914-977-979-981
REC67F-12411-01		853-854-855-856-857-915
REC67F-14371-01	67F-14371-01	876
REC67F-41114-A2	6D8-41114-A0	977
REC67F-43880-00	67F-43880-00	896
REC67F-44311-01	67F-44311-00	1077-922-930
REC67F-44322-00	67F-44322-00	1077-930
REC67F-44323-00	67F-44323-00	924-1077-930
REC67F-44352-00	67F-44352-00	921-930-1077
REC67F-45371-00	67F-45371-00	854-937
REC67F-45371-00AL	67F-45371-00	852-853-937-1073-1075-1121-1123
REC67F-45560-00	67F-45560-00	1075-1134
REC67F-45570-00		1135
REC67F-45576-00	67F-45576-00	1073-1075
REC67F-45611-01	67F-45611-01	1073-1075-1135
REC67F-45997-00	67F-45997-00	1073-1075-1121-1144
REC67F-46241-00	67F-46241-00	977-1031
REC67F-81800-04	67F-81800-01, 02, 03, 04	885
REC67F-81960-12	67F-81960-00	891
REC67F-85570-00	67F-85570-00	881
REC67F-W0078-00	67F-W0078-00	928-930-1074-853-854
REC67F-W0093-00	67F-W0093-00	874
REC67H-11411-00		1020
REC67H-13907-00	67H-13907-00	865
REC67H-43880-10	67H-43880-00	897
REC67H-43880-10	68W-43880-03	897
REC67H-43880-10	6AE-43880-00, 01, 03, 04	897
REC682-11325-00	682-11325-00	935
REC682-11325-00AL	682-11325-00	935-993-995
REC682-11351-A0	682-11351-A0	1017
REC682-11412-00		1020
REC682-11422-00		1020
REC682-11432-00		1020
REC682-11442-00		1020
REC682-11610-01	682-11610-00	1026
REC682-11610-01	682-11610-01	993
REC682-11610-01		1030
REC682-11610-11	682-11610-11	993-1026
REC682-11610-21	682-11610-21	993-1026
REC682-11681-00	682-11681-00	993-1023
REC682-12413-00-1S	682-12413-00-1S	916-993
REC682-12413-00-1S	682-12413-00-9M	916
REC682-12414-A1	682-12414-A1	915-916-993

REF	OEM	
REC682-13621-00	682-13621-A0	1034-1035
REC682-41112-00	682-41112-A1	917
REC682-41112-00	682-41114-A1	917
REC682-41133-A0	682-41133-A0	1032
REC682-41237-00	682-42137-00	911
REC682-41237-50	682-41237-50	911
REC682-44147-00	682-44147-00	1099-1107
REC682-44176-00	682-44176-00	1099
REC682-44312-00	682-44312-00	929-931-932-1099
REC682-44322-00	682-44322-00	929-931-932-1099929-932-932
REC682-44323-40	682-44323-00	929-931-932-1099
REC682-44328-00	682-44328-00	1099
REC682-44352-01	682-44352-00	1099
REC682-44352-01	682-44352-03	921
REC682-44352-01		929-931-932
REC682-44361-01	682-44361-01	1099
REC682-44361-10	682-44361-10	1099
REC682-44365-00	682-44365-00	929-931-932-1099
REC682-44514-01-94	682-44514-01-94	913
REC682-45113-A0	682-45113-02	1033-1018
REC682-45376-01	682-45376-01	1099
REC682-45631-00	682-45631-00	1049-1051-1099-1101-1131-1132
REC682-W0078-A1	682-W0078-A1	926-929-931-932-1098
REC683-44362-01	683-44361-01	1099
REC683-44365-01	683-44365-01	1099
REC683-44373-00	683-44373-00	1099
REC683-45315-A0	683-45315-00	1099
REC683-45361-01-4D	683-45361-00-EJ	1099
REC683-45361-01-4D	683-45361-02-4D	1049-1101
REC683-45361-01-4D	683-45361-02-8D	1051
REC683-45361-02-4D		1131-1132
REC683-45611-00	683-45611-00	1049-1051-1099-1101-1131-1132
REC688-11111-02-1S	688-11111-02-1S	1009
REC688-11181-A1	688-11181-A1	1009
REC688-11181-A1	688-11181-A2	1015
REC688-11181-A1		1018
REC688-11193-A1	688-11193-A1	1009-1019
REC688-11325-00	688-11325-00	935
REC688-11325-00AL	688-11325-00	935-1003-1009
REC688-11370-00	688-11370-01	1003-1007-1009
REC688-11411-00	688-11411-01	1009-1020
REC688-11603-A0	688-11603-A0	1005-1009-1028-1030-1031
REC688-11605-A0	688-11605-A0	1005-1009-1028
REC688-11610-02	688-11610-02	1028-1030-1031
REC688-11631-02K	688-11631-02-95	1028-1030
REC688-11631-03K	688-11631-03-94	1005-1009-1028
REC688-11631-81K	688-11631-81-96	1028-1030-1031
REC688-11634-00	688-11634-00	995-1005-1009-1026-1028
REC688-11634-00	688-11634-10	1007
REC688-11635-03K	688-11635-03	1005-1028
REC688-11636-03K	688-11635-03	1005-1028
REC688-11650-03	688-11650-03	1005-1009
REC688-11651-00		1024
REC688-12413-00-1S	688-12413-00-1S	916-1009
REC688-12414-A1	688-12414-A1	916-1009-1011-1013
REC688-12416-00	688-12416-00	916-1009
REC688-13610-00	688-13610-00	875
REC688-13621-A1	688-13621-A1	1036
REC688-14198-A1	688-14198-A2	1036
REC688-14416-01	688-14416-01	1035
REC688-14483-A0	688-14483-A0	1035
REC688-14548-00	688-14548-00	875
REC688-14947-00	688-14947-00	874
REC688-41112-A0	688-41112-A0	918-1009
REC688-41114-A0	688-41114-A0	919-1009
REC688-41133-00	688-41133-00	1033
REC688-41134-00	688-41134-A0	1032
REC688-41211-01	688-41211-01	911
REC688-41211-01	688-41211-01	911
REC688-41217-00	688-41217-00	877
REC688-43160-01	688-43160-01	910

REF	OEM	
REC688-43880-11	688-43880-11	896
REC688-43880-11	6E5-43880-00, 01, 02	896
REC688-44120-12	688-44120-11	912
REC688-44120-12	688-44120-12	912
REC688-44120-22	688-44120-22	912
REC688-44311-01	688-44311-01	922
REC688-44311-01	688-44311-01	1121
REC688-44311-01		931-932
REC688-44311-01	688-44311-01-00	1123
REC688-44315-00	688-44315-A0	1077-1121
REC688-44315-00		930-931-932
REC688-44315-00	688-44315-A0-00	1123
REC688-44316-00	688-44316-00	1077
REC688-44316-00	688-44316-A0	1121
REC688-44316-00	688-44316-A0-00	1123
REC688-44322-00	688-44322-00	1121
REC688-44322-00		931-932
REC688-44322-00	688-44322-00-00	1123
REC688-44323-00	688-44323-00-00	924
REC688-44323-00	688-44323-00-00	1123
REC688-44323-00	688-44323-40	1121
REC688-44323-00		931-932
REC688-44324-00	688-44324-A0	1077-1121
REC688-44324-00	688-44324-A0-00	1123
REC688-44341-01	688-44341-01-94	1121
REC688-44341-01	6D8-44341-01	1077
REC688-44341-01	688-44341-01-94	1123
REC688-44352-03	688-44352-03	921-931-932-1121
REC688-44352-03	688-44352-03-00	1123
REC688-44361-10	688-44361-10	1121
REC688-44514-00	688-44514-00	913
REC688-44555-00	688-44555-00	913
REC688-45113-A0	688-45113-A0	1009-1017-1018
REC688-45114-A1	688-45114-A1	1034
REC688-45123-00	688-45123-00	1033
REC688-45214-02	688-45214-02	1079-1115
REC688-45215-02	688-45215-02	1079-1115
REC688-45251-01		937
REC688-45251-01AL		851-852-853-937
REC688-45331-00-94	688-45331-00-94	1121-1123-1132-1134-1135
REC688-45341-00	688-45341-00	1053-1109-1125
REC688-45341-00	688-45341-00-00	1123
REC688-45341-00		1057-1061-1065-1069-1073-1075-1079-1081-1085-1087-1089-1091-1105-1111-1113-1119-1121-1127
REC688-45375-00	63D-45375-00	1073-1077-1079
REC688-45375-00	688-45375-00	1083-1121
REC688-45383-01	688-45383-02	1073-1075-1079-1121-1125
REC688-45383-01	688-45383-02-00	1123
REC688-45384-00	688-45384-00	1121-1125
REC688-45384-00	688-45384-02	1073-1075-1079
REC688-45384-00	688-45384-00-00	1123
REC688-45536-01	688-45536-01	1073-1077
REC688-45551-00	688-45551-01	1121-1134-1135
REC688-45551-00	688-45551-01-00	1123
REC688-45560-00	688-45560-00	1121-1134-1135
REC688-45560-00	688-45560-00-00	1123
REC688-45570-00	688-45571-01	1121
REC688-45571-00-00		1134-1135
REC688-45611-00	688-45611-00	1121-1134-1135
REC688-45631-00	688-45631-01	1121-1134-1135
REC688-45633-00	688-45633-00	1073-1075-1121
REC688-45633-00	688-45633-00-00	1123
REC688-45633-00		1134-1135
REC688-45634-00	688-45634-00	1121
REC688-45635-00	688-45635-00	1119-1121
REC688-45987-00	688-45987-01	1073-1075-1121
REC688-45987-00	688-45987-01-00	1123-1144
REC688-45997-00	688-45997-00	1129
REC688-45997-00		1079-1081-1085-1087-1089-1125-1127
REC688-45997-00	688-45997-01-00	1123-1144

REF	OEM	
REC688-81800-12	688-81800-10, 11, 12	885
REC688-82560-10	688-82560-10	879
REC688-82575-01	688-82575-01	894
REC688-82586-11	688-82586-11	907
REC688-82586-11	688-8258A-10-07	907
REC688-82586-32	688-82586-32	907
REC688-82586-32	688-8258A-30-07	907
REC688-82586-51	688-82586-51	907
REC688-82586-51	688-8258A-50-07	907
REC688-8258A	688-8258A-10	906
REC688-8258A-30	688-8258A-30	906
REC688-8258A-50-00	688-8258A-50-00	907
REC688-8258A-60	688-8258A-60	907
REC688-8258A-60	6X3-8258A-10-00	907
REC688-8258A-60		907
REC688-82590-00	688-82590-00	907
REC688-85510-01	688-85510-00, 01	894
REC688-85540-00	688-85540-00	893
REC688-85540-16	688-85540-16	893
REC688-W0001-20	688-W0001-20	920
REC688-W0001-22	688-W0001-22	920-1120-1123
REC688-W0001-A0	688-W0001-A0	1016-1018
REC689-11181-00	689-11181-A2	1014-1018
REC689-11325-00	689-11325-00	935
REC689-11325-00AL	689-11325-00	935-995
REC689-11515-00	689-11515-00	1025
REC689-11610-00	689-11610-01	1027-1030
REC689-11631-00K	689-11631-00-95	1027-1030
REC689-11633-00	689-11633-00	995-1026-1027-1023
REC689-11651-00	689-11651-00	995-1023-1024
REC689-11681-00	689-11681-01	995-1023-1024
REC689-15396-01-CA	689-15396-01-5B	995
REC689-15755-00	689-15755-00	912
REC689-41112-A0	689-41112-A0	918
REC689-41114-A0	689-41114-A0	918
REC689-44311-00	689-44311-03	922-931-1103
REC689-44315-A0	689-44315-A0	1103
REC689-44316-A0	689-44316-A0	1103
REC689-44323-00	689-44323-03	1103-931
REC689-44324-A0	689-44324-A0	931-1103
REC689-44352-02	689-44352-02	921-931-1103
REC689-44366-00	689-44366-00	931-1103-1105
REC689-45501-10	689-45501-10	1103-1132-1133
REC689-45551-00	689-45551-00	1103-1132-1133
REC689-45560-00	689-45560-00	1103-1132-1133
REC689-45571-00-00	689-45570-00	1103-1132-1133
REC689-45611-00	689-45611-00	1103-1132-1133
REC689-45997-00	689-45997-00	1053-1103-1105-1107-1144
REC689-48501-50-00	689-48501-50-00	903
REC689-61350-02	689-61350-02	904
REC689-81311-40	68M-85570-00	880
REC689-81800-13	689-81800-10, 11, 12, 13	884
REC689-W0078-A6	689-W0078-04	926-931
REC689-W0078-A6	689-W0078-A6	926-931-1103
REC689-W0093-02	689-W0093-02	872
REC689-W4432-01	689-W4432-02	931-1103
REC68D-E1603-00	68D-E1603-00	943-986
REC68F-11181-00	68F-11181-00	1015-1018
REC68F-13440-00	68F-13440-00	862
REC68F-13907-01	68F-13907-01	864
REC68F-13915-00	68F-13915-00	861
REC68F-24563-00	68F-24563-00	860-861
REC68F-24563-10	68F-24563-10	860-861
REC68F-8195A-00	68F-8195A-00	889
REC68F-83688-00	68F-83688-00	868-878
REC68T-11325-00	68T-11325-00	937
REC68T-11325-00AL	68T-11325-00	855-856-857-937-979
REC68T-24251-00	68T-24251-00	859
REC68T-24251-00	68T-24251-01	859
REC68T-24251-00	6EE-F4251-00	859
REC68T-24251-00		848-849-861
REC68T-24410-00-00	68T-24410-00	863
REC68T-24410-00-00	68T-24410-01	863
REC68T-44323-00	68T-44323-00	923-929-1047-1051
REC68T-44352-00	68T-44352-00	921-929-1047

REF	OEM	
REC68T-44366-00	68T-44366-00	929-1047
REC68T-45251-00AL	68T-45251-00	848-849-937-1047
REC68T-45251-00	68T-45251-00	937
REC68T-45551-00	6N0-G5551-A0	1047
REC68T-46241-00	60R-G6241-00	948
REC68T-46241-00	68T-46241-00	1031
REC68T-85540-00	68T-85540-00	892
REC68T-W0078-00	68T-W0078-00	926-1047
REC68T-W0078-00	68T-W0078-01	926
REC68T-W0078-00		848-849-929
REC68V-11325-01	68V-11325-01	856-937
REC68V-11325-01AL	68V-11325-01	853-937-977
REC68V-11325-02	68V-11325-02	935
REC68V-11325-02AL	68V-11325-02	935
REC68V-11351-00	68V-11351-00	977-984-985
REC68V-13907-00	68V-13907-00, 01, 02, 03, 04, 05, 06	865
REC68V-13915-00	68V-13915-00	856-861
REC68V-14984-00	68V-14984-00	856-864-865-867
REC68V-15312-00	68V-15312-00	1034
REC68V-24410-00	68V-24410-00	863
REC68V-24563-00	68V-24563-00	859-852-861
REC68V-44323-00	6EK-44323-00	924-1079-930
REC68V-45501-10	68V-45501-10	1079
REC68V-81800-03	68V-81800-00, 01, 02	885
REC68V-8194A-00	68N-81940-00	889
REC68V-8194A-00	68V-8194A-00	889
REC68V-81950-00	68V-81950-00	889
REC68V-81960-10	68V-81960-10	891
REC68V-81960-10	68V8196010	891
REC68V-82380-00	68V-82380-00	868-869-878
REC68V-85885-00	68V-85885-00	868-878
REC68V-8A360-00	68V-13761-00	868
REC68V-8A360-00	68V-8A360-00	868
REC68V-8A360-00		868
REC68V-W0078-00	68V-W0078-00	854-855-928-930-1078
REC692-14590-01	692-14590-00	874
REC692-14590-01	692-14590-01	874
REC692-14923-00	692-14923-00	875
REC692-24410-00	692-24410-00	863
REC692-24410-00	6A0-24410-00	863
REC692-24410-00	6A0-24410-03	863
REC692-24410-00	6A0-24410-04	863
REC692-24410-00	6A0-24410-05	863
REC692-24411-00	692-24411-00	865
REC692-26301-03	692-26301-00, 01, 02, 03	908
REC692-41256-00	692-41256-00	877
REC692-44120-22	692-44120-21	912
REC692-44120-22	692-44120-22	912
REC692-45300-16-8D	692-45300-12-4D	1039
REC692-45300-16-8D	692-45300-13-4D	1039
REC692-45300-16-8D	692-45300-14-4D	1039-1121
REC692-45300-16-8D	692-45300-16-8D	1039
REC692-W0078-02	692-W0078-02	928-931-932-1120-1123
REC695-11181-00	695-11181-A1	1014-1018
REC695-85540-11	695-85540-11, 12	892
REC696-14590-01	696-14590-01	874
REC696-45113-00	696-45113-00	1005
REC696-45113-00	696-45113-A0	1017
REC696-45113-00		1018
REC697-11181-A1	697-11181-A2	1005-1015-1018
REC697-45114-00	697-45114-A0	1018-1034
REC697-45384-00	697-45384-00	1109-1115-1119
REC697-45551-00	697-45551-00	1119-1134
REC697-45560-00	697-45560-00	1119-1134
REC697-45570-00	697-45571-00	1119
REC697-45571-00-00		1134
REC697-45611-00	697-45611-00	1119-1132-1134
REC697-85570-00	697-85570-00	881
REC697-85570-10	697-85570-11	881
REC697-W0001-02	697-W0001-A0	1016-1018
REC69D-W0001-20	69D-W0001-20	920
REC68T-W0078-00	69G-W0078-00	926
REC68T-W0078-00	69G-W0078-01	926
REC69J-12119-00	69J-12119-00	979
REC69J-13440-04	69J-13440-00, 01, 02, 03, 04	862

REF	OEM	
REC69J-13761-00	69J-13761-00	868-869
REC69J-13906-00	69J-13906-00	867-869
REC69J-13907-03	69J-13907-00	864
REC69J-13907-03	69J-13907-01	864
REC69J-13907-03	69J-13907-02	864
REC69J-13907-03	69J-13907-03	864
REC69J-13907-03	69J-13907-04	864
REC69J-24410-02	69J-24410-00	864
REC69J-24410-02	69J-24410-01	864
REC69J-24410-02	69J-24410-02	864
REC69J-24501-10		855-856
REC69J-24502-00	69J-24502-00	860
REC69J-41138-00	69J-41138-00	1033
REC69J-43880-01	60V-43880-00	897
REC69J-43880-01	69J-43880-00, 01	897
REC69J-45611-00	69J-45611-00	1085-1089-1136
REC69J-46241-00	69J-46241-00	1031
REC69J-81800-01	69J-81800-00, 01	886
REC69J-81960-13	64J-81960-00	890
REC69J-81960-13	64J-81960-10	890
REC69J-81960-13	69J-81960-10, 11, 12, 13	891
REC69J-85885-00	69J-85885-00	868-869-878
REC69K-45611-00	69K-45611-00	1085-1089
REC69L-11631-00K		1031
REC69L-11642-00		1031
REC69L-11646-00	69L-11646-00	1029
REC69L-45371-00	69L-45371-00	935
REC69L-45371-00AL	69L-45371-00	935
REC69M-E1603-01	69M-E1 603-01	941-986
REC69P-85541-09	69P-85541-09	882
REC69W-81800-00	61A-81800-00, 01	886
REC69W-81800-00	69L-81800-00	886
REC69W-81800-00	69W-81800-00	886
REC69W-82575-00	69W-82575-00	894
REC6A0-14325-00	6A0-14325-00	875
REC692-24410-00	6A0-24410-00	863
REC692-24410-00	6A0-24410-01	863
REC692-24410-00	6A0-24410-02	863
REC692-24410-00	6A0-24410-03	863
REC692-24410-00	6A0-24410-04	863
REC6A0-82550-01	6A0-82550-01	894
REC6A1-14301-A0	6A1-14301-03	870-877
REC6A1-14613-A0	6A1-14613-A0	987
REC6A1-14613-A0	6A1-14613-A0, 01, 01	1033
REC6A1-44361-00	6A1-44361-00	1093
REC6A1-85540-01	6A1-85540-00, 01	892
REC6A1-85570-00	6A1-85570-00	880
REC6A1-W0078-01	6A1-W0078-01	925-931-1093
REC6AG-11181-00	6AG-11181-00	983
REC6AG-11181-00	6AG-11181-10	955
REC6AG-11181-00		985
REC6AH-11351-00	6AH-11351-10	955-984-985
REC6AH-12411-00	69M-12411-00	914
REC6AH-12411-00	69M-12411-01	914-941-943-949
REC6AH-12411-00	6AH-12411-00	914-955
REC6AH-12411-00		849-915
REC6AH-45251-00	6AH-45251-00	935
REC6AH-45251-00AL	6AH-45251-00	935-1051
REC6AH-48501-02	6AH-48501-00-00	903
REC6AH-W0078-00	6AH-W0078-00	926-1051
REC6AH-W0078-00	6AH-W0078-01	926-1051
REC6AH-W0078-00		849-929-930
REC6AW-11325-00	6AW-11325-00	935-857
REC6AW-11325-00AL	6AW-11325-00	935-982
REC6AW-1132L-00	6AW-1132L-00	857-935
REC6AW-1132L-00AL	6AW-1132L-00	935
REC6AW-1132M-00	6AW-1132M-00	935
REC6AW-1132M-00AL	6AW-1132M-00	935
REC6AW-1132P-00	6AW-1132P-00	857-935
REC6AW-1132P-00AL	6AW-1132P-00	935
REC6AW-1132R-00	6AW-1132R-00	857-933
REC6AW-1132R-00AL	6AW-1132R-00	933
REC6AW-1132S-00	6AW-1132S-00	933
REC6AW-1132S-00AL	6AW-1132S-00	933
REC6AW-1132T-00	6AW-1132T-00	857-934
REC6AW-1132T-00AL	6AW-1132T-00	934
REC6AW-1132U-00	6AW-1132U-00	857-934
REC6AW-1132U-00AL	6AW-1132U-00	934

REF	OEM	
REC6AW-12411-00	6AW-12411-00	914
REC6AW-12411-00	6AW-12411-00	857-915-982
REC6AW-13761-00	6AW-13761-00	868
REC6AW-13907-00	6AW-13907-00	864
REC6AW-13907-00	6P2-13907-00	864
REC6AW-14984-00	6AW-14984-00	857-864-867
REC6AW-43880-22	6AW-43880-00, 01, 02	897
REC6AW-43880-22	6AW-43880-00, 01, 02	897
REC6AW-44311-01	6AW-44311-00	923-1091
REC6AW-44311-01	6AW-44311-01	923
REC6AW-44312-00	6AW-44312-00	1087-1091
REC6AW-44315-00	6AW-44315-00	1091
REC6AW-44322-00	6AW-44322-00	1087-1091
REC6AW-44323-00	6AW-44323-00	1091
REC6AW-44336-00	6AW-44336-00	1091
REC6AW-44352-00	6AW-44352-00	921-1091
REC6AW-44365-00	6AW-44365-00	1087-1091
REC6AW-45251-00	6AW-45251-00	934
REC6AW-45251-00AL	6AW-45251-00	934
REC6AW-45373-00	6AW-45373-00	934
REC6AW-45373-00AL	6AW-45373-00	934-1091
REC6AW-45619-00	6AW-45619-00	934
REC6AW-45619-00AL	6AW-45619-00	934-1091
REC6AW-81800-00	6AW-81800-00	886
REC6AW-8194A-00	6AW-8194A-00	889
REC6AW-81950-00	6AW-81950-00	889
REC6AW-W0078-00	6AW-W0078-00	857-929-930-1091
REC6AW-W4624-00	6AW-W4624-00	1031
REC6B4-11193-A0	6B4-11193-A0	917
REC6B4-11351-A1	6B4-11351-A1	1017
REC6B4-14301-00	6B4-14301-00	869-877
REC6B4-26301-00	6B4-26301-00	908
REC6B4-85520-00	6B4-85520-00	882
REC6B4-85540-01	6B4-85540-01	892
REC6B4-85570-01	6B4-85570-00	880
REC6B4-85570-01	6B4-85570-01	880
REC6B4-85580-00	6B4-85580-00	883
REC6BG-11181-00	6BG-11181-00	969-983-985
REC6BG-13761-00	6BG-13761-00	868
REC6BG-13910-03	6BG-13910-00, 01, 02, 03	865
REC6BG-13915-00	6BG-13915-00	851-860
REC6BG-81800-00	6BG-81800-00	886
REC6BG-81800-00	6BG8180000	886
REC6BG-W0078-00	6BG-W0078-00	851-927-930-1060
REC6BL-11181-00	6BL-11181-00	963-983-985
REC6BL-11325-00	6BL-11325-00	934
REC6BL-11325-00AL	6BL-11325-00	850-934-963
REC6BR-81800-02	63P-81800-00	886
REC6BR-81800-02	6BR-81800-00, 01	886
REC6BX-24360-00	6BX-24360-00	858
REC6C5-13761-00	6C5-13761-00	868
REC6C5-13915-00		852-853-854
REC6C5-13915-00	6C5-13915-00	860
REC6C5-14984-00	6C5-14984-00	852-853-865-867
REC6C5-24251-00	6C5-24251-00	851-852-853-854-859
REC6C5-24410-00	6C5-24410-00	863
REC6C5-43880-01	6C5-43880-00, 01	896
REC6C5-46241-00	6C5-46241-00	963-969-971-973-1031
REC6C5-85885-00	6C5-85885-00	868-878
REC6CB-11181-00	6CB-11181-00	984-985
REC6CB-13016-00	6CB-13016-00	854-855-856-857-867
REC6CB-14984-00	6CB-14984-00	854-856-857
REC6CB-24501-01		854-856-857
REC6CB-45611-00	6CB-45611-00	1087
REC6CB-82310-00	6CB-82310-00	882
REC6CB-W4624-00	6CB-W4624-00	1031
REC6CE-12411-00	6CE-12411-00	857-914-915
REC6CE-44311-01	6CE-44311-00	923
REC6CE-44311-01	6CE-44311-01	923-1087
REC6CE-44315-00	6CE-44315-00	1087
REC6CE-44323-01	6CE-44323-01	1087
REC6CE-44352-00	6CE-44352-00	921
REC6CE-44352-00	6CE-44352-01	1087
REC6CE-44352-00		930

REF	OEM	
REC6CE-45373-00	6CE-45373-00	935-937
REC6CE-45373-00AL		937
REC6CE-81800-01	6CE-81800-00/01	885
REC6CE-W0078-01	6CE-W0078-00	929
REC6CE-W0078-01	6CE-W0078-01	857-929-1087
REC6CJ-11181-00	6CJ-11181-00	973-983-985
REC6CJ-44323-00	6CJ-44323-00	1073
REC6CJ-44324-00	6CJ-44324-00	1073
REC6CJ-81800-01	68F-81800-00, 01, 03	886
REC6CJ-81800-01	6C5-81800-00	886
REC6CJ-81800-01	6CJ-81800-00	886
REC6CJ-W0078-00	6CJ-W0078-00	853-927-930-1073
REC6D0-11631-00	6D0116310284	1029
REC6D0-11642-00	6D0-11642-00	1029
REC6D1-45332-00-CA	6D1-45332-00-CA	1085
REC6D8-13761-00	6D8-13761-00	868
REC6D8-24410-10	6D8-24410-10	863
REC6D8-24560-08		861
REC6D8-24560-08	68V-24560-00	861
REC6D8-24560-08	68V-24560-01	861
REC6D8-24560-08	6D8-24560-08	861
REC6D8-24560-08	6D8-24560-09	861
REC6D8-43880-09	6D8-43880-00, 09	896
REC6D8-WS24A-00		850-851-852-853-854-855-861
REC6D8-WS24A-00	6D8-24563-00	860
REC6D8-WS24A-00	6D8-WS24A-00	860
REC6D9-12411-00	6D9-12411-00	854-914-915
REC6D8-43880-09	6D8-43880-00, 01, 09	896
REC6D9-45551-00	6D9-45551-00	1075
REC6DA-12411-01	6DA-12411-01	856-914-915
REC6DA-W4624-00	6DA-W4624-00	1031
REC6DR-48501-03	68R-48501-00-00	902
REC6DR-48501-03	6AU-48501-00-00	902
REC6DR-48501-03	6DR-48501-00-00	902
REC6E0-11193-A1	6E0-11193-A1	988
REC6E0-11631-00-98K	6E0-11631-00-98	988-1026-1030
REC6E0-11651-01	6E0-11651-01	988-991-1023
REC6E0-24411-00	6E0-24411-00	865
REC6E0-24434-00	6G1-24431-01	866
REC6E0-24435-00	6E0-24435-00	866
REC6E0-24471-00	6E0-24471-00	865
REC6E0-26301-01	6E0-26301-01	908
REC6E0-41112-A1	6E0-41112-A1	917-988
REC6E0-41114-A1	6E0-41114-A1	917-988
REC6E0-43118-01	6E0-43118-00	912
REC6E0-43118-01	6E0-43118-01	912
REC6E0-44322-02	6E0-44322-02	929-931-1095
REC6E0-44352-00	6E0-44352-00	921-929-931-1045-1095
REC6E0-45113-A1	6E0-45113-A1	988
REC6E0-45251-12AL		849
REC6E0-45251-12	6E0-4525-12	934
REC6E0-45251-12AL	6E0-4525-12	849-850-851-852-853-934-1097
REC6E0-45315-A0	6E0-45315-A0	925
REC6E0-45316-00	6E0-45316-09	1095
REC6E0-45317-00	6E0-45317-09	1095
REC6E0-45511-01	6E0-45511-01	1095-1131
REC6E0-45511-11	6E0-45511-11	1095-1131
REC6E0-45551-00	6E0-45551-00	1095-1131
REC6E0-45560-00	6E0-45560-00	1095-1131
REC6E0-45570-00	6E0-45570-00	1095-1131
REC6E0-45611-01	6E0-45611-01	1095
REC6E0-45631-00	6E0-45631-00	1095-1131
REC6E0-85570-00	6E0-85570-00	880
REC6E0-W0001-C1	6E0-W0001-C1	919-1043-1095
REC6E0-W0078-A2	6E0-W0078-00	927
REC6E0-W0078-A2	6E0-W0078-01	927
REC6E0-W0078-A2	6E0-W0078-02	927
REC6E0-W0078-A2	6E0-W0078-A2	927-1043-1095
REC6E0-W0078-A2		931
REC6E3-14301-05	6E3-14301-05	869-877
REC6E5-11181-A0	6E5-11181-A2	1011-1015-1018
REC6E5-11193-A0	6E5-11193-A0	1011-1018
REC6E5-11325-00	6E5-11325-00	937-955

REF	OEM	
REC6E5-11325-00AL	6E5-11325-00	849-854-856-857-937-981-1011-1013
REC6E5-11381-A1	6E5-11381-A1	1036
REC6E5-11381-A1	6E5-11381-A2	1011-1013
REC6E5-11447-00	6E5-11447-00	1011-1013
REC6E5-11610-02	6E5-11610-02	1029-1031
REC6E5-11634-00	6E5-11634-00	1029
REC6E5-11651-00		1024
REC6E5-12411-02	6E5-12411-00	914
REC6E5-12411-02	6E5-12411-01	914-988-989-995-997-999
REC6E5-12411-02	6E5-12411-02	914
REC6E5-12411-02	6E5-12411-02	915
REC6E5-12411-30	688-12411-10	1009
REC6E5-12411-30	6E5-12411-10	914
REC6E5-12411-30	6E5-12411-20	914
REC6E5-12411-30	6E5-12411-30	914-993-1003-1011-1013
REC6E5-12411-30		915
REC6E5-13621-A1	6E5-13621-A1	1036
REC6E5-13645-A1-00	6E5-13645-A1	1036
REC6E5-14198-A2	6E5-14198-A2	1036
REC6E5-14323-03	6E5-14323-03	875
REC6E5-14328-01	6E5-14328-01	875
REC6E5-14385-02	6E5-14385-02	876-877
REC6E5-14386-01	6E5-14386-01	875
REC6E5-14416-A1	6E5-14416-A1	1036
REC6E5-14483-A1	6E5-14483-A1	1036
REC6E5-14546-00	6E5-14546-00	874-877
REC6E5-24410-03	6E5-24410-01-00	863
REC6E5-24411-00	6E5-24411-00-00	866
REC6E5-24434-02	6E5-24434-02	866
REC6E5-24435-00	6E5-24435-00	866
REC6E5-24471-00	6E5-24471-00	866
REC6E5-41112-A1	6E5-41112-A1	919-1011
REC6E5-41134-A0	6E5-41134-A0	1033
REC6E5-41135-A0	6E5-41135-A0	1033
REC61A-44311-00	6E5-44311-00	930-932-933-1127
REC6E5-44315-A0	6E5-44315-A0	1079-1083-1085-1125-1127-1129-1083
REC6E5-44322-00	6E5-44322-00	1085 1125 1127 1129 932
REC6E5-44323-00-40	6E5-44323-00	1127-932-933 924-930-932-933-1125 921-930-932-933-1079-1083-1085-1089-1125-1127-1129-1130
REC6E5-44365-00	6E5-44365-00	1083-1127
REC6E5-44366-00	6E5-44366-00	1127
REC6E5-45113-A2	6E5-45113-A0	1017-1018
REC6E5-45114-00	6E5-45114-A0	1034
REC6E5-45251-00	6E5-45251-00	934
REC6E5-45251-00AL	6E5-45251-00	934
REC6E5-45321-00	6E5-45321-00	1079-1083-1125-1127
REC6E5-45331-00-94	6E5-45331-00-94	1125-1127
REC6E5-45331-00-94	6E5-45331-00-95	1135-1079-1083
REC6E5-45332-00-94	6E5-45332-00-94	1125
REC6E5-45332-00-94	6E5-45332-00-CA	1079
REC6E5-45344-00	6E5-45344-00	1125-1127-1129-1079-1083-1085-1089-937-1125-1121-1125
REC6E5-45371-01	6E5-45371-01	1125
REC6E5-45371-10	6E5-45371-10	934
REC6E5-45371-10AL	6E5-45371-10	854-855-937-934-854-855-937-1079
REC6E5-45536-00	6E5-45536-00	1079-1083-1125
REC6E5-45551-00	6E5-45551-02	1125-1135
REC6E5-45560-00	6E5-45560-01	1125-1135
REC6E5-45570-00	6E5-45571-01	1125-1135
REC6E5-45576-00	6E5-45576-00	1079-1125
REC6E5-45611-00	6E5-45611-00	1079
REC6E5-45611-00	6E5-45611-01	1125
REC6E5-45611-00		1135-1136
REC6E5-45631-00	6E5-45631-01	1125-1135
REC6E5-45633-01	6E5-45633-01	1079-1081-1087-1125-1127-1135-1136

REF	OEM	
REC6E5-45634-01	6E5-45634-01	1079-1081-1125
REC6E5-45987-00	63P-45987-00	1079-1081-1127-1125-1144
REC6E5-81800-12	6E5-81800-10, 11, 12	884
REC6E5-8195A-01	6E5-8195A-01	889
REC6E5-8195A-01	6E5-8195C-01	889
REC6E5-85540-12	6E5-85540-12, 11, 10	893
REC6E5-85570-11	6E5-85570-10	881
REC6E5-85570-11	6E5-85570-11	881
REC6E5-W0001-A2	6E5-W0001-A2	1016-1017-1018
REC6E5-W0093-07	6E5-W0093-07	874
REC6E5-W0093-08	6E5-W0093-08	874
REC6E7-11111-01-1S	6E7-11111-01-1S	993
REC6E7-11181-00		1018
REC6E7-11631-00K	6E7-11631-00	1026
REC6E7-11631-00K	6E7-11631-00-97	993-1030
REC6E7-11635-00K	6E7-11635-00	993-1026
REC6E7-11636-00K	6E7-11636-00	993-1026
REC6E7-14227-00	6E7-14227-00	871
REC6E7-14385-00	6E7-14385-00	876-877
REC6E7-44366-00	6E7-44366-00	1099
REC6E7-45331-00-CA	6E7-45331-00-9M	1099
REC6E7-45501-00	6E7-45501-00	1099
REC6E7-45501-11	6E7-45501-10	1099-1131-1132
REC6E7-45536-00	6E7-45536-00	1099
REC6E7-45551-00	6E7-45551-00	1099-1131-1132
REC6E7-45560-01	6E7-45560-00	1099
REC6E7-45560-01	6E7-45560-01	1049-1051-1101
REC6E7-45560-01		1131-1132
REC6E7-45570-00	6E7-45570-00	1051
REC6E7-45570-00	6E7-45571-00	1049-1099-1101
REC6E7-45570-00		1131-1132
REC6E7-45987-00	6E7-45987-00	1049-1099
REC6E7-45987-00	6E7-45987-01	1051-1101
REC6E7-45987-00		1144
REC6E7-85570-19	6E7-85570-19-00	880
REC6E7-W0001-A1	6E7-W0001-00	1015
REC6E7-W0001-A1	6E7-W0001-A1	1015
REC6E7-W0001-A1		1018
REC6E7-W0093-01	6E7-W0093-04	872
REC6E8-14390-12	6E8-14390-12	874
REC6E8-45251-00	6E8-45251-00	937
REC6E8-45251-00AL	6E8-45251-00	937-1099
REC6E8-45251-02	6E8-45251-02	935
REC6E8-45251-02AL	6E8-45251-02	935
REC6E9-12413-00-1S	6E9-12413-00-1S	916-1001
REC6E9-12414-A1	6E9-12414-A1	916-1001
REC65W-82575-01	6E9-82575-00	894
REC6EE-G4311-00	6EE-G4311-00	923
REC6EE-G4322-00	6EE-G4322-00	925
REC6EE-G4323-00	6EE-G4323-00	924
REC6EE-G4366-01	6EE-G4366-01	917
REC6EE-W0078-01	6BX-WG0078-00	925
REC6EE-W0078-01	6EE-W0078-00	925
REC6EE-W0078-01	6EE-W0078-01	925
REC6F5-11181-A2	6F5-11181-A1	1001
REC6F5-11181-A2	6F5-11181-A2	1015
REC6F5-11181-A2		1018
REC6F5-11515-00	6F5-11515-00	999-1001
REC6F5-11610-00	6F5-11610-00	1027
REC6F5-11610-00	6F6-11610-00	1001
REC6F5-11610-20	6F5-11610-20	1027
REC6F5-11610-20	6F6-11610-20	1001
REC6F5-11633-00	6F5-11633-00	999-1001-1027-1023-1024
REC6F5-11651-00	6F5-11651-00	999-1001-1023-1024
REC6F5-11681-00	6F5-11681-00	1001-1024
REC6F5-12411-03	6F5-12411-00	914
REC6F5-12411-03	6F5-12411-01	914
REC6F5-12411-03	6F5-12411-02	914-1001-1005
REC6F5-12411-03	6F5-12411-03	914
REC6F5-12411-03		915
REC6F5-13621-A1	6F5-13621-A1	1035
REC6F5-13645-A0	6F5-13645-A1	1035
REC6F5-13646-A2	6F5-13646-A1	1035
REC6F5-14198-A1	6F5-14198-A1	1035
REC6F5-14323-00	6F5-14323-01	875
REC6F5-14390-21	6F5-14390-21	874
REC6F5-14483-00	6F5-14483-00	871

REF	OEM	
REC6F5-15396-01-5B	6F5-15396-01-5B	1001
REC6F5-24563-00	6F5-24563-00	859-859-861
REC6F5-26311-00	6F5-26311-00	908
REC6F5-41111-01-1S	6F5-41111-01-1S	1001
REC6F5-41112-A0	6F5-41112-A0	918-1001
REC6F5-41113-A0-1S	6F5-41113-01-1S	1001
REC6F5-41114-A0	6F5-41114-A0	918-1001
REC6F5-44352-00	6F5-44352-00	921-1113
REC6F5-44352-00	6F5-44352-002	1117-931
REC6F5-45113-A0	6F5-45113-A0	1001-1017-1018
REC6F5-45312-00-4D	6F5-45312-01-4D	1113
REC6F5-45551-00	6F5-45551-00	1113-1133-1134
REC6F5-45560-00	6F5-45560-00	1113-1133-1134
REC6F5-85540-22	6F5-85540-22	892
REC6F5-85570-11	F5-85570-13	880
REC6F5-W0001-C0	6F5-W0001-C0	920-1113
REC679-W0078-A1	6F5-W0078-00	927
REC679-W0078-A1	6F5-W0078-A0	1113
REC679-W0078-A1		931
REC6F6-11111-00-1S	6F6-11111-00-1S	1001
REC6F6-11191-00-1S	6F6-11191-00-1S	1001
REC6F6-11193-A1	6F6-11193-A1	1001-1019
REC6F6-11400-02	6F6-11400-01	1001
REC6F6-11631-00K	6F6-11631-00-95	1001-1027
REC6F6-11635-00K	6F6-11635-00	1001-1027
REC6F6-11636-00K	6F6-11636-00	1001-1027
REC6F6-13610-00	6F6-13610-00	875
REC6F6-14301-06	6F6-14301-06	869
REC6F6-14341-00	6F6-14341-00	874
REC6F6-14385-00	6F6-14385-00	876
REC6F6-45611-00	6F6-45611-00	1113-1133-1134
REC6F6-85530-01	6F6-85530-01	881
REC6F6-85540-01	6F6-85540-01	892
REC6F6-W0001-02	6F6-W0001-02	1000-1016
REC6F6-W0093-00	6F6-W0093-00	873
REC6F8-11181-A0	6F8-11181-A1	987-1014-1018
REC6FM-12411-00	6FM-12411-00	850-914-915
REC6FP-12411-00	6FP-12411-00	854-914-915
REC6FP-81800-01	6FP-81800-01	886
REC6GO-11412-00	69P-11412-00	995-1020
REC6GO-11422-00	69P-11422-00	995-1020
REC6GO-11681-00		1024
REC6GO-85540-11	6GO-85540-11	893
REC6G1-11193-A1	6G1-11193-A1	917-989
REC6G1-11610-00	6G1-11610-00	988-1026
REC6G1-11610-00	6NO-E1603-00	989
REC6G1-11610-00		1030
REC6G1-11633-00	6G1-11633-00	988-991-1026-1023
REC6G1-11681-00	6G1-11681-00	988-989-991-1023
REC6G1-14301-01	6G1-14301-01	869-877
REC6G1-14546-00	6G1-14546-01	874-877
REC6G1-14985-00	647-14323-00	876-877
REC6G1-24304-02	6G1-24304-02	858
REC6G1-24411-00	6G1-24411-00	865
REC6G1-24431-01	6G1-24431-01	866
REC6G1-24471-00	6G1-24471-00	865
REC6G1-41112-A1	6G1-41112-A1	917-989
REC6G1-41114-A0	6G1-41114-A0	917-989
REC6G1-44315-A0	6G1-44315-A0	931-1096
REC6G1-44322-00	6G1-44322-00	931-1096
REC6G1-44323-00	6G1-44323-00	931-1096
REC6G1-44328-00	6G1-44328-00	1096
REC6G1-44352-00	6G1-44352-00	921-931-1096
REC6G1-45113-A1	6G1-45113-A1	989-1017
REC6G1-45315-A0	6G1-45315-A0	1096
REC6G1-45316-09	6G1-45316-09	1047
REC6G1-45317-09	6G1-45317-09	1047
REC6G1-45362-09	6G1-45362-09	1047
REC6G1-45611-01	6G1-45611-01	1096-1131
REC6G1-45631-00	6G1-45631-00	1096-1131
REC6G1-81970-62	664-81970-60, 61, 62	890
REC6G1-81970-62	676-81970-00	890
REC6G1-81970-62	6E9-81970-70	890
REC6G1-81970-62	6G1-81970-00, 60, 61, 62, A0	890
REC6G1-81970-62		890
REC6G1-W0001-C1	6G1-W0001-C0	919
REC6G1-W0001-C1	6NO-W0001-20	1096
REC6G1-W0078-A1	6G1-W0078-00	926
REC6G1-W0078-A1	6G1-W0078-01	926

REF	OEM	
REC6G1-W0078-A1	6G1-W0078-A1	926-1096
REC6G1-W0078-A1	6NO-W0078-A0	926
REC6G1-W0078-A1		931
REC6G1-W0093-00	6G1-W0093-00	872-877
REC6G5-11181-A2	6G5-11181-A3	1013-1015-1018
REC6G5-11193-A0	6F5-11193-A0	1013
REC6G5-11193-A0	6G5-11193-A1	1019
REC6G5-11382-A1	6G5-11382-A1	919-1011-1013
REC6G5-11631-00K	6G5-11631-00-93	1029-1031
REC6G5-11642-00K	6G5-11642-00-93	1029-1031
REC6G5-13645-A1	6G5-13645-A2	1036
REC6G5-14416-A1	6G5-14416-A1	1036
REC6G5-14483-01	6G5-14483-A1	1036
REC6G5-41112-A1	6G5-41112-A1	919-1013
REC6G5-41112-A1	6G5-41114-A0	919-1013
REC6G5-41134-A1	6G5-41134-A1	1033
REC6G5-41217-01	6G5-41217-01	877
REC6G5-43864-00	6G5-43864-00	898
REC6G5-43880-02	6G5-43880-00, 01, 02	897
REC6G5-44323-00	6G5-44323-00	1083-1085-1127-1129
REC6G5-44323-00	6G5-44323-01	924
REC6G5-44323-00		930-932-933
REC6G5-45113-A1	6G5-45113-A1	1011-1013
REC6G5-45113-A1	6G5-45113-A2	1018
REC6G5-45113-A1		1018
REC6G5-45114-A0	6G5-45114-A1	1034
REC6G5-45251-02		937
REC6G5-45251-02AL		854-937
REC6G5-45383-01	6G5-45383-01	1081-1127
REC6G5-45384-00	6G5-45384-00	1081-1127
REC6G5-45501-21	6G5-45501-21	1127-1135-1136
REC6G5-45551-00	6G5-45551-01	1127-1135-1136
REC6G5-45560-00	6G5-45560-01	1127-1135-1136
REC6G5-45571-02	6G5-45571-02	1127-1135-1136
REC6G5-45576-10	6G5-45576-10	1081
REC6G5-45631-00	6G5-45631-00	1127-1135-1136
REC6G5-81960-A0	6G5-81960-A0	890
REC6G5-W0078-A1	6G5-W0078-00	928
REC6G5-W0078-A1	6G5-W0078-01	928
REC6G5-W0078-A1	6G5-W0078-A1	928-1127
REC6G5-W0078-A1		932-933
REC6G8-11181-A1	6G8-11181-00	949
REC6G8-11181-A1	6G8-11181-A1	983
REC6G8-11181-A1		985
REC6G8-11325-00		937
REC6G8-11325-00AL	6G8-11325-00	849-937-948-949-955-963-969-971-973-949-985
REC6G8-11351-A0	6G8-11351-00	948
REC6G8-12414-A0	6OR-E2414-A0	948
REC6G8-12414-A0	6G8-12414-00	949
REC6G8-12414-A0	6G8-12414-A0	915
REC6G8-13440-00	6G8-13440-00	862
REC6G8-45251-01	6G8-45251-01	935
REC6G8-45251-01AL	6G8-45251-01	935
REC6G8-46241-00	6G8-46241-00	1031
REC6G8-48501-03-00	6G8-48501-03-00	903
REC6G8-81870-00	6G8-81870-00	894
REC6G8-81960-A1	6G8-81960-A1	890
REC6HO-81960-00	6HO-81960-00	891
REC6H1-11631-03K	6H1-11631-03-95	1028-1030-1031
REC6H1-15359-01-94	6H1-15359-01-94	1009
REC6H1-43800-17-8D	6H1-43800-13-4D	898
REC6H1-43800-17-8D	6H1-43800-14-4D	898
REC6H1-43800-17-8D	6H1-43800-15-4D	898
REC6H1-43800-17-8D	6H1-43800-16-4D	898
REC6H1-43800-17-8D	6H1-43800-17-8D	898
REC6H1-43880-00	6H1-43880-00	896
REC6H1-43880-02	6H1-43880-02	895
REC6H1-44144-00	6H1-44144-00	1123
REC6H1-45214-00	6H1-45214-00	1073-1075
REC6H1-45215-00	6H1-45215-00	1073-1075
REC6H1-45251-01		937
REC6H1-45251-01AL		937
REC6H1-45251-03		937
REC6H1-45251-03AL		853-854-855-937
REC6H1-45611-00	6H1-45611-01-00	1123-1134-1135
REC6H1-45631-01	6H1-45631-01-00	1123
REC6H1-45634-02	6H1-45634-02	1123

REF	OEM	
REC6H1-81950-01	6H1-81950-00, 01	889
REC6H1-82563-11-00	6H1-82563-11-00	906
REC6H1-W0093-01-00	6H1-W0093-01	873
REC6H1-W0093-10	6H1-W0093-10	873
REC6H2-81960-10	6H2-81960-10	890
REC6H2-85540-13	6H2-85540-10, 11, 12, 13	893
REC6H2-W0001-20	6H2-W0001-20	920
REC6H2-W0093-10	6H2-W0093-10	873
REC6H3-11181-A0	6H3-11181-A2	1007-1014-1018
REC6H3-11193-A1	6H3-11193-A1	1007-1019
REC6H3-11631-01K	6H3-11631-01-96	1007-1026-1030
REC6H3-11633-00	6H3-11633-00	1007-1024-1026-1028
REC6H3-11635-01K	6H3-11635-01	1007
REC6H3-11635-01K	6H3-11635-01	1026
REC6H3-11636-01K	6H3-11636-01	1007-1026
REC6H3-12411-10	6H3-12411-00	914
REC6H3-12411-10	6H3-12411-01	914
REC6H3-12411-10	6H3-12411-10	914-1007
REC6H3-12411-10	6H3-12411-11	914
REC6H3-12411-10		915
REC6H3-12414-A1	62Y-12414-00	915-951-959-963-965-969-971-973-975
REC6H3-12414-A1	6H3-12414-A1	915-1007
REC6H3-12414-A1		850-851-852-853-1036
REC6H3-13621-A1	6H3-13621-A1	1036
REC6H3-13622-A1	6H3-13622-A1	1035
REC6H3-14198-A1	6H3-14198-A1	1035
REC6H3-14590-00	6H3-14590-01	874-877
REC6H3-41112-A0	6H3-41112-A0	918-1007
REC6H3-41114-A0	6H3-41114-A0	918-1007
REC6H3-41217-00	6H3-41217-00	877
REC6H3-44311-00	6H3-44311-00	923
REC6H3-44315-00		930-931
REC6H3-44323-00	6H3-44323-00-00	923-930-931
REC6H3-44324-A0-00	6H3-44324-A0-00	925
REC6H3-44352-00	697-44352-00	1119
REC6H3-44352-00	6H3-44352-00	921-1071-1073
REC6H3-44352-00		930-931
REC6H3-45113-00	6H3-45113-00	1007-1018
REC6H3-45114-A1	6H3-45114-A1	1033
REC6H3-45123-00	6H3-45123-00	1032
REC6H3-81800-11	6H3-81800-10, 11	885
REC6H3-82510-03	6H3-82510-00, 01, 02, 03	888
REC6H3-85520-00	6H3-85520-00	882
REC6H3-85570-10	6H3-85470-10	881
REC6H3-W0001-02	6H3-W0001-02	1016-1018
REC6H3-W0001-22	6H3-W0001-22	919
REC6H3-W0078-02	6H3-W0078-00	852-853-928-930-931
REC6H3-W0093-02	6H3-W0093-02	873-877
REC6H4-11181-00	6H4-11181-02	1014-1018
REC6H4-11193-A1	6H4-11193-A0	1019
REC6H4-11610-00-00	6H4-11610-00	1027-1030
REC6H4-11631-00K	6H4-11631-00-96	1027-1030
REC6H4-11631-01K	6H4-11631-01-95	1003-1027-1030
REC6H4-11634-01	6H4-11634-01	1003-1027
REC6H4-11635-00K	6H4-11635-00	1027
REC6H4-11635-01K	6H4-11635-01	1003-1027
REC6H4-11636-00K	6H4-11636-00	1027
REC6H4-11636-01K	6H4-11636-01	1003-1027
REC6H4-11651-00		1024
REC6H4-14198-01	6H4-14198-01	1035
REC6H4-14984-00	6H4-14984-00	871
REC6H4-14985-01	650-14385-00	876
REC6H4-14985-01	6H4-14985-00	876
REC6H4-14985-01	6H4-14985-01	876
REC6H4-14985-01	6M6-14385-00	876
REC6H4-41114-A0	6H4-41114-A0	918-1003
REC6H4-44352-02	6H4-44352-00	1067
REC6H4-44352-02	6H4-44352-02	921-1055-1059-1063-1105-1107-1109-1111-929-930-931
REC6H4-44352-02		1003
REC6H4-45113-00	6H4-45113-00	1017
REC6H4-45113-00	6H4-45113-A0	1017
REC6H4-45113-00		1018
REC6H4-45551-00	6H4-45551-00	1109-1133-1134
REC6H4-45560-00	6H4-45560-00	1109-1133-1134

REF	OEM	
REC6H4-45570-00	6H4-45571-00	1109-1133-1134
REC6H4-45631-00		1133-1134
REC6H4-81800-12	6H4-81800-10, 11, 12	884
REC6H4-W0078-00	6H4-W0078-00	927
REC6H4-W0078-00	6H4-W0078-A0	1109
REC6H4-W0078-00		931
REC6H4-W0093-01-00	6H4-W0093-01	873
REC6H4-W0093-03	6H4-W0093-03	873
REC6H5-43880-09	6H5-43880-00, 01, 02, 09	895
REC6H9-45551-00	6H9-45551-00	1115-1133
REC6J1-11610-00	6J1-11610-00	988
REC6J4-81800-01	6F5-81800-10, 11	884
REC6J4-81800-01	6G8-81800-10, 11	884
REC6J4-81800-01	6J4-81800-00, 01	884
REC6J8-11181-A2	6J8-11181-A1	997
REC6J8-11181-A2	6J8-11181-A2	1014
REC6J8-11181-A2		1018
REC6J8-11325-00	6J8-11325-00	937
REC6J8-11325-00AL	6J8-11325-00	937-995
REC6J8-11631-02	6J8-11631-02-97	997-1027-1030
REC6J8-24471-00	6J8-24471-00	866
REC6J8-45113-00	6J8-45113-A0	997-1017-1018
REC6J8-48501-03-4D	6J8-48501-00-00	903
REC6J8-48501-03-4D	6J8-48501-03-4D	903
REC6J8-48501-11	6J8-48501-11	903
REC6J8-48501-11	6J8-48501-11-00	903
REC6J8-W0078-A2	6J8-W0078-A1	927
REC6J8-W0078-A2	6J8-W0078-C2	1107
REC6J8-W0078-A2		931
REC6J9-45371-01	6J9-45371-01	937
REC6J9-45371-01AL	6J9-45371-01	856-937-1081
REC6J9-45611-00	6J9-45611-01	1081-1127-1135-1136
REC6K1-45371-00	6K1-45371-00	934
REC6K1-45371-00AL	6K1-45371-00	934
REC6K1-45371-02	6K1-45371-02	934
REC6K1-45371-02AL	6K1-45371-02	934-856
REC6K1-82570-13	6K1-82570-00	904
REC6K1-82570-13	6K1-82570-02	904
REC6K1-82570-13	6K1-82570-03	904
REC6K1-82570-13	6K1-82570-04	904
REC6K1-82570-13	6K1-82570-05	904
REC6K1-82570-13	6K1-82570-06	904
REC6K1-82570-13	6K1-82570-07	904
REC6K1-82570-13	6K1-82570-08	904
REC6K1-82570-13	6K1-82570-10	904
REC6K1-82570-13	6K1-82570-11	904
REC6K1-82570-13	6K1-82570-12	904
REC6K1-82570-13	6K1-82570-13	904
REC6K1-82575-01	6K1-82575-00-00	905
REC6K1-82575-01	6K1-82575-01	905
REC6K1-8258A-40-00	61A-8258A-00-00	907
REC6K1-8258A-40-00	6K1-8258A-40-00	907
REC6K1-8258A-40-00		907
REC6K4-11432-00		1020
REC6K5-11601-02	6K5-11601-02	1007-1026-1028-1030
REC6K5-11601-12	6K5-11601-12	1007-1026-1028
REC6K5-11601-22	6K5-11601-22	1007-1026-1028
REC6K5-11631-03K	6K5-11631-03-95	1028-1030
REC6K5-11635-03K	6K5-11635-03	1028
REC6K5-11636-03K	6K5-11636-03	1028
REC6K5-11651-00	6K1-11651-00	1025
REC6K5-11681-00		1024
REC6K5-14301-03	6K5-14301-03 + 6K5-14302-03 + 6K5-14303-03	870-877
REC6K5-45551-00		1132-1134
REC6K5-45560-00		1132-1134
REC6K5-45570-00		1134
REC6K5-W0001-02	6K5-W0001-02	1016
REC6K7-11633-00	6K7-11633-00	1029-1024-1025
REC6K7-14483-00	6K7-14483-00	1036
REC6K8-41122-A1	6K8-41122-A1	918-995
REC6K8-41124-A1	6K8-41124-A1	918-995
REC6L2-14384-00-00	6L2-14384-00	871
REC6L2-14385-00	6L2-14385-00	876-877
REC6L2-14399-00	6L2-14399-00	871
REC6L2-26301-00	6L2-26301-00	808
REC6L2-44322-00		931

REF	OEM	
REC6L2-44352-00	6L2-44352-00	921-850-931
REC6L2-44367-00	6L2-44367-00	1051-1055-1105-850-929-930-931
REC6L2-45113-A2	6L2-45113-A1	1017-1018
REC6L2-45611-00	6L2-45611-00	1105-1132-1133
REC6L2-45987-00	6L2-45987-01	1053-1105-1107-1144
REC6L2-48501-11-00	6L2-48501-11-00	903
REC6L2-W0078-00	6L2-W0078-00	927-931
REC6L2-W0093-00	6L2-W0093-00	872
REC6L5-14301-03	6L5-14301-03	870-877
REC6L5-44323-00	6L5-44323-00	923
REC6L5-44352-00	6L5-44352-00	921-929
REC6L5-45251-03AL	6L5-45251-03	848
REC6L5-45251-03	6L5-45251-03	848-937
REC6L5-45251-03AL	6L5-45251-03	937-1041-1043-1045-1093-1095
REC6L8-G3118-01	6L8-G3118-01	912
REC6N0-G2177-00	6N0-G2177-00	911
REC6N0-G5551-00	6N0-G5551-00	1096-1131
REC6N0-G5560-00	6N0-G5560-00	1096-1131
REC6N0-G5571-00	6N0-G5571-00	1096-1131
REC6N0-WG525-00	6N0-WG525-00	934
REC6N0-WG525-00AL	6N0-WG525-00	934
REC6N6-W0078-02	6E5-W0078-02	1125
REC6N6-W0078-02	6N6-W0078-00	928
REC6N6-W0078-02		930-932
REC6N7-11411-00	6N7-11411-00	1011-1020
REC6P2-13761-00	6P2-13761-00	868-869
REC6P2-13906-00	6P2-13906-00	867-869
REC6P2-14984-00	6P2-14984-00	867-856-857-864
REC6P2-44323-00	6P2-44323-0	924-1089-930-933
REC6P2-45501-01	6P2-45501-01	1089
REC6P2-45501-11	6P2-45501-10	1089
REC6P2-46241-02	6P2-46241-01	981
REC6P2-46241-02	6P2-46241-02	1031
REC6P2-81960-03	6P2-81960-02,03	891
REC6P2-W0078-00	61P2-W0078-00	1089
REC6P2-W0078-00	6P2-W0078-00	929
REC6P2-W0078-00		857-930-933
REC6P2-WS245-00	6P2-24563-00	860
REC6P2-WS245-00	6P2-WS245-00	860
REC6P2-WS245-00		861
REC6P3-24564-00	6P3-24564-00	860-855-856-857
REC6P3-WS24A-00	6P3-24563-00	860
REC6P3-WS24A-00	6P3-WS24A-00	860
REC6P3-WS24A-00	6P3-WS24A-01	860
REC6P3-WS24A-00		855-856-857-861
REC6R3-24560-00		861
REC6R3-81960-10	6R3-81960-10	891
REC6R3-82105-J3	6R3-82105-J2-00	887
REC6R3-82105-J3	6R3-82105-J3	887
REC6R3-82563-01	6R3-82563-01	895
REC6R3-82563-01	6R3-82563-01	895
REC6R3-85570-01	6R3-85570-01	881
REC6R3-W0001-03	6R3-W0001-A3	1016
REC6R5-11603-00	6R5-11603-00	1028-1031
REC6R5-11631-01K	6R5-11631-11-93	1029-1031
REC6R5-11631-11K	6R5-11361-11-93	1011
REC6R5-11631-11K	6R5-11631-11-93	1028-1031
REC6R5-11633-00	6R5-11633-10	1011-1013-1028-1030-1024
REC6R5-11634-00	6R5-11634-00	1029
REC6R5-11634-00	6R5-11634-10	1011-1013-1028-1030
REC6R5-11642-01K	6R5-11642-11-93	1011-1029-1031
REC6R5-11642-11K	6R5-11642-11-93	1028-1031
REC6R5-11650-10	6F5-11650-11	1013
REC6R5-11650-10	6R5-116950-0	1011
REC6R7-11181-A0	6R7-11181-A1	1014-1018
REC6S1-85885-00	6S1-85885-00	878-868-869
REC6T4-45836-00AL	6T4-45836-00	934
REC6T5-45251-00	6T5-45251-00	934
REC6T5-45251-00AL	6T5-45251-00	934
REC6T5-45371-00	6T5-45371-00	934
REC6T5-45371-00AL	6T5-45371-00	934
REC6T5-45373-00	6T5-45373-00	934
REC6T5-45373-00AL	6T5-45373-00	934
REC6U0-45251-01	6U0-45251-01	933

REF	OEM	
REC6U0-45251-01AL	6U0-45251-01	933
REC6U3-45251-01	6U3-45251-01	934
REC6U3-45251-01AL	6U3-45251-01	934
REC6U4-45251-01	6U4-45251-01	934
REC6U4-45251-01AL	6U4-45251-01	934
REC6U4-45373-01	6U4-45373-01	933
REC6U4-45373-01AL	6U4-45373-01	933
REC6X0-82563-02	6X0-82563-01-00	906
REC6X0-82563-02	6X0-82563-02	906
REC6X3-48206-11	6X3-48206-01	901
REC6X3-48206-11	6X3-48206-02	901
REC6X3-48206-11	6X3-48206-03	901
REC6X3-48206-11	6X3-48206-10	901
REC6X3-48206-11	6X3-48206-11	901
REC6X3-48206-22	6X3-48206-21	900
REC6X3-48206-22	6X3-48206-21-00	900
REC6X6-82570-50-00	6X6-82570-50-00	905
REC6X6-82570-A0-00	6X6-82570-A0-00	905
REC6X6-8258A-11	6X6-8258A-10	907
REC6X6-8258A-11	6X6-8258A-11	907
REC6X6-8258A-21	6X6-8258A-21	907
REC6X6-8258A-31	6X6-8258A-30	907
REC6X6-8258A-31	6X6-8258A-31	907
REC6X6-8258A-41	6X6-8258A-41	907
REC6X6-8258A-61	6X6-8258A-60	907
REC6X6-8258A-61	6X6-8258A-61	907
REC6X6-8258A-71	6X6-8258A-71	907
REC6X6-8258A-81	6X6-8258A-81	907
REC6Y8-83553-02	6Y8-83553-02	887
REC703-48203-23	703-48203-12-00	900
REC703-48203-23	703-48203-23	900
REC703-48205-16	703-48205-10	899
REC703-48205-16	703-48205-11	899
REC703-48205-16	703-48205-12	899
REC703-48205-16	703-48205-13	899
REC703-48205-16	703-48205-14	899
REC703-48205-16	703-48205-15	899
REC703-48205-16	703-48205-16	899
REC703-48205-16	703-48205-17	899
REC703-48205-16	703-48205-18	899
REC703-48205-16	703-48205-1A	899
REC703-48205-16	703-48205-1B	899
REC703-48205-16	703-48205-20	899
REC703-48205-16	703-48205-21	899
REC703-48206-22	703-48206-21	901
REC703-48206-22	703-48206-22	901
REC703-48207-24	703-48207-17	901
REC703-48207-24	703-48207-24	901
REC703-48230-14	703-48230-10	899
REC703-48230-14	703-48230-11	899
REC703-48230-14	703-48230-12	899
REC703-48230-14	703-48230-13	899
REC703-48230-14	703-48230-14	899
REC703-48230-14	703-48230-15	899
REC703-48230-14	703-48230-16	899
REC703-48230-14	703-48230-17	899
REC703-48230-14	703-48230-18	899
REC703-48230-14	703-48230-1A	899
REC703-48230-14	703-48230-20	899
REC703-48230-14	703-48230-21	899
REC703-48230-14-P	703-48230-14-P	901
REC703-48230-22	703-48230-12	900
REC703-48230-22	703-48230-22	900
REC703-48272-12	703-48272-12	900
REC703-48272-12-00	703-48272-12-00	900
REC703-82510-44	703-82510-43	888
REC703-82563-21	703-82563-20	904
REC703-82563-21	703-82563-21	904
REC704-48205-R0	704-48205-11	902
REC704-48205-R0	704-48205-12	902
REC704-48205-R0	704-48205-13	902
REC704-48205-R0	704-48205-14	902
REC704-48205-R0	704-48205-15	902
REC704-48205-R0	704-48205-B0	902
REC704-48205-R0	704-48205-B1	902
REC704-48205-R0	704-48205-P0	902
REC704-48205-R0	704-48205-P1	902
REC704-48205-R0	704-48205-R0	902
REC704-48207-R0	704-48207-20	902
REC704-48207-R0	704-48207-21	902

REF	OEM	
REC704-48207-R0	704-48207-22	902
REC704-48207-R0	704-48207-30	902
REC704-48207-R0	704-48207-31	902
REC704-48207-R0	704-48207-39	902
REC704-48207-R0	704-48207-P1	902
REC704-48207-R0	704-48207-R0	902
REC704-82563-31-00	704-82563-31-00	906
REC704-82563-42	704-82563-40	905
REC704-82563-42	704-82563-41	905
REC704-82563-42	704-82563-42	905
REC704-82563-52	704-82563-52/00	906
REC704-82563-H2-00	704-82563-H2-00	906
REC704-82563-J2	704-82563-J0	905
REC704-82563-J2	704-82563-J1	905
REC704-82563-J2	704-82563-J2	905
REC704-82570-12	6E5-82570-05	905
REC704-82570-12	704-82570-08	905
REC704-82570-12	704-82570-10	905
REC704-82570-12	704-82570-11	905
REC704-82570-12	704-82570-12	905
REC84-819514T26		895
REC8542561	65W-W0093-02	873
REC866169T01	6C5-13907-00	865
REC32800-38F10	68V-81960-00	890
REC32800-38F10	6D3-81960-00	890
REC89-825096T01	6E5-81950-01	888
REC89-825096T01	6G1-81940-00	888
REC89-825096T01		884-886
REC90101-06M56	90101-06M56	1103
REC90101-06M56	97095-06030	977
REC90105-06M01	90105-06M01	1113
REC90109-08022	90109-08022	1005-1009-1013
REC90109-08262	90109-08262	913
REC90109-08M71	90109-08M71	1011
REC90119-06M10	90119-06M10	1079-1083-1085-1125-1129
REC90119-08191	90119-08191	925
REC90119-08194	90119-08194	925
REC90119-08M13	90119-08M13	1077-1107-1121
REC90119-08M14	90119-08M14	1073-1079-1083-1085-1087-1089-1091-1125-1127-1129-1130
REC90119-08M15	90119-08M15	1059-1063-1067-1071-1111
REC90119-08M21	90119-08M21	997
REC90119-08M33	90119-08M33	1073
REC90119-08M87	90119-08M87	1077
REC90149-06M00	90149-06M00	1115
REC90151-05M00	90152-05000	1073-1075
REC90170-12138	90170-012138	1115
REC90170-12138	90170-12138	1057-1061-1065-1069-1109-1111-1119
REC90170-16M01	90170-16M01	1073-1075-1079-1081-1121-1125-1127
REC90170-16M01	90170-16M01-00	1123
REC90171-10M01	90171-10M01	1047-1049-1051-1101-1144
REC90171-14013-00	90171-14013	1053-1103-1105-1107-1144
REC90171-16011	90171-16011	1057-1061-1065-1069-1073-1075-1109-1111-1115-1119-1121
REC90171-16011	90171-16011-00	1123
REC90171-16011		1079-1081-1085-1087-1089-1091-1125-1127-1129-1144
REC90171-18M04	90171-18M04	1049-1051-1099-1101
REC90179-08M06	90179-08M06	1103
REC90179-09M02	90179-09M02	1103
REC90179-10M14	90179-10M14	1053-1105-1107
REC90201-10M01	90201-10M01	1047-1144
REC90201-12565	90201-12565	991-1023
REC90201-14377	9020-14377	993-1023
REC90201-17682	90201-17682	1049-1051-1099-1101
REC90201-17M00	90201-17M00-00	1123

REF	OEM	
REC90201-20417	90201-20417	999-1001-1005-1007-1009-1103-1105-1107-1023-1024
REC90201-22429	90201-22429	1057-1061-1065-1109-1111-1115-1119-1079-1083-1085-1125-1127-1129
REC90201-23M01	90201-23M01	1011-1013-1024
REC90201-30M92	90201-30M92	1079-1081-1125-1127
REC90201-46M29	90201-46M29	993
REC90206-22M19	90206-22M19	1079-1083-1085-1125-1127-1129
REC90209-18112	90209-18112	988-989-991-1023
REC90209-20159	90209-20M23	993-1023
REC90209-22248-00	90209-22248-00	1025
REC90209-24M03	90209-24M03	995-1023-1024
REC90209-27M07	90209-27M07	999-1001-1023-1024
REC90209-27M07		1024
REC90214-48M03	90214-48M03	1115-1119
REC90250-03M10	90250-03M10	1093
REC90250-05010	90250-05010	1049-1051-1053-1099-1101-1103-1105-1107
REC90250-05036	90250-05036	1097
REC90250-05046	90250-05046	1095
REC90250-06023	90250-06023	1057-1061-1065-1069-1109-1111-1113-1115-1119
REC90250-07M02	90250-07M02	1073-1075-1121
REC90250-07M02	90250-07M02-00	1123
REC90250-08M07	90250-08M07	1079-1081-1087-1125-1127-929-930-931-932-1067-1071-1096-1097-1099-1107-1109
REC90280-03024	90280-03024	930-931-1059-1063-1073-1105-1111-1119
REC90280-03M03	90280-03M03	931-1087-1113-1117
REC90280-04002	90280-04002	930-931-932-1077-1121
REC90280-04M04	90280-04M04	1123
REC90280-04M04	90280-04M04-00	930-932-933-1079-1083-1085-1089-1125-1127-1129-1130
REC90280-05049	90280-05049	995
REC90282-04010	90282-04010	1115
REC90282-04010	90282-04010	1073-1075-1079-1103-1107-1109-1119-1121-1123-1125
REC90282-04M00	90282-04M00	1081
REC90340-08002	6E0-45316-09	1096
REC90340-08002	90304-08002	1081-1085-1087-1089-1091-1041-1043-1045-1047-1049-1050-1057-1061-1065-1069-1073-1075-1079-1095-1101-1103-1105-1107-1111-1113-1119-1121-1123-1127-1129
REC90340-08002	90340-08014	1099-1109
REC90340-08002	90340-08M04	1053-1093-1097-1125
REC90340-08002	90340-08M14	1115
REC90381-20001	90381-20001	911
REC90386-18M63	90386-18M63	911
REC90386-22M13	90386-22M13	911
REC90386-22M98	90386-22M98	911
REC90386-25M31	90386-25M31	911
REC90386-30M77	90386-30M77	911
REC90386-38M89	90386-38M89	911
REC90387-32002	90387-32002	995

REF	OEM	
REC90389-22M01	90389-22M01	1057-1061-1065-1069-1111-1115-1144
REC90389-25M00	90389-25M00	1073-1075-1121-1144
REC90430-06M03	90430-06M03	977-979-981-982-1097-1113-1115
REC90430-08020	90430-08003	1050-1061-1065-1069-1073-1075-1079-1041-1043-1045-1047-1049-1057-1081-1085-1087-1089-1091-1093-1095-1096-1097-1099-1101-1103-1105-1107-1109-1111-1113-1115-1119-1121-1125-1127-1129
REC90430-08020	93210-06ME6	1053
REC90430-08020	93430-08020	1130
REC90430-08020		848-849-850-851-852-853-854-855-856-857
REC90430-08020	90430-08020-00	1123
REC90430-12072	90430-12072	1055-1059-1063-1067-1111-1117-1121
REC90430-12072	90430-12072-00	1123
REC90480-18065	90480-18065	1001-1005
REC90480-20M05	90480-20M05	916-977-979-1009-1011-1013
REC90501-12M48	90501-12M48	1073-1075-1123
REC90501-14M02	90501-14M02	1001
REC90501-16233	90501-16233	1119-1121
REC90501-16M01	90501-16M01	1109-1115
REC90501-16M11	90501-16M11	916-977-979-1009-1011-1013-1079-1081-1125-1127
REC90501-16M37	90501-16M37	1047-1049-1101
REC91490-30025	91490-30020	1057-1061-1065-1069-1073-1107-1111-1115
REC91490-30025	91490-30025	1073-1107-1111-1115
REC91490-30025	94190-30020	848-849-851-852-853-1051-1144
REC91490-30030	91490-30030	1103-1109-1144
REC91490-30040	91490-30040	1093
REC91490-30025	91490-40025	1075-1119-1121
REC91490-30025	91490-40030	1079-1081-1085-1087-1089-1091-1125-1127-1129
REC91490-30025	91490-40030-00	852-853-854-855-856-857
REC91490-30025	91490-40030-00	1123-1144
REC93101-10M14	93101-10M14	1095
REC93101-10M25	93101-10M25	988
REC93101-11M14		1143
REC93101-11M23	93101-11M23	1047-1096
REC93101-13018	93101-13018	993
REC93101-13M11		1143
REC93101-13M12	93101-13M12	1045-1095
REC93101-13M37	9310113M3700	985
REC93101-14M01	93101-14M01	991
REC93101-15074	93101-15074	1047-1096-1097
REC93101-16001	93101-16001	995-999
REC93101-17001		1143
REC93101-17054	93101-17054	1049-1051-1099-1101
REC93101-18050	93101-18050	1097
REC93101-20048	93101-20001	1050
REC93101-20048	93101-20048	1049-1099-1101-1113
REC93101-20M07	93101-20M07	1053-1103-1105-1107
REC93101-20M10		1143
REC93101-20M29	93101-20M29	988-991
REC93101-20M34	93101-20M34	989
REC93101-22067	93101-22067	1103-1105-1109-1115-1117-1119
REC93101-22M00	93101-22067	1055

REF	OEM	
REC93101-22M00	93101-22M00	1057-1061-1065-1069-1111-1113
REC93101-22M15	93101-22M15	1011-1013
REC93101-22M60	93101-22M60	1059-1063-1111
REC93101-23070	93101-23070	1073-1107-1109-1119
REC93101-25018	93101-250-18	993
REC93101-25M03	93101-25M03	1073-1075-1077-1121
REC93101-25M03	93101-25M03-00	1123
REC93101-25M35	93101-25M28	997
REC93101-25M57	93101-25M57	1067-1071-1079-1083-1085-1087-1089-1125-1127-1129-1130
REC93101-28M16	93101-28M16	1087-1089-1079-1081-1085-1125-1127-1129
REC93101-30002	93101-300002	1001
REC93101-30M17	93101-30M17	987
REC93101-30M33	93101-30M33	989-991
REC93102-15M32	93102-15M32	999-1003
REC93102-20M25	93102-20M25	995
REC93102-23096	93102-23096	997
REC93102-25008	93102-25008	995
REC93102-25M04	93102-25M04	1143
REC93102-25M11	93102-25M11	1143
REC93102-25M28	93102-25M28	1003
REC93102-25M48	93102-25M48	993
REC93102-26M27	93102-26M27	997
REC93102-28135	93102-28135	1005
REC93102-30M05	93102-30M05	1009
REC93102-30M23	93102-30M23	1007
REC93102-30M56	93102-30M56	999
REC93102-32M07	93102-32M07	995-1005
REC93102-35M13	93102-35M13	1011-1013
REC93102-35M18	93102-35M18	1001
REC93102-36M02	93102-36M02	1009
REC93102-36M24	93102-36M24	1007
REC93102-38008	93102-38008	979
REC93102-38008	93102-38M59	977-979
REC93102-40M38	93102-40M14	1011-1013
REC93103-10052	93103-10052	1093
REC93103-11051	93103-11051	1093
REC93104-16M01	93104-16M01	1001-1003
REC93104-16M01	93104-16M04	997
REC93104-18049	93104-18049	1005
REC93104-20M02	93104-20M02	1009
REC93104-22M07	93104-22M07	1087
REC93106-09014	93106-09014	1063-1067-1071-1073-1077-1079-1083-1085-1087-1089-1119-1121-1125-1127-1129
REC93106-09014	93106-09014-00	1123
REC93106-18M01	93106-18M01	1007
REC93109-44M00	93109-44M00	910
REC93110-23M00	93110-23M00	993
REC93210-06ME6	93210-06ME6	1047-1049-1051-1055-1059-1101-1111
REC93210-07540	93210-07003	1083
REC93210-22M02	93210-22M02	1001
REC93210-32738		849-850-852-853
REC93210-33MG4	93210-33MG4	1059-1063-1067-1071-1111-1079-1083-1085-1087-1089-1091-1125-1127
REC93210-37M67	93210-37160	1085-1087-1089-1091-1125-1127
REC93210-37M67	93210-37M67	1129-1130
REC93210-41042	93210-41042	1107-1109-1117-1119
REC93210-42101	93210-42101	1093
REC93210-42159	93210-42159	989-991-997-1005
REC93210-42M70	93210-42M70	991
REC93210-44398	93210-44398	1047-1049-929-931
REC93210-45161		931
REC93210-46044	93210-46044	1073-1077-1121
REC93210-46044	93210-46044-00	1123

REF	OEM	
REC93210-46M16	93210-46M16	993-995-1007-1009
REC93210-48214	93210-48214	1045-1091-1095
REC93210-48MG8	93210-48MG8	1059-1067-1111
REC93210-49046	93210-49046	1047-1051-1073-1077-1096-1109-1119-1121-929
REC93210-49046	93210-49046-00	1123
REC93210-53M08	93210-53M08	1047-1096
REC93210-54M54	93210-54M54	989
REC93210-57M00	93210-57M00	1113
REC93210-57M09	93210-57M09	1049-1051-1099-1101-1079-1083-1125-1127
REC93210-58677	93210-58144	1097
REC93210-58677	93210-58677	1097
REC93210-57M09	93210-58M21	995-1003
REC93210-59MG7	93210-59MG7	1059-1063-1067-1071-1111-930-931
REC93210-60MA3	93210-60MA3	1107
REC93210-62269	93210-62269	1005-1009
REC93210-64ME7	93210-64ME7	1053-1105
REC93210-65752-00	93210-64488	1085-1087
REC93210-65M50	93210-65M50	999-1001-1007-1053-1105
REC93210-66M98	93210-66M98	1109-1115-1119
REC93210-69MG6	93210-69MG6	1057-1061-1065-1069-1091-1111-1011-1013
REC93210-74M35	93210-74M35	1057-1061-1065-1069-1111
REC93210-74MG5	93210-74MG5	1121
REC93210-85M97	93210-85M97	1123
REC93210-85M97	93210-85M97-00	930-932-933-1079-1083-1085-1089-1125-1127-1129-1130
REC93210-86M38	93210-86M38	1073-1075-1079-1125
REC93210-86M39	93210-86M39	1079-1091
REC93210-94003	93210-94003	1081-1127
REC93210-97M55	93210-97M55	1011-1013
REC93211-04001	93211-04001	1021
REC93304-205U0		1057-1061-1065-1069-1111-1139-1140
REC93306-001U1	93306-001U1	1049-1051-1099-1101-1137-1138
REC93306-00501	93306-00501	1097-1137
REC93306-00519	93306-00519	1103-1105-1107-1138-1139
REC93306-00612	93306-00612	1109-1115-1119-1138-1139-1140
REC93306-00702	93306-00702	988-989-991-1020-1021
REC93306-204U0	93306-204U0	1113
REC93306-204Y7	93306-20401	1021
REC93306-205U2		993-1021
REC93306-205U7	93306-205U7	1021
REC93306-206U4		1009-1022
REC93306-206U5	93306-206U5	1073-1075-1121-1139-1140-1141
REC93306-207U0	93306-207U0	1140-1141
REC93306-207U0	93306-207U0-00	1123
REC93306-208U0	93306-208U0	1011-1013-1079-1125-1022-1023-1141
REC93306-209U0	93306-209U0	1081-1087-1127-1141-1142-1143
REC93306-304U0		1020-1021
REC93306-305U3	93306-305U3	1021
REC93306-305U8	93306-305-U8	995-997-1021
REC93306-306V1	93306-303V1	1003-1021
REC93306-306V5	9306-306V5	1001-1007-1021-1022
REC93306-307U0	93306-307U0	999-1021
REC93310-112V0	93310-112V0	999-1001-1021-1022
REC93310-32337	93310-32337	988-989-1026-1020-1021
REC93310-32337	93310-32337	1013-1028-1030
REC93310-32337	93603-21111	1011
REC93310-32337		1029
REC93310-32337		1022-1023

REF	OEM	
REC93310-418U0	93310-418U0	991-1021
REC93310-418U1	93310-418U1	1025
REC93310-418V1	93310-418V1	988-989-1020-1021
REC93310-522W0		1021
REC93310-527W1		1022
REC93310-620V5	93310-620V5	993-1021
REC93310-624U5	93310-62406	995-1021
REC93310-636U4	93310-636U4	1009-1022
REC93310-727U0	93310-727U0	999-1021
REC93310-727V7	93310-727V7	1001-1021
REC93310-730V6		1021
REC93310-730V8	93310-730V8	1005-1009-1022
REC93310-835U8	93310-835U8	1009-1022
REC93310-836V2	93310-836V2	1011-1013-1022-1023
REC93310-954U1	93310-954U1	1011-1013-1022-1023
REC93310-954U1		1022-1023
REC93311-632U1	93311-632U1	1005-1021
REC93311-632U7	93311-632U7	997-1021
REC93311-632V4		1021
REC93311-636U6	93311-636U6	1007-1021-1022
REC93311-83280	93311-83280	1085-1087-1089-1129-1142-1143
REC93311-85894	93311-85894	1087
REC93311-928U5	93311-928U5	1083-1127-1141-1142-1143
REC93311-940U3	93311-940U3	1011-1013-1022-1023
REC93315-017U4	93315-017U4	1103-1138-1139
REC93315-217U0	93315-217U0	1113-1139
REC93315-22004	93315-22004	1053-1103-1055-1107-1138-1139
REC93315-220V7	93315-220V7	1105-1107-1138-1139
REC93315-314V8	93315-314V8	1049-1050-1101-1137-1138
REC93315-317U2	93315-317U2	1049-1051-1099-1101-1137-1138
REC93315-32224	93315-32224	1059-1063-1067-1071-1109-1111-1117-1119-1138-1139-1140
REC93315-324U1	93315-324U1	1113-1139
REC93315-325V1	93315-325V1	1121-1138-1139-1140-1141
REC93315-325V1	93315-325V1-00	1123
REC93315-425U7	93315-425U7	1079-1125-1141
REC93315-425V3	93315-425V3	1081-1127-1141-1142-1143
REC93315-43061	93315-43061	1081-1085-1087-1127-1129-1141-1142-1143
REC93315-43064	93315-43064	1089
REC93315-43061	93315-430U8	1079-1125-1141-1142-1143
REC93315-430V5		1143-1141-1142
REC93315-628U9	93315-628U9	1079-1125-1141-1142
REC93317-22204	93317-22204	1057-1061-1065-1069-1109-1111-1115-1119-1138-1139-1140
REC93317-322V0	93317-322V0	1073-1075-1140-1141
REC93317-325U0	93317-325U0	1073-1075-1121
REC93317-325U0	93317-325U0-00	1123
REC93317-325U0		1140-1141
REC93315-430V5	93317-330U2	1079-1083-1085-1089-1125-1127-1129-1141-1142-1143-1141
REC93332-00001	93332-00001	1059-1063-1067-1071-1107-1111-1119-1138-1139-1140
REC93332-00003	93332-00003	1057-1061-1065-1111-1115-1119-1139-1140
REC93332-00005	93332-00005	1049-1051-1053-1099-1101-1103-1105-1137-1138-1139

POLÍTICA DE GARANTÍA RECMAR

Todos los productos comercializados por **RECMAR** deben ser instalados y utilizados por personal competente bajo su exclusiva responsabilidad. **RECMAR** no se responsabiliza de las consecuencias producidas por una instalación defectuosa o inapropiada de ningún artículo que no incluya soluciones de instalación.

El instalador será el responsable de verificar la correcta aplicación de las recomendaciones del fabricante en cuanto a compatibilidades de uso.

Los artículos comercializados por **RECMAR** están amparados por la garantía legal.

RECMAR distribuye los artículos presentes en sus catálogos únicamente a profesionales, nunca a particulares o cliente final, el importe de la instalación jamás estará incluido en el precio por lo que no será responsable de ésta.

Los artículos comercializados por **RECMAR** disponen de una garantía limitada por defectos de fabricación, los periodos pueden variar entre los 3 años y los 3 meses, descartando los artículos considerados como consumibles: productos eléctricos, baterías y otros que carecen de periodo alguno, si necesita conocer el plazo exacto del producto contacte con el departamento comercial.

El material que enviamos diariamente desde **RECMAR** a nuestros clientes es examinado antes de empaquetarse para su perfecta integridad y evitar daños en el transporte. Recuerde que es muy importante inspeccionar las cargas en presencia del transportista. Cuando se observen daños en la caja, deberá incluirse en el albarán de entrega del transportista una mención del tipo (CONFORME MERCANCÍA, SALVO INSPECCIÓN), y deberá ser firmada por usted y el transportista. En caso de recibir material defectuoso por estas causas debe hacerlo constar tanto al transportista como a **RECMAR** para poder reclamar a la empresa de transporte correspondiente.

SOLICITUD DE GARANTÍA

La garantía siempre estará sujeta a la valoración final del departamento técnico de **RECMAR**. Esta valoración se llevará a cabo en nuestras instalaciones o en caso necesario por el fabricante del artículo, en ambas opciones el artículo tiene que estar físicamente en nuestras instalaciones centrales de Viladecans. El tiempo para la resolución será un máximo de 30 días naturales desde su recepción.

Para enviar el artículo defectuoso, debe ir a la página web www.recambiosmarinos.es, o www.usarecmar.com ir a su cuenta y seleccionar TRAMITAR GARANTÍA dentro del área privada, desde aquí podrá descargar el archivo para la solicitud de garantías de motores y piezas, y seguir las instrucciones.

RECMAR no asumirá ningún préstamo de reemplazo durante el proceso de garantía.

EXCLUSIONES DE GARANTÍA

RECMAR no podrá ser acusado como responsable del defecto ante:

- Desgaste normal del producto.
- Defectos de instalación o uso inadecuado.
- Instalación de un artículo no destinado a ese modelo.
- Daños por causa externa (accidente, rayo, fluctuación de corriente...)
- Defectos y consecuencias relacionadas con el transporte.
- Alteraciones en instalaciones o barcos destinados a la competición.

En caso de rechazo de la garantía, el cliente tiene la posibilidad de recuperar su artículo defectuoso poniéndose en contacto con nosotros vía e-mail solicitando la devolución del mismo dentro de los 7 días naturales siguientes a la fecha en que se le informó del rechazo de garantía.

RECMAR no forma parte de las garantías comerciales anunciadas en ocasiones por los fabricantes.

RECMAR WARRANTY POLICY

All products sold by **RECMAR** must be installed and used by competent personnel under their exclusive responsibility. **RECMAR** shall not be responsible for the consequences of the faulty or improper installation of any item that does not include installation solutions.

The fitter will be responsible for checking that the manufacturer recommendations have been followed correctly in terms of compatible uses.

Articles sold by **RECMAR** are covered by legal warranty.

RECMAR distribute the products only to professionals and never to private final clients. The cost of installing the part would never be included in the price for which reason, **RECMAR** would never be responsible for its installation.

Articles sold by **RECMAR** are covered by warranty for manufacturing defects for a limited period of time that may vary between 3 years and 3 months, except for the articles considered consumable, electrical products, batteries and others that are not covered at all. For information on the exact warranty period of an article, please contact the Sales Department.

The goods that **RECMAR** sends every day to its customers are examined before being packed to ensure their perfect integrity and avoid damage during shipping. Remember that it is essential to check the goods in the presence of the dispatcher. If the package is damaged, the dispatcher's delivery note must mention what type (CONFORMING GOODS, UNLESS INSPECTED), and must be signed by you and by the dispatcher. If you receive damaged goods for these reasons you must notify both the dispatcher and **RECMAR** to be able to make the claim to the relevant delivery company.

WARRANTY CLAIMS

Warranties are always subject to **RECMAR** Technical Department's assessment. The assessment will be carried out on **RECMAR**'s premises or, if necessary, by the article's manufacturer. In both cases, the article must be physically on **RECMAR**'s premises in Viladecans. Assessment time will not exceed 30 calendar days from receiving the article.

To return the faulty item, visit www.recambiosmarinos.es, or www.usarecmar.com, go to your account and select PROCESS WARRANTY in the private section. From there you will be able to download the file to claim the warranty of engines and parts and follow the instructions.

RECMAR will not charge for the loan of the replacement during the warranty process.

WARRANTY EXCLUSIONS

RECMAR shall not be responsible for product faults in the following cases:

- Normal wear and tear of a product.
- Installation faults or improper use.
- Installation of an article not designed for the model in question.
- Damage due to external causes (accidents, lightning, power surges...)
- Defects and consequences of transport.
- Alterations to installations or to boats intended for competitions.

If the warranty is refused, the customer may retrieve the faulty article by contacting **RECMAR** via email and requesting that the article is returned to them within 7 calendar days from the day the warranty was refused.

RECMAR does not apply the warranties offered from time to time by manufacturers.

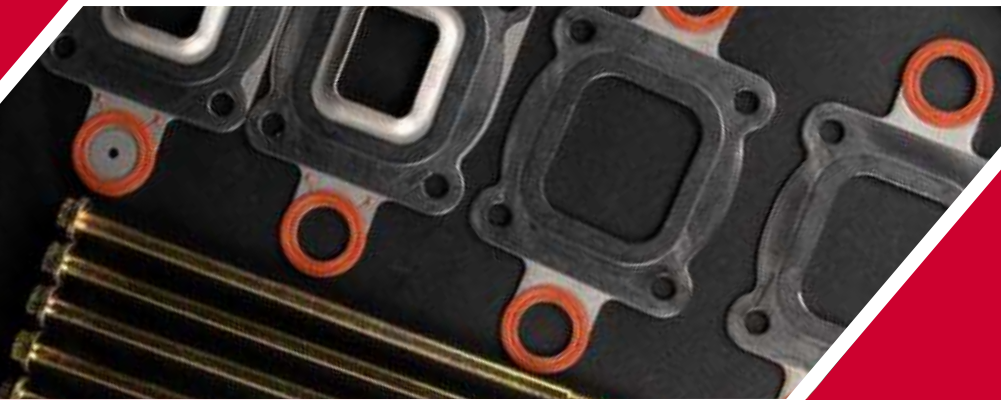
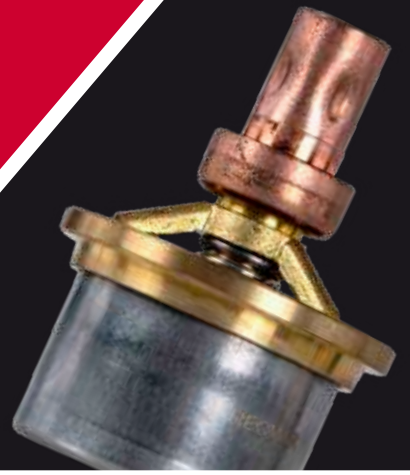

RECMAR
USA

1917 NW 79 Ave
Miami, FL 33126

Ph. 786-962-5020

info@usarecmar.com

www.usarecmar.com

RECMAR[®]

Jocelyn Bell, 26
08840 Viladecans
Barcelona

phone: (+34) 93 662 66 55

info@recambiosmarinos.es
www.recambiosmarinos.es

www.recmar.es