















RECMAR[®]





HIGH QUALITY MARINE PARTS







FOR **OMC**



ICONOS ICONS

	Medida	Measures
	Peso	Weight
	Material	Material
	Flujo Velocidad	Flow Speed
	Presión	Pressure
	Temperatura	Temperature
	Electricidad	Power
	Unidades x bolsa	Units x bag
	Unidades x skinpack	Units x skinpack
	Tornillo	Screw
	Tubo Manguera	Tube
	Rosca	Thread
	Rosca Macho	Male Thread
	Entrada	IN
	Salida	OUT

	Filtro	Filter
	Elemento filtro	Filter Element
	Junta	Gasket
	Llave	Key
	Posiciones llave	Key positions
	Mando	Control
	Pins	Pins
	Cables Terminales	Terminals
	Cable	Cable
	Piston	Piston
	Aros de piston	Piston ring
	Cojinete	Bearing
	Bulón	Pin
	Biela	Connecting rod
	Clip	Clip

	Impulsor	Impeller
	Dientes	Tooth
	Aguja carburador	Carburetor needle
	Flotador carburador	Carburetor float
	Abrazadera	Clamp
	Volante motor	Flywheel
	Estrias	Spline
	Polea	Pulley
	Solenide Relé	Solenoid Relay
	Motor	Motor

IMPORTANTE

LOS PRODUCTOS QUE APARECEN EN NUESTROS CATALOGOS SON VÁLIDOS Y COMPATIBLES CON LOS MOTORES Y TRANSMISIONES DE LAS MARCAS ORIGINALES QUE APARECEN EN CADA SECCIÓN. ESTA INFORMACIÓN APARECE CON LA REFERENCIA EN EL MOMENTO DE CONFIRMAR EL PEDIDO POR NUESTRA WEB.

LA IMÁGENES AQUÍ CONTENIDAS PUEDEN NO CORRESPONDER CON TOTAL PRECISIÓN AL PRODUCTO SUMINISTRADO. RECAMBIOS MARINOS, S.L.U. SE RESERVA EL DERECHO DE ANULAR O CAMBIAR PRODUCTOS SIN PREVIO AVISO.

IMPORTANT

THE PRODUCTS THAT APPEAR IN OUR CATALOGS ARE VALID AND COMPATIBLE WITH THE MOTORS AND TRANSMISSIONS OF THE ORIGINAL BRANDS THAT APPEAR IN EACH SECTION. THIS INFORMATION APPEARS WITH THE REFERENCE AT THE TIME OF CONFIRMING THE ORDER BY OUR WEB.

IMAGES CONTAINED HERE MAY NOT CORRESPOND WITH TOTAL ACCURACY TO THE PRODUCT SUPPLIED. RECAMBIOS MARINOS, S.L.U. RESERVES THE RIGHT TO CANCEL OR CHANGE PRODUCTS WITHOUT PRIOR NOTICE.

COOLING SYSTEM	515	EXHAUST & INTAKE SYSTEM	529	STEERING SYSTEM	509
THERMOSTAT	515	BLOCK CIRCULATING PUMP	534	ENGINE CONTROLS	509
THERMOSTAT GUIDE	515	PUMPS	534	SIDE CONTROL	509
THERMOSTAT KITS	515	HOSE	534		
THERMOSTATO HOUSING	515	MANIFOLDS & ELBOWS PARTS	529	TRANSMISSION UNIT	535
WATER PUMP	516	120 HP	529	ANODE	535
WATER PUMP SERVICE KITS	516	140 HP	530	GASKETS	546
		4.3 GM	531	OUTDRIVE SEAL COBRA	546
ELECTRIC SYSTEM	510	800 GM	532	SWIVEL BRG. MECH SHIFT	546
		5.7 GM	532	WATER OUTLET	546
ALTERNATORS	512	5.0 / 5.8 GM	533	GEAR CASE PARTS	536
ALTERNATORS	512	7.4 / 8.2 GM	533	400-800 (1973-85)	542
SENSORS	510	ELBOW GASKET	534	COBRA (1986-93)	536
COMPLETE TEMPERATURE & OIL PRESSURE	510	EXHAUST MANIFOLD GASKET	534	COBRA (1994-98)	540
WARNING KIT	510	RUBBER CAP	534	TRANSOM	544
MAP SENSOR	510			GEARHOUSING COMPONENTS	549
OIL PRESSURE SENDER	510	FUEL & FILTRATION SYSTEM	506	DRIVES SHAFTS	549
TPS SENDER	510			EXHAUST BELLOWS	549
WATER TEMPERATURE SENDER	510	CARBURETORS	507	PROP SHAFT MECHANICAL SHIFT	549
SOLENOID & RELAY	513	BASE GASKETS	508	U-JOINTS	549
RELAY FOR FUEL ELECTRIC PUMP	513	CARBURETORS KITS	507	REPAIR KITS	546
SOLENOID	513	GUIDE CARBURETORS KIT	509	DRIVES	546
STARTERS	511	ELECTRICAL FUEL PUMP	506	WATER PUMP SHAFT	546
TRIM	513	FUEL FILTERS AND ELEMENTS	506	SEALS	547
TRIM ENGINES	513	FUEL FILTER	506	COBRA SEALS APPLICATIONS	548
TRIM HOSES COBRA	514	MECHANICAL FUEL PUMP	507	OIL SEAL GUIDE	547
TRIM SENSOR COBRA	514	OIL FILTER	506	O'RING GUIDE	547
ENGINE PARTS	520	IGNITION SYSTEM	517	STERNDRIVES TOOLS	549
				V-BELTS GUIDE	548
MARINE GASKETS TO GM & FORD ENGINES	520	HARNESS	519	OEM --> REF	551
100, 110, 120 HP	520	COILS	517	REF --> OEM	553
115, 130, 140 HP	521	IGNITION COIL	517		
150, 160, 175, 180, 205 HP	521	IGNITION COIL GUIDE	517		
170, 185, 190, 200 HP	522	DISTRIBUTOR	518		
225, 230 HP	523	DISTRIBUTOR CAPS	518		
210, 215, 235, 245 HP	524	ROTORS	519		
220, 250, 260, 270, 290 HP	525	IGNITION MODULES	518		
240 HP	524	SPARK PLUG	518		
330, 335 HP	526	HD SPARK PLUG WIRE SET	518		
375 HP	527				
351 W	528				

ES

SISTEMA DE ALIMENTACIÓN Y FILTRACIÓN	506	SISTEMA DE REFRIGERACIÓN	515	UNIDADES DE TRANSMISIÓN	535
BOMBA DE COMBUSTIBLE ELÉCTRICA	506	TERMOSTATO	515	ÁNODO	535
BOMBA DE COMBUSTIBLE MECÁNICA	507	CUERPO DE TERMOSTATO	515	CIERRE DE HÉLICE	550
CARBURADORES	507	GUIA TERMOSTATOS	515	COMPONENTES DE COLA	549
GUÍA KIT CARBURADORES	509	KITS DE TERMOSTATO	515	CRUCETAS CARDAN	549
JUNTAS BASE	508	BOMBA DE AGUA	516	EJE HÉLICE CAMBIO MECÁNICO	549
KITS DE CARBURADOR	507	KITS DE REPARACIÓN BOMBA DE AGUA	516	EJES TRANSMISIÓN	549
FILTRO DE ACEITE	506			FUELLES ESCAPE	549
FILTRO DE COMBUSTIBLE Y ELEMENTOS	506	PARTES DEL MOTOR	520	DESPIECE COLAS	536
FILTRO GASOLINA	506			400-800 (1973-85)	542
SISTEMA ELÉCTRICO	510	JUNTAS PARA BASES GM Y FORD	520	COBRA (1986-93)	536
ALTERNADORES	512	100, 110, 120 HP	520	COBRA (1994-98)	540
ALTERNADORES	512	115, 130, 140 HP	521	TRANSOM	544
MOTORES DE ARRANQUE	511	150, 160, 175, 180, 205 HP	521	GUÍA CORREAS	548
SENSORES	510	170, 185, 190, 200 HP	522	HERRAMIENTAS COLAS	549
KIT TEMPERATURA Y PRESIÓN DE ACEITE CON ALARMA	510	225, 230 HP	523	JUNTAS	546
SENSOR MAP	510	210, 215, 235, 245 HP	524	CAMBIO MECÁNICO	546
SENSOR PRESIÓN DE ACEITE	510	220, 250, 260, 270, 290 HP	525	CIERRE COBRA	546
SENSOR TEMPERATURA AGUA	510	240 HP	524	SALIDA AGUA	546
SENSOR TPS	510	330, 335 HP	526	KITS REPARACIÓN	546
SOLENOIDES Y RELÉS	513	375 HP	527	COLAS	546
SOLENOIDE	513	351 W	528	EJES BOMBA AGUA	546
RELÉ BOMBA DE GASOLINA ELÉCTRICA	513	SISTEMA DE ESCAPE Y ADMISIÓN	529	RETENES	547
TRIM	513			APLICACIÓN DE RETENES COBRA	548
LATIGUILLOS TRIM COBRA	514	BOMBA DE CIRCULACIÓN BLOQUE	534	GUÍA AROS TÓTICOS	547
MOTOR TRIM	513	BOMBAS	534	GUÍA RETENES ACEITE	547
SENSOR TRIM COBRA	514	MANGUITO	534	SISTEMA DE GOBIERNO	509
SISTEMA ENCENDIDO	517	DESPIECES COLECTORES Y CODOS	529	MANDOS DE CONTROL	509
ARNES	519	120 HP	529	MANDO LATERAL	509
BOBINAS	517	140 HP	530	OEM --> REF	551
BOBINA DE ENCENDIDO	517	4.3 GM	531	REF --> OEM	553
GUÍA BOBINA DE ENCENDIDO	517	800 GM	532		
BUJÍAS	518	5.7 GM	532		
JUEGOS DE CABLES, ALTO RENDIMIENTO	518	5.0 / 5.8 GM	533		
DISTRIBUIDOR	518	7.4 / 8.2 GM	533		
ROTORES	519	JUNTAS CODOS	534		
TAPA DISTRIBUIDOR	518	JUNTA COLECTOR DE ESCAPE	534		
MÓDULOS IGNICIÓN	518	TAPÓN DE GOMA	534		

SISTEMA DE ALIMENTACIÓN Y FILTRACIÓN FUEL & FILTRATION SYSTEM

MORE FILTERS
13

FILTRO DE COMBUSTIBLE Y ELEMENTOS

FUEL FILTERS AND ELEMENTS

FILTRO GASOLINA

FUEL FILTER

REF	OEM
REC35-49088A2	312456 381690



FILTRO DE ACEITE

OIL FILTER

REF	OEM	
REC35-06003	778864	4L GM



REF	OEM	
REC35-06004	173834 502903	V6 GM



REF	OEM	
REC35-06007	502900	2.3L, V8, 302, 351



REF	OEM	
REC3517857	174796 502904	Ford 7.5L / 460



FILTRO DE GASOLINA CARBURADOR

CARBURETOR FUEL FILTER





REF	OEM	CARB.
REC984491	802416	Rochester



BOMBA COMBUSTIBLE ELÉCTRICA

ELECTRICAL FUEL PUMP

REF	OEM		
REC3858261	3858261 3857986 3854620	432, 434, 502, 52 43f, 50f, 57f	8 PSI



OMC

BOMBA COMBUSTIBLE MECÁNICA

MECHANICAL FUEL PUMP

REF	OEM	
REC3855276	981650	GM V8, 305, 307, 350

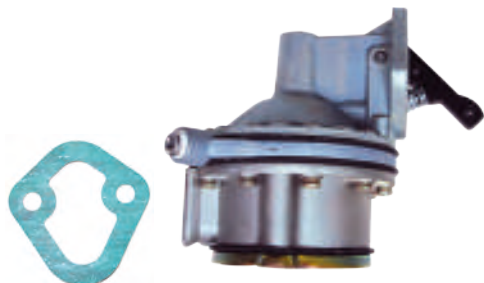

REF	OEM
REC86234A4	985603 982240 985602



REF	OEM	
REC62092T	982063	FORD V8, 302



REF	OEM
REC982997	982997



CARBURADORES

CARBURETORS

REF	OEM	
REC1347-816373A4	981705	ROCHESTER 4 BB
	982223	
	983855	
	981359	
	982215	
	981564	
	985822	
	981803 981428	

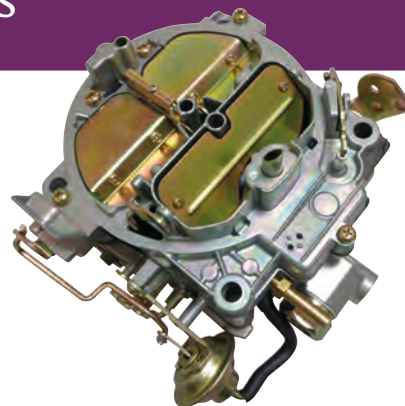

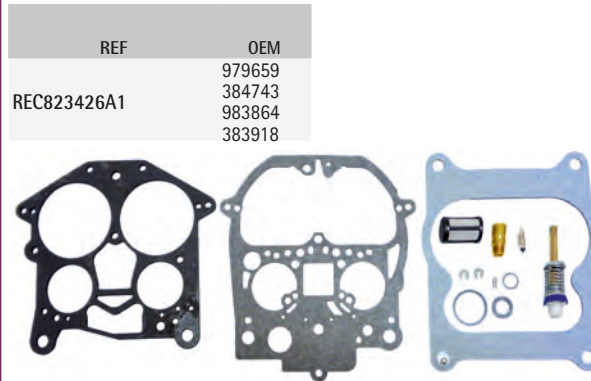
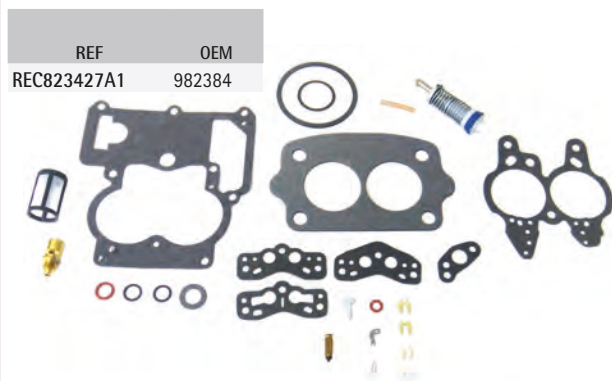

KITS DE CARBURADOR

CARBURETORS KITS



GUÍA KIT CARBURADORES

GUIDE CARBURETORS KIT

		COD.	MOD.	KIT			COD.	MOD.	KIT
80	1968-69	R2	2GC	REC823427A1	2.3 L	1987-89	R2	2GE	REC841994
90	1970-71	R2	2GC	REC823427A1	2.5L	1986-90	R2	2GE	REC841994
140	1973-85	R2	2GC	REC823427A1	2.5L	1986	R2	2GC	REC823427A1
165	1972-76	R2	2GC	REC823427A1	3.0L	1982-90	R2	2GC	REC823427A1
170	1974	H2	2300	REC1396-4656	3.0L/HO	1991-92	H2	2300	REC21533394
175	1975-77	H2	2300	REC1396-4656	3.8L	1979-85	R2	2GE	REC841994
185	1978-81	R2	2GE	REC841994	4.3L	1986-89	R2	2GE	REC841994
185	1989	H2	2300	REC1396-4656	4.3L	1979-89	R4	4MV	REC823426A1
190	1974-77	H2	2300	REC1396-4656	4.3/262	1989	R2	2GE	REC841994
200	1979-85	R2	2GE	REC841994	4.3 HO	1990-92	H2	2300	REC3854020
200	1989	H2	2300	REC1396-4656	5.0L (GM)	1979-85	R2	2GE	REC841994
210	1968-72	R4	4MV	REC823426A1	5.0L (GM)	1979-89	R4	4MV	REC823426A1
215	1971	R4	4MV	REC823426A1	5.0L (Ford)	1989	H2	2300	REC1396-4656
225	1972-76	R4	4MV	REC823426A1	5.0 HO	1991	H4	4160	REC1396-5238
230	1975-76	R4	4MV	REC823426A1	5.7L	1979-89	R4	4MV	REC823426A1
230	1979-89	R4	4MV	REC823426A1	305 C.I.I./B	1977-79	R2	2GE	REC841994
235	1975-77	H4	4160	REC1396-5238	305 C.I.I./B	1977-78	R4	4MV	REC823426A1
245	1972-75	R4	4MV	REC823426A1	305 C.I.I./B	1979-83	R4	4MV	REC823426A1
250	1970-74	R4	4MV	REC823426A1	305 C.I.I./B	1979-83	R4	4MV	REC823426A1
260	1975-76	R4	4MV	REC823426A1	350	1988-89	R4	4MV	REC823426A1
260	1979-89	R4	4MV	REC823426A1	350	1988	R2	2GE	REC841994
290 JET	1974-75	R4	4MV	REC823426A1	454 C.I.I./B	1977-78	R4	4MV	REC823426A1

SISTEMA DE GOBIERNO

STEERING SYSTEM

MANDOS DE CONTROL

ENGINE CONTROLS

MANDO LATERAL

SIDE CONTROL

REF	OEM	TRIM
REC5006561	5006561	✓



SENSORES

SENSORS

SENSOR PRESIÓN DE ACEITE

OIL PRESSURE SENDER

REF	OEM	
REC8M0068784	3857532	80 PSI



SENSOR TEMPERATURA AGUA

WATER TEMPERATURE SENDER

REF	OEM
REC3854159	3854159



REF	OEM	
REC806490T	3853787	3/8" 18NPT



REF	OEM	
REC97258A1	171960	1/2" 14NPT



KIT TEMPERATURA Y PRESIÓN DE ACEITE CON ALARMA

COMPLETE TEMPERATURE & OIL PRESSURE WARNING KIT

REF
REC41400

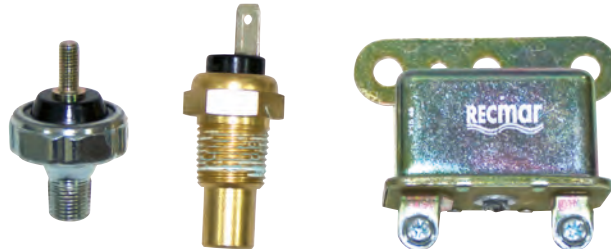

SENSOR TPS

TPS SENDER

REF	OEM
REC8M0125617	3855184



VACUÓMETRO. MAP

MAP SENSOR

REF	OEM
REC3850396	3850396





MOTORES DE ARRANQUE



STARTERS

REF	OEM			
REC50-99417A2	982121 981078 988217	12V	9	4 en línea (Tornillos sujeción misma altura) Duty standard rotation 4 in line. In line mounting holes.



REF	OEM				
REC0984628	984628	12V	10		FORD 2.3L & 5.8L Con 3 tornillos de anclaje. 3 mounting holes.





REF	OEM				
REC0984536	984536 988013	12V	10		OMC 460 COBRA





REF	OEM			
REC0987883	3854194			Solenoid Solenoid





REF	OEM			
REC50-97499A2	981289 982202	12V	9	1.4 kW





REF	OEM				
REC50-808011A05	981288 984982	12V	9		Contrarrotación o montaje en campana. Counter clockwise starter .







REF	OEM				
RECRA122002	0980803, 0987969	12V	10		Contrarrotación. Counter clockwise starter

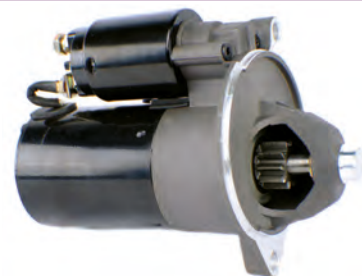

REF	OEM			
REC3854190	987811 3854190	12V	10	Ford 5.0L Et 5.8L Con 2 tornillos de anclaje 2 mounting holes



REF	OEM				
REC50-863007A1	3860566	12V 1.4 kW	11	14"	V6 Et V8





	OEM
REC10-861788	10-861788



REF	OEM			
REC50-99418A2	3860566	12V	9	Tornillos sujeción en diagonal Offset mounting holes

	OEM
MP0180-001	10-812509184
REC10-861788	10-861788



REF	OEM				
REC50-806965A4	988217	12V	11	12 ^{3/4} "	COBRA 3.0 L

	OEM
MP0180-001	10-812509184
REC10-861788	10-861788



REF	OEM				
REC3885317	3860566	12V	11	HEAVY DUTY. GM 454 7.4L	Tornillos sujeción en diagonal Offset mounting holes

	OEM
REC10-861788	10-861788



ALTERNADORES

ALTERNATORS

ALTERNADORES

REF	OEM	
REC69729	988247	12V 63 A



ALTERNATORS

REF	OEM	
REC3860769	986008 985964	12V 55 A



SOLENOIDES Y RELÉS

SOLENOID & RELAY

SOLENOIDE

REF	OEM
REC13037	1114356 DELCO REMY



SOLENOID

REF	OEM
REC0586180	383622 582708 345419 586180



REF	OEM
REC3853839	982187 985063



RELÉ BOMBA DE GASOLINA ELÉCTRICA

RELAY FOR FUEL ELECTRIC PUMP

REF	OEM
REC3857533	3857533



TRIM

MOTOR TRIM

TRIM ENGINES

REF	OEM	✂
REC0393988	393259	2
	393988	
	394176	
	391264	
	983019	
	985237	



REF	OEM	✂
REC382138	986280 3853945	2



REF	OEM	✂
REC0584107	387277 582048 582155	3



REF	OEM	✂	🔧
REC3853945	986280 3853945	2	COBRA (1987-93)



REF	OEM	
REC0982706	982058 982706	3



LATIGUILLOS TRIM COBRA

ESTRIBOR - BAJADA

STB - DOWN

REF	OEM
REC3853854	3853854



TRIM HOSES COBRA

BABOR - BAJADA

PORT - DOWN

REF	OEM
REC3853856	3853856



ESTRIBOR - SUBIDA

STB - UP

REF	OEM
REC3853855	3853855



BABOR - SUBIDA

PORT - UP

REF	OEM
REC3853857	3853857



SENSOR TRIM COBRA

REF	OEM
RM3850470	3850470 0983939 0984731





TRIM SENSOR COBRA

TERMOSTATO

THERMOSTAT

KITS DE TERMOSTATO

THERMOSTAT KITS

REF	OEM		
REC3853799	3853799	Chevys 4 cil. (1980+)	160 °C



REF	OEM		
REC3853983	3853983	7.4L (1994-97)	140°





3852111 3852071 3853983

REF	OEM	
REC13430	N000 Chevys 4 cyl. (1980+)	



GUIA TERMOSTATOS

THERMOSTAT GUIDE

	TERMOSTATO THERMOSTAT	KIT		TERMOSTATO THERMOSTAT	KIT		TERMOSTATO THERMOSTAT	KIT
90	1970	REC13430	200	1979-81	REC13430	305	1977-82	REC13430
100	1972-73	REC13430	210	1969-72	REC13430	350	1977-82	REC13430
120	1969-80	REC13430	215	1971	REC13430	454	1977-82	REC13430
120	1980-81	REC3853799	225	1971	REC13430	2.5L	1982-88	REC3853799
140	1973-80	REC13430	230	1979-81	REC13430	3.0L	1982-88	REC3853799
140	1980-81	REC3853799	235	1971	REC13430	3.8L	1981-85	REC13430
155	1969-72	REC13430	235	1975-77	REC13430	4.3L	1985-86	REC13430
165	1972-76	REC13430	240	1978	REC13430	5.0L	1982-88	REC13430
170	1974	REC13430	245	1972-75	REC13430	5.7L	1982-88	REC13430
175	1975-77	REC13430	250	1970-73	REC13430	7.4L	1994-97	REC3853983
185	1978-80	REC13430	250	1979	REC13430	7.5L	1988	REC13430
190	1974-77	REC13430	260	1979-81	REC13430			

CUERPO DE TERMOSTATO

THERMOSTAT HOUSING

REF	OEM	
REC3850360	986292 987716 3850360	V6 Et V8



BOMBA DE AGUA

WATER PUMP

TAPA DE LA BOMBA

PUMP COVER

REF	OEM
REC313176	313176



GRUESO

GROMMET

REF	OEM
REC305762	0305762
	0320936
	0396355
	305762



TORNILLO TAPA SELECTOR

SCREW

REF	OEM
REC304027	304027



TORNILLO TRANSMISIÓN

TRANSMISSION SCREW

REF	OEM
REC305282	0305282,
	305282



TORNILLO TAPA

COVER SCREW

REF	OEM
REC3852568	0769674,
	0911859,
	3852568,
	911859



KITS DE REPARACIÓN BOMBA DE AGUA

WATER PUMP SERVICE KITS

REF	OEM
REC879031	0983218
	983218



REF
REC12092



BOBINAS

COILS

BOBINA DE ENCENDIDO

IGNITION COIL

REF	OEM
REC300-00879	3852217

No usa resistencia externa.
Utilizar con encendido Prestolite.
Use without external resistor & Prestolite ignition



REF	OEM	Icon
REC3854161	3854161	FORD



REF	OEM	Icon
REC3854002	3854002	GM



REF	OEM
REC1463-9382	3853548

Resistencia externa.
Utilizar con encendido convencional.
External resistor. Use with conventional ignition



GUÍA DE BOBINAS DE ENCENDIDO

IGNITION COIL GUIDE

	Icon	REF
94-93	🔧	351 EFI King REC3854161
		5.0L, 5.8L EFI REC3854161
94-90	🔧	3.0L, 3.0L H.O. REC3854002
		5.0L, 5.0L H.O., 5.8L REC1463-9382
94-89	🔧	5.7L REC1463-9382
		7.4L REC1463-9382
93-92	🔧	454, 454 H.O., 502 REC1463-9382
		351 King REC1463-9382
92-91	🔧	5.7L w/Electronic Ign. REC1463-9382
		5.7LE OMC Cobra (w/Conv. Ign.) REC1463-9382
92	🔧	351 REC1463-9382
		4.3L, 4.3L H.O. (2V Models) REC1463-9382
91-90	🔧	2.3L REC1463-9382
		3.0L (PWC) REC1463-9382
90-87	🔧	350 OMC King Cobra REC1463-9382
		460 OMC King Cobra REC1463-9382
89-88	🔧	2.5L, 3.0L, 4.3L Eng. REC1463-9382
		5.0L, 5.7L REC1463-9382

	Icon	REF
88	🔧	370 OMC King Cobra REC1463-9382
		335 OMC Cobra REC1463-9382
87	🔧	340 OMC King Cobra REC1463-9382
		7.5L REC1463-9382
84-80	🔧	120, 140, 185, 200, 230, 260 HP REC1463-9382
		120, 140, 185, 200, 230, 250, 260 HP REC1463-9382
79	🔧	120, 140, 185, 225, 230, 240, 305, 350, 454HP REC1463-9382
		120, 140, 175, 190, 225, 230, 235 HP REC1463-9382
78	🔧	120, 140, 165, 175, 190, 225, 230, 235 HP REC1463-9382
		120, 140, 165, 175, 190, 225, 230, 235, 245, REC1463-9382
77	🔧	120, 140, 165, 225, 245, 250, 290 HP REC1463-9382
		100, 120, 140, 165, 225, 245, 250 HP REC1463-9382
76	🔧	100, 120, 155, 165, 210, 225, 245, 250 HP REC1463-9382
		90, 120, 155, 210, 215, 235, 250 HP REC1463-9382

BUJÍAS

SPARK PLUG

JUEGOS DE CABLES, ALTO RENDIMIENTO

HD SPARK PLUG WIRE SET

Núcleo del cable de Kevlar de 8 mm antimagnético. Funda de silicona amarilla. Terminales bujías con muelle de acero inox. Terminal del distribuidor de cobre. Terminales bobina. Silicona resistente a altas temperaturas. Garantía de 5 años.

Antimagnetic Kevlar core. Yellow silicone boot & jacket. SS snaplock. Brass distributor terminal. Coil terminals. High resistant silicone. 5 year warranty.

Icono	CYL	ARRANQUE IGNITION		REF	OEM
		CONVEN.	ELECT.		
	110 / 120 / 2.5L / 140 / 3.0L / 140 JET	4	✓	REC15-401	
	3.0L / HO	4		✓	REC15-405 503748
	185 (6 en línea in line)	6	✓	REC15-602	503748
	3.8 L / 4.3 L (229, 262) V6	6	✓	REC15-604	
	4.3L (262) V6	6		✓	REC15-601 503750
	175 / 185 / 190 / 20 / 5.0 L - 5.7 L / (GM) (Mallory)	8	✓	REC15-801	503751
	5.0 L - 5.8 L (FORD)	8	✓	REC15-806	503752 503755
	5.0 L - 5.8 L - EFI (FORD)	8		✓	REC15-805 503753
	225 / 230 / 235 / 240 / 250 / 260 (Mallory)	8	✓	REC15-801	503754
	370 KING / 454 / 7.4 L / 502 / 8.2 L	8	✓	REC15-801	503752 503755
	460 KING	8	✓	REC15-811	503752 503755

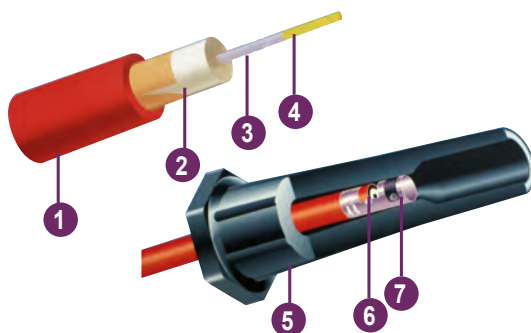

- 1 Camisa de silicona de 8 mm 8 mm silicone jacket
- 2 Látex resistente altas temperaturas Heat resistant latex
- 3 Acero inox Stainless Steel
- 4 Núcleo de Kevlar Kevlar core
- 5 Capuchón de silicona Silicone jacket
- 6 Trenzado especial fibra de vidrio Fiberglass braiding
- 7 Terminal de acero inox Stainless Steel terminal

MÓDULOS IGNICIÓN

IGNITION MODULES

REF	OEM	Icono
REC3854001	3854001 986642	

REF	OEM	Icono	Modelo
REC3854003	3854003 986650		4L, V8

DISTRIBUIDOR

DISTRIBUTOR

TAPA DISTRIBUIDOR

DISTRIBUTOR CAPS

REF	OEM	Icono	Cyl
REC393-9459Q1	380541		4 Cyl

REF	OEM	Icono	Modelo
REC3854217	3854217		V8 EFI

REF	OEM	Icono	Modelo
REC392-9766	3853815		PRESTOLITE V8 Con tornillo Screw on

REF	OEM	Icono	Cyl
REC3854260	3854260		4 cyl

REF	OEM	
REC3854331	3854331	DELCO V6



REF	OEM	
REC3854548	3854548	DELCO V8



REF	OEM	
REC12532	0382133, 382133	MALLORY V8



ROTORES

ROTORS

REF	OEM	
REC3854311	20223	DELCO V8 Encendido electrónico Electronic ignition



REF	OEM	
REC3854261	3854261	DELCO 4 cyl



REF	OEM	
REC3854549	38071	DELCO V6



ARNÉS

HARNESS

ADAPTADOR ELECTRÓNICO

WIRE HARNESS ADAPTER

REF	OEM
REC423-6349	423-6349



PARTES DEL MOTOR

ENGINE PARTS

JUNTAS PARA BASES GM Y FORD





Los Kits están diseñados y catalogados específicamente para aplicaciones marinas. Su calidad es superior a las juntas originales.

MARINE GASKETS TO GM & FORD ENGINES

The gaskets kits are designed and cataloged specifically for marine engine applications. Their quality is even better than the oem's.

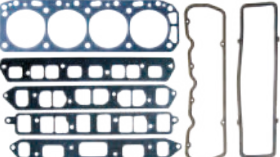





SERIE SERIAL		
1700-17099	KIT JUNTAS DE CULATA (pack individual)	CYLINDER HEAD GASKET (single-packed)
17100-17199	JUEGOS DE CONVERSIÓN Todas las juntas y retenes de aceite que no se encuentran en los juegos de culata. Incluye las juntas del cárter y los retenes.	CONVERSION KITS All gaskets and oil seals not found in a Head Set. This includes timing cover gaskets and seals, oil pan gaskets, and rear main bearing seals.
17200-17299	KIT DE DESCARBONIZACIÓN Todas las juntas y retenes necesarios para el trabajo de las válvulas, incluyendo la culata, la tapa de la válvula y juntas de colector de admisión y colector de escape. (Los juegos de 4 cyl. no contienen las juntas del colector de admisión/escape. Deben pedirse por separado).	HEAD SETS SERIES All gaskets and seals necessary for a valve grinding job, including cylinder head gaskets, valve cover gaskets, intake & exhaust manifold gaskets (except 4 cyl intake set), and valve stem seals.
17300-17399	KIT DE COLECTOR DE ADMISIÓN Juntas de la parte de admisión del colector, retenes y juntas de la base del distribuidor.	INTAKE MANIFOLD SETS Intake manifold side gaskets, intake manifold end seals, and distributor mounting gasket.
17400-17499	KIT DE COLECTOR DE ESCAPE (de colector a culata)	EXHAUST MANIFOLD (manifold-to-cylinder head gaskets)
17700-17749	KIT DE CONTRARROTACIÓN RETÉN TRASERO DEL CIGÜEÑAL Retenes traseros del cigüeñal diseñados para motores de rotación opuesta a la normal. (Retenes de rotación normal incluidos en el set de conversión)	REVERSE ROTATION REAR MAIN BEARING SEAL SETS Rear main bearing seals designed to seal a crankshaft which rotates in the opposite direction from normal (Standard rotation seal is included in conversion set)
17750-17799	KIT DE RETENES TAPA DEL CIGÜEÑAL DE CONTRARROTACIÓN Retenes de la tapa del cigüeñal diseñados para motores de rotación opuesta a la normal. (Retenes de rotación normal incluidos en el set de conversión).	REVERSE ROTATION TIMING COVER SEAL SETS SERIES Timing cover seals designed to seal crankshaft which rotates in the opposite direction from normal (standard rotation seal is included in Conversion set and Timing cover set)
17900-17949	KIT DE TAPA VÁLVULA Todas las juntas de las tapas de las válvulas para sellar el motor.	VALVE COVER SET SERIES All valve cover or push rod cover gaskets (and grommets if required) required to seal one engine.
17950-17999	KIT DE CÁRTER Todas las juntas y retenes del cárter de aceite, o la junta del cárter de aceite de goma moldeada de una pieza, necesarias para sellar un motor.	OIL PAN SETS SERIES All oil pan gaskets & seals, or one-piece molded rubber oil pan gasket, required to seal one engine.

2.5L (100HP, 110HP, 120HP)

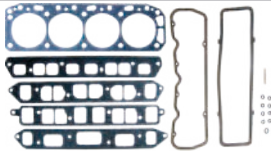
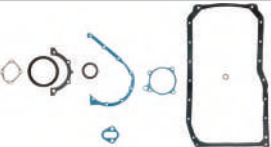
REF	OEM	CULATA	CYLINDER HEAD	
	REC17000	3853336 908611	JUNTA CULATA	CYLINDER HEAD
	REC17200		KIT JUNTAS SUPERIOR	GASKET HEAD SET
REF	INFERIOR	CONVERSION		
	REC17100	Retén 2 piezas, 4 piezas junta cárter.	2 piece rear main bearing seal & 4 piece oil pan gasket	
REF	COLECTOR ADMISIÓN-ESCAPE	MANIFOLD INTAKE & EXHAUST		
	REC27-96429	COBRA	COBRA	
REF	CARTER	OIL PAN		
	REC17950	3853343	KIT JUNTAS CARTER Retén trasero dos piezas, 4 piezas junta cárter.	GASKET OIL PAN SET Two piece rear main bearing seal & 4 piece oil pan gasket





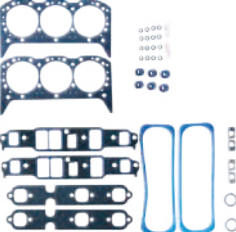

REF	TAPA VÁLVULAS	VALVE COVER
 REF REC17900	3852693 Junta	Gasket
REF	TAPA EMPUJADORES	PUSH ROD COVER
 REF REC17903	3856443 Junta	Gasket

3.0L (115 HP), 3.0L HIGH OUTPUT (130 HP), 130/3.0L (130 HP), 140/3.0L (140 HP)

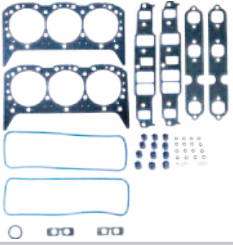

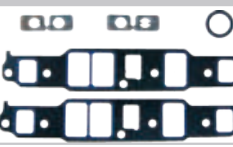
REF	OEM	CULATA	CYLINDER HEAD
 REF REC17000	3853336 908611	JUNTA CULATA	CYLINDER HEAD
 REF REC17200		KIT JUNTAS SUPERIOR	GASKET HEAD SET
REF	OEM	INFERIOR	CONVERSION
 REF REC17102		KIT JUNTAS Retén 1 pieza. Junta cárter 1 pieza.	GASKET SET 1 piece rear main bearing seal 1 piece oil pan gasket
 REF REC17100		Retén 2 piezas, 4 piezas junta cárter.	2 piece rear main bearing seal & 4 piece oil pan gasket
REF	COLECTOR ADMISIÓN-ESCAPE	MANIFOLD INTAKE & EXHAUST	
 REF REC27-96429	COBRA con tapa de colector desmontable.	COBRA with removable end cap.	
 REF REC27-53354	COBRA.	COBRA.	
REF	CARTER	OIL PAN	
 REF REC17950	KIT JUNTAS Retén trasero dos piezas, 4 piezas junta cárter.	GASKET SET Two piece rear main bearing seal & 4 piece oil pan gasket	
REF	TAPA VÁLVULAS	VALVE COVER	
 REF REC17900	3852693 Junta	Gasket	
REF	TAPA EMPUJADORES	PUSH ROD COVER	
 REF REC17903	3856443 Junta	Gasket	

4.3L (150, 160, 175, 180 & 205 HP)

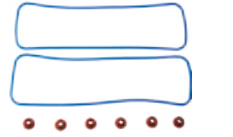







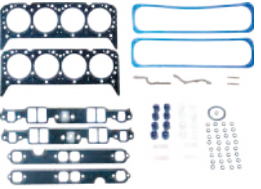
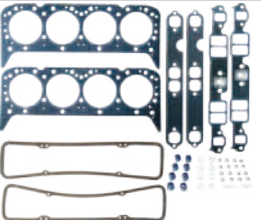

REF	CULATA	CYLINDER HEAD
 REF REC17010	3854299 Se necesitan dos	2 required
 REF REC17210	Motor sin eje equilibrado. Incluye juntas tapa válvulas y retenes.	Engine without balance shaft; valve cover gaskets and premium valve stem seals incl.

	REC17211		Motor con eje equilibrado. Incluye juntas tapa válvulas y retenes.	Engine with balance shaft; valve cover gskts and premium valve stem seals incl.
	REF		INFERIOR	CONVERSION
	REC17110		Motor sin eje equilibrado con retén de 2 piezas y 4 piezas junta cárter. Incluye Junta de cárter.	Engine without balance shaft with 2 pieced rear main bearing seal & 4 pieces oil pan gasket; oil pan gasket incl.
	REC17116		Retén de 1 pieza.	1 piece rear gasket.
	REF		COLECTOR ADMISIÓN-ESCAPE	MANIFOLD INTAKE & EXHAUST
	REC17310	857177	Junta Admisión-Escape	Intake-Exhaust Gasket
	REC27-99757	3853412	Kit juntas colector - escape	Exhaust gasket set
	REF		CARTER	OIL PAN
	REC17970		KIT JUNTAS CARTER 4 piezas junta cárter. (Retén 2 piezas)	GASKET OIL PAN SET 4 piece oil pan gasket (2 piece Seal)
	REC17971	3852655	1 junta carter (Retén 1 pieza)	1 piece oil pan gasket (1 piece seal)
	REF		TAPA VÁLVULAS	VALVE COVER
	REC17920	3854300	Motor sin eje equilibrado.	Engine without balance shaft
	REC17921	3854942	Motor con eje equilibrado.	Engine with balance shaft

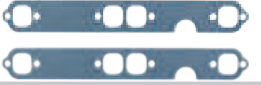
**5.0L (160, 170, 185 HP), 5.0L HIGH OUTPUT (175, 190, 200 HP),
175 (175 HP), 190 (190 HP)**

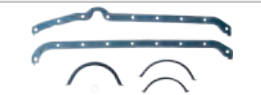
	REF		COLECTOR ADMISIÓN-ESCAPE	MANIFOLD INTAKE & EXHAUST
	REC3852455		Junta escape	Exhaust gasket
	REF		CARTER	OIL PAN
	REC3853341		Retén contrarrotación tapa distribución	Rev. rotation timing cover seal

5.0L V8 (185, 200, 225, 230 HP)

REF	CULATA	CYLINDER HEAD
 REC17020 3853380	Se necesitan dos	2 required
 REC17224	Tornillo centro tapa válvulas. Incluye retenes válvulas.	With center bolt desing valve covers. Premium valve stem seals included.
 REC17220	Tornillo en el lateral tapa válvulas. Incluye retenes válvulas.	Rim bolt desing valve covers. Premium valve stem seals included.
REF	INFERIOR	CONVERSION
 REC17125	Retén de 1 pieza y junta cárter de 1 pieza Incluye junta de cárter.	One-piece rear main bearing seal & 1 piece oil pan gasket. Oil pan gasket included.
 REC17120	Retén de 2 piezas y junta cárter de 4 piezas	Two-piece rear main bearing seal & 4 pieces oil pan gasket.
REF	COLECTOR ADMISIÓN-ESCAPE	MANIFOLD INTAKE & EXHAUST
 REC17320 856365	Kit Juntas Admisión-Escape	Intake-Exhaust Gasket Set
 REC27-33395 856034	Kit juntas colector escape	Oil pan - exhaust gasket set.
REF	CARTER	OIL PAN
 REC17982 3856138	Junta cárter 1 pieza. Junta de cárter incluida.	1 piece oil pan gasket. Molded rubber oil pan gasket included.
 REC17980 855729	Varilla aceite de BABOR con retén trasero de 2 piezas y junta cárter de 4 piezas.	PORT dipstick with 2-piece rear main bearing seal & 4-piece oil pan gasket.
 REC17981	Varilla aceite de ESTRIBOR con retén trasero de 2 piezas y junta cárter de 4 piezas.	STARBOARD dipstick with 2-piece rear main bearing seal & 4-piece oil pan gasket
REF	TAPA VÁLVULAS	VALVE COVER
 REC17931 3852687	Tornillo centro tapa válvulas con juntas.	Molded rubber gaskets incl.
 REC17930 835096	Tornillo en el canto.	Rim bolt desing

REF	RETÉN DISTRIBUCIÓN	OIL SEAL TIMING COVER
 REC3853341	Reten contrarotación. Motor sin tapa distribución de plástico.	Reverse rotation oil seal. Engines without plastic timing cover.

5.0L 307 OHV V8 (210, 215, 225, 230, 235, 245 HP)

REF	CULATA	CYLINDER HEAD
 REC17030	3853380	Se necesitan dos 2 required

 REC17230	Kit Juntas Superior Incluye retenes válvulas.	GASKET HEAD SET Premium valve stem seals incl.
--	--	---

REF	INFERIOR	CONVERSION
 REC17120	Retén de 2 piezas y junta cárter de 4 piezas	Two-piece rear main bearing seal & 4

REF	COLECTOR ADMISIÓN-ESCAPE	MANIFOLD INTAKE & EXHAUST
 REC17320	Kit junta admisión-escape.	Intake-exhaust gasket set.

REF	CARTER	OIL PAN
 REC17980	855729	Varilla aceite a babor con retén trasero de 2 piezas y junta cárter de 4 piezas. Port dipstick with 2-piece rear main bearing seal & 4-piece oil pan gasket.

REF	TAPA VÁLVULAS	VALVE COVER
 REC17930	835096	Tornillo lateral Rim bolt desing







REF	RETÉN DISTRIBUCIÓN	OIL SEAL TIMING COVER
 REC3853341	Reten contrarotación. Motor sin tapa distribución de plástico.	Reverse rotation oil seal. Engines without plastic timing cover.

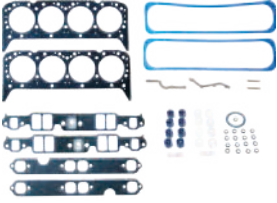
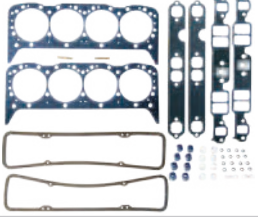
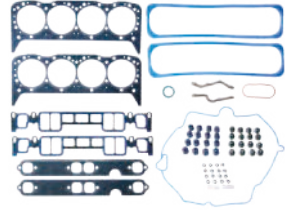

5.8L (210, 215, 235 HP), 5.8L COBRA (240 HP), 250HP, 351 KING COBRA (260 HP)

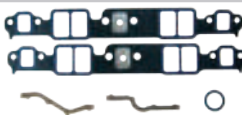
REF	INFERIOR	CONVERSION
 REC17146	KIT JUNTAS INFERIOR Retén de 2 piezas y 4 piezas junta cárter	CONVERSION GASKET SET With 2 piece rear main bearing seal & 4 piece oil pan gasket



REF	COLECTOR ADMISIÓN-ESCAPE	MANIFOLD INTAKE & EXHAUST
 REC3852455	Junta escape	Exhaust gasket





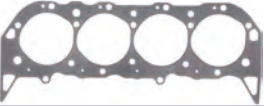
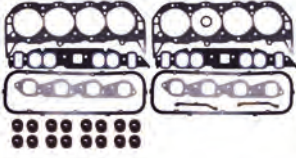
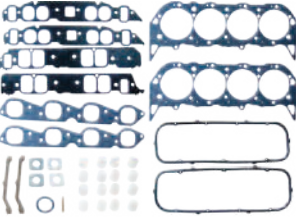
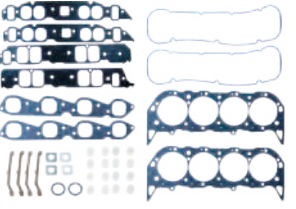
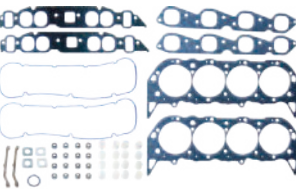

5.7L V8, 250 (215, 220, 250, 260, 270, 290 HP),
250 KING COBRA (235, 270 HP), 260 (250, 260, 270, 290 HP)

REF	CULATA	CYLINDER HEAD
 REC17030	Se necesitan dos	2 required
 REC17214	Tornillo centro tapa válvulas. Incluye retenes válvulas.	With center bolt desing valve covers. Premium valve stem seals included.
 REC17230	Tornillo en el lateral tapa válvulas. Incluye retenes válvulas.	Rim bolt desing valve covers. Premium valve stem seals included.
 REC17232	Gen+ con juntas plástico colector admisión, con juntas tapa válvulas. Retenes válvulas incluidos.	GEN+ w/ plastic intake manifold gskts. valve cover gskts. incl; Premium valve stem seals incl.
REF	INFERIOR	CONVERSION
 REC17125	Retén de 1 pieza y junta cárter de 1 pieza Incluye junta de cárter.	One-piece rear main bearing seal & 1 piece oil pan gasket. Oil pan gasket included.
 REC17120	Retén de 2 piezas y junta cárter de 4 piezas	Two-piece rear main bearing seal & 4 pieces oil pan gasket.
REF	COLECTOR ADMISIÓN-ESCAPE	MANIFOLD INTAKE & EXHAUST
 REC17320	KIT JUNTAS ADMISIÓN-ESCAPE Excepto GEN+ con juntas de admisión de plástico.	INTAKE-EXHAUST GASKET SET Excl. GEN+ eng. w/plastic intake gaskets.
REF	CARTER	OIL PAN
 REC17982	3856138 Junta cárter 1 pieza. Junta de cárter incluida.	1 piece oil pan gasket. Molded rubber oil pan gasket included.
 REC17980	855729 Varilla aceite de BABOR con retén trasero de 2 piezas y junta cárter de 4 piezas.	PORT dipstick with 2-piece rear main bearing seal & 4-piece oil pan gasket.
 REC17981	Varilla aceite de ESTRIBOR con retén trasero de 2 piezas y junta cárter de 4 piezas.	STARBOARD dipstick with 2-piece rear main bearing seal & 4-piece oil pan gasket

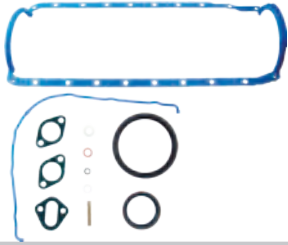
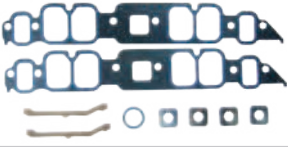
REF	TAPA VÁLVULAS	VALVE COVER
 REC17931	3852687	Tornillo centro tapa válvulas con juntas. Molded rubber gaskets incl.
 REC17930	835096	Tornillo en el canto. Rim bolt desing
REF	RETÉN DISTRIBUCIÓN	OIL SEAL TIMING COVER
 REC3853341		Reten contrarotación Motor sin tapa distribución de plástico. Reverse rotation oil seal Engines w/o plastic timing cover.







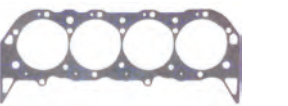
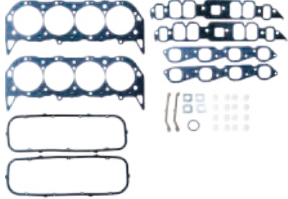
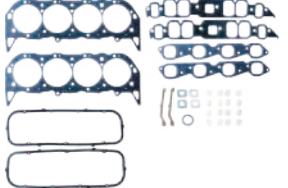

**7.4 L, 454 (330, 335 HP GEN IV)
HIGH OUTPUT KING COBRA (370 HP GEN IV, 330 HP GEN V),
454 KING COBRA (275, 295, 310 HP GEN IV, 295, 310 GEN V)**

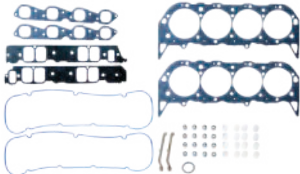
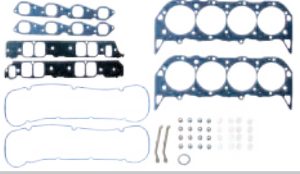
REF	CULATA	CYLINDER HEAD
 REC17040	Gene IV Se necesitan dos	Gene IV 2 required
 REC17042	Gene IV & V. Se necesitan 2.	Gene IV & V. 2 required
 REC17240	Gene IV exc. H.O. con admisión ovalada. Se incluye retenes de válvula.	Gene IV exc. H.O. with oval intake ports. Premium valve stem seals included.
 REC17241	Gene IV solo H.O. Se incluye retenes de válvula	Gene IV only H.O.premium valve stem seals incl.
 REC17242	Gene V EFI y H.O. Se incluye retenes de válvula. Gene VI. EFI y H.O. juntas de goma de tapa válvulas y retenes incluidos	Gene V. EFI or H.O. ; premium valve stem seals incl. Gene VI, EFI & H.O. molded rubber valve cover gaskets and premium valve stem seals incl.
 REC17243	Gene VI sólo H.O. Se incluye retenes de válvula.Juntas tapa valvula de goma.	Gene VI only H.O. Rubber valve cover & premium valve stem seals incl.
REF	INFERIOR	CONVERSION
 REC17140	Gene IV con retén trasero de dos piezas y junta cárter de 4 piezas.	Gene IV w/two piece rear main bearing seal & four piece oil pan gasket.

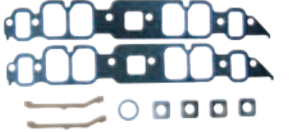
	REC17146		Gene VI con retén trasero de una pieza y junta cárter de 1 pieza. Junta cárter incluida.	Gene VI w/one piece rear main bearing seal & one piece oil pan gasket. oil pan gasket. incl.
	REF		COLECTOR ADMISIÓN-ESCAPE	MANIFOLD INTAKE & EXHAUST
	REC17341		KIT JUNTA ADMISIÓN Gene IV, V y VI sólo H.O. con admisión rectangular. Gene IV, excl. H.O. con admisión rectangular.	INTAKE GASKET SET Gene IV, V & VI, H.O. only w/rectangular intake ports Gene IV excl. H.O. w/rect. intake ports
	REC17340		KIT JUNTA ADMISIÓN Gene IV, excl. H.O. con admisión oval. Gene V y VI exc. EFI y H.O. con admisión ovalada.	INTAKE GASKET SET Gene IV excl. H.O. w/oval intake ports Gene V & VI, excl. EFI & H.O. w/oval intake ports
	REC17342		KIT JUNTA ADMISIÓN Gene V y VI sólo EFI	INTAKE GASKET SET Gene V & VI, EFI only
	REC27-46820	3852472	KIT JUNTA ESCAPE Gene IV, V y VI.	EXHAUST GASKET SET Gene IV, V & VI
	REF		RETÉN TRASERO CIGÜEÑAL	Crankshaft rear seal
	REC26-14756		Gene IV Retén Contrarrotación dos piezas	Gene IV Reverse rotation oil seal Two-pieces
	REF		TAPA VÁLVULAS	VALVE COVER
	REC17935	856626	Gene IV	Gene IV
	REC17937	3853513	Gene V & VI	Gene V & VI

8.2 L, 502 KING COBRA (375 HP GEN IV, 375 HP GEN V)

	REF	CULATA	CYLINDER HEAD
	REC17048	JUNTA CULATA Gene IV, V & VI .Se necesitan 2.	CYLINDER HEAD Gene IV, V & VI. 2 required
	REC17248	KIT JUNTAS SUPERIOR Gene IV. Se incluye retenes de válvulas.	GASKET HEAD SET Gene IV. premium valve stem seals incl.
	REC17248	KIT JUNTAS SUPERIOR Gene V exc. EFI. Se incluye retenes de válvula y juntas tapa válvulas.	GASKET HEAD SET Gen V exc. EFI; premium valve stem seals & valve cover gskts.incl.

	REC17207	KIT JUNTAS SUPERIOR Gene V solo EFI. Se incluye retenes de válvula y juntas tapa válvulas.	GASKET HEAD SET Gen V EFI only; premium valve stem seals & valve cover gskts. incl.
	REC17207	KIT JUNTAS SUPERIOR Gene VI solo EFI. Se incluye retenes de válvula y juntas tapa válvulas	GASKET HEAD SET Gen VI EFI only; premium valve stem seals & valve cover gskts. incl.
	REF	INFERIOR	CONVERSION
	REC17140	Gene IV con retén trasero de dos piezas y junta cárter de 4 piezas.	Gene IV w/two piece rear main bearing seal & four piece oil pan gasket.
	REC17146	Gene VI con retén trasero de una pieza y junta cárter de 1 pieza. Junta cárter incluida.	Gene VI w/one piece rear main bearing seal & one piece oil pan gasket. oil pan gasket. incl.
	REF	COLECTOR ADMISIÓN-ESCAPE	MANIFOLD INTAKE & EXHAUST
	REC17341	KIT JUNTA ADMISIÓN Gene IV, V y VI sólo H.O. con admisión rectangular. Gene IV, excl. H.O. con admisión rectangular.	INTAKE GASKET SET Gene IV, V & VI, H.O. only w/rectangular intake ports Gene IV excl. H.O. w/rect. intake ports
	REC27-46820	KIT JUNTA ADMISIÓN Gene IV, excl. H.O. con admisión oval. Gene V y VI exc. EFI y H.O. con admisión ovalada.	INTAKE GASKET SET Gene IV excl. H.O. w/oval intake ports Gene V & VI, excl. EFI & H.O. w/oval intake ports
	REF	RETÉN TRASERO CIGÜEÑAL	CRANKSHAFT REAR SEAL
	REC26-14756	Gene IV Retén Contrarrotación dos piezas	Gene IV Reverse rotation oil seal Two- pieces
	REF	TAPA VÁLVULAS	VALVE COVER
	REC17935	Gene IV	Gene IV
	REC17937	Gene V & VI	Gene V & VI
	REF	CARTER	OIL PAN
	REC17986	Junta Carter 1 pieza, incluye junta de goma	GASKET OIL PAN 1 piece oil pan gasket. rubber gasket included.

8 CIL
5.0 L (160, 170, 185 HP), 5.0L HIGH OUTPUT (175, 190, 200 HP), 175 HP, 190 HP - FORD 302 (5.0)
5.8L (210, 215, 235 HP), 5.8L COBRA (240 HP), 250 HP, 351 KING COBRA (260 HP), FORD 351W

	REF		MANIFOLD INTAKE & EXHAUST
	REC3852455	Junta escape	Exhaust gasket

SISTEMA DE ESCAPE Y ADMISIÓN

EXHAUST & INTAKE SYSTEM

DESPIECES COLECTORES Y CODOS

MANIFOLDS & ELBOWS PARTS

120HP, 4 CYL. 153CID / 2.5L GM SERIES 400

	REF	OEM		
1	REC27-52546	311068	JUNTA COLECTOR	GASKET - EXHAUST MANIFOLD
2	REC13-39107	306470	CIERRE	LOCKWASHER
3	REC11-862903	552938	TUERCA	NUT
4	REC13-35048	120177	CIERRE	LOCKWASHER
5	REC3852142	306422	TUERCA	NUT

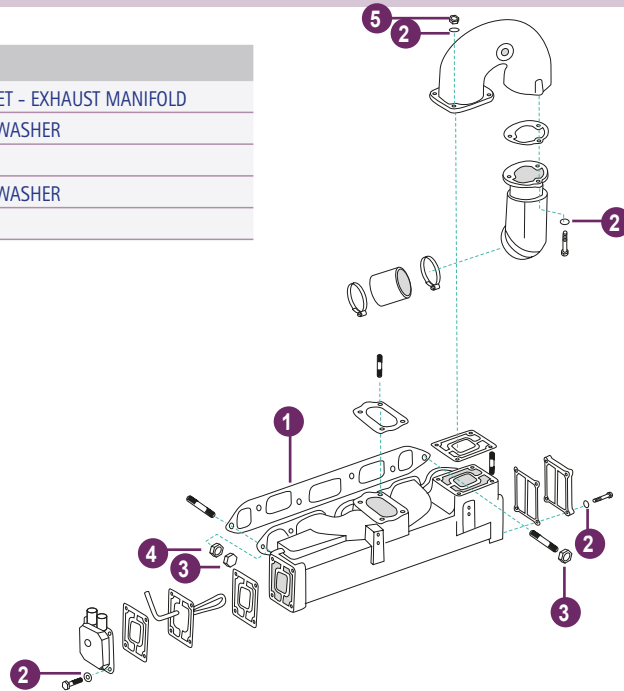

120HP, 4 CYL. 153CID / 2.5L GM (1981-86)

	REF	OEM		
1	REC27-52546	311068	JUNTA COLECTOR ESCAPE	GASKET - EXHAUST MANIFOLD
2	REC3850495	3850495	JUNTA CODO ESCAPE	GASKET - EXHAUST ELBOW
3	REC13-39107	306470	CIERRE	LOCKWASHER
4	REC11-862903	552938	TUERCA	NUT
5	REC3852142	306422	TUERCA	NUT
6	REC13-35048	120177	CIERRE	LOCKWASHER

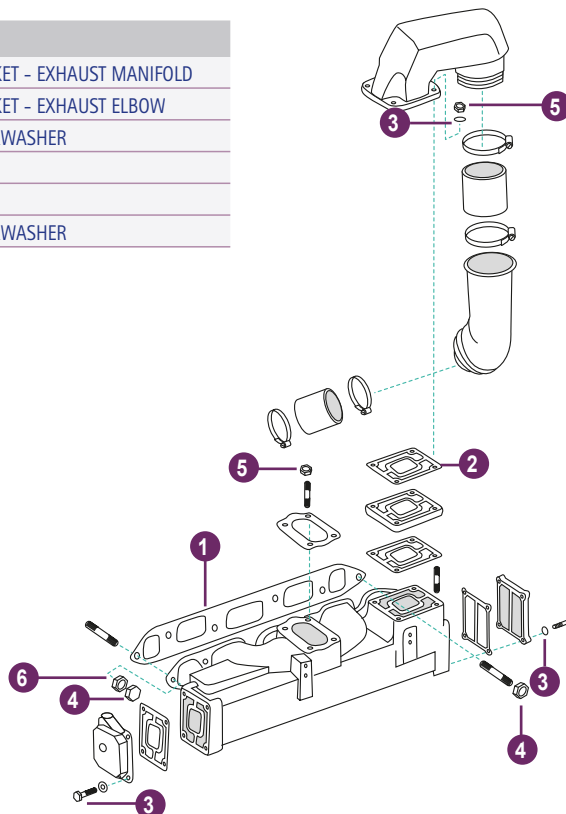

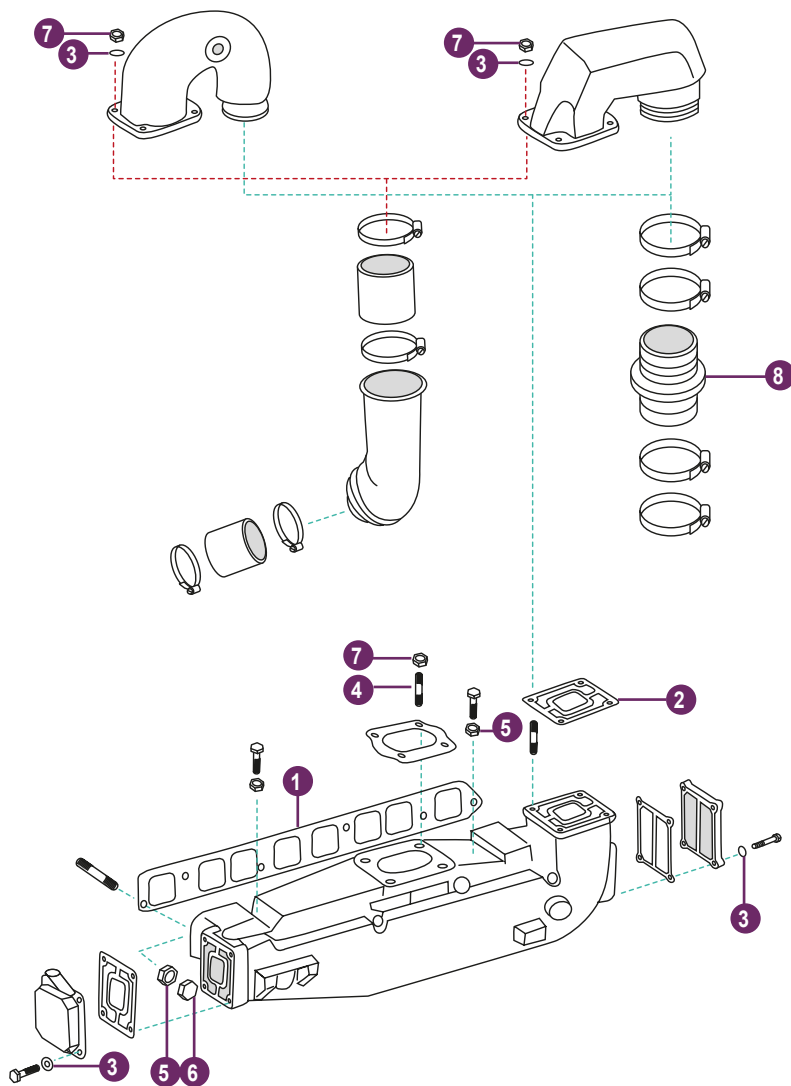

	REF	OEM		
1	REC27-53354	908079	JUNTA COLECTOR ESCAPE	GASKET - EXHAUST MANIFOLD
2	REC3850495	3850495	JUNTA CODO	GASKET - EXHAUST ELBOW
3	REC13-39107	306470	CIERRE	LOCKWASHER
4	REC16-70236	314616	PERNO CARBURADOR	STUD - CARBURETOR
5	REC13-35048	120177	CIERRE	LOCKWASHER
6	REC11-862903	552938	TUERCA	NUT
7	REC3852142	306422	TUERCA	NUT
8	REC3863450	3852741	MANGUITO ESCAPE	EXHAUST HOSE

4.3 / 4.3 H.O. GM 262 CID V6 (1986-90)

Este colector ya no se fabrica. Para sustituirlo utilizar todas las piezas del motor modelo: 4.3GM (1991+)
 This manifold is obsolete. Parts of the 4.3GM (1991+) must be used to replace it.



4.3 GM 262 CID V6 (1991+)

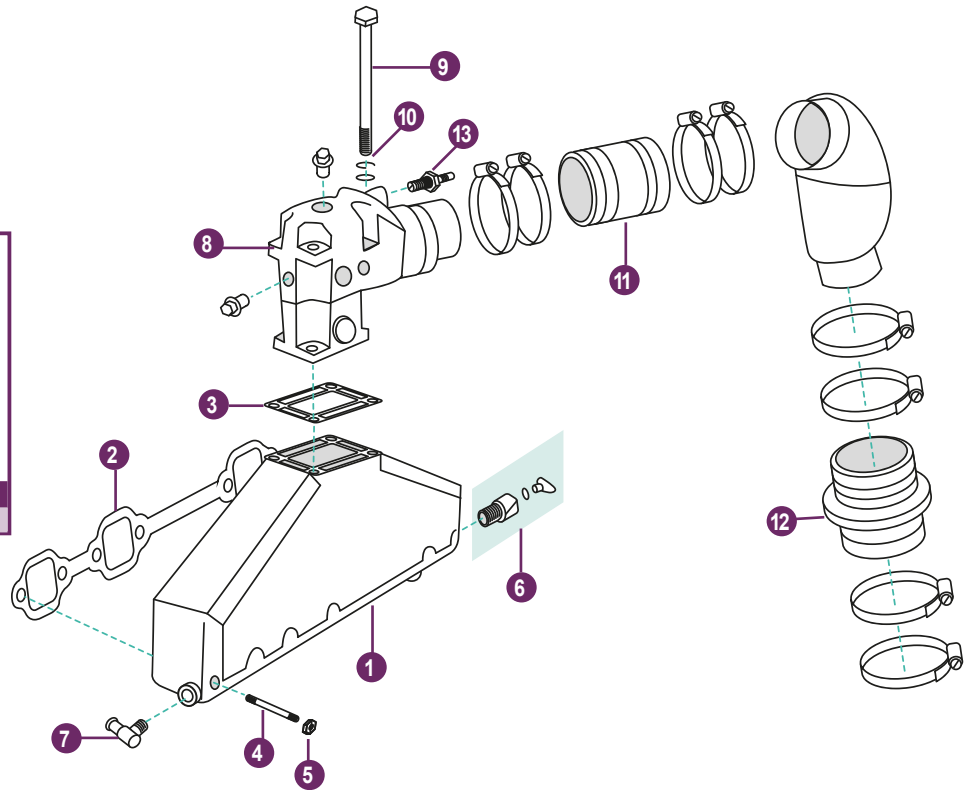
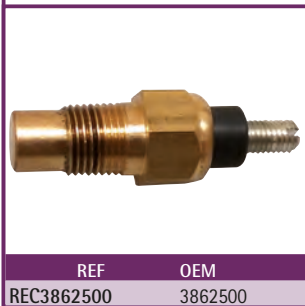

	REF	OEM		
1	MAR499	3847499	COLECTOR ESCAPE	EXHAUST MANIFOLD ASSEMBLY
2	REC27-99757	3853412	JUNTA COLECTOR ESCAPE	GASKET - EXHAUST MANIFOLD
3	REC3863191	351325	JUNTA CODO ESCAPE	GASKET - EXHAUST ELBOW
4	REC3852467	3852467	PERNO	STUD
5	REC46335	3853404	TUERCA	NUT
6	REC479956		RACOR COLECTOR	STRAIGHT FITTING
7	REC3852538	3852538	TORNILLO CODO	ELBOW FITTING
8	MAR061	3857944	CODO ESCAPE	EXHAUST ELBOW ASSEMBLY
9	REC3852830	3852830	TORNILLO	SCREW
10	REC13-35048	120177	CIERRE	LOCKWASHER
11	REC3852696	3852696	MANGUITO ESCAPE	EXHAUST HOSE
12	REC3863450	3852741	MANGUITO ESCAPE	EXHAUST HOSE
13	REC3862500	3862500	SENSOR TEMPERATURA	TEMPERATURE SENSOR

800 GM 305/350 CID V8
BLOQUE PEQUENO | SMALL BLOCK (1979-89)

REF	OEM		
1	REC27-33395	3852468	JUNTA COLECTOR ESCAPE GASKET - EXHAUST MANIFOLD
2	REC3863191	3863191	JUNTA CODO ESCAPE GASKET - EXHAUST ELBOW
3	REC764799	764799	TAPA CAP
4	REC3852467	3852467	PERNO STUD
5	REC46335	908700	TUERCA NUT
6	REC13-35048	309336	CIERRE LOCKWASHER
7	REC13-39107	306325	CIERRE LOCKWASHER
8	REC3852742	3852742	MANGUITO ESCAPE (COBRA) EXHAUST HOSE (COBRA)

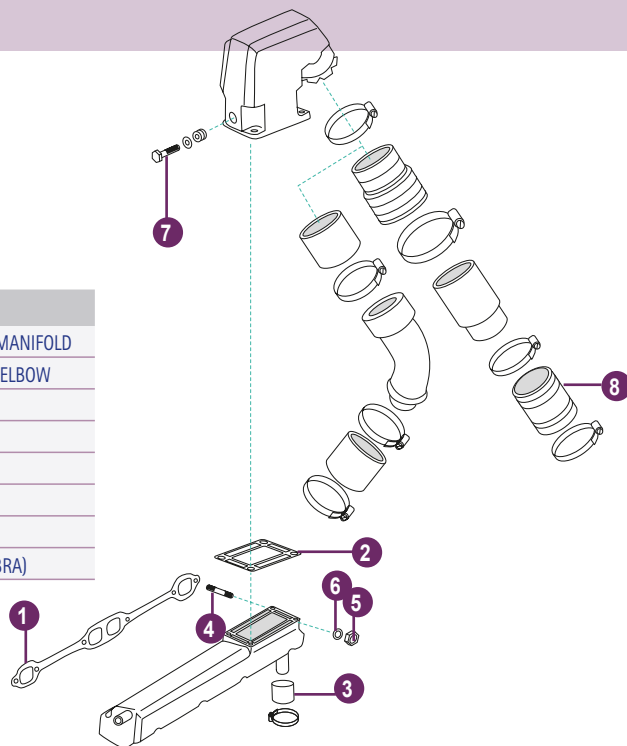

5.7L GM 350 CID V8
(1990+)

REF	OEM		
1	MAR501	3857723	COLECTOR ESCAPE EXHAUST MANIFOLD ASSEMBLY
2	REC27-33395	3852468	JUNTA COLECTOR ESCAPE GASKET - EXHAUST MANIFOLD
3	REC3863191	3863191	JUNTA CODO ESCAPE GASKET - EXHAUST ELBOW
4	REC3852467	3852467	PERNO STUD
5	REC46335	3853404	CIERRE LOCKNUT
6	REC479956		RACOR COLECTOR STRAIGHT FITTING KIT
7	REC3852538	3852538	RACOR CODO ELBOW FITTING
8	MAR061	3857944	CODO ESCAPE EXHAUST ELBOW
9	REC3852830	3852830	TORNILLO SCREW
10	REC13-35048	120177 306405	CIERRE LOCKWASHER
11	REC3852696	3852696	MANGUITO ESCAPE EXHAUST HOSE
12	REC3863450	3852741	MANGUITO ESCAPE EXHAUST HOSE
13	REC3862500	3862500	SENSOR TEMPERATURA TEMPERATURE SENSOR

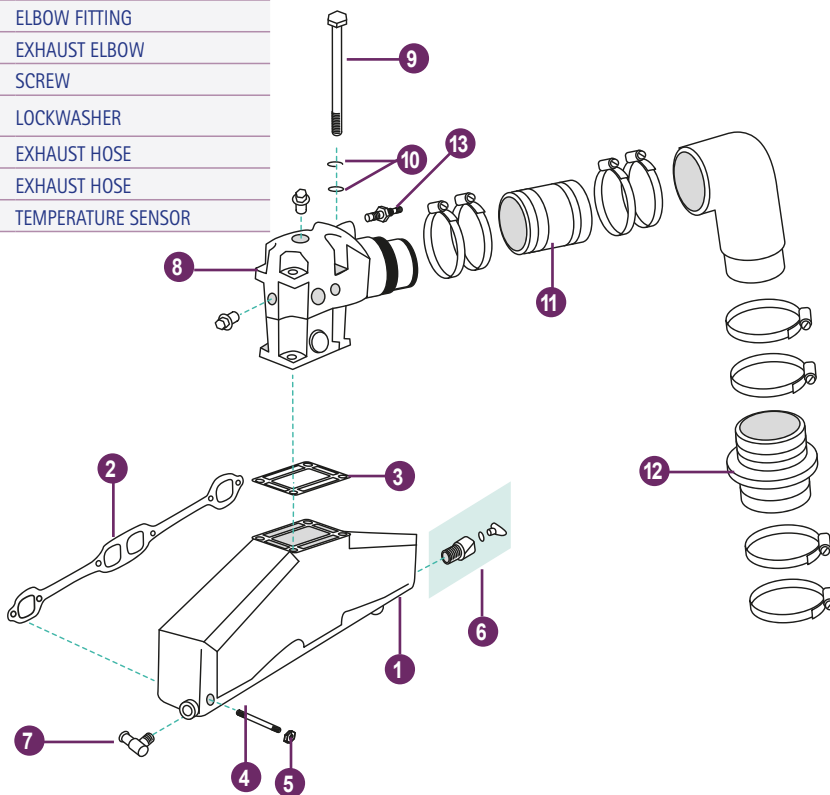

REF	OEM
REC3862500	3862500

5.0/5.8L & EFI FORD 302/351 CID V8
(1991+)

	REF	OEM		
1	REC3852455	3852455	JUNTA COLECTOR ESCAPE	GASKET - EXHAUST MANIFOLD
2	REC3863191	3863191	JUNTA CODO ESCAPE	GASKET - EXHAUST ELBOW
3	REC3853434	3853434	PERNO	STUD
4	REC46335	3853404	TUERCA	NUT
5	REC10-37612	3853155	TORNILLO	SCREW
6	MAR061	3857944	CODO ESCAPE (1988-96) CARB.	EXHAUST ELBOW ASSEMBLY (1988-96 CARB.)
7	REC3852830	3852830	TORNILLO	SCREW
8	REC13-35048	120177 306405	CIERRE	LOCKWASHER
9	REC3852696	3852696	MANGUITO ESCAPE	EXHAUST HOSE
10	REC3863450	3852741	MANGUITO ESCAPE	EXHAUST HOSE

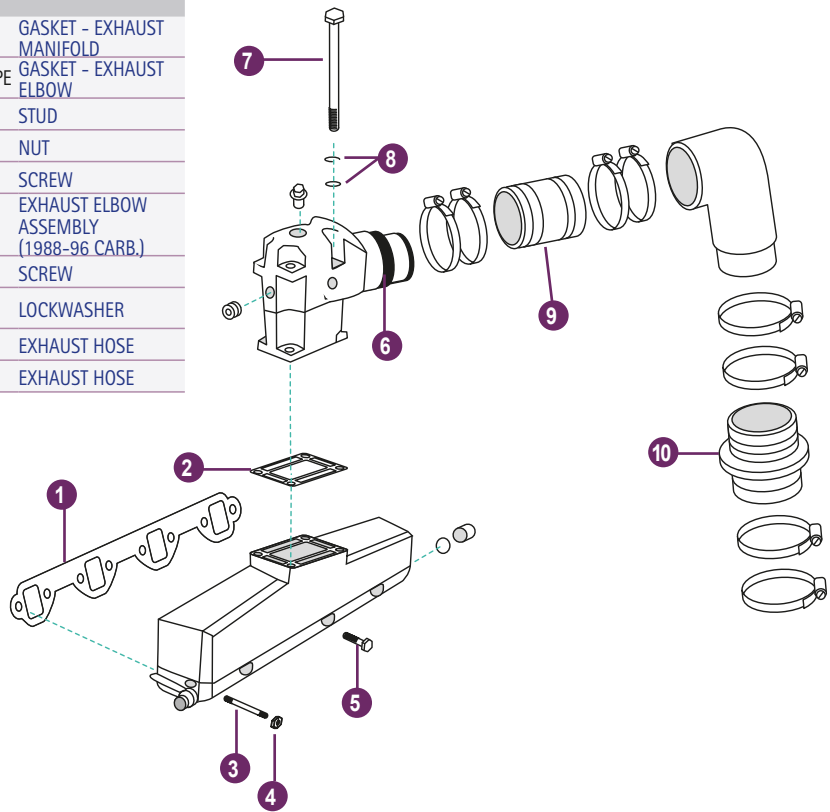

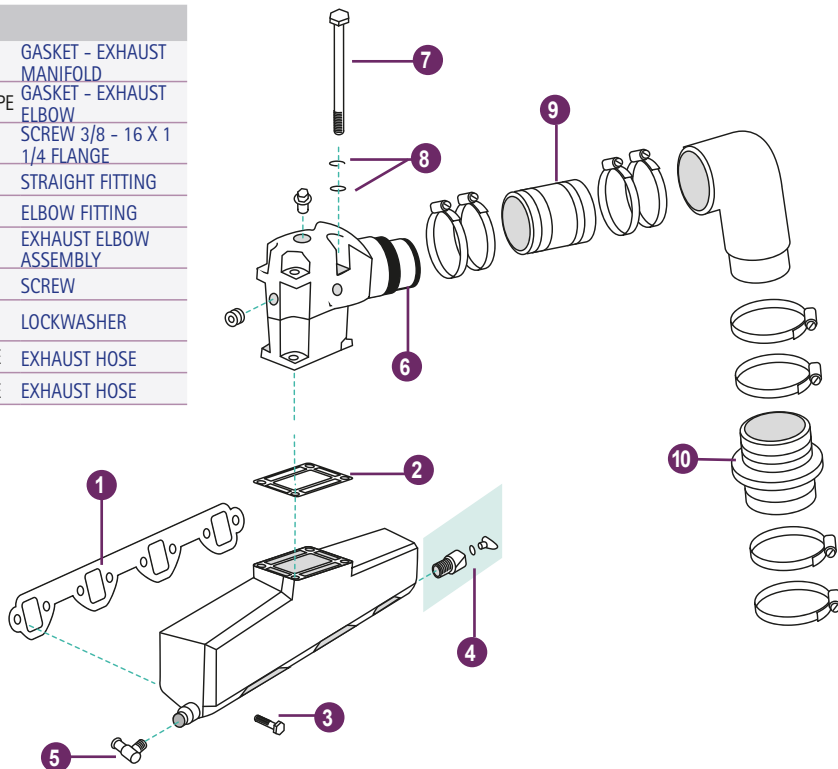

7.4/8.2L GM 454/502 CID V8
(1991+)

	REF	OEM		
1	REC27-46820	3852472	JUNTA COLECTOR ESCAPE	GASKET - EXHAUST MANIFOLD
2	REC3863191	3863191	JUNTA CODO ESCAPE	GASKET - EXHAUST ELBOW
3	REC10-37612	3853326	TORNILLO	SCREW 3/8 - 16 X 1 1/4 FLANGE
4	REC479956		RACOR COLECTOR	STRAIGHT FITTING
5	REC3852538	3852538	RACOR CODO	ELBOW FITTING
6	MAR061	3857944	CODO ESCAPE	EXHAUST ELBOW ASSEMBLY
7	REC3852830	3852830	TORNILLO	SCREW
8	REC13-35048	120177 306405	CIERRE	LOCKWASHER
9	REC3852696	3852696	MANGUITO ESCAPE	EXHAUST HOSE
10	REC3863450	3852741	MANGUITO ESCAPE	EXHAUST HOSE





TAPA COLECTORES

REF	OEM		
REC3852476	909829 3852476	240HP, 302 & 351 CID FORD	

MANIFOLD COVER



REF	OEM		
REC764799	764799	240HP, 302 & 351 CID FORD	

JUNTAS COLECTOR DE ESCAPE



REF	OEM		
REC3852455	3852455	240HP 302 & 351 CID FORD 170, 175, 190, 235 HP V8	

EXHAUST MANIFOLD GASKET

JUNTAS CODOS

REF	OEM		
REC878982	912477	2.3 FORD 4 en línea 4 inline	



ELBOW GASKET

REF	OEM		
REC3863191	913784	240HP, 302 & 351 CID FORD	

BOMBA DE CIRCULACIÓN BLOQUE

BLOCK CIRCULATING PUMP



BOMBAS

REF	OEM		
REC46-8M0113733	3858340	GM 4L	

PUMPS

REF	OEM		
REC46-8M0113734	3853850 985429	GM V6 & V8 (bloque pequeño small block)	

MANGUITO

REF	OEM		
REC32-33189	312781	COBRA	

HOSE

REF	OEM	
REC32-8M0071007	0509282	

UNIDADES DE TRANSMISIÓN TRANSMISSION UNIT

ÁNODO

REF	OEM	(kg)	
ZN REC987067	3854061	0,98	COBRA 5700
AL REC987067AL			



REF	OEM	(kg)	
ZN REC3855411	3855411	1,04	COBRA (1994-98)
AL REC3863193AL		0,41	



REF	OEM	(kg)	
ZN REC983494	983494	0,82	400-800 (1978-85)
AL REC983494AL		0,32	



REF	OEM	(kg)	
ZN REC976669	976669	0,43	
AL REC976669AL		0,17	

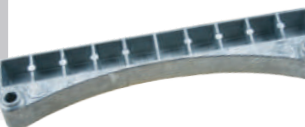

REF	OEM	(kg)	
ZN REC436745	436745	0,22	400-800 (1978-85)
AL REC436745AL		0,09	COBRA (1986-93)



REF	OEM	(kg)	
ZN REC397768	397768	0,31	
AL REC397768AL		0,12	



ANODE

REF	OEM	(kg)	
ZN REC986158	3853930	0,61	TRANSOM COBRA (1986-93)
AL REC986158AL			



REF	OEM	(kg)	
ZN REC983952	984547	0,91	COBRA
AL REC983952AL	983952	0,35	



REF	OEM	(kg)	
ZN REC982438	982438	0,83	100-245 HP
AL REC982438AL			



REF	OEM	(kg)	
ZN REC431708	431708	0,27	400-800 (1978-85)
AL REC431708AL		0,24	COBRA (1986-93)



REF	OEM	(kg)	
ZN REC55125-90J01	5032542, 5032929	0,25	



KITS

REF	
AL RECKITOMCCOBRAAL	
MG RECKITOMCCOBRAAM	
ZN RECKITOMCCOBRAZN	



KIT

REF	
AL RECKITOMCSTRINGERAL	
MG RECKITOMCSTRINGERM	
ZN RECKITOMCSTRINGERZLN	

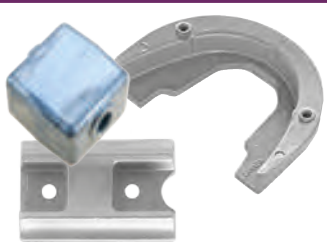

	REF	OEM		
1	REC3852045	303067	ARO TORICO	O-RING
2	REC25-70937	911686	ARO TÓRICO	O-RING
3	REC911685	911685	RETÉN	OIL SEAL
4	REC3850812	3850812	CRUCETA CARDAN 1990-93	UNIVERSAL JOINT
	REC75832T	912214	CRUCETA CARDAN 1986-99	UNIVERSAL JOINT
5	REC25-25439	3852565	ARO TÓRICO	O-RING
6	RM3852516	910953	ARO RETENEDOR	RETAINER RING
7	REC3589522	3852561	TAPA LATERAL	THRUST PLATE
8	REC3589524	3852562	TAPA LATERAL	THRUST PLATE
9	REC911698	911698	JUNTA	GASKET
10	REC911700	911700	ARO TÓRICO	O-RING
11	REC909316	909316	ARO TÓRICO	O-RING
12	REC3853655	3853655	RETÉN	OIL SEAL
13	REC802385	911702	JUNTA	GASKET
14	REC911703	911703	TAPA BOMBA AGUA	WEAR PLATE
15	REC777128	777128	TURBINA	IMPELLER
16	REC764197	764197	CASQUILLO CUERPO BOMBA	WATER PUMP LINER
17	REC911704	911704	RETÉN	OIL SEAL
18	REC984744	984744	TAPA BOMBA AGUA	PUMP HOUSING
19	REC983878	983878	COJINETE	BEARING
	REC911678	911678	GRUESO 0.003	SHIM 0.003
	REC911679	911679	GRUESO 0.004	SHIM 0.004
	REC911680	911680	GRUESO 0.005	SHIM 0.005
	REC911681	911681	GRUESO 0.010	SHIM 0.010
21	REC915840	915840	KIT JUNTAS	GASKET KIT



COBRA (1986-93)

Las colas Cobra con motores 3.0L de (1986-89) utilizan una parte inferior de menos diámetro como los motores 2.3L de (1987-90). Las posteriores utilizan la misma parte inferior que los V6 y V8.

The (1986-89) Cobra Sterndrives with four-cylinder 3.0L engines utilize a small diameter lower gear housing. The (1990-93) four-cylinder 3.0L Cobra Sterndrives use the same large diameter lower gear housing as the 1986-1993 V6 and V8 powered Cobra Sterndrives. (1987-90) 2.3L engines use the small gear housing.

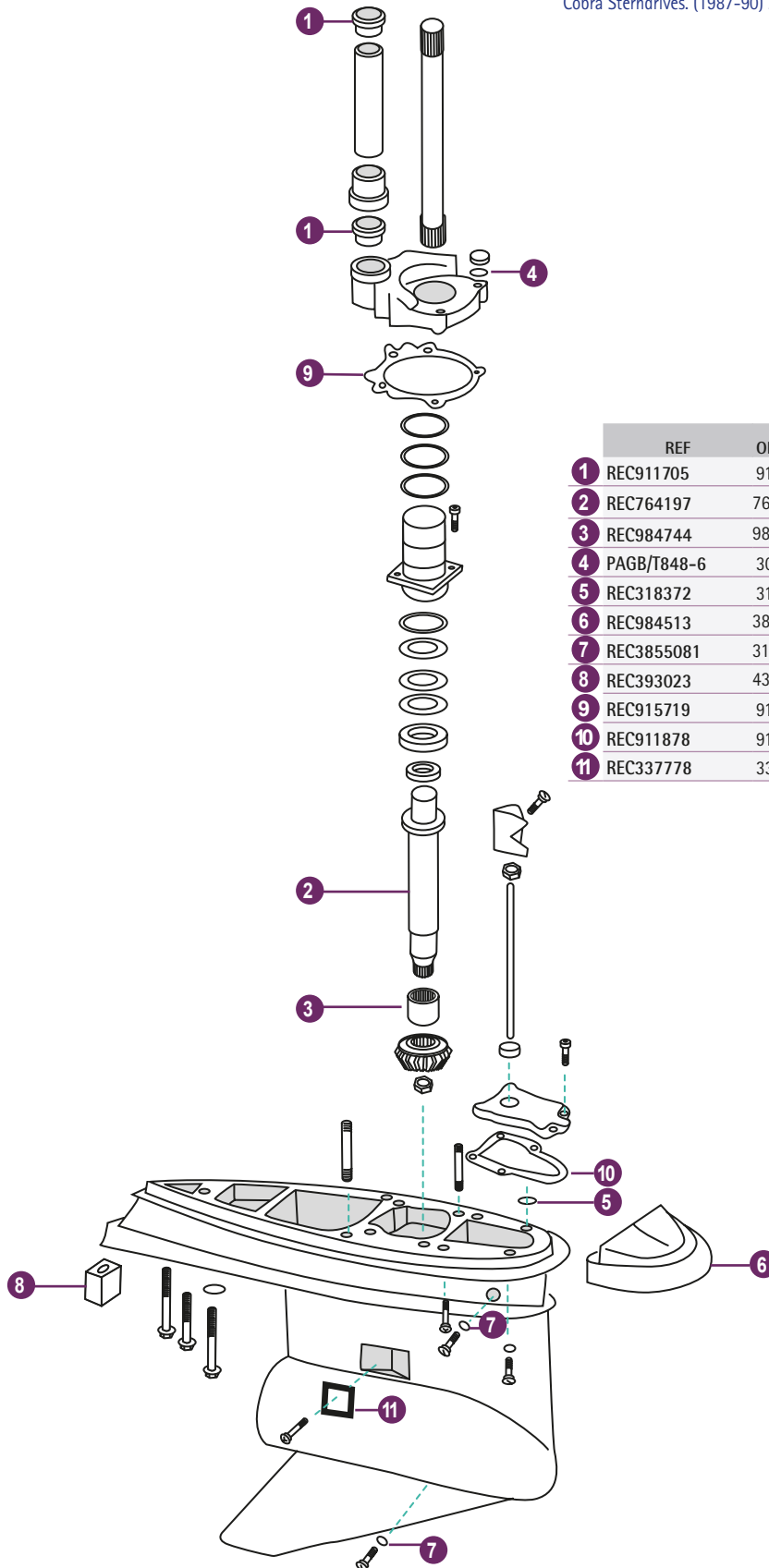

REF	OEM		
1	REC911705	911705	RETÉN SEAL
2	REC764197	764197	CASQUILLO CUERPO BOMBA WATER PUMP LINER
3	REC984744	984744	TAPA BOMBA AGUA PUMP HOUSING
4	PAGB/T848-6	305981	ARANDELA WASHER
5	REC318372	318372	ARO TÓRICO O-RING
6	REC984513	3853818	ANODO ANODE
7	REC3855081	311598	ARO TÓRICO O-RING
8	REC393023	436745	ANODO ANODE
9	REC915719	915719	RETÉN SEAL
10	REC911878	911878	RETÉN GASKET
11	REC337778	337778	REJILLA SCREEN

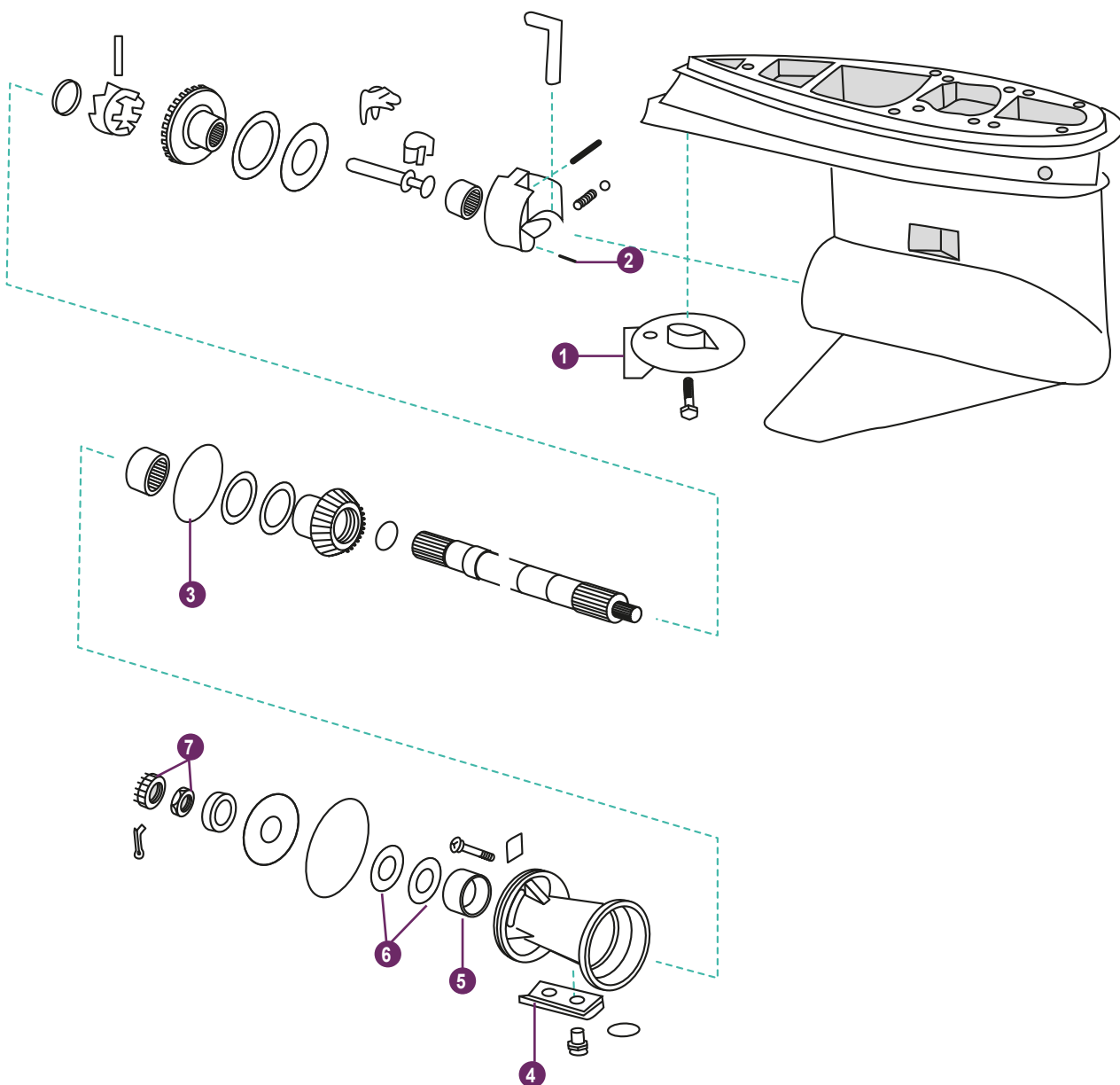

	REF	OEM		
1	TEN00712	912392	ALETA	TRIM TAB
2	REC331880	331880	PASADOR	PIN
3	REC967344	313446	ARO TÓRICO	O-RING
4	REC431708AL	431708	ANODO	ANODE
5	REC387247	387247	COJINETE (1986-90)	BEARING (1986-90)
6	REC334950	334950	RETÉN (1986-90)	OIL SEAL (1986-90)
6	REC330137	330137	RETÉN (1991-93)	OIL SEAL (1991-93)
7	REC398042	5008966	KIT TUERCA HÉLICE	NUT & KEEPER
8	REC439967	439967 984458	KIT 3.0L (1990-93), V6 / V8 (1986-93) KING COBRA	KIT 3.0L (1990-93), V6 / V8 (1986-93) KING COBRA

COBRA (1994-98)



REF
REC39631

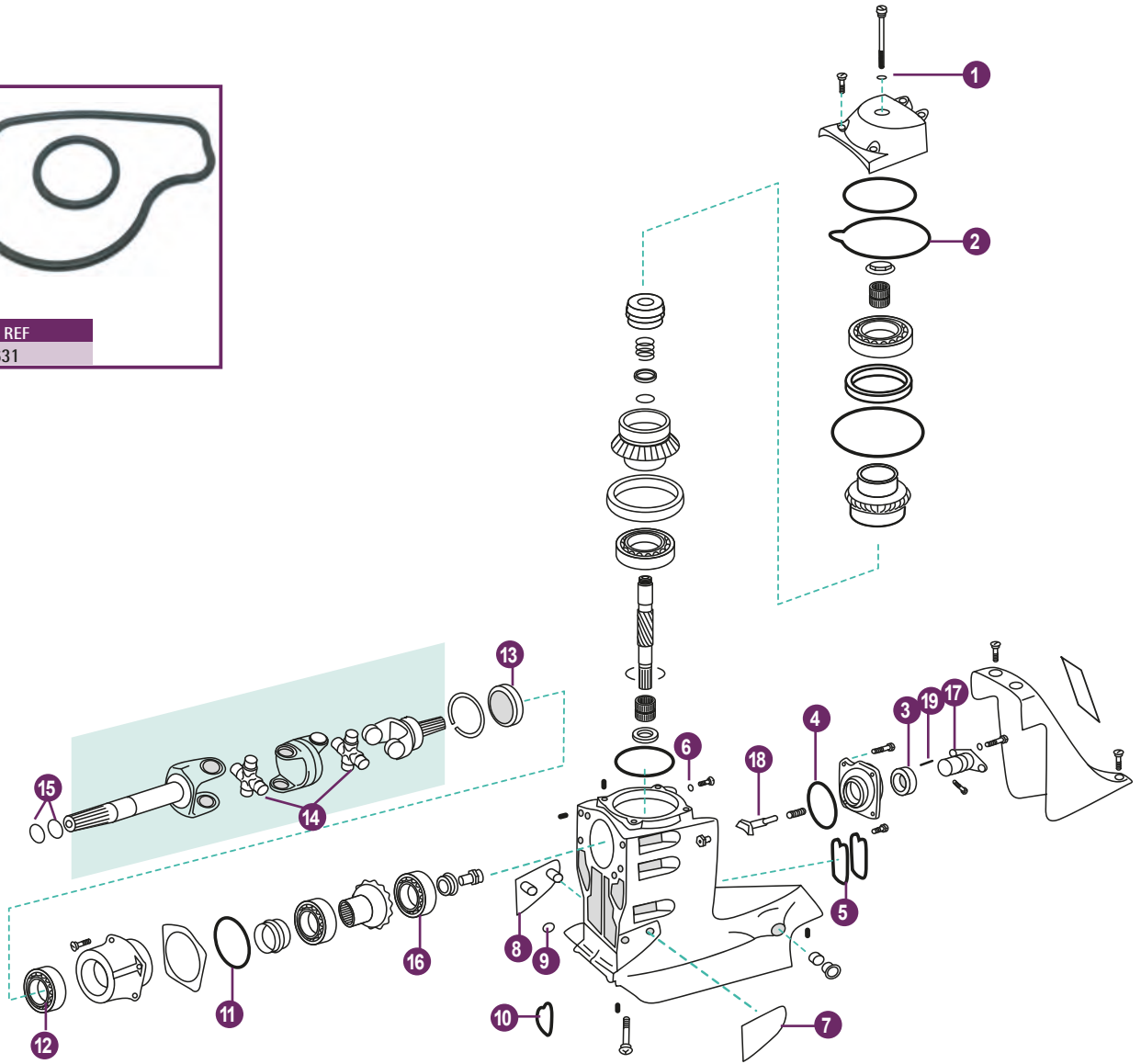

	REF	OEM		
1	REC3852045	303067	ARANDELA	O-RING
2	REC3852317	3852317	JUNTA	GASKET
3	REC853868	853858	RETEN ACEITE	OIL SEAL
4	REC925093	925093	ARANDELA	O-RING
5	REC3852279	3852279	JUNTA	GASKET
6	REC3855081	333572	JUNTA	GASKET
7	REC3589522	3852561	TAPA	THRUST PLATE
8	REC3589524	3852562	TAPA	THRUST PLATE
9	REC3852165	910953	ARO RETENEDOR	RETAINING RING
10	REC3852560	3852560	RETEN	SEAL
11	REC967344	3852308	ARANDELA	O-RING
12	REC183247	3850853	COJINETE	BEARING
13	REC3852272	3852272	RETEN ACEITE	OIL SEAL
14	REC3850812	3850812	CRUCETA CARDAN	U-JOINT
15	REC25-25439	3852565	ARANDELA	O-RING
16	REC983878	983878	COJINETE	BEARING
17	REC3856008	897816	PISTON	PISTON
18	RM3856502	814603	PUNTERA CONO SELECTOR	SHOEM SHIFT
19	REC951924	951924	PIN	PIN

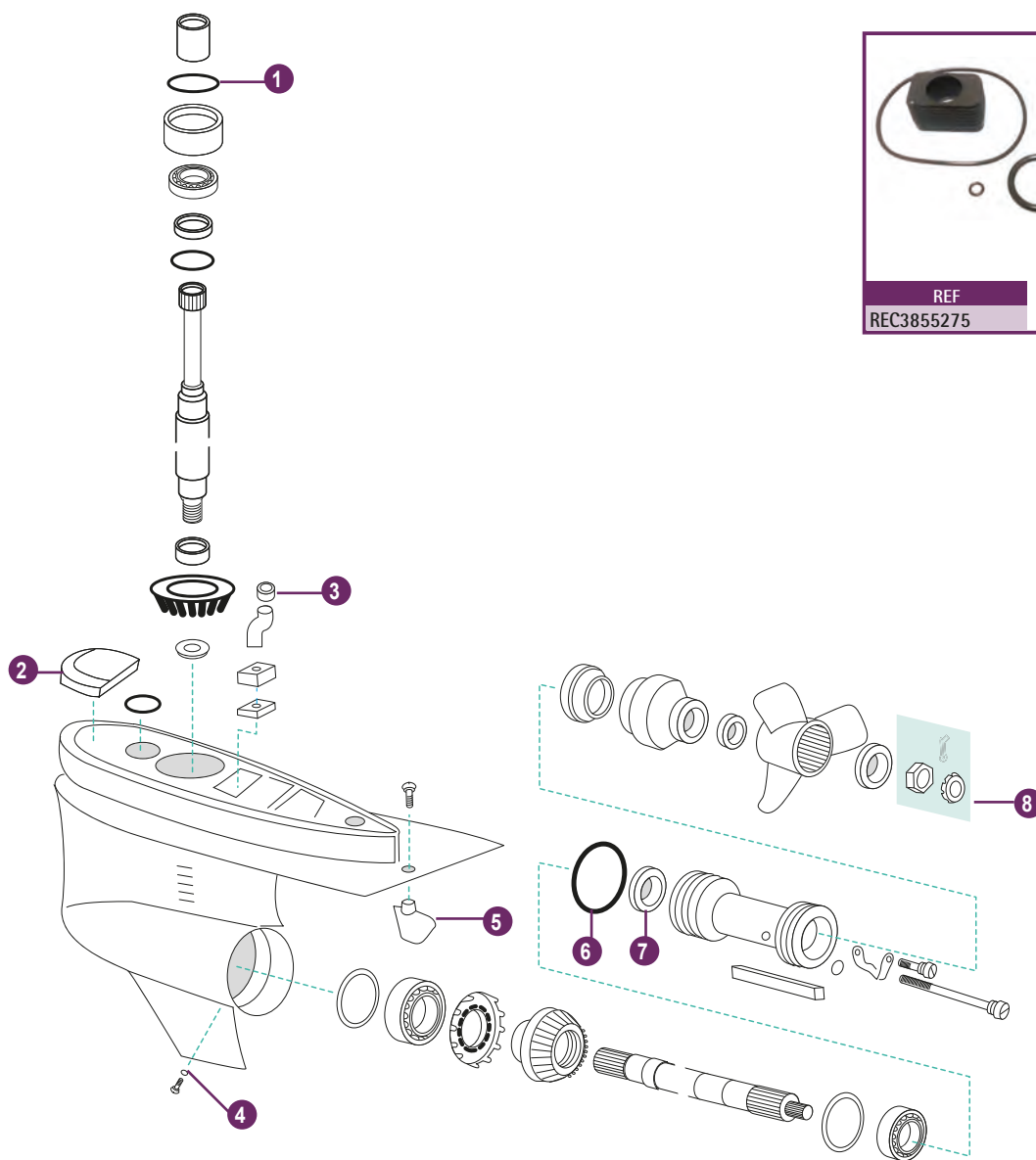

	REF	OEM		
1	REC3852866	3852866	ARO	O-RING
2	REC3863193AL	3855411	ANODO	ANODE
3	REC3852315	3852315	SUPLEMENTO	GROMMET
4	REC3855081	333572	ARANDELA	WASHER
5	REC854040	3854402	TIMON COLA	TRIM TAB
6	REC3852865	3852865	ARO	O-RING
7	REC3863090	3863090	RETÉN ACEITE	OIL SEAL
8	REC398042	5008966	KIT TUERCA HÉLICE	NUT & KEEPER

400-800 (1973-85)

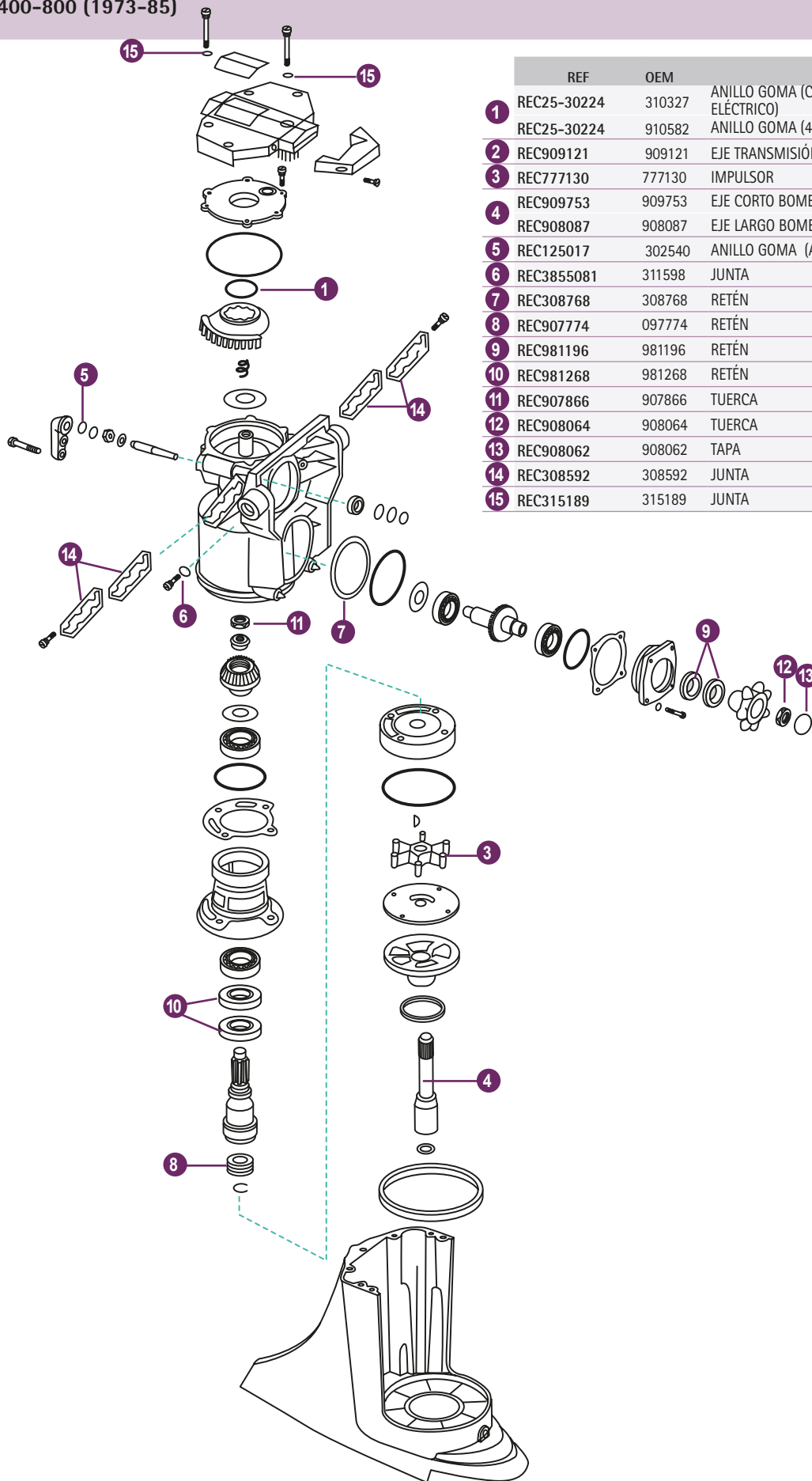

	REF	OEM	
1	REC25-30224	310327	ANILLO GOMA (CAMBIO ELÉCTRICO) O-RING (ELECTRIC SHIFT)
	REC25-30224	910582	ANILLO GOMA (400-800) O-RING
2	REC909121	909121	EJE TRANSMISIÓN DRIVE SHAFT
3	REC777130	777130	IMPULSOR IMPELLER
4	REC909753	909753	EJE CORTO BOMBA SHORT DRIVE SHAFT
	REC908087	908087	EJE LARGO BOMBA LONG DRIVE SHAFT
5	REC125017	302540	ANILLO GOMA (ANTIGUO) O-RING (EARLY MODEL)
6	REC3855081	311598	JUNTA GASKET
7	REC308768	308768	RETÉN SEAL
8	REC907774	097774	RETÉN SEAL
9	REC981196	981196	RETÉN SEAL
10	REC981268	981268	RETÉN SEAL
11	REC907866	907866	TUERCA NUT
12	REC908064	908064	TUERCA NUT
13	REC908062	908062	TAPA COVER
14	REC308592	308592	JUNTA GASKET
15	REC315189	315189	JUNTA GASKET

	REF	OEM		
1	PAGB/T848-6	305981	ARANDELA	O-RING
2	REC321467	321467	RETÉN	OIL SEAL
3	REC387817	387817	COJINETE	PINION BEARING
4	REC338484	910338	JUNTA GM 4 CIL.	GASKET
5	REC983494AL	983494	ANODO	ANODE
6	REC3855081	311598	JUNTA	GASKET
7	REC436745AL	436745	ANODO	ANODE
8	REC331880	331880	PASADOR	PIN
9	REC313446	313446	ARO 4 CIL.	O-RING
10	REC387247	387247	COJINETE	BEARING
11	REC26-76868	320862	RETÉN	OIL SEAL
	REC330137	330137	RETÉN 4 CIL.	OIL SEAL
12	REC431708AL	431708	ANODO	ANODE
13	REC398042	398042	TUERCA (800)	NUT
14	REC324670	324670	JUNTA	GASKET

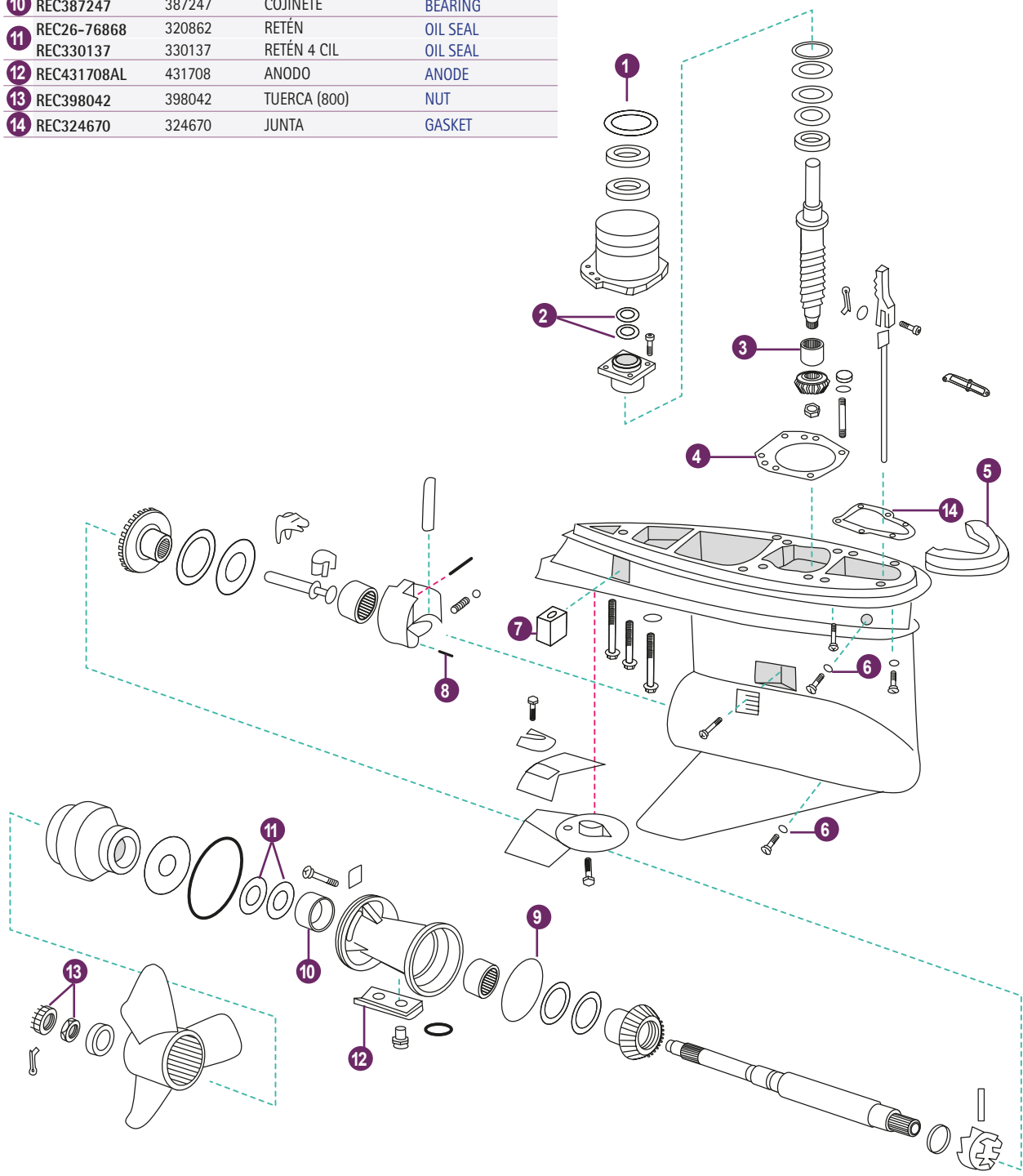

TRANSOM
COBRA (1986-93)

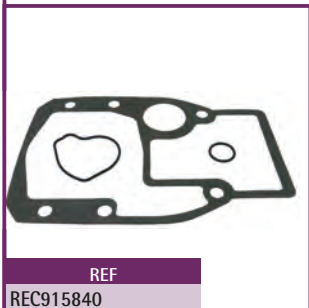

REF
REC915840

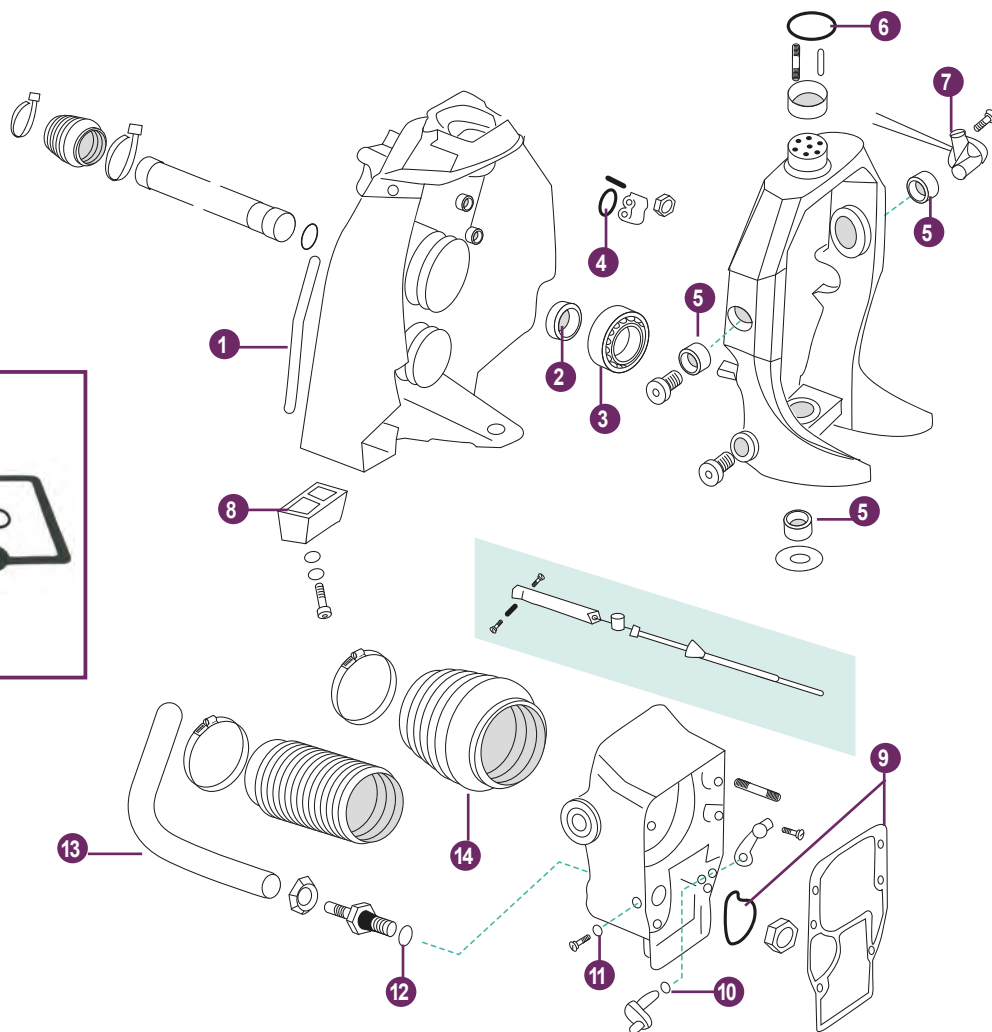

	REF	OEM		
1	REC3852550	3852550	JUNTA TRANSOM	GASKET
2	REC3852548	3852548	RETÉN TRASERO	REAR SEAL
3	REC30-879194A01	3853807	COJINETE TRANSOM	GIMBAL BEARING
4	REC331188	322501	ARO	O-RING
5	REC3808228	3852544	CASQUILLO	PIVOT PIN BEARING
6	REC25-33145	302337	ARO	O-RING
7	RM3850470	3850470	SENSOR TRIM	TRIM SONDE
8	TEN00919	3853930	ANODO	ANODE
9	REC915840	915840	KIT DE JUNTAS	GASKET SET
10	REC25-48171	202893	ARO TORICO	O-RING
11	REC332583	911311	ARO	O-RING
12	REC3852535	911718	ARO	O-RING
13	REC3852352	911830	TUBO SUBIDA AGUA	TRIM HOSE UP
14	REC3841481	3854127	FUELLE CARDAN	BELLOU, U-JOINT

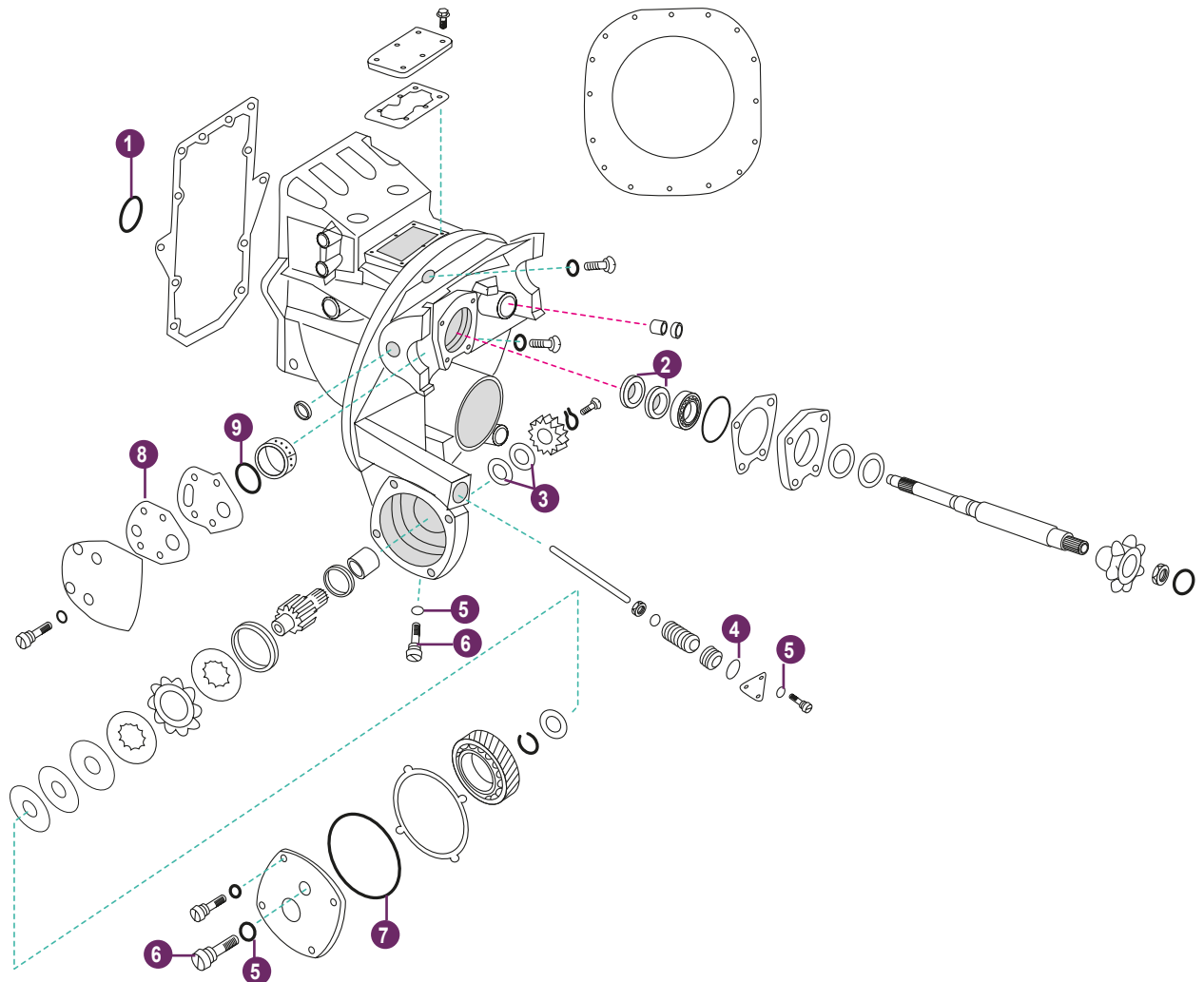

	REF	OEM		
1	REC25-33145	302337	ARO GOMA	O-RING
2	REC26-419533	764337	RETÉN	OIL SEAL
3	REC321467	321467	RETÉN	OIL SEAL
4	REC125017	302540	ARO	O-RING
5	REC3855081	311598	JUNTA	GASKET
6	REC10-79953Q04	307551	TORNILLO	SCREW
7	REC908194	908194	ARO GOMA	O-RING
8	REC323338	316499	JUNTA CAMBIO ELECTRÓNICO	ELEC. SHIFT GASKET
9	REC25-457101	308626	ARO GOMA	O-RING

KITS REPARACIÓN

REPAIR KITS

COLAS

DRIVES

REF	OEM
REC915840	915840



EJES BOMBA AGUA

WATER PUMP SHAFT

REF	OEM
REC909753	909753
REC908087	908087



JUNTAS

GASKETS

CIERRE COBRA

OUTDRIVE SEAL COBRA

REF	OEM
REC3852560	3852560



SALIDA AGUA

WATER OUTLET

REF	OEM
REC27-8146801	311069 3789161GM



CAMBIO MECÁNICO

SWIVEL BRG. MECH SHIFT

REF	OEM
REC338484	910338 324701 338484



GOMA TRANSOM

TRANSOM GASKET

REF	OEM	
REC313080	0313080, 313080	 (1967-77) 120 HP+



JUNTAS DE DRENAJE

DRAIN GASKET

REF	OEM	
REC947084	947084	19 x 12,70 x 1,5 mm



JUNTA TAPA DE AGUA

COVER GASKET

REF	OEM
REC308592	0308592



RETENES

SEALS

GUÍA AROS TÓRICOS

O'RING GUIDE

REF.	OEM	Ø INT	Ø EXT	GRUESO THICK
REC25-48171	202893	3/8	1/2	1/16
REC25-33145	302337	2	2 ^{1/4}	1/8
REC125017	302540	1	1 ^{1/4}	1/8
REC302588	302588	1 ^{3/4}	2	1/8
REC3852045	303067	3/8	9/16	3/32
REC25-62702	303191	5/16	7/16	1/16
REC303347	303347	7/16	5/8	3/32
REC25-35027	303360	1 ^{1/16}	1 ^{5/16}	1/8
REC305242	305242	5/16	9/16	1/8
REC332583	305739	1/4	3/8	1/16
REC25-457101	308626	1 ^{7/16}	1 ^{5/8}	3/32
REC308627	308627	2 ^{1/4}	2 ^{1/2}	1/8
REC308876	308876	2 ^{1/4}	2 ^{7/16}	3/32
REC310414	310141	3 ^{5/8}	3 ^{7/8}	1/8
REC25-30224	310327	1 ^{7/8}	2 ^{1/8}	1/8
REC310414	310414	3 ^{5/8}	3 ^{7/8}	1/8
REC25-30613	310585	3/4	1 ^{5/16}	3/32
REC25-30613	310967	3/4	1 ^{5/16}	3/32
REC967344	313446	3 ^{3/8}	3 ^{5/8}	1/8
REC332583	317178	1/4	3/8	1/16
REC318372	318372	8 mm	16 mm	4 mm
REC925093	320303	2 ^{3/4}	3	1/8
REC331188	322501	1 ^{5/16}	1 ^{1/2}	3/32
REC3852045	329381	3/8	9/16	3/32
REC332583	332583	1/4	3/8	1/16
REC332583	332584	1/4	3/8	1/16
REC338518	338518	2 ^{9/16}	2 ^{3/4}	3/32
REC25-25439	3852565	7/8	1 ^{1/16}	3/32
REC908194	908194	4	4 ^{3/16}	3/32
REC909316	909316	1 ^{1/2}	1 ^{11/16}	3/32
REC3852045	909747	5/16	1/2	3/32
REC25-30224	910582	1 ^{7/8}	2 ^{1/8}	1/8
REC332583	911311	1/4	3/8	1/16
REC25-70937	911686	3 ^{1/2}	3 ^{3/4}	1/8
REC911700	911700	4 ^{1/8}	4 ^{3/8}	1/8
REC3852535	911718	1 ^{1/16}	1 ^{1/4}	3/32

REF.	OEM	Ø INT	Ø EXT	GRUESO THICK
REC25-35029	25-35029 35029 802231 882613	31/8	33/8	1/8
REC25-62705	25-62705 25-8M0204667 62705 8M0204667 F748342	3/4	7/8	1/16
REC301877	25-85594 85594	31/128	73/128	21/128
REC301967		13/16	1	3/32
REC302537		13/8	19/16	3/32
REC304174		1/2	5/8	1/16
REC305123		33/4	4	1/8
REC302035	25-48452	7/16	9/16	1/16
REC310584		3/4	1	1/8
REC313175		43/4	5	1/8
REC313754		21/16	21/16	3/32
REC314491		1	11/8	1/16
REC314728		21/8	25/16	3/32
REC318717		11/2	1 7/8	3/16
REC319085		11/8	11/2	3/16
REC326649		5/8	13/16	3/32
REC326849		41/4	41/2	1/8
REC339543		1/2	11/16	3/32
REC3852928	25-26855 26855	15/8	17/8	1/8
REC553126	25-31305 31305	31/4	31/2	1/8
REC909048	802149	1/2	11/16	3/32
REC909139	802149	1	11/4	1/8
REC909140	25-58390 58390	11/16	113/16	1/16
REC910238	802151 802383	51/4	51/2	1/8

GUÍA RETENES ACEITE

OIL SEAL GUIDE

REF.	OEM	EJE SHAFT SIZE	CALIBRE BORE SIZE
REC26-419533	313392	1.1875	1.8750
REC318972	318972	0.50000	0.8750
REC29-47270	318972	0.5000	0.8750
REC26-76868	320862	1.1875	1.6875
REC26-69188	321453	0.8750	1.2500
REC321459	321459	0.6250	1.1250
REC321466	321466	0.7500	1.1250
REC321467	321467	1.0000	1.3750
REC321480	321480	0.5000	1.2500
REC321481	321481	0.6875	1.2500
REC321895	321895	1.6250	1.9219
REC321928	321928	0.6250	1.3750
REC324639	324639	0.4375	0.9375

REF.	OEM	EJE SHAFT SIZE	CALIBRE BORE SIZE
REC327031	327031	0.4375	0.8750
REC26-76868	3286	1.1875	1.6875
REC329922	329922	0.8750	1.3750
REC329923	329923	0.8750	1.3750
REC330137	330137	1.2500	1.6250
REC342786	332205	0.7500	1.1250
REC332261	332261	0.6250	1.3750
REC334950	334950	1.2500	1.6875
REC3852272	3852272	45 mm	75 mm
REC3853655	3853655	0.5000	0.9062
REC853868	3853858	25 mm	35 mm
REC911685	911685	2.0000	2.5000

OMC



**APLICACIÓN DE RETENES
COBRA**







COBRA SEALS APPLICATIONS

		REF			CANTIDAD QUANTITY
TRANSOM					
262 - 460	1988-90	REC3852548	EJE	DRIVESHAFT	1
PARTE SUPERIOR UPPER GEARCASE					
262 - 460	1988-90	REC911685	COJINETE	BEARING CARRIER	1
350 - 460	1988-90	REC3853655	EJE BOMBA	PUMP SHAFT	1
2.3 L - 7.5 L	1986-88	REC3853655	EJE BOMBA	PUMP SHAFT	1
2.3 L - 7.5 L 5.7 L (1990) 574 AMPWS, ARPWS	1986-90	REC911685	COJINETE	BEARING CARRIER	1
PARTE INFERIOR LOWER GEARCASE					
262 - 460	1988-89	REC26-76868	EJE HÉLICE	PROP SHAFT	2
2.3 L	1990	REC330137	EJE HÉLICE	PROP SHAFT	2
2.3 L - 3.0 L	1986-89	REC330137	EJE HÉLICE	PROP SHAFT	2
3.0 L	1990	REC26-76868	EJE HÉLICE	PROP SHAFT	2
4.3 L - 7.5 L	1986-90	REC26-76868	EJE HÉLICE	PROP SHAFT	2

GUIA CORREAS

V-BELTS GUIDE

	BOMBA AGUA WATER PUMP	DIRECCIÓN HIDRAULICA POWER STEERING	ALTER. ALTER.	REF	OEM
120, 140, 145, 165, 170, 175, 190, 235, 240	✓		✓	REC3852106	311606
4 151 					
140	✓		✓	REC829207	310953
155, 185, 210, 215, 225, 230, 235, 240, 245, 250, 260 V-6, V-8	✓		✓	REC3858462	311046
165 1972-76	✓		✓	REC3852106	311606
165C, 165S 40-1/4"	✓		✓	REC3858462	
165C, 165S 43-3/4"	✓		✓	REC966382	
170 1974	✓		✓	REC3852106	311606
175 1975-77	✓		✓	REC3852106	311606
	✓		✓	REC3858462	311046
185 1978-84	✓	✓	✓	REC829207	909971
	✓	✓	✓	REC829207	909971
190 1974-77	✓		✓	REC3852106	311606
190, 225 44-1/4"	✓			REC3858462	
	✓		✓	REC3858462	311046
200 1979-81	✓	✓	✓	REC829207	909971
	✓	✓	✓	REC829207	909971
210 1970-71	✓		✓	REC3858462	311046
215 V-8	✓		✓	REC966382	
302 Ford 	✓		✓	REC3858462	311046
225 1972-84	✓		✓	REC3858462	311046
250 1973	✓		✓	REC3858462	311046
	✓		✓	REC3858462	311046
	✓	✓	✓	REC829207	909971
230, 260	✓	✓	✓	REC829207	909971
	✓		✓	REC3858462	311046
1975	Salada Sea			REC3852464	3852464
235 1971	✓		✓	REC3858462	311046
1975-77	✓		✓	REC3852106	311606
240 1975-84	✓		✓	REC3852106	311606
250 1979	✓		✓	REC3852106	311606
245 Jet Drive	✓		✓	REC3852106	311606
262 King Cobra 4.3L (V-6 262)	✓		✓	REC57-48122Q	3852504
1989	✓		✓	REC3852106	311606
	✓	✓		REC3852464	3852464

	BOMBA AGUA WATER PUMP	DIRECCIÓN HIDRAULICA POWER STEERING	ALTER. ALTER.	REF	OEM
290 Jet Drive 1974-75	✓		✓	REC3858462	311046
	✓		✓	REC3858462	311046
305 V-8 305 	46" Salada Sea			REC3852464	3852464
325 390 V-8 427			✓	REC57-48122Q	
	✓		✓	REC3858462	311046
350 V-8 350 	46" Salada Sea			REC3852464	3852464
350 King Cobra 5.7L (V-8 350)	✓		✓	REC3852464	3852464
1988 	✓	✓	✓	REC57-48122Q	3852504
370 V-8 454 	Salada Sea		✓	REC57-78200Q1	3852504
	✓		✓	REC57-48122Q	3852504
454 V-8 454 	1977-82		✓	REC3852464	3852464
454 King Cobra V-8 454 	Salada Sea		✓	REC57-78200Q1	3852504
	✓		✓	REC57-48122Q	3852504
460 King Cobra 7.5L (V-8 460)	1988		✓	REC829207	909971
	✓	✓		REC57-34359	912714
888 V-8 427	✓		✓	REC966382	
2.3L "4" 140	✓		✓	REC966382	912509
	✓	✓		REC966382	912509
3.8L (V-6 229)	✓		✓	REC57-48122Q	3852504
4.3L (V-6 262)	✓		✓	REC3852106	311606
3.8L (V-6 229) (1982-86)	✓		✓	REC3852106	311606
4.3L (V-6 262) (1982-89)	✓	✓		REC3852464	3852464
5.0L (V-8 305)	✓		✓	REC3852464	3852464
5.7L (V-8 350)	✓	✓	✓	REC57-48122Q	3852504
5.0L (V-8 305) (1982-87)	✓		✓	REC3852464	3852464
5.7L (V-8 350) (1982-90)	✓	✓		REC3852464	3852464
5.0L (V-8 302)	✓		✓	REC3852106	311606C
5.7L (V-8 351)	✓		✓	REC3858462	3858462
5.0L (V-8 305) (1988)	✓	✓	✓	REC3858462	3858462
5.8L (V-8 351)	✓		✓	REC829207	909971
7.5L (V-8 460)	1987	✓	✓	REC57-34359	912714

COMPONENTES DE COLA

GEARHOUSING COMPONENTS

FUELLES ESCAPE

EXHAUST BELLOWS

REF	OEM	
REC3863450	3852741	2.5 1986
		3.0 1986-91
		2.3 1989-90
		4.3 1990-91
		5.0-5.8 Ford 1991
		5.7 1986.



REF	OEM	
REC3852742	3852742	2.3/4.3/5.0/5.7/5.8L (1989-91)
		2.3 1987-88,
		4.3 1987-89,
		5.0-5.8 Ford 1989-90,
		5.7 1986,
		5.7 1987-91, 1990-91 (350/454/454HO/460 King, 5.7LE 1990-91.

Manguito inferior
Lower hose



REF	OEM	
REC3852696	3852696	4.3 1991, 5.0-5.8 Ford 1991, 7.5 (460) 1988-89, 5.7LE 1990-91



EJES TRANSMISIÓN

DRIVES SHAFTS

REF	OEM
REC909121	909121



CRUCETAS CARDAN

U-JOINTS

REF	OEM
REC75832T	912214



REF	OEM
REC3850812	3850812

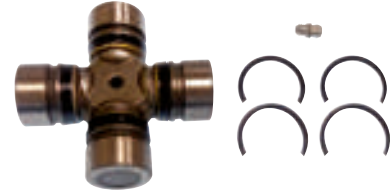

EJE HÉLICE CAMBIO MECÁNICO

PROP SHAFT MECHANICAL SHIFT

4 CYL	V6-V8	REF	OEM		
✓		REC330137	330137	RETEN ACEITE EJE HELICE	OIL SEAL - PROP SHAFT
	✓	REC26-76868	320862	RETEN ACEITE EJE HELICE	OIL SEAL - PROP SHAFT
	✓	REC387247	387247	COJINETE ACEITE EJE HELICE	BEARING - PROP SHAFT
✓		REC967344	313446	ARO TÓRICO	O-RING



REC330137



REC26-76868



REC967344



REC387247

HERRAMIENTAS COLAS

STERNDRIVES TOOLS

ALINEACIÓN MOTOR

ENGINE ALIGNMENT TOOL

REF	OEM
REC91-805475A1	912273



CIERRE DE HÉLICE

PROP HARDWARE

PASADOR

COTTER PIN

REF	OEM
REC306376	0306376 306376
REC314502	0314502 314502



GUÍA RETENES ACEITE

OIL SEALS GUIDE

REF	OEM	CALIBRE CALIBER (")	Ø EJE SHAFT Ø (mm)	EJE SHAFT
REC314167	0314167 314167	0.9375	0,4219	0.4375
REC302564	0302564 0313258 302564	1.3750	0,7813	0.75
REC303345	0303345 303345	1.0000	0,5625	0.5625
REC321786	0321786 321786	1.1250	0,625	0.625
REC321831	0321831 321831	1.2500	0,75	0.75



OEM --> REF

OEM	REF		OEM	REF		OEM	REF	
10-861788	REC10-861788	512	318972	REC318972	547	3852687	REC17931	523-526
1114356	REC13037	513	320303	REC925093	547	3852693	REC17900	521
120177	REC13-35048	529-530-531-532-533	320862	REC26-76868	543-547-549	3852696	REC3852696	531-532-533-549
171960	REC97258A1	510	320936	REC305762	516	3852741	REC3863450	530-531-532-533-549
173834	REC35-06004	506	321453	REC26-69188	547	3852742	REC3852742	532-549
174796	REC3517857	506	321459	REC321459	547	3852830	REC3852830	531-532-533
20223	REC3854311	519	321466	REC321466	547	3852865	REC3852865	541
202893	REC25-48171	544-547	321467	REC321467	543-545-547	3852866	REC3852866	541
21533394	REC21533394	508	321480	REC321480	547	3853155	REC10-37612	533
25-26855	REC3852928	547	321481	REC321481	547	3853283	REC3853283	508
25-31305	REC553126	547	321786	REC321786	550	3853326	REC10-37612	533
25-35029	REC25-35029	547	321831	REC321831	550	3853336	REC17000	520-521
25-48452	REC302035	547	321895	REC321895	547	3853343	REC17950	520
25-58390	REC909140	547	321928	REC321928	547	3853380	REC17020	523
25-62705	REC25-62705	547	322501	REC331188	544-547	3853380	REC17030	524
25-85594	REC301877	547	324639	REC324639	547	3853404	REC46335	531-532-533
25-8M0204667	REC25-62705	547	324670	REC324670	543	3853412	REC27-99757	522-531
26855	REC3852928	547	324701	REC338484	546	3853434	REC3853434	533
302337	REC25-33145	544-545-547	327031	REC327031	547	3853513	REC17937	527
302540	REC125017	542-545-547	3286	REC26-76868	547	3853548	REC1463-9382	517
302564	REC302564	550	329381	REC3852045	547	3853655	REC3853655	537-547
302588	REC302588	547	329922	REC329922	547	3853787	REC806490T	510
303067	REC3852045	537-540-547	329923	REC329923	547	3853799	REC3853799	515
303191	REC25-62702	547	330137	REC330137	539-543-547-549	3853807	REC30-879194A01	544
303345	REC303345	550	331880	REC331880	539-543	3853815	REC392-9766	518
303347	REC303347	547	332205	REC342786	547	3853850	REC46-8M0113734	534
303360	REC25-35027	547	332261	REC332261	547	3853854	REC3853854	514
304027	REC304027	516	332583	REC332583	547	3853855	REC3853855	514
305242	REC305242	547	332584	REC332584	547	3853856	REC3853856	514
305282	REC305282	516	333572	REC3855081	540-541	3853857	REC3853857	514
305739	REC332583	547	334950	REC334950	539-547	3853858	REC853868	547
305762	REC305762	516	337778	REC337778	538	3853930	REC986158	535
305981	PAGB/T848-6	538-543	338484	REC338484	546	3853930	REC986158AL	535
306325	REC13-39107	532	338518	REC338518	547	3853945	REC382138	513
306376	REC306376	550	345419	REC0586180	513	3853945	REC3853945	513
306405	REC13-35048	532-533	35029	REC25-35029	547	3853983	REC3853983	515
306422	REC3852142	529-530	351325	REC3863191	531	3854001	REC3854001	518
306470	REC13-39107	529-530	3789161GM	REC27-8146801	546	3854002	REC3854002	517
307551	REC10-79953Q04	545	380541	REC393-9459Q1	518	3854003	REC3854003	518
308592	REC308592	542-546	38071	REC3854549	519	3854020	REC3854020	508
308626	REC25-457101	545-547	381690	REC35-49088A2	506	3854061	REC987067	535
308627	REC308627	547	382133	REC12532	519	3854061	REC987067AL	535
308768	REC308768	542	383622	REC0586180	513	3854127	REC3841481	544
308876	REC308876	547	383918	REC823426A1	507	3854159	REC3854159	510
309336	REC13-35048	532	384743	REC823426A1	507	3854161	REC3854161	517
310141	REC310414	547	3850360	REC3850360	515	3854190	REC3854190	512
310327	REC25-30224	547	3850396	REC3850396	510	3854194	REC0987883	511
310327	REC25-30224	542	3850470	RM3850470	514-544	3854217	REC3854217	518
310414	REC310414	547	3850495	REC3850495	529-530	3854260	REC3854260	518
310585	REC25-30613	547	3850812	REC3850812	537-540-549	3854261	REC3854261	519
310953	REC829207	548	3850853	REC183247	540	3854299	REC17010	521
310967	REC25-30613	547	3852217	REC300-00879	517	3854300	REC17920	522
311046	REC3858462	548	3852272	REC3852272	540-547	3854331	REC3854331	519
311068	REC27-52546	529	3852279	REC3852279	540	3854347	REC3854020	508
311069	REC27-8146801	546	3852308	REC967344	540	3854402	REC854040	541
311598	REC3855081	538-542-543-545	3852315	REC3852315	541	3854548	REC3854548	519
311606	REC3852106	548	3852317	REC3852317	540	3854620	REC3858261	506
311606C	REC3852106	548	3852455	REC3852455	533-534	3854942	REC17921	522
312456	REC35-49088A2	506	3852464	REC3852464	548	3855184	REC8M0125617	510
312781	REC32-33189	534	3852467	REC3852467	531-532	3855411	REC3855411	535
31305	REC553126	547	3852468	REC27-33395	532	3855411	REC3863193AL	535
313080	REC313080	546	3852472	REC27-46820	527-533	3856008	REC3856008	540
313176	REC313176	516	3852476	REC3852476	534	3856138	REC17982	523-525
313258	REC302564	550	3852504	REC57-48122Q	548	3856443	REC17903	521
313392	REC26-419533	547	3852504	REC57-78200Q1	548	3857532	REC8M0068784	510
313446	REC313446	543	3852538	REC3852538	531-532-533	3857533	REC3857533	513
313446	REC967344	539-547-549	3852544	REC3808228	544	3857986	REC3858261	506
314167	REC314167	540	3852548	REC3852548	544	3858261	REC3858261	506
314502	REC314502	550	3852550	REC3852550	544	3858340	REC46-8M0113733	534
314616	REC16-70236	530	3852560	REC3852560	540-546	3858462	REC3858462	548
315189	REC315189	542	3852561	REC3589522	537-540	3860566	REC50-863007A1	512
316499	REC323338	545	3852562	REC3589524	537-540	3860566	REC50-99418A2	512
317178	REC332583	547	3852565	REC25-25439	537-540-547	3862500	REC3862500	531-532
318372	REC318372	538-547	3852568	REC3852568	516	3863090	REC3863090	541
318972	REC29-47270	547	3852655	REC17971	522	3863191	REC3863191	532-533

OEM	REF		OEM	REF		OEM	REF	
387247	REC387247	539-543-549	882613	REC25-35029	547	982187	REC3853839	513
387277	REC0584107	513	897816	REC3856008	540	982202	REC50-97499A2	511
387817	REC387817	543	8M0204667	REC25-62705	547	982215	REC1347-816373A4	507
391264	REC0393988	513	907866	REC907866	542	982223	REC1347-816373A4	507
393259	REC0393988	513	908062	REC908062	542	982240	REC86234A4	507
393988	REC0393988	513	908064	REC908064	542	982384	REC823427A1	507-508
394176	REC0393988	513	908079	REC27-53354	530	982438	REC982438AL	535
396355	REC305762	516	908087	REC908087	542-546	982438	REC1396-4656	508
397768	REC397768	535	908194	REC908194	545-547	982537	REC1396-4656	508
397768	REC397768AL	535	908611	REC17000	520-521	982538	REC1396-5238	508
398042	REC398042	543	908700	REC46335	532	982539	REC0982706	514
423-6349	REC423-6349	519	909121	REC909121	542-549	982706	REC982997	507
431708	REC431708	535-539-543	909316	REC909316	537-547	982997	REC0393988	513
431708	REC431708AL	535-539-543	909747	REC3852045	547	983019	REC841994	508
436745	REC436745	535-538-543	909753	REC909753	542-546	983073	REC879031	516
436745	REC436745AL	535-538-543	909758	REC27-8079821	508	983218	REC983494AL	535-538-543
439967	REC439967	539	909829	REC3852476	534	983494	REC1347-816373A4	507
5006561	REC5006561	509	909971	REC829207	548	983494	REC823426A1	507
5008966	REC398042	539-541	910338	REC338484	543-546	983855	REC983878	537
502900	REC35-06007	506	910582	REC25-30224	542-547	983864	RM3850470	514
502903	REC35-06004	506	910953	REC3852165	540	983878	REC983952	535
502904	REC3517857	506	910953	RM3852516	537	983939	REC983952AL	535
5032542	REC55125-90J01	535	911311	REC332583	544	983952	REC439967	539
5032929	REC55125-90J01	535	911678	REC911678	537	983952	REC841994	508
503748	REC15-405	518	911679	REC911679	537	984458	REC0984536	511
503748	REC15-602	518	911680	REC911680	537	984487	REC983952	535
503750	REC15-601	518	911681	REC911681	537	984536	REC983952AL	535
503751	REC15-806	518	911685	REC911685	537-547	984547	REC0984628	511
503752	REC15-801	518	911686	REC25-70937	537-547	984547	RM3850470	514
503752	REC15-806	518	911698	REC911698	537	984628	REC984744	537-538
503753	REC15-811	518	911700	REC911700	537-547	984731	REC50-808011A05	511
503753	REC15-805	518	911702	REC802385	537	984744	REC3853839	513
503754	REC15-801	518	911703	REC911703	537	984982	REC0393988	513
503754	REC15-806	518	911704	REC911704	537	985063	REC46-8M0113734	534
503755	REC15-801	518	911705	REC911705	538	985237	REC86234A4	507
503755	REC15-806	518	911718	REC3852535	544-547	985429	REC86234A4	507
503755	REC15-811	518	911830	REC3852352	544	985602	REC1347-816373A4	507
508459	REC1397-6367A1	508	911859	REC3852568	516	985603	REC3860769	512
509282	REC32-8M0071007	534	911878	REC911878	538	985822	REC3860769	512
552938	REC11-862903	529-530	912214	REC75832T	537-549	985964	REC382138	513
582048	REC0584107	513	912273	REC91-805475A1	549	986008	REC3853945	513
582155	REC0584107	513	912477	REC878982	534	986280	REC3850360	515
582708	REC0586180	513	912509	REC966382	548	986280	REC3854001	518
58390	REC909140	547	912714	REC57-34359	548	986292	REC3854003	518
586180	REC0586180	513	913784	REC3863191	534	986642	REC3854020	508
62705	REC25-62705	547	915719	REC915719	538	986650	REC21533394	508
764197	REC764197	537-538	915840	REC915840	537-544-546	986796	REC21533394	508
764337	REC26-419533	545	925093	REC925093	540	987438	REC21533394	508
764799	REC764799	532-534	947084	REC947084	546	987440	REC21533394	508
769674	REC3852568	516	951924	REC951924	540	987485	REC3850360	515
777128	REC777128	537	976669	REC976669	535	987716	REC3854190	512
777130	REC777130	542	976669	REC976669AL	535	987811	REC0984536	511
778864	REC35-06003	506	97774	REC907774	542	988013	REC50-806965A4	512
802149	REC909048	547	979659	REC823426A1	507	988217	REC50-99417A2	511
802149	REC909139	547	981078	REC50-99417A2	511	988217	REC69729	512
802151	REC909140	547	981196	REC981196	542	988247	REC25-62705	547
802231	REC25-35029	547	981268	REC981268	542	F748342		
802383	REC910238	547	981288	REC50-808011A05	511			
802416	REC984491	506	981289	REC50-97499A2	511			
814603	RM385602	540	981359	REC1347-816373A4	507			
835096	REC17930	523-524-526	981428	REC1347-816373A4	507			
853858	REC853868	540	981564	REC1347-816373A4	507			
855729	REC17980	523-524-525	981650	REC3855276	507			
85594	REC301877	547	981705	REC1347-816373A4	507			
856034	REC27-33395	523	981803	REC1347-816373A4	507			
856365	REC17320	523	982058	REC0982706	514			
856626	REC17935	527	982063	REC62092T	507			
857177	REC17310	522	982121	REC50-99417A2	511			

REF --> OEM

REF	OEM	
P		
PAGB/T848-6	305981	538-543
R		
REC0393988	391264	513
REC0393988	393259	513
REC0393988	393988	513
REC0393988	394176	513
REC0393988	983019	513
REC0393988	985237	513
REC0584107	387277	513
REC0584107	582048	513
REC0584107	582155	513
REC0586180	345419	513
REC0586180	383622	513
REC0586180	582708	513
REC0586180	586180	513
REC0982706	982058	514
REC0982706	982706	514
REC0984536	984536	511
REC0984536	988013	511
REC0984628	984628	511
REC0987883	3854194	511
REC10-37612	3853155	533
REC10-37612	3853326	533
REC10-79953Q04	307551	545
REC10-861788	10-861788	512
REC11-862903	552938	529-530
REC12092		516
REC125017	302540	542-545-547
REC12532	382133	519
REC13-35048	120177	529-530-531-532-533
REC13-35048	306405	532-533
REC13-35048	309336	532
REC13-39107	306325	532
REC13-39107	306470	529-530
REC13037	1114356	513
REC13430		515
REC1347-816373A4	981359	507
REC1347-816373A4	981428	507
REC1347-816373A4	981564	507
REC1347-816373A4	981705	507
REC1347-816373A4	981803	507
REC1347-816373A4	982215	507
REC1347-816373A4	982223	507
REC1347-816373A4	983855	507
REC1347-816373A4	985822	507
REC1396-4656	982537	508
REC1396-4656	982538	508
REC1396-4656		509
REC1396-5238	982539	508-509
REC1397-6367A1	508459	508
REC1463-9382	3853548	517
REC15-401		518
REC15-405	503748	518
REC15-601	503750	518
REC15-602	503748	518
REC15-604		518
REC15-801	503752	518
REC15-801	503755	518
REC15-801		518
REC15-801	503754	518
REC15-805	503753	518
REC15-806	503751	518
REC15-806	503752	518
REC15-806	503754	518
REC15-806	503755	518
REC15-811	503752	518
REC15-811	503755	518
REC16-70236	314616	530
REC17000	908611	520-521
REC17000	3853336	520-521
REC17010	3854299	521
REC17020	3853380	523
REC17030	3853380	524-525
REC17040		526

REF	OEM	
REC17042		526
REC17048		527
REC17100		520-521
REC17102		521
REC17110		522
REC17116		522
REC17120		523-524-525
REC17125		523-525
REC17140		526-528
REC17146		524-527-528
REC17200		520-521
REC17207		528
REC17210		521
REC17211		522
REC17214		525
REC17220		523
REC17224		523
REC17230		524-525
REC17232		525
REC17240		526
REC17241		526
REC17242		526
REC17243		526
REC17248		527
REC17310	857177	522
REC17320	856365	523-524-525
REC17340		527
REC17341		527-528
REC17342		527
REC17900	3852693	521
REC17903	3856443	521
REC17920	3854300	522
REC17921	3854942	522
REC17930	835096	523-524-526
REC17931	3852687	523-526
REC17935	856626	527-528
REC17937	3853513	527-528
REC17950	3853343	520-521
REC17970		522
REC17971	3852655	522
REC17980	855729	523-524-525
REC17981		523-525
REC17982	3856138	523-525
REC17986		528
REC183247	3850853	540
REC21533394	987438	508
REC21533394	987440	508
REC21533394	987485	508
REC21533394	21533394	508
REC21533394		509
REC25-25439	3852565	537-540-547
REC25-30224	310327	547
REC25-30224	910582	542-547
REC25-30224	310327	542
REC25-30613	310585	547
REC25-30613	310967	547
REC25-33145	302337	544-545-547
REC25-35027	303360	547
REC25-35029	35029	547
REC25-35029	802231	547
REC25-35029	882613	547
REC25-35029	25-35029	547
REC25-457101	308626	545-547
REC25-48171	202893	544-547
REC25-62702	303191	547
REC25-62705	62705	547
REC25-62705	25-62705	547
REC25-62705	25-8M0204667	547
REC25-62705	8M0204667	547
REC25-62705	F748342	547
REC25-62705		547
REC25-70937	911686	537-547
REC26-14756		527-528

REF	OEM	
REC26-419533	313392	547
REC26-419533	764337	545
REC26-69188	321453	547
REC26-76868	3286	547
REC26-76868	320862	543-547-549
REC26-76868		548
REC27-33395	856034	523
REC27-33395	3852468	532
REC27-46820	3852472	527-528-533
REC27-52546	311068	529
REC27-53354	908079	521-530
REC27-8079821	909758	508
REC27-8146801	311069	546
REC27-8146801	3789161GM	546
REC27-96429		520-521
REC27-99757	3853412	522-531
REC29-47270	318972	547
REC30-879194A01	3853807	544
REC300-00879	3852217	517
REC301877	85594	547
REC301877	25-85594	547
REC301967		547
REC302035	25-48452	547
REC302537		547
REC302564	302564	550
REC302564	313258	550
REC302588	302588	547
REC303345	303345	550
REC303347	303347	547
REC304027	304027	516
REC304174		547
REC305123		547
REC305242	305242	547
REC305282	305282	516
REC305762	305762	516
REC305762	320936	516
REC305762	396355	516
REC306376	306376	550
REC308592	308592	542-546
REC308627	308627	547
REC308768	308768	542
REC308876	308876	547
REC310414	310414	547
REC310414	310414	547
REC310584		547
REC313080	313080	546
REC313175		547
REC313176	313176	516
REC313446	313446	543
REC313754		547
REC314167	314167	550
REC314491		547
REC314502	314502	550
REC314728		547
REC315189	315189	542
REC318372	318372	538-547
REC318717		547
REC318972	318972	547
REC319085		547
REC32-33189	312781	534
REC32-8M0071007	509282	534
REC321459	321459	547
REC321466	321466	547
REC321467	321467	543-545-547
REC321480	321480	547
REC321481	321481	547
REC321786	321786	550
REC321831	321831	550
REC321895	321895	547
REC321928	321928	547
REC323338	316499	545
REC324639	324639	547
REC324670	324670	543
REC326649		547
REC326849		547

REF	OEM	
REC327031	327031	547
REC329922	329922	547
REC329923	329923	547
REC330137	330137	539-543-547-548-549
REC331188	322501	544-547
REC331880	331880	539-543
REC332261	332261	547
REC332583	305739	547
REC332583	317178	547
REC332583	332583	547
REC332583	332584	547
REC332583	911311	544
REC334950	334950	539-547
REC337778	337778	538
REC338484	324701	546
REC338484	338484	546
REC338484	910338	543-546
REC338518	338518	547
REC339543		547
REC342786	332205	547
REC35-06003	778864	506
REC35-06004	173834	506
REC35-06004	502903	506
REC35-06007	502900	506
REC35-49088A2	312456	506
REC35-49088A2	381690	506
REC3517857	174796	506
REC3517857	502904	506
REC3589522	3852561	537-540
REC3589524	3852562	537-540
REC3808228	3852544	544
REC382138	986280	513
REC382138	3853945	513
REC3841481	3854127	544
REC3850360	986292	515
REC3850360	987716	515
REC3850360	3850360	515
REC3850396	3850396	510
REC3850495	3850495	529-530
REC3850812	3850812	537-540-549
REC3852045	303067	537-540-547
REC3852045	329381	547
REC3852045	909747	547
REC3852106	311606	548
REC3852106	311606C	548
REC3852142	306422	529-530
REC3852165	910953	540
REC3852272	3852272	540-547
REC3852279	3852279	540
REC3852315	3852315	541
REC3852317	3852317	540
REC3852352	911830	544
REC3852455	3852455	522-524-528-533-534
REC3852464	3852464	548
REC3852467	3852467	531-532
REC3852476	909829	534
REC3852476	3852476	534
REC3852535	911718	544-547
REC3852538	3852538	531-532-533
REC3852548	3852548	544-548
REC3852550	3852550	544
REC3852560	3852560	540-546
REC3852568	769674	516
REC3852568	911859	516
REC3852568	3852568	516
REC3852696	3852696	531-532-533-549
REC3852742	3852742	532-549
REC3852830	3852830	531-532-533
REC3852865	3852865	541
REC3852866	3852866	541
REC3852928	26855	547
REC3852928	25-26855	547
REC3853283	3853283	508
REC3853341		522-524-526
REC3853434	3853434	533

REF	OEM	
REC3853655	3853655	537-547
REC3853655		548
REC3853799	3853799	515
REC3853839	982187	513
REC3853839	985063	513
REC3853854	3853854	514
REC3853855	3853855	514
REC3853856	3853856	514
REC3853857	3853857	514
REC3853945	986280	513
REC3853945	3853945	513
REC3853983	3853983	515
REC3854001	986642	518
REC3854001	3854001	518
REC3854002	3854002	517
REC3854003	986650	518
REC3854003	3854003	518
REC3854020	986796	508
REC3854020	3854020	508
REC3854020	3854347	508
REC3854020		509
REC3854159	3854159	510
REC3854161	3854161	517
REC3854190	987811	512
REC3854190	3854190	512
REC3854217	3854217	518
REC3854260	3854260	518
REC3854261	3854261	519
REC3854311	20223	519
REC3854331	3854331	519
REC3854548	3854548	519
REC3854549	38071	519
REC3855081	311598	538-542-543-545
REC3855081	333572	540-541
REC3855275		541
REC3855276	981650	507
REC3855411	3855411	535
REC3857533	3857533	513
REC3858261	3854620	506
REC3858261	3857986	506
REC3858261	3858261	506
REC3858462	311046	548
REC3858462	3858462	548
REC3860769	985964	512
REC3860769	986008	512
REC3862500	3862500	531-532
REC3863090	3863090	541
REC3863191	351325	531
REC3863191	913784	534
REC3863191	3863191	532-533
REC3863193AL	3855411	535
REC3863450	3852741	530-531-532-533-549
REC387247	387247	539-543-549
REC387817	387817	543
REC3885317		512
REC392-9766	3853815	518
REC393-9459Q1	380541	518
REC397768	397768	535
REC397768AL	397768	535
REC398042	398042	543
REC398042	5008966	539-541
REC41400		510
REC423-6349	423-6349	519
REC431708	431708	535-539-543
REC431708AL	431708	535-539-543
REC436745	436745	535-538-543
REC436745AL	436745	535-538-543
REC439967	439967	539
REC439967	984458	539
REC46-8M0113733	3858340	534
REC46-8M0113734	985429	534
REC46-8M0113734	3853850	534
REC46335	908700	532
REC46335	3853404	531-532-533
REC479956		531-532-533
REC50-806965A4	988217	512
REC50-808011A05	981288	511

REF	OEM	
REC50-808011A05	984982	511
REC50-863007A1	3860566	512
REC50-97499A2	981289	511
REC50-97499A2	982202	511
REC50-99417A2	981078	511
REC50-99417A2	982121	511
REC50-99417A2	988217	511
REC50-99418A2	3860566	512
REC5006561	5006561	509
REC55125-90J01	5032542	535
REC55125-90J01	5032929	535
REC553126	31305	547
REC553126	25-31305	547
REC57-34359	912714	548
REC57-48122Q	3852504	548
REC57-78200Q1	3852504	548
REC62092T	982063	507
REC69729	988247	512
REC75832T	912214	537-549
REC764197	764197	537-538
REC764799	764799	532-534
REC777128	777128	537
REC777130	777130	542
REC802385	911702	537
REC806490T	3853787	510
REC823426A1	383918	507
REC823426A1	384743	507
REC823426A1	979659	507
REC823426A1	983864	507
REC823426A1		509
REC823427A1	982384	507-508-509
REC829207	310953	548
REC829207	909971	548
REC841994	983073	508
REC841994	984487	508
REC841994		509
REC853868	853858	540
REC853868	3853858	547
REC854040	3854402	541
REC86234A4	982240	507
REC86234A4	985602	507
REC86234A4	985603	507
REC878982	912477	534
REC879031	983218	516
REC8M0068784	3857532	510
REC8M0125617	3855184	510
REC907774	97774	542
REC907866	907866	542
REC908062	908062	542
REC908064	908064	542
REC908087	908087	542-546
REC908194	908194	545-547
REC909048	802149	547
REC909121	909121	542-549
REC909139	802149	547
REC909140	58390	547
REC909140	802151	547
REC909140	25-58390	547
REC909316	909316	537-547
REC909753	909753	542-546
REC91-805475A1	912273	549
REC910238	802383	547
REC911678	911678	537
REC911679	911679	537
REC911680	911680	537
REC911681	911681	537
REC911685	911685	537-547-548
REC911698	911698	537
REC911700	911700	537-547
REC911703	911703	537
REC911704	911704	537
REC911705	911705	538
REC911878	911878	538
REC915719	915719	538
REC915840	915840	537-544-546
REC925093	320303	547
REC925093	925093	540
REC947084	947084	546
REC951924	951924	540

REF	OEM	
REC966382	912509	548
REC967344	313446	539-547-549
REC967344	3852308	540
REC97258A1	171960	510
REC976669	976669	535
REC976669AL	976669	535
REC981196	981196	542
REC981268	981268	542
REC982438	982438	535
REC982438AL	982438	535
REC982997	982997	507
REC983494	983494	535-538-543
REC983494AL	983494	535-538-543
REC983878	983878	537
REC983952	983952	535
REC983952	984547	535
REC983952AL	983952	535
REC983952AL	984547	535
REC984491	802416	506
REC984744	984744	537-538

REF	OEM	
REC986158	3853930	535
REC986158AL	3853930	535
REC987067	3854061	535
REC987067AL	3854061	535
RECKITOMCCOBRAAL		535
RECKITOMCCOBRAAM		535
RECKITOMCCOBRAZN		535
RECKITOMCSTRINGERAL		535
RECKITOMCSTRINGERM		535
RECKITOMCSTRINGERZN		535
RECRA122002		511
RM3850470	983939	514
RM3850470	984731	514
RM3850470	3850470	514-544
RM3852516	910953	537
RM3856502	814603	540

POLÍTICA DE GARANTÍA RECMAR

Todos los productos comercializados por **RECMAR** deben ser instalados y utilizados por personal competente bajo su exclusiva responsabilidad. **RECMAR** no se responsabiliza de las consecuencias producidas por una instalación defectuosa o inapropiada de ningún artículo que no incluya soluciones de instalación.

El instalador será el responsable de verificar la correcta aplicación de las recomendaciones del fabricante en cuanto a compatibilidades de uso.

Los artículos comercializados por **RECMAR** están amparados por la garantía legal.

RECMAR distribuye los artículos presentes en sus catálogos únicamente a profesionales, nunca a particulares o cliente final, el importe de la instalación jamás estará incluido en el precio por lo que no será responsable de ésta.

Los artículos comercializados por **RECMAR** disponen de una garantía limitada por defectos de fabricación, los periodos pueden variar entre los 3 años y los 3 meses, descartando los artículos considerados como consumibles: productos eléctricos, baterías y otros que carecen de periodo alguno, si necesita conocer el plazo exacto del producto contacte con el departamento comercial.

El material que enviamos diariamente desde **RECMAR** a nuestros clientes es examinado antes de empaquetarse para su perfecta integridad y evitar daños en el transporte. Recuerde que es muy importante inspeccionar las cargas en presencia del transportista. Cuando se observen daños en la caja, deberá incluirse en el albarán de entrega del transportista una mención del tipo (CONFORME MERCANCÍA, SALVO INSPECCIÓN), y deberá ser firmada por usted y el transportista. En caso de recibir material defectuoso por estas causas debe hacerlo constar tanto al transportista como a **RECMAR** para poder reclamar a la empresa de transporte correspondiente.

SOLICITUD DE GARANTÍA

La garantía siempre estará sujeta a la valoración final del departamento técnico de **RECMAR**. Esta valoración se llevará a cabo en nuestras instalaciones o en caso necesario por el fabricante del artículo, en ambas opciones el artículo tiene que estar físicamente en nuestras instalaciones centrales de Viladecans. El tiempo para la resolución será un máximo de 30 días naturales desde su recepción.

Para enviar el artículo defectuoso, debe ir a la página web www.recambiosmarinos.es, o www.usarecmar.com ir a su cuenta y seleccionar TRAMITAR GARANTÍA dentro del área privada, desde aquí podrá descargar el archivo para la solicitud de garantías de motores y piezas, y seguir las instrucciones.

RECMAR no asumirá ningún préstamo de reemplazo durante el proceso de garantía.

EXCLUSIONES DE GARANTÍA

RECMAR no podrá ser acusado como responsable del defecto ante:

- Desgaste normal del producto.
- Defectos de instalación o uso inadecuado.
- Instalación de un artículo no destinado a ese modelo.
- Daños por causa externa (accidente, rayo, fluctuación de corriente...)
- Defectos y consecuencias relacionadas con el transporte.
- Alteraciones en instalaciones o barcos destinados a la competición.

En caso de rechazo de la garantía, el cliente tiene la posibilidad de recuperar su artículo defectuoso poniéndose en contacto con nosotros vía e-mail solicitando la devolución del mismo dentro de los 7 días naturales siguientes a la fecha en que se le informó del rechazo de garantía.

RECMAR no forma parte de las garantías comerciales anunciadas en ocasiones por los fabricantes.

RECMAR WARRANTY POLICY

All products sold by **RECMAR** must be installed and used by competent personnel under their exclusive responsibility. **RECMAR** shall not be responsible for the consequences of the faulty or improper installation of any item that does not include installation solutions.

The fitter will be responsible for checking that the manufacturer recommendations have been followed correctly in terms of compatible uses.

Articles sold by **RECMAR** are covered by legal warranty.

RECMAR distribute the products only to professionals and never to private final clients. The cost of installing the part would never be included in the price for which reason, **RECMAR** would never be responsible for its installation.

Articles sold by **RECMAR** are covered by warranty for manufacturing defects for a limited period of time that may vary between 3 years and 3 months, except for the articles considered consumable, electrical products, batteries and others that are not covered at all. For information on the exact warranty period of an article, please contact the Sales Department.

The goods that **RECMAR** sends every day to its customers are examined before being packed to ensure their perfect integrity and avoid damage during shipping. Remember that it is essential to check the goods in the presence of the dispatcher. If the package is damaged, the dispatcher's delivery note must mention what type (CONFORMING GOODS, UNLESS INSPECTED), and must be signed by you and by the dispatcher. If you receive damaged goods for these reasons you must notify both the dispatcher and **RECMAR** to be able to make the claim to the relevant delivery company.

WARRANTY CLAIMS

Warranties are always subject to **RECMAR** Technical Department's assessment. The assessment will be carried out on **RECMAR**'s premises or, if necessary, by the article's manufacturer. In both cases, the article must be physically on **RECMAR**'s premises in Viladecans. Assessment time will not exceed 30 calendar days from receiving the article.

To return the faulty item, visit www.recambiosmarinos.es, or www.usarecmar.com, go to your account and select PROCESS WARRANTY in the private section. From there you will be able to download the file to claim the warranty of engines and parts and follow the instructions.

RECMAR will not charge for the loan of the replacement during the warranty process.

WARRANTY EXCLUSIONS

RECMAR shall not be responsible for product faults in the following cases:

- Normal wear and tear of a product.
- Installation faults or improper use.
- Installation of an article not designed for the model in question.
- Damage due to external causes (accidents, lightning, power surges...)
- Defects and consequences of transport.
- Alterations to installations or to boats intended for competitions.

If the warranty is refused, the customer may retrieve the faulty article by contacting **RECMAR** via email and requesting that the article is returned to them within 7 calendar days from the day the warranty was refused.

RECMAR does not apply the warranties offered from time to time by manufacturers.

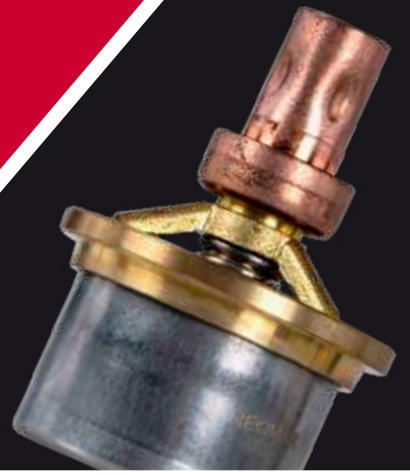

RECMAR
USA

1917 NW 79 Ave
Miami, FL 33126

Ph. 786-962-5020

info@usarecmar.com

www.usarecmar.com

RECMAR[®]

Jocelyn Bell, 26
08840 Viladecans
Barcelona

phone: (+34) 93 662 66 55

info@recambiosmarinos.es
www.recambiosmarinos.es

www.recmar.es