

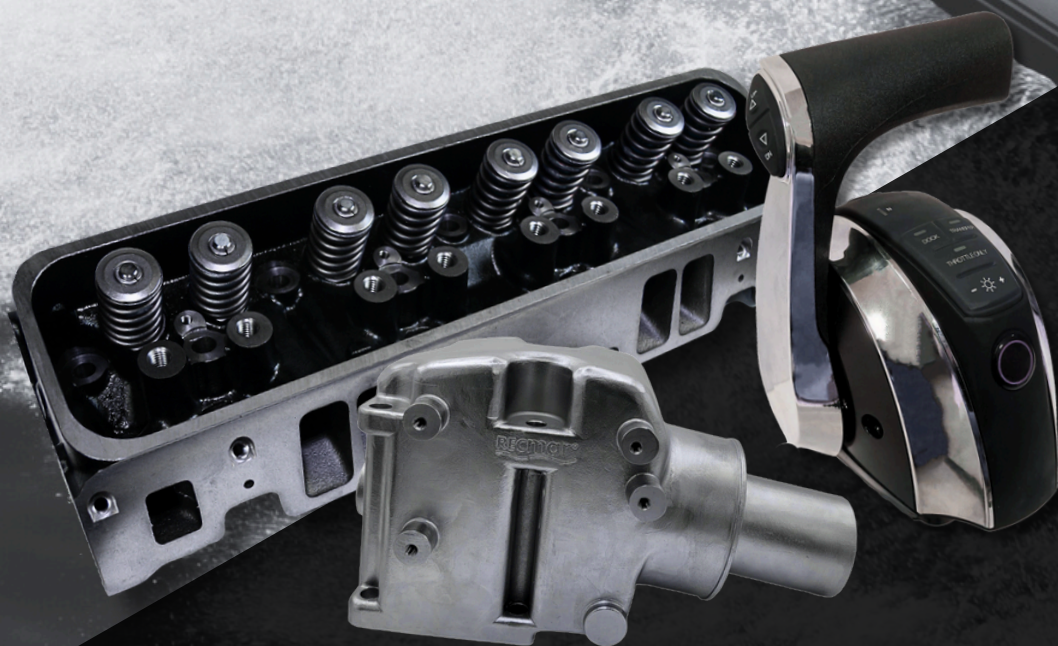















# RECMAR®





HIGH QUALITY MARINE PARTS











# FOR MERCRUISER



## ICONOS ICONS

	Medida	Measures
	Peso	Weight
	Material	Material
	Flujo Velocidad	Flow Speed
	Presión	Pressure
	Temperatura	Temperature
	Electricidad	Power
	Unidades x bolsa	Units x bag
	Unidades x skinpack	Units x skinpack
	Tornillo	Screw
	Tubo Manguera	Tube
	Rosca	Thread
	Rosca Macho	Male Thread
	Entrada	IN
	Salida	OUT

	Filtro	Filter
	Elemento filtro	Filter Element
	Junta	Gasket
	Llave	Key
	Posiciones llave	Key positions
	Mando	Control
	Pins	Pins
	Cables Terminales	Terminals
	Cable	Cable
	Piston	Piston
	Aros de piston	Piston ring
	Cojinete	Bearing
	Bulón	Pin
	Biela	Connecting rod
	Clip	Clip

	Impulsor	Impeller
	Dientes	Tooth
	Aguja carburador	Carburetor needle
	Flotador carburador	Carburetor float
	Abrazadera	Clamp
	Volante motor	Flywheel
	Estrias	Spline
	Polea	Pulley
	Solenide Relé	Solenoid Relay
	Motor	Motor

## IMPORTANTE

LOS PRODUCTOS QUE APARECEN EN NUESTROS CATALOGOS SON VÁLIDOS Y COMPATIBLES CON LOS MOTORES Y TRANSMISIONES DE LAS MARCAS ORIGINALES QUE APARECEN EN CADA SECCIÓN. ESTA INFORMACIÓN APARECE CON LA REFERENCIA EN EL MOMENTO DE CONFIRMAR EL PEDIDO POR NUESTRA WEB.

LA IMÁGENES AQUÍ CONTENIDAS PUEDEN NO CORRESPONDER CON TOTAL PRECISIÓN AL PRODUCTO SUMINISTRADO. RECAMBIOS MARINOS, S.L.U. SE RESERVA EL DERECHO DE ANULAR O CAMBIAR PRODUCTOS SIN PREVIO AVISO.

## IMPORTANT

THE PRODUCTS THAT APPEAR IN OUR CATALOGS ARE VALID AND COMPATIBLE WITH THE MOTORS AND TRANSMISSIONS OF THE ORIGINAL BRANDS THAT APPEAR IN EACH SECTION. THIS INFORMATION APPEARS WITH THE REFERENCE AT THE TIME OF CONFIRMING THE ORDER BY OUR WEB.

IMAGES CONTAINED HERE MAY NOT CORRESPOND WITH TOTAL ACCURACY TO THE PRODUCT SUPPLIED. RECAMBIOS MARINOS, S.L.U. RESERVES THE RIGHT TO CANCEL OR CHANGE PRODUCTS WITHOUT PRIOR NOTICE.

# EN

DRIVES MAINTENANCE KIT	151	RELAY FOR THROTTLE AND SHIFT	179	EXHAUST PROTECTOR VALVE	243
GUIDE: ENGINE MAINTENANCE	148	STARTER SOLENOID	179	MANIFOLD-ELBOW GASKET	241
GUIDE: IDENTIFICATION MODEL	146	TRIM SOLENOID	179	MANIFOLD-HEAD GASKET	243
GUIDE: MAINTENANCE TRASMISSIONS	152	<b>STARTERS</b>	175	SIDE GASKET CAP	242
<b>FUEL &amp; FILTRATION SYSTEM</b>	153	TRIM	178	WATER SHUTTER	242
<b>GAS ENGINE</b>	153	3 TO 2 WIRE WIRED CONVERTER	178	<b>MANIFOLDS</b>	239
FUEL FILTERS AND ELEMENTS	153	BRACKET	178	<b>STEERING SYSTEM</b>	188
CARBURETOR FUEL FILTER	153	<b>IGNITION SYSTEM</b>	181	<b>ENGINE CONTROLS</b>	188
IN-LINE FUEL FILTER	153	<b>DISTRIBUTOR</b>	183	<b>SWITCHES &amp; CABLES</b>	190
VST FILTER	154	CAP	183	<b>TRANSMISSION UNIT</b>	244
WATER SEPARATING FUEL FILTER	153	DISTRIBUTOR	185	<b>ANODES</b>	260
<b>OIL FILTER</b>	154	ELECTRONIC DISTRIBUTOR	185	<b>GEAR CASE PARTS</b>	244
FOR AXIUS POWER STEERING	154	• DELCO VOYAGER	186	MC1   R	246
<b>DIESEL</b>	155	• MPI V6 & V8	187	MR   ALPHA ONE	248
AIR FILTER	155	• THUNDERBOLT IV & V	187	ALHPA ONE GEN II	250
FUEL FILTERS AND ELEMENTS	155	ROTORS	184	BRAVO	256
COMPLETE DIESEL FILTER	155	TRIGGERS	184	BRAVO I	257
OIL FILTER	156	<b>IGNITION COIL</b>	181	BRAVO II	258
<b>CARBURETOR</b>	162	ELECTRONIC IGNITION	181	BRAVO III	259
CARBURATORS: GUIDE	164	<b>IGNITION MODULES</b>	182	<b>POWER TRIM</b>	272
GASKET KITS	165	HD SPARK PLUG WIRES SET	182	POWER TRIM HOSES	272
INLET NEEDLE KIT	166	<b>COOLING SYSTEM</b>	191	<b>SHIFT</b>	271
<b>FILTER ACCESSORIES</b>	157	<b>BELTS</b>	201	CABLE & KIT	271
<b>FUEL PUMP</b>	157	MICRO V BELTS GUIDE	203	SEAL KIT	271
COMPLETE FUEL MODULE	161	V-BELT GUIDE	201	SHIFT LEVER KIT	271
ELECTRIC FUEL PUMP & COOLER	161	V-BELT GUIDE WATER PUMP	201	<b>SILENBLOCK</b>	270
FUEL PRESSURE REGULATOR	162	<b>HEAT EXCHANGER</b>	195	<b>TOOLS</b>	275
GASKET	158	KITS	195	BEARING RETAINER WRENCH	275
HIGH PRESSURE FUEL PUMP	159	<b>HOSES</b>	205	BELLOW RINGS INTALLATION TOOL	276
LOW PRESSURE FUEL PUMP	160	HOSES FUEL GUIDE	206	BELLOWS EXPANDER TOOLS	276
MECHANICAL	157	HOSES FUEL GUIDE (STERN DRIVES)	206	ENGINE ALIGNMENT TOOL	275
MECHANICAL PUMP GUIDE	159	SEAWATER PUMP --> OIL COOLER	205	HINGE PIN TOOL	275
VST GASKETS	161	THERM. HOUSING --> EXHAUST MANIFOLD	205	PULLEY REMOVER, DRIVE PUMP	275
<b>INJECTOR</b>	162	WATER PUMP & SYSTEM	205	TOOLS FOR ELEMENTS TO DRIVESHAFT	275
<b>TURBO</b>	168	<b>IMPELLER GUIDE</b>	199	<b>TRANSOM PARTS</b>	263
EXHAUST CLAMP	168	<b>OIL COOLER</b>	194	<b>TRANSOM COMPONENTS</b>	269
GASKET KIT & SEALS	168	KITS	194	BELLOW	270
<b>RACOR</b>	157	RESERVOIR ASSY KIT	194	GASKET SET	269
<b>ELECTRIC SYSTEM</b>	169	<b>THERMOSTAT</b>	191	SHIFT CABLE	269
<b>ALTERNATORS &amp; VOLTAGE REGULATORS</b>	177	FITTING	191	<b>PROPULSION SYSTEM</b>	276
<b>SENSORS</b>	169	GASKETS	192	HUB KIT	276
AIR TEMPERATURE	172	SLEEVE	191	PROP LOCK KIT	276
AIR VALVE	170	THERMOSTAT HOUSING	191	<b>OEM --&gt; REF</b>	277
CAMSHAFT	170	THERMOSTAT KITS	192	<b>REF --&gt; OEM</b>	283
COOLANT TEMPERATURE	172	WATER DISTRIBUTION MODULE	191		
CRANKSHAFT	171	<b>WATER PUMPS</b>	195		
GUIDE	173	BRASS WATER PUMP	196		
IAC	170	<b>WATER PUMP SERVICE KIT</b>	198		
KNOCK	170	BELT TENSIONER V6 & V8	204		
MAT/MAP	169	WATER PUMPS PULLEY	204		
OIL PRESSURE	171	<b>ENGINE PARTS</b>	207		
OXYGEN	170	<b>MARINE GASKETS TO GM &amp; FORD ENGINES</b>	207		
PICK UP	169	<b>SEALS</b>	219		
TPS	169	CRANCKSHAFT SEAL	217		
TRIM	171	ENGINE GASKETS	216		
WATER TEMPERATURE	172	INTAKE VALVE	218		
<b>SOLENOID, RELAY</b>	179	O-RING GUIDE, OIL SEAL GUIDE	219		
ALARM	180	VALVE STEAM SEAL	218		
DELCO REMY SOLENOID	179	<b>TIMING GASKETS</b>	217		
IGNITION KILL SWITCH	180	<b>EXHAUST &amp; INTAKE SYSTEM</b>	222		
POWER TRIM SWITCH ASSY	180	<b>120 HP GM 153</b>	239		
RELAY FOR ALARM & OTHERS	179	MANIFOLD GASKET	239		
		<b>ELBOWS</b>	240		
		KIT RISER 3"	241		
		EXHAUST BELLOW	243		

# MERCUISER

ES

GUÍA IDENTIFICACIÓN DE MODELOS	146	RELÉ PARA ACELERADOR Y EJE	179	CODOS	240
GUÍA MANTENIMIENTO DE MOTORES	148	RELÉ PARA ALARMA Y VARIOS	179	KIT RISER 3"	241
GUÍA MANTENIMIENTO TRANSMISIONES	152	<b>TRIM</b>	178	TAPONES	242
KITS MANTENIMIENTO COLAS	151	CONVERTIDOR DE 3 A 2 CABLES	178	FUELLES ESCAPE	243
		SOPORTE	178	JUNTAS COLECTOR-CODO	241
<b>SISTEMA DE ALIMENTACIÓN Y FILTRACIÓN</b>	153	<b>SISTEMA ENCENDIDO</b>	181	JUNTAS COLECTOR-CULATA	243
<b>GASOLINA</b>	153	BOBINA ENCENDIDO	181	JUNTAS TAPAS LATERALES	242
FILTRO DE ACEITE	154	ENCENDIO ELECTRÓNICO	181	PALOMILLA Y TAPA ESCAPE	242
PARA DIRECCIÓN HIDRÁULICA AXIUS	154	<b>CABLES ALTO RENDIMIENTO</b>	182	<b>COLECTORES</b>	239
FILTRO DE COMBUSTIBLE Y ELEMENTOS	153	<b>DISTRIBUIDOR</b>	183	<b>SISTEMA DE GOBIERNO</b>	188
FILTRO EN LÍNEA	153	• DELCO VOYAGER	186	MANDOS DE CONTROL	188
FILTRO PARA CARBURADOR	153	• MPI V6 & V8	187	INTERRUPTORES Y CABLES	190
FILTRO SEPARADOR AGUA	153	• THUNDERBOLT IV & V	187	<b>UNIDADES DE TRANSMISIÓN</b>	244
FILTRO VST	154	DISTRIBUIDOR	185	<b>ANODOS</b>	260
<b>DIESEL</b>	155	DISTRIBUIDOR ELECTRÓNICO	185	<b>CAMBIO</b>	271
FILTRO DE ACEITE	156	ROTORES	184	CABLE	271
FILTRO DE AIRE	155	TAPA	183	KITS CAMBIO	271
FILTRO DE COMBUSTIBLE Y ELEMENTOS	155	TRIGGERS	184	KIT RETÉN	271
FILTRO DECANTADOR	155	<b>MÓDULOS IGNICIÓN</b>	182	<b>COMPONENTES TRANSMOM</b>	269
<b>ACCESORIOS PARA FILTROS</b>	157	<b>SISTEMA DE REFRIGERACIÓN</b>	191	CLIP FUELLE	270
<b>BOMBA DE COMBUSTIBLE</b>	157	<b>BOMBA DE AGUA</b>	195	FUELLE ESCAPE	270
BOMBA DE ALTA PRESIÓN	159	BOMBAS DE BRONCE	196	KIT FUELLES Y JUNTAS	269
BOMBA DE BAJA PRESIÓN	160	JUNTAS	197	<b>DESPIECE COLAS</b>	244
BOMBA MECÁNICA	157	<b>CORREAS</b>	201	MC1   R	246
BOMBA Y ENFRIADOR	161	GUÍA CORREAS BOMBA DE AGUA	201	MR   ALPHA ONE	248
GUÍA BOMBAS MECÁNICAS	159	GUÍA CORREAS MOTOR	205	ALPHA ONE GEN II	250
JUNTAS	158	GUÍA CORREAS SERPENTÍN	203	BRAVO	256
JUNTAS VST	161	<b>ENFRIADOR DE ACEITE Y KITS</b>	194	BRAVO I	257
MÓDULO DE COMBUSTIBLE COMPLETO	161	KITS BOTELLAS DE ACEITE	194	BRAVO II	258
REGULADORES PRESIÓN COMBUSTIBLE	162	<b>GUÍA DE IMPULSORES</b>	199	BRAVO III	259
<b>CARBURADOR</b>	162	<b>INTERCAMBIADOR DE CALOR Y KITS</b>	195	<b>HERRAMIENTAS</b>	275
GUÍA	164	<b>KIT DE REPARACIÓN</b>	198	CENTRADOR DE MOTOR	275
GUÍA KITS	166	<b>MANGUITOS MOTOR</b>	205	EXPANSOR DE FUELLES	276
JUNTAS Y KITS	165	BOMBA AGUA	205	EXTRACTOR POLEA BOMBA DE DIRECCIÓN	275
<b>INYECTORES</b>	162	BOMBA AGUA --> ENFRIADOR DE ACEITE	205	LLAVE PARA ELEMENTOS DEL CAMBIO	275
<b>RACORES</b>	157	CUERPO TERMOST. --> COLECTOR ESCAPE	205	LLAVE TORNILLO LATERAL TRANSMOM	275
<b>TURBO</b>	168	GUÍA MANGUITOS DE COLA	206	LLAVE TUERCA CARDAN	275
ABRAZADERA ESCAPE	168	GUÍA MANGUITOS EJE --> GASOLINA	206	ÚTIL INSTALACIÓN ANILLO DE FUELLE	276
KIT JUNTAS	168	TOMA AGUA	206	<b>POWER TRIM</b>	272
RETÉN ACEITE	168	<b>TERMOSTATO</b>	191	LATIGUILLOS POWER TRIM	272
<b>SISTEMA ELÉCTRICO</b>	169	CASQUILLO	191	<b>TRANSMOM - DESPIECES</b>	263
<b>ALTERNADORES Y REGULADORES</b>	177	CONECTOR RÁPIDO	191	<b>SISTEMA DE PROPULSIÓN</b>	276
<b>MOTORES DE ARRANQUE</b>	175	CUERPOS	191	KIT CIERRE DE HÉLICE	276
<b>SENSORES</b>	169	JUNTAS	192	NÚCLEO DE HÉLICE	276
ACEITE BOMBAS	172	KITS TERMOSTATOS	192	<b>OEM --&gt; REF</b>	277
ÁRBOL DE LEVAS	170	MÓDULO DISTRIBUCIÓN	191	<b>REF --&gt; OEM</b>	283
GUÍA SENSORES	173	<b>PARTES DEL MOTOR</b>	207		
IAC	170	<b>JUNTAS DISTRIBUCIÓN</b>	217		
MAT/MAP	169	JUNTAS TAPA	217		
OXÍGENO	170	<b>JUNTAS PARA BASES GM Y FORD</b>	207		
PICADO	170	<b>RETENES</b>	219		
PICK UP	169	GUÍA RETENS ACEITE	219		
POSICIÓN CIGÜENAL	171	GUÍA TÓRICAS	219		
PRESIÓN DE ACEITE	171	JUNTAS MOTOR 4CYL LINEA	216		
TPS	169	RETÉN ADMISIÓN ESCAPE	218		
TRIM	171	RETENES CIGÜENAL	217		
VÁLVULA DE AIRE	170	RETENES VÁLVULAS	218		
<b>SOLENOIDE - RELÉ</b>	179	VÁLVULA ADMISIÓN	218		
ALARMA	180	<b>SISTEMA DE ESCAPE Y ADMISIÓN</b>	222		
INTERRUPTORES DE PARO	180	<b>120 HP GM 153</b>	239		
INTERRUPTORES TRIM	180	JUNTA CODO ESCAPE	239		
SOLENOIDES ARRANQUE	179	JUNTA COLECTOR	239		
SOLENOIDES DELCO REMY	179	<b>DESPIECES COLECTORES Y CODO</b>	222		
SOLENOIDES TRIM	179				

MERCUISER

RECMAR®

145

# GUÍA IDENTIFICACIÓN DE MODELOS

# MODEL IDENTIFICATION CHART

	MOD.	S/N	
SEA RAY	3.0L	B787205-B917529	1988
	4.3L	B785483-B921276	1988
	4.3LX	B785981-B922330	1988
	5.7L	B784799-B917017	1988
	SRX5.7L, 350 MAG	B785241-B919012	1988
	SRX7.4L, 454 MAG ALPHA	B785149-B924857	1988
	SRX7.4L-H, 454 MAG BRAVO	B721206-B919343	1988
STERN DRIVES	SRX7.4L, ALPHA	B803866-C348032	1988
	SRX7.4L-H, BRAVO	B803872-B999972	1988
INBOARD ENGINES	5.7L	B788204-B919356	1988
	7.4L	B788179-B913769	1988
RENAULT 4 CYL. (STERN DRIVE)	60	1887079-5049044	1965-68
	80	2049045-2851423	1966-69
	90	2851424-3226957	1970-72
GM 4 CYL. (STERN DRIVE)	110	1537370-2044033	1963-66
	120	1666601-3377340	1964-72
	120	3377341-3770649	1972-73
	120	3770650-4952700	1974-77
	120	4952701-5192048	1978
	120	5192049-6229717	1979-82
	120	6229718-6853913	1983-84
	120	6853914-8531853	1985-86
	120/2.5L	B531854-C853255	1987-89
	140	2508261-6229717	1968-82
	140/3.0L	6229718-C856558	1982-89
	3.0L/LX	C856559+	1990
MERCURY MARINE 4 CYL. (STERN DRIVE)	470 (2 BBL)	4208730-5520114	1976-79
	470 (2 BBL)	5520115-6218036	1980-82
	470 (2 BBL)	6218037-6916778	1983-84
	170 (2 BBL)	6916779	1985-86
	165/3.7L (2 BBL)	6916779	1987-89
	485 (2 BBL)	5685394-6218036	1980-82
	488 (4 BBL)	6170297-6916778	1983-84
	190 (4 BBL)	6916779	1985-86
	180/3.7LX (4 BBL)	6916779	1987-89
GM INLINE 6 CYL. (STERN DRIVE)	140	1538930-1725960	1963
	150	1666495-2048046	1964-66
	160	2048022-2770031	1967-69
	165	2770032-5178958	1970-78
	165	5178959-5813433	1979-81
	200	2453769-2712072	1969
GM V6 (STERN DRIVE)	185 (4 BBL)	6330183-6919655	1983-84
	185 (2 BBL)	A331455-B527954	1985-87
	175/4.3L (2 BBL)	B527955-D714106	1987-92
	4.3L (GEN II) (2 BBL)	D714107-F000877	1992-93
	4.3L (GEN II) (2 BBL)	F000878-F601126	1993-95
	4.3L (GEN II) (2 BBL)	F601127-F000878	1996
	4.3LX (GEN+) (2 BBL)	F803000-K999999	1996-97
	4.3L (GEN+) (2 BBL)	L010044+	1998
	4.3L EFI (GEN+) (TBI)	L012009+	1998
	205 (4 BBL)	A331455-B527954	1985-87
	205/4.3LX (4 BBL)	B527955-D714369	1987-91
	4.3LX (GENII) (4 BBL)	D714370-F001219	1992-93
	4.3LX (GENII) (4 BBL)	F001220-F601126	1993-95
	4.3LX (GENII) (4 BBL)	F601127-F802999	1996
	4.3LXH (GEN+) (4 BBL)	F803114+	1996-97
4.3LH (GEN+) (4 BBL)	L010044+	1998	
	262 MAG (TBI) (GEN+)	F803800-K999999	1996-97
FORD V8 (STERN DRIVE)	888 (2 BBL)	3108723-4887829	1971-77
	215 (4 BBL)	2781153-3385720	1970-72
	225 (4 BBL)	3385721-4166999	1973-74
	225-S (4 BBL)	3385721-4166999	1973-74
	233	4173000-4902304	1975-77
	255	3258728-4175499	1971-74

	MOD.	S/N		
GM V8 283, 327, 305 & 350 CID	190	1564539-1730903	1963-64	
	898 (2 BBL)	4762210-6218461	1977-82	
	898 (2 BBL)	6218462-B525981	1983-84	
	200/5.0L (2 BBL)	6218462-F600999	1985-95	
	5.0L (2 BBL)	L015751+	1998	
	5.0L EFI	L012052-L340000	1998-99	
	228 (4 BBL)	4765100-5170008	1977-78	
	228 (4 BBL)	5170009-6218461	1979-82	
	228 (4 BBL)	6218462-B525981	1982-84	
	230 (4 BBL)	6218462-B525981	1985-86	
	230/5.0LX (4 BBL)	B525982-F600999	1987-95	
	225	1539620-2694014	1963-69	
	250	2314301-2639854	1968-69	
	255	417550-4767999	1975-76	
	250	4768000-4908849	1977	
	260/5.7L	4908850-6218461	1978-82	
	260/5.7L	621462-B525981	1982-86	
	260/5.7L	B525982-F600999	1987-95	
	5.7L (2 BBL)	F601000+	1996-98	
	5.7L EFI	F225560+	1995	
	5.7LX (4 BBL)	F601000-K999999	1996-97	
	5.7LX EFI	F752400-K999999	1996-97	
	5.7LX BRAVO EFI	F800300-K999999	1996-97	
	350 MAG ALPHA	A635178-B525981	1986-87	
	350 MAG ALPHA	B525982-F600999	1987-95	
	350 MAG ALPHA	F601000-K001526	1996	
	350 MAG ALPHA	K001527-K999999	1997	
	350 MAG ALPHA EFI	F800300-K999999	1996-97	
	350 MAG BRAVO MPI	F415189-K999999	1995-97	
	350 MAG BRAVO MPI (GEN+)	F602000-K999999	1996-97	
	350 MAG MPI (GEN+)	L010019+	1998	
	270	2851074-3385720	1969-72	
	280TRS	4176250-4770199	1975-76	
	300 TEMPEST	6668677-B430367	1985-86	
	320 EFI	A543604-C622418	1987-89	
		325	2278747-3780449	1969-72
		330	4623115-6083144	1977-81
		330	6083145-B816450	1982-87
		7.4L BRAVO	B771113-D603117	1988-91
		7.4L BRAVO (GEN V)	D603118-F800699	1992-96
		7.4L BRAVO (GEN VI)	F800700-K999999	1996-97
		7.4LX BRAVO (MPI) (GEN V)	F602010-F801999	1996
		7.4LX BRAVO (MPI) (GEN VI)	F802000-K999999	1996-97
		7.4L MPI (GEN VI)	L010003+	1998
		7.4LX BRAVO (TBI) (GEN VI)	F820000-K999999	1996-97
	454 MAG ALPHA	A631894+	1986-88	
	454 MAG BRAVO (GEN V)	D805069-F304999	1992-94	
	454 MAG BRAVO (GEN V)	F305000-F801699	1995-96	
	454 MAG BRAVO (GEN VI)	F801700-K999999	1996-97	
	454 EFI (GEN V)	F115700-F802349	1994-96	
	454 MAG MPI (GEN VI)	F802350-K999999	1996-97	
	454 MAG MPI (GEN VI)	L010029-L085399	1998	
	454 MAG MPI (GEN VI)	L085400+	1999	
	370 TRS	4179554-6721527	1978-85	
	370 TRS	6721528-B714586	1985-87	
	400 TRS	4179554-B457644	1980-86	
	420	A398941-D937011	1987-89	
	425	A398941-D937011	1990-93	
	440 TRS	4179554-B485220	1983-86	
	450 (GEN V)	F347100-F347277	1995-96	
	525 SC	D456000-F348963	1991-92	
	525 SC (GEN V)	D456000-F348963	1992-95	
	525 SC (GEN VI)	F615814-F745215	1996	
	525 SC (GEN VI)	F745260+	1996-97	
	390	2781129-3042731	1969-70	
	460 TRS	4719554-6181046	1983-86	
	465	C849992-F213244	1990-92	
	465 (GEN V)	C849992-F213244	1992-94	

	MOD.	S/N	
	500 (GEN V)	F213293-F745159	1994-96
	500 (GEN VI)	F745195-L001772	1997-98
	502 MAG BRAVO	C878221-D824588	1990-92
	502 MAG BRAVO (GEN V)	D824589-F114528	1992-93
	502 EFI (GEN V)	D840650-F802599	1993-96
	502 MAG MPI (GEN VI)	F802600-K999999	1996-97
GM V8 427, 454, 502, 540 Et 572 (STERN DRIVE)	500 EFI	L001477+	1999
	502 MAG MPI (GEN VI)	L085433+	1998
	600 SC	D456489-F877642	1991-92
	600 SC (GEN V)	D456489-F877642	1992-96
	600 SC (GEN VI)	K000227+	1997
	500 BULLDOG	C577254-F745405	1990-96
	500 BULLDOG	K000248+	1997
	575	A677429-D763716	1986-92
	800 SC (GEN V)	D763836+	1993-96
	ROVER 60HP	3140000F+	1965-67
	530 D-TA 150 HP	B993000-B993492	1989
	636 D-TA 180 HP	B993500-C696047	1989
MCM 4, 5, 6 Et V8 CYL. DIESEL (STERN DRIVE ENGINE)	D183 140 HP	B993493-D725149	1990-93
	D219 170 HP	C696048-D850124	1990-93
	D254 200 HP	C849484-D554729	1990-93
	D3.0L 140 HP	D725150+	1994
	D3.6L 170 HP	D850125+	1994
	D4.2L 200 HP	D554730+	1994
	D7.3L 238 HP	F060000+	1994
MERCURY MARINE MIE 4 CYL. (INBOARD)	470	5520115-6218036	1980-81
	198	4762210-6218461	1977
	228	4765100-5170008	1977-78
	228	5170009-5907057	1978-80
	230/5.0L (4 BBL)	5907058-B788151	1981-87
	225	2278647-2694014	1968
	250	2314301-2639854	1968-69
	255	4175500-5907057	1975-80
	260/5.7L	5907058-F024999	1981-93
	270	2851074-3077735	1969-72
	5.7L	F025000-K999999	1994-97
	5.7L (GEN+)	L002003+	1998
	5.7L MPI	K040300-K999999	1997
	350 MAG MPI (GEN+)	L002008-L304499	1998
	350 MAG MPI (GEN+)	L304500+	1999
	350 HORIZON	L304700+	1999
	5.7L SKI	A338533-B514626	1985-87
	5.7L COMPETITION SKI	B514627-F775199	1987-95
	5.7L COMPETITION SKI	F775200-K040003	1996
	5.7L COMPETITION SKI	K040004-K999999	1997
	5.7L COMPETITION SKI (GEN+)	L002005+	1998
	350 MAG SKI	D505454-K999999	1991-97
	350 MAG EFI SKI	F215561-K999999	1994-97
	350 MAG MPI SKI	F350583-F799999	1995-98
	BLACK SCORPION SKI	F800000+	1996-98
	325	2278747-3780449	1968-74
	330	4623115-5889913	1977-80
	340/7.4L W/B/W MK4	5889914	1981-92
	7.4L W/HURTH (LH) MK4	C391564-D715493	1989-92
	7.4L (LH)	D715494-K999999	1992-97
	7.4L MPI (LH)	F563050-K999999	1995-97
	7.4L MPI (L29) (GEN VI)	L002006+	1998
	7.4L TBI (LH) (GEN VI)	F874815-K999999	1996-97
	454 MAG MPI HORIZON	L002200-L086049	1998-99
	454 EFI (SKI) (GEN V)	F215800-F820099	1995-96
	454 MAG MPI (SKI) (GEN VI)	F820100-K999999	1996-97
	350	9780450-4623109	1974-76
	390	2781129-2825059	1969-70
	8.2L W/HURTH	C878221-D857199	1990-92
	8.2L (GEN V)	D857200-F819619	1993-96
	8.2L MPI (LH) (GEN VI)	F819620-K999999	1996-97
	8.2L MPI (LH) (GEN VI)	L002450-L0086012	1998
	8.2L MPI (LH) (GEN VI)	L0086013+	1999
GM MIE V8 427, 454, 482 Et 502 CID (INBOARD)			

	MOD.	S/N	
	215	2781153-3563181	1970-72
FORD MIE V8 (INBOARD)	225	3385721-4176999	1970-72
	233	4173000-4775784	1975-76
	255	3258728-4178299	1973-74
	530 D-TA 150 HP	B993002-C539258	1989
	636 D-TA 180 HP	B993750-C696011	1989
	D183 150 HP	C539259-D725149	1990-93
MIE 5, 6 Et V8 CYL. DIESEL INBOARD ENGINES	D219 180 HP	C696012-D850124	1990-93
	D254 210 HP	C849461-D554729	1990-93
	D3.0L 150 HP	D725150+	1994
	D3.6L 180 HP	D850125+	1994
	D4.2L 210 HP	D554730+	1994
	D7.3L 262 HP	F060000+	1994
MC 60, 80 Et 90 STERN DRIVES Et TRANSOM PLATES	60 (O)	1830753-2063740	1965-66
	80	2063741-2898029	1966-69
	90	2898020-3225967	1970-72
	I	1534570-1684187	1963
	II (1.33:1)	1474909-2278488	1962-67
MC I, II Et III	II (1.78:1)	2398798-2671321	1968-69
	III	2373127-3002613	1968-72
	III	5128065	1978
MC 1A, 1B Et 1C	1A, 1B Et 1C	1684188-1777798	1964
	1A, 1B Et 1C (E-Z SHIFT)	1776349-2065189	1965-66
	120/140	2062141-378049	1967-73
	120/140	3780850-4893634	1974-77
	120/140	4893635-6225576	1978-82
MC 120, 140, 160 Et 165	160	2065190-2763441	1967-69
	165	2763442-3780849	1970-73
	165	3780849-4890459	1974-77
	165	4890460-6268064	1978-82
	470	4208730-4893830	1976-77
MC 470 Et 485	470	4893835-6225576	1978-82
	485	5487437-6225576	1980-82
	888	3106717-3784374	1971-73
MC 488, 225S Et 233	888	3784375-4782329	1974-77
	225S	3856268-4200499	1974
	233	4200500-4782329	1975-77
	898/228	4782330-4898729	1977
MC 898, 228, 250 Et 260	898/228	4898730-6229157	1978-82
	250	4791300-4898729	1977
	260	4898730-6229157	1978-82
	R	6152230-6847029	1983-84
MC R, MR, ALPHA ONE, ALPHA ONE SS Et ALPHA ONE GEN II	MR	6810538-A479506	1985
	ALPHA ONE	A470165+	1986-90
	ALPHA ONE SS	A545004+	1986-89
	ALPHA ONE GEN II	D469859+	1991
	BRAVO ONE	B664190+	1988
MC BRAVO Et BLACKHAWK	BRAVO TWO	C564952+	1989
	BRAVO THREE	D763691+	1993
	BLACKHAWK	F186717+	1994
MC 215E Et 215 H	215 H	2782203-2909034	1970
	215 E	2782203-2909034	1970-72
	TR	3377316-3787239	1973
	TR	3787240-4794899	1974-76
	TR	4794900-5009866	1977
MC TR Et TRS	TR	5009867	1978
	TRS	3787240-4203749	1974-75
	TRS	4203750-4795399	1976
	TRS	4795400	1977



REF

UN.

3.0L GM181 I/L4 1987+ (0B450801+)	NGKBR6FS	(-0L096999)	BUJIA	SPARK PLUG	4
	NGKBPR6EFS	(0L097000+)	BUJIA	SPARK PLUG	4
	REC3852106	(-0L382121)	CORREA ALTERNADOR (dirección hidráulica)	ALTERNATOR BELT (hydraulic steering)	1
	RM57-862054Q	(0L382122+)	CORREA ALTERNADOR (sin dirección hidráulica)	ALTERNATOR BELT (without hydraulic steering)	1
	REC57-49043A1		CORREA DIRECCIÓN HIDRÁULICA	HYDRAULIC STEERING BELT	1
	REC57-65607Q		TERMOSTATO	THERMOSTAT	1
	REC59078Q3	(-0L340999)	TERMOSTATO (Enfriador cerrado)	THERMOSTAT (closed cooling)	1
	REC8M0091470	(0L341000+)	FILTRO ACEITE	OIL FILTER	1
	REC35-06003		ACEITE MOTOR	OIL	1
	REC25W40U3				4
3.0LX GM181 I/L4 (1990-1997)(0C856569 - 0K999999)	NGKBR6FS	(-0F603999)	BUJIA	SPARK PLUG	4
	NGKBPR6EFS	(0F604000+)	BUJIA	SPARK PLUG	4
	REC57-49043A1		CORREA ALTERNADOR (1 polea grove)	ALTERNATOR BELT (1 grove pulley)	1
	REC3852106		CORREA ALTERNADOR (3 poleas grove)	ALTERNATOR BELT (3 grove pulley)	1
	REC59078Q3		TERMOSTATO	THERMOSTAT	1
	REC8M0091470		TERMOSTATO (Enfriador cerrado)	THERMOSTAT (closed cooling)	1
	REC57-65607Q		FILTRO ACEITE	OIL FILTER	1
	REC35-06003		FILTRO ACEITE	OIL FILTER	1
	REC25W40U3		ACEITE MOTOR	OIL	1
	REC25W40U3				1
3.0 MPI EC (1A072812+)	NGKTR6IX		BUJIA	SPARK PLUG	4
	RM57-862054Q		CORREA ALTERNADOR	ALTERNATOR BELT	1
	REC8M0091470		TERMOSTATO	THERMOSTAT	1
	REC57-65607Q		CORREA DIRECCIÓN HIDRÁULICA (940 mm)	HYDRAULIC STEERING BELT (940 mm)	1
	REC35-06003		FILTRO ACEITE	OIL FILTER	1
	RM35-866594Q01		FILTRO GASOLINA	FUEL FILTER	1
	REC25W40U3		ACEITE MOTOR	OIL	1
	REC25W40U3				1
3.0L TKS Plus (1G404114)	NGKBPR6EFS		BUJIA	SPARK PLUG	4
	RM57-862054Q		CORREA ALTERNADOR	ALTERNATOR BELT	1
	REC8M0091470		TERMOSTATO	THERMOSTAT	1
	REC35-06003		FILTRO ACEITE	OIL FILTER	1
	REC25W40U3		ACEITE MOTOR	OIL	1
	REC25W40U3				1
	REC25W40U3				1
	REC25W40U3				1
4.3L (GEN II) (1992-96) (0D714107 - 0F802999)	NGKBR6FS		BUJIA	SPARK PLUG	6
	REC829207		CORREA ALTERNADOR (46")	ALTERNATOR BELT (46")	1
	REC57-816295Q		CORREA DIRECCIÓN HIDRÁULICA	HYDRAULIC STEERING BELT	1
	REC8M0089715		TERMOSTATO 140°	THERMOSTAT 140°	1
	REC8M0091470		TERMOSTATO 160°	THERMOSTAT 160°	1
	REC35-06004		FILTRO ACEITE	OIL FILTER	1
	REC35-06003		FILTRO ACEITE (filtro remoto)	OIL FILTER (remote filter)	1
	REC35-802893Q01		FILTRO GASOLINA	FUEL FILTER	1
	REC25W40U3		ACEITE MOTOR	OIL	2
	REC25W40U3				1
4.3L & LX (GEN +) (1996-98) (0F803000 - 0M614999)	NGKBR6FS		BUJIA	SPARK PLUG	6
	REC829207		TERMOSTATO 140°	THERMOSTAT 140°	1
	REC57-816295Q		TERMOSTATO 160°	THERMOSTAT 160°	1
	REC8M0089715		FILTRO ACEITE	OIL FILTER	1
	REC8M0091470		FILTRO ACEITE (filtro remoto)	OIL FILTER (remote filter)	1
	REC35-06004		FILTRO GASOLINA	FUEL FILTER	1
	REC35-06003		IMPULSOR	IMPELLER	1
	REC35-802893Q01	BRAVO	ACEITE MOTOR	OIL	1
	REC35-802893Q01		CORREAS	BELT	1
	REC35-802893Q01				1
4.3L CARB. ALPHA/ BRAVO (0M61500+)	NGKBPR6EFS		BUJIA	SPARK PLUG	6
	REC8M0089715		TERMOSTATO 140°	THERMOSTAT 140°	1
	REC8M0091470		TERMOSTATO 160°	THERMOSTAT 160°	1
	REC864493		TERMOSTATO 170° (enfriador cerrado)	THERMOSTAT 170° (closed cooling)	1
	REC35-06004		FILTRO ACEITE	OIL FILTER	1
	REC35-06003		FILTRO ACEITE (filtro remoto)	OIL FILTER (remote filter)	1
	REC35-802893Q01		FILTRO GASOLINA	FUEL FILTER	1
	REC47-59362Q01	BRAVO	IMPELLER STD (enfriador)	IMPELLER STD (cooling)	1
	REC47-862232A2	BRAVO	IMPELLER (enfriador cerrado)	IMPELLER (closed cooling)	1
	REC57-865615Q04	ALPHA	CORREA (dirección asistida)	BELT (power steering)	1
	REC57-865615Q03	BRAVO	CORREA (dirección asistida)	BELT (power steering)	1
	REC57-865615Q08	BRAVO	CORREA (dirección hidráulica compacta)	BELT (compact hydraulic steering)	1
	REC25W40U3		ACEITE MOTOR	OIL	2
4.3L EFI (GEN+) TBI (0L619000- 0L618999)	NGKBPR6EFS		BUJIA	SPARK PLUG	6
	REC8M0089715		TERMOSTATO 140°	THERMOSTAT 140°	1
	REC8M0091470		TERMOSTATO 160°	THERMOSTAT 160°	1
	REC35-06004		FILTRO ACEITE	OIL FILTER	1
	REC35-06003		FILTRO ACEITE (filtro remoto)	OIL FILTER (remote filter)	1
	REC35-802893Q01		FILTRO GASOLINA	FUEL FILTER	1
	REC47-59362Q01	BRAVO	IMPULSOR	IMPELLER	1
	REC25W40U3		ACEITE MOTOR	OIL	1
	REC25W40U3		CORREAS	BELT	1
	REC25W40U3				1





	REF			UN.
4.3L MPI ALPHA/BRAVO & EC MODELS (ALL SERIES) (OM300000+)	NGKTR6IX	BUJIA	SPARK PLUG	6
	REC8M0089715	TERMOSTATO 140°	THERMOSTAT 140°	1
	REC8M0091470	TERMOSTATO 160°	THERMOSTAT 160°	1
	REC864493	TERMOSTATO 170° (enfriador cerrado)	THERMOSTAT 170° (closed cooling)	1
	REC35-06004	FILTRO ACEITE	OIL FILTER	1
	REC35-06003	FILTRO ACEITE (filtro remoto)	OIL FILTER (remote filter)	1
	REC35-802893Q01	FILTRO GASOLINA	FUEL FILTER	1
	REC47-862232A2	BRAVO IMPULSOR	IMPELLER	1
	REC25W40U3	ACEITE MOTOR	OIL	2
		CORREAS	BELT	
4.5L MPI ALPHA/ BRAVO (2A441953+)	NGKBPR5EFS-13	BUJIA	SPARK PLUG	6
	REC864493	TERMOSTATO 170° (intercambiador de calor)	THERMOSTAT 170° (heat exchanger)	1
	REC8M0089715	TERMOSTATO 140°	THERMOSTAT 140°	1
	REC35-06003	FILTRO ACEITE	OIL FILTER	1
	RAC31871	FILTRO GASOLINA	FUEL FILTER	1
	REC47-862232A2	BRAVO IMPULSOR	IMPELLER	1
	REC25W40U3	ACEITE MOTOR	OIL	2
		CORREAS	BELT	
5.0L (1988-95) (OB774445 - 0F600999)	NGKBR6FS	BUJIA	SPARK PLUG	8
	REC8M0089715	TERMOSTATO 140°	THERMOSTAT 140°	1
	REC8M0091470	TERMOSTATO 160°	THERMOSTAT 160°	1
	REC35-06003	FILTRO ACEITE	OIL FILTER	1
	REC35-802893Q01	FILTRO GASOLINA	FUEL FILTER	1
	REC47-59362Q01	BRAVO IMPELLER (enfriador cerrado)	IMPELLER (closed cooling)	1
	REC57-13457Q	BRAVO CORREA BOMBA DE AGUA	WATER PUMP BELT	1
	REC57-34359	CORREA (dirección hidráulica)	BELT (hydraulic steering)	1
	REC3858462	CORREA ALTERNADOR (44")	ALTERNATOR BELT (44")	1
	REC829207	CORREA ALTERNADOR (46")	ALTERNATOR BELT (46")	1
	REC25W40U3	ACEITE MOTOR	OIL	2
		CORREAS	BELT	
5.0L & 5.0L EFI (1998-01) (OL015751 - 0M599999)	NGKBPR6EFS	BUJIA	SPARK PLUG	8
	REC8M0089715	TERMOSTATO 140°	THERMOSTAT 140°	1
	REC8M0091470	TERMOSTATO 160°	THERMOSTAT 160°	1
	REC99155T2	TERMOSTATO 170° (enfriador cerrado)	THERMOSTAT 170° (closed cooling)	1
	REC35-06003	FILTRO ACEITE	OIL FILTER	1
	REC35-802893Q01	FILTRO GASOLINA	FUEL FILTER	1
	REC47-59362Q01	BRAVO IMPELLER	IMPELLER	1
	REC25W40U3	ACEITE MOTOR	OIL	2
		CORREAS	BELT	
		CORREAS	BELT	
5.0L CARB. ALPHA/ BRAVO (OM600000+)	NGKBPR6EFS	BUJIA	SPARK PLUG	8
	REC8M0089715	TERMOSTATO 140°	THERMOSTAT 140°	1
	REC8M0091470	TERMOSTATO 160°	THERMOSTAT 160°	1
	REC35-06003	FILTRO ACEITE	OIL FILTER	1
	REC35-802893Q	FILTRO GASOLINA	FUEL FILTER	1
	REC47-59362Q01	BRAVO IMPULSOR	IMPELLER	1
	REC57-865615Q04	ALPHA CORREA (dirección asistida)	BELT (power steering)	1
	REC99155T2	ALPHA CORREA (sin dirección asistida)	BELT (without power steering)	1
	REC57-865615Q03	BRAVO CORREA (dirección asistida)	BELT (power steering)	1
	REC57-865615Q08	BRAVO CORREA (sin dirección asistida)	BELT (without power steering)	1
REC25W40U3	ACEITE MOTOR	OIL	2	
	CORREAS	BELT		
5.0L MPI ALPHA/ BRAVO & EC (OM300000+)	NGKTR4A15	BUJIA	SPARK PLUG	8
	REC8M0089715	TERMOSTATO 140°	THERMOSTAT 140°	1
	REC8M0091470	TERMOSTATO 160°	THERMOSTAT 160°	1
	REC99155T2	TERMOSTATO 160° (drenaje fácil)	THERMOSTAT 160° (easy drain)	1
	REC864493	TERMOSTATO 170° (drenaje fácil)	THERMOSTAT 170° (easy drain)	1
	REC35-06003	FILTRO ACEITE	OIL FILTER	1
	REC35-802893Q	FILTRO GASOLINA	FUEL FILTER	1
	REC35-866171A01	FILTRO GASOLINA (módulo gasolina)	FUEL FILTER (fuel module)	1
	REC35-892665	FILTRO GASOLINA (módulo gasolina)	FUEL FILTER (fuel module)	1
	REC47-862232A2	BRAVO IMPELLER	IMPELLER	1
	REC25W40U3	ACEITE MOTOR	OIL	2
		CORREAS	BELT	
		CORREAS	BELT	
5.7L CARB. ALPHA/ BRAVO & LX/ EFI (1998+) (OB525982 +)	NGKBPR6EFS (-OK999999)	BUJIA	SPARK PLUG	8
	NGKBPR6EFS (OL010037+)	BUJIA	SPARK PLUG	8
	REC8M0089715	TERMOSTATO 140°	THERMOSTAT 140°	1
	REC8M0091470	TERMOSTATO 160°	THERMOSTAT 160°	1
	REC99155T2	TERMOSTATO (enfriador cerrado)	THERMOSTAT (closed cooling)	1
	REC35-06003	FILTRO ACEITE	OIL FILTER	1
	REC35-802893Q	FILTRO GASOLINA	FUEL FILTER	1
	REC47-59362Q01	BRAVO IMPULSOR	IMPELLER	1
	REC25W40U3	ACEITE MOTOR	OIL	2
		CORREAS	BELT	



	REF			UN.	
350 MAG Et 350 MAG EFI (GEN+) (1986+) (0A635178 - 0K999999)	NGKBR6FS		BUJIA	SPARK PLUG 8	
	NGKBPR6EFS	EFI	BUJIA	SPARK PLUG 8	
	REC35-802893Q		FILTRO GASOLINA	FUEL FILTER 1	
	REC65L-13915-00	EFI	FILTRO GASOLINA VST	FUEL FILTER VST 1	
	REC35-06003		FILTRO ACEITE	OIL FILTER 1	
	REC8M0089715		TERMOSTATO 140°	THERMOSTAT 140° 1	
	REC8M0091470		TERMOSTATO 160°	THERMOSTAT 160° 1	
	REC47-59362Q01	BRAVO	IMPELLER	IMPELLER 1	
	REC25W40U3		ACEITE MOTOR	OIL 2	
			CORREAS	BELT	
350 MAG/MPI (0F415189+)	NGKBPR6EFS	(-0F601999)	BUJIA	SPARK PLUG 8	
	NGKTR6IX	(0F602000 - 0M299999)	BUJIA	SPARK PLUG 8	
	NGKTR4A15	(0M300000+)	BUJIA	SPARK PLUG 8	
	REC35-802893Q		FILTRO GASOLINA	FUEL FILTER 1	
	REC65L-13915-00	(-0M299999)	FILTRO GASOLINA VST	FUEL FILTER VST 1	
	REC864572	(0M300000 - 0W059999)	FILTRO GASOLINA IN-LINE	FUEL FILTRO IN-LINE 1	
	REC35-866171A01	(0W060000+)	FILTRO GASOLINA VST	FUEL FILTER VST 1	
	REC35-892665	(0W060000+)	FILTRO GASOLINA VST	FUEL FILTER VST 1	
	REC35-06003		FILTRO ACEITE	OIL FILTER 1	
	REC47-59362Q01	BRAVO (-0M299999)	IMPULSOR	IMPELLER 1	
	REC47-862232A2	(0M300000+)	IMPULSOR	IMPELLER 1	
	REC8M0089715		TERMOSTATO 140°	THERMOSTAT 140° 1	
	REC8M0091470		TERMOSTATO 160°	THERMOSTAT 160° 1	
	REC99155T2		TERMOSTATO 160° (drenaje fácil y enfriador cerrado)	THERMOSTAT 160° (easy drain & closing cooling) 1	
	REC25W40U3		ACEITE MOTOR	OIL 2	
			CORREAS	BELT	
	6.2L MPI Et 377 MAG MPI (0L302200+)	NGKTR6IX	(0L302200 - 0M299999)	BUJIA	SPARK PLUG 8
NGKTR4A15		(0M310000+)	BUJIA	SPARK PLUG 8	
NGKTR4A15		(0M300000+)	BUJIA	SPARK PLUG 8	
REC35-802893Q			FILTRO GASOLINA	FUEL FILTER 1	
REC864572		(0M311053+)	FILTRO GASOLINA IN-LINE	FUEL FILTRO IN-LINE 1	
REC35-866171A01		(0M398395+)	FILTRO GASOLINA VST	FUEL FILTER VST 1	
REC35-892665		(0M398395+)	FILTRO GASOLINA VST	FUEL FILTER VST 1	
REC35-06003			FILTRO ACEITE	OIL FILTER 1	
REC016940			FILTRO ACEITE TRANSMISIÓN	OIL FILTER TRANSMISSION 1	
REC47-59362Q01		(0L302200 - 0M299999)	IMPULSOR	IMPELLER 1	
REC47-862232A2		(0M310000+)	IMPULSOR	IMPELLER 1	
REC8M0089715			TERMOSTATO 140°	THERMOSTAT 140° 1	
REC8M0091470			TERMOSTATO 160°	THERMOSTAT 160° 1	
REC99155T2		(-0M316999)	TERMOSTATO (drenaje fácil y enfriador cerrado)	THERMOSTAT (easy drain & closing cooling) 1	
REC864493		(0M317000+)	TERMOSTATO (drenaje fácil y enfriador cerrado)	THERMOSTAT (easy drain & closing cooling) 1	
REC25W40U3			ACEITE MOTOR	OIL 2	
			CORREAS	BELT	
7.4L LX / 454 MAG MPI (1988+) (GEN V&VI) (0M771113 - 0M024330)	NGKBR6FS	(0K999999-)	BUJIA	SPARK PLUG 8	
	NGKBPR6EFS	(0L010003 - 0M024330)	BUJIA	SPARK PLUG 8	
	NGKBR6VX	MPI HORIZON	BUJIA	SPARK PLUG 8	
	REC35-802893Q		FILTRO GASOLINA	FUEL FILTER 1	
	REC65L-13915-00	(0F602010+)	FILTRO GASOLINA VST	FUEL FILTER VST 1	
	REC35-06003		FILTRO ACEITE	OIL FILTER 1	
	REC016940	HURT/ZEUS	FILTRO ACEITE TRANSMISIÓN	OIL FILTER TRANSMISSION 1	
	REC47-59362Q01		IMPELLER	IMPELLER 1	
	REC8M0089715		TERMOSTATO 140°	THERMOSTAT 140° 1	
	REC8M0091470		TERMOSTATO 160°	THERMOSTAT 160° 1	
	REC99155T2		TERMOSTATO (drenaje fácil y enfriador cerrado)	THERMOSTAT (easy drain & closing cooling) 1	
	REC25W40U3		ACEITE MOTOR	OIL 2	
			CORREAS	BELT	
	8.1L (0M0206000+)	NGKTR55IX	(-2006)	BUJIA	SPARK PLUG 8
NGKIZFR7M		(2007+)	BUJIA	SPARK PLUG 8	
REC35-802893Q			FILTRO GASOLINA	FUEL FILTER 1	
REC35-866171A01			FILTRO GASOLINA VST	FUEL FILTER VST 1	
REC35-892665			FILTRO GASOLINA VST	FUEL FILTER VST 1	
REC35-06003			FILTRO ACEITE	OIL FILTER 1	
REC016940		HURT/ZEUS	FILTRO ACEITE TRANSMISIÓN	OIL FILTER TRANSMISSION 1	
REC47-862232A2			IMPULSOR	IMPELLER 1	
REC25W40U3			ACEITE MOTOR	OIL 3	
			CORREAS	BELT	
8.2L (1A350802 - 2A041665)		NGKBPR6ES		BUJIA	SPARK PLUG 8
	REC35-802893Q		FILTRO GASOLINA	FUEL FILTER 1	
	REC35-866171A01		FILTRO GASOLINA VST	FUEL FILTER VST 1	
	REC35-892665		FILTRO GASOLINA VST	FUEL FILTER VST 1	
	REC35-06003		FILTRO ACEITE	OIL FILTER 1	
	REC016940	HURT/ZEUS	FILTRO ACEITE TRANSMISIÓN	OIL FILTER TRANSMISSION 1	
	REC47-862232A2		IMPULSOR	IMPELLER 1	
	REC25W40U3		ACEITE MOTOR	OIL 3	
			CORREAS	BELT	



	REF			
QSD 2.0 DIESEL	REC35-879172143	FILTRO AIRE	AIR FILTER	
	REC35-879172104	FILTRO COMBUSTIBLE	DIESEL FILTER	
	REC879150054	TERMOSTATO	THERMOSTAT	
	REC57-879172120	CORREA	BELT	
	TEN01320T	ANODO	ANODE	
	REC895207	FILTRO ACEITE (83mm)	OIL FILTER (83 mm)	
	REC35-879312041	FILTRO ACEITE (67mm)	OIL FILTER (67 mm)	
	JAB11979-0001	JABSCO IMPULSOR	IMPELLER	
	SHE10615K	SHERWOOD IMPULSOR	IMPELLER	
	QSD 2.8 DIESEL	REC879172	FILTRO AIRE	AIR FILTER
REC35-879172104		FILTRO COMBUSTIBLE	DIESEL FILTER	
REC8M0093561		TERMOSTATO	THERMOSTAT	
REC57-879194425		CORREA	BELT	
TEN01320T		ANODO	ANODE	
REC895207		FILTRO ACEITE	OIL FILTER	
JAB11979-0001		JABSCO IMPULSOR	IMPELLER	
SHE10615K		SHERWOOD IMPULSOR	IMPELLER	
QSD 4.2 DIESEL		REC35-898272048	FILTRO AIRE	AIR FILTER
		REC35-879172104	FILTRO COMBUSTIBLE	DIESEL FILTER
	REC879150054	TERMOSTATO	THERMOSTAT	
	REC57-898101579	CORREA	BELT	
	TEN01320T	ANODO	ANODE	
	REC895207	FILTRO ACEITE	OIL FILTER	
	JAB17937-0001-P	JABSCO IMPULSOR	IMPELLER	
	SHE15000K	SHERWOOD IMPULSOR	IMPELLER	
	3.0L V6 TDI DIESEL (TIER 3)	REC35-8M6002131	FILTRO AIRE	AIR FILTER
		REC35-8M0067337	FILTRO COMBUSTIBLE	DIESEL FILTER
RECGS01030		FILTRO COMBUSTIBLE	DIESEL FILTER	
REC8M0093480		TERMOSTATO	THERMOSTAT	
REC57-8M0093495		Alt+ P.Steering CORREA	BELT	
REC35-8M0066483		FILTRO ACEITE	OIL FILTER	
JAB17018-0001		IMPULSOR	IMPELLER	

MERCUISER

KITS MANTENIMIENTO COLAS

DRIVES MAINTENANCE KIT

	REF			
ALPHA ONE GEN I	RECKITALPHAI	REC60932A4	FUELLE TRANSON	
		REC54-815504320	ABRAZADERA INOX 32-50	
		REC47-89984Q5	KIT BOMBA AGUA	
		RECKITMALPHA1AL	KIT ÁNODOS	
		REC12-191833	JUNTA	
		REC26-455771	RETÉN	
		REC18654A1	FUELLE ESCAPE	
		REC27-94996Q2	KIT DE JUNTAS	
	ALPHA ONE GEN II	RECKITGENEII	REC816431A1	FUELLE TRANSON
			REC54-815504320	ABRAZADERA INOX 32-50
		REC12-191833	JUNTA	
		REC26-455771	RETÉN	
		RECKITMALPHA2AL	KIT ÁNODOS	
		REC47-43026Q06	KIT BOMBA AGUA	
		REC53-815949	CIERRE METALICO	
		REC18654A1	FUELLE ESCAPE	
		REC27-94996Q2	KIT DE JUNTAS	
BRAVO		RECKITBRAVO	REC86840A05	FUELLE TRANSON
		REC54-815504320	ABRAZADERA INOX 32-50	
		REC12-191833	JUNTA	
		REC16755Q1	KIT DE JUNTAS	
		RECKITM BRAVO3AL	KIT ÁNODOS	
		CM806188A	ÁNODO AL	
		REC18654A1	FUELLE ESCAPE	



RECMAR



	REF				
TR/TRS (1977-93) (4794900+)	REC27-54014Q1	KIT JUNTAS TRANSOM	TRANSOM GASKET KIT	1	
	REC60932A4	FUELLE TRANSMISION	TRANSMISSION BELLOW	1	
	REC10-79953Q04	TAPON DE NIVEL ACEITE	OIL LEVEL CAP	1	
	REC10-79953Q04	TAPON DRENAJE ACEITE	OIL DRAIN CAP	1	
	REC31640Q4AL	ANODO TIMON	RUDDER ANODE	1	
	REC80W90U6	ACEITE SINTETICO 80W-90	SYNTHETIC OIL 80W-90	2	
R/ MR/ ALPHA ONE (1983-90) (6216687 - 0F386995)	REC27-94996Q2	KIT JUNTAS TRANSOM	TRANSOM GASKET KIT	1	
	REC30-879194A01	RODAMIENTO TRANSOM	TRANSOM BEARING	1	
	REC60932A4	FUELLE TRANSMISION	TRANSMISSION BELLOW	1	
	REC18654A1	FUELLE ESCAPE	EXHAUST BELLOW	1	
	REC78458A1	FUELLE ESCAPE TUBO (454 MAG)	EXHAUST BELLOW TUBE (454 MAG)	1	
	REC74639Q02	FUELLE CABLE CAMBIO	SHIFT WIRE BELLOW	1	
	REC10-79953Q04	TAPON DE NIVEL ACEITE	OIL LEVEL CAP	1	
	REC22-67892A05	TAPON DERENAJE ACEITE	OIL DRAIN CAP	1	
	REC31640Q4AL	ANODO TIMON (2-3/8")	RUDDER ANODE (2-3/8")	1	
	REC55989Q9AL	ANODO TIMON (4")	RUDDER ANODE (4")	1	
	REC55989Q9	ANODO BOLA TRANSOM	BALL ANODE TRANSOM	1	
	REC821631Q1AL	ANODO TRANSOM (MERCAT)	TRANSOM ANODE (MERCAT)	1	
	CM43994	ANODO TRANSOM (MERCAT) ANTIGUO	TRANSOM ANODE (MERCAT) OLD	1	
	RECKITMALPHA1AL	KIT ANODOS	ANODE KIT	1	
	REC32-32461	TUBO AGUA 5/8" TRANSOM	WATER TUBE 5/8" TRANSOM	1	
	REC32-4172533	TUBO AGUA 3/4" TRANSOM	WATER TUBE 3/4" TRANSOM	1	
	REC47-89984T4	IMPULSOR	IMPELLER	1	
	REC47-89984Q5	KIT BOMBA DE AGUA	WATER PUMP KIT	1	
	REC865436A03	KIT CABLE CAMBIO	SHIFT WIRE KIT	1	
	REC805320A03	KIT SENSORES TRIM	SENSOR TRIM KIT	1	
	REC80W90U6	ACEITE SINTETICO 80W-90	SYNTHETIC OIL 80W-90	2	
	APLHA ONE (GENII) (1991+) (0D469259+)	REC27-94996Q2	KIT JUNTAS TRANSOM	TRANSOM GASKET KIT	1
		REC30-879194A01	RODAMIENTO TRANSOM	TRANSOM BEARING	1
		REC816431A1	FUELLE TRANSMISION	TRANSMISSION BELLOW	1
		REC18654A1	FUELLE ESCAPE	EXHAUST BELLOW	1
		REC74639Q02	FUELLE CABLE CAMBIO	SHIFT WIRE BELLOW	1
REC10-79953Q04		TAPON DE NIVEL ACEITE	OIL LEVEL CAP	1	
REC22-67892A05		TAPON DERENAJE ACEITE	OIL DRAIN CAP	1	
CM821629		ANODO PLACA	PLATE ANODE	1	
REC821631Q1AL		ANODO TRANSOM (MERCAT)	TRANSOM ANODE (MERCAT)	1	
REC76214Q5AL		ANODO TIMON (plano)	RUDDER ANODE (flat)	1	
CM46399		ANODO TIMON (aleta)	RUDDER ANODE (flap)	1	
REC806105Q1AL		ANODO HELICE (CARRIER)	PROPELLER ANODE (CARRIER)	1	
REC806189Q1AL		ANODO BRAZO TRIM	TRIM ARM ANODE	2	
RECKITMALPHA2AL		KIT ANODOS	ANODE KIT	1	
REC32-4172533		TUBO AGUA TRANSOM	WATER TUBE TRANSOM	1	
REC47-43026Q02		IMPULSOR	IMPELLER	1	
REC817275Q05		KIT BOMBA DE AGUA	WATER PUMP KIT	1	
REC865436A03		KIT CABLE CAMBIO	SHIFT WIRE KIT	1	
REC805320A03		KIT SENSORES TRIM	SENSOR TRIM KIT	1	
REC80W90U6		ACEITE SINTETICO 80W-90	SYNTHETIC OIL 80W-90	2	
BRAVO I / II & III		REC16755Q1	KIT JUNTAS TRANSOM	TRANSOM GASKET KIT	1
		REC30-879194A01	RODAMIENTO TRANSOM	TRANSOM BEARING	1
		REC86840A05	FUELLE TRANSMISION	TRANSMISSION BELLOW	1
		REC18654A1	FUELLE ESCAPE	EXHAUST BELLOW	1
		REC78458A1	FUELLE ESCAPE COLECTOR	EXHAUST BELLOW	1
		REC74639Q02	FUELLE CABLE CAMBIO	SHIFT WIRE BELLOW	1
	REC22-67892A05	TAPON DE NIVEL ACEITE	OIL LEVEL CAP	1	
	REC22-67892A05	TAPON DERENAJE ACEITE	OIL DRAIN CAP	1	
	CM821630	ANODO PLACA	PLATE ANODE	1	
	CM43994	ANODO TRANSOM (MERCAT)	TRANSOM ANODE (MERCAT)	1	
	CM76214Q5	ANODO TIMON (Plano con rosca)	RUDDER ANODE (flat with thread)	1	
	CM762144	ANODO TIMON (plano sin rosca)	RUDDER ANODE (flat without thread)	1	
	CM806188	ANODO HELICE (CARRIER)	PROPELLER ANODE (CARRIER)	1	
	CM865182CZ	ANODO EJE HELICE (BRAVO III 2004+)	SHAFT PROPELLER ANODE (BRAVO III 2004+)	1	
	CM806190	ANODO BRAZO TRIM	TRIM ARM ANODE	2	
	REC55989Q9	ANODO BOLA TRANSOM	BALL ANODE TRANSOM	1	
	RECKITBRAVO	KIT ANODOS BRAVO I	ANODE KIT BRAVO I	1	
	RECKITMBRAVO23AL	KIT ANODOS BRAVO II	ANODE KIT BRAVO II	1	
	RECKITMBRAVO3AL	KIT ANODOS BRAVO III	ANODE KIT BRAVO III	1	
	REC32-43437	TUBO AGUA TRANSOM (BRAVO I)	WATER TUBE TRANSOM (BRAVO I)	1	
	REC815471T1	KIT CABLE CAMBIO	SHIFT WIRE KIT	1	
	REC805320A03	KIT SENSORES TRIM	SENSOR TRIM KIT	1	
	REC80W90U6	ACEITE SINTETICO 80W-90	SYNTHETIC OIL 80W-90	3	

# SISTEMA DE ALIMENTACIÓN Y FILTRACIÓN FUEL & FILTRATION SYSTEM

MORE FILTERS  
13

## FILTRO DE COMBUSTIBLE Y ELEMENTOS

## FUEL FILTERS AND ELEMENTS



### MOTORES GASOLINA

### GAS ENGINE

#### FILTRO COMBUSTIBLE SEPARADOR DE AGUA

#### WATER SEPARATING FUEL FILTER

REF	R.O./OEM		
RM35-866594Q01	35-866594Q01 35-866594K01	100VAZER, 100VAZER EC	3.0L MPI EC



#### FILTRO COMBUSTIBLE PARA MONTAJE EN LÍNEA

#### IN-LINE FUEL FILTER

REF	OEM		
REC864572	864572 35-864572	3/8"	EFI & MPI, 8.1L & 496 CID (in-line) MPI & EFI (boost pump)



REF	OEM		
REC35-8M0046752	35-8M0046752 35-11004A1 35-803897Q1	4 7/16"	2.5L/3.0L (6229718+) MCM224 CID (6218037+) GM262 CID (A331455+) con carter de bomba combustible with carter fuel pump



REF	OEM		
REC35-866171A01	35-866171A01	4 7/16"	5.0 - 350 - 6.2 & 8.1 MPI, MIE 496 MAG con módulo de bomba combustible with fuel pump module



REF	OEM	
REC35-8M0122423	35-884380T 35-8M0020349 35-8M0060041	MCM 4.5L (V6) 6.2L (V8)



#### FILTRO DE GASOLINA CARBURADOR

#### CARBURETOR FUEL FILTER

REF	OEM	CARB.
REC35-49088A2	35-49088Q2 35-49088A2	4 Et6 CYL INLINE



REF	OEM	CARB.
REC984491	802416	Rochester



MERCUISER

RECMAR



### FILTRO VST

### VST FILTER

REF	OEM	
REC65L-13915-00	808504	262 MAG (TBI) GEN+
	8085041	350 MPI, TBI, EFI (1994-96)
	808504T1	454 EFI (GEN V) GM (1994-96)
		454 EFI (SKI GEN V) GM (1995)
		454 MAG BRAVO MPI (GEN VI) GM (1996-97)
		5.7 EFI (TBI) GM 350 V8 (1995)
		7.4L MIE MPI (LH) (GEN V) GM (1995-96)
		7.4L MIE MPI (LH) (GEN VI) GM (1996-97)
		7.4LX BRAVO MPI (GEN V) GM (1996)
	7.4LX BRAVO MPI (GEN VI) GM (1996-97)	
	8.2L MIE MPI (LH) (GEN VI) GM (1996-97)	



REF	OEM	
REC35-892665	35-892665	5.0 (350, 377, 383, 496) 6.2 Et 8.1 MPI





### FILTRO DE ACEITE

### OIL FILTER



REF	OEM	
REC3850559	35-16595Q	2006+ MCM HiPerformance GM V8



REF	OEM		
REC35-06004	35-883702Q	18 mm x 1.5	GM V6
REC35-06003	35-866340Q03	13/16" x 16 NPT	GM 4 inline, V8
REC35-06007	35-802886Q	3/4" x 16 NPT	V8 Ford
	60565		
	35-8M0116378		



### FILTRO ACEITE PARA DIRECCIÓN HIDRÁULICA AXIUS

### HYDRAULIC OIL FILTER FOR AXIUS POWER STEERING



REF	OEM	
REC35-8M0138697	35-8M0138697 35-881132T	MCM AXIUS STEERING



FILTRO DE COMBUSTIBLE Y ELEMENTOS

FUEL FILTERS AND ELEMENTS



MOTORES DIESEL

DIESEL ENGINE

REF	OEM	
REC882376	882376	1.7DTI Original MS120

REF	OEM	
REC35-807256	35-807256T	D3.0L D3.6L D7.3L D-Tronic CMD 2.8 CMD 4.2 D2.8L

REF	OEM	
REC35-8M0067337	35-8M0067337	MCM/MIE 1.9L, 2.5L, 3.0L V6 AMD V8 TDI

REF	OEM	MICRON	
REC35-8M6002390	35-8M6002390	2	MCM/MIE 4.2L V8 TDI 335 Et 370 (CMC000200+)



FILTRO DECANTADOR DIESEL

COMPLETE DIESEL FILTER

REF	OEM		
REC500MA	35-850481 35-850481A1	RAC913-08-H6 (13 mm) RAC913-08-H8 (10 mm)	227 l/h







FILTROS AIRE



AIR FILTER

REF	OEM	
REC35-8M6002131	35-8M6002131	3.0L TDI 100/230/260 V6

REF	OEM	
REC35-879172143	35-879172143	CMD OSD 2.0 115/130/150/170

REF	OEM		
REC35-898272048	35-898272048	CMD QSD 4.2 270/320/350	

REF	OEM		
REC879172	879172 896332162	CUMMINS CMD 2.8 ES, EFI	



REF	OEM		
REC35-19487	35-19487	530D 636D D183 D219 D254 D7.3L	

REF	OEM		
REC35-805312	35-805312	D2.8L D254 D4.2L CMD MODELES	

FILTRO DE ACEITE

OIL FILTER







REF	OEM			
REC3517857	35-803470 35-80470Q	3/4" x 16 NPT	60 & 80 HP (RENAULT)	

Filtro corto  
Short filter



REF	OEM			
REC3850559	35-16595T1 35-16595Q 35-52731	13/16" x 16 NPT	230 CID, 250 CID 198 GM, 228 GM, 150 GM 330, 350, 370, 400, 420, 440, 460, 898	



Filtro largo  
Long filter

REF	OEM			
REC35-879312041	35-879312041	(2008+) QSD 2.0 MCM ES 30 (88206399+) MCM ES 150 (88221799+) MCM ES 170 (88231000+) MIE EI 115 (88200499+) MIE EI 130 (88205099+) MIE EI 150 (88220299+) ME EI 170 (88230000+)	67 mm	

REF	OEM		
REC35-8M0066483	35-8M0066483	3.0L V6 4.2L V8 TDI	

REF	OEM		
REC127695-35150	35-19485	530D, 636D D2.8L, D3.0L, D3.6L, D4.2L Motores VM engines	

REF	OEM		
REC882687	882687 35-8M0150917	1.7DTS 120 diesel	

REF	OEM		
REC895207	895207	3.25" (83 mm) CUMMINS 2,8L CMD, QSD 2.0 / 2.8 / 4.2	

## RACORS



REF		
GS30430	8 mm	2
GS30431	10 mm	2



  

REF		
REC500MACON	500	3/8" = 10 mm



## RACORS

REF		
GS30432	8 mm	2
GS30433	10 mm	2



## ACCESORIOS PARA FILTROS

### SENSOR DE AGUA PARA FILTROS DIESEL



REF
RECRK21069





## FILTER ACCESSORIES

### WATER SENSOR FOR DIESEL FILTERS

## BOMBA DE COMBUSTIBLE

### BOMBA DE COMBUSTIBLE MECÁNICA

REF	OEM			
REC862077A1	41141A2 862077A1	V6 231, 262, 229	REC35-8M0046752	REC27-34213

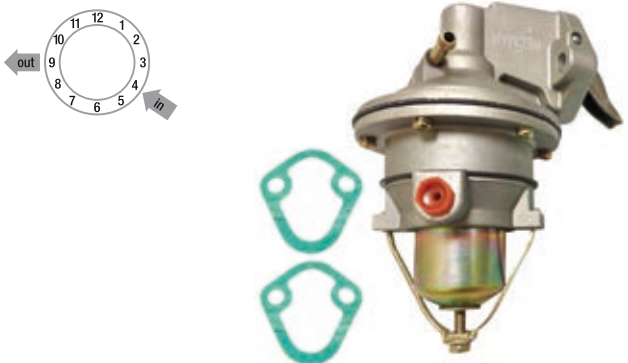



## FUEL PUMP

### FUEL PUMP MECHANICAL

REF	OEM	
REC862048A1	812454A1 812454A3 97399A2 862048A1 97399	V8 305, 350, 454, 330, 420 Inline (4 cyl) 120, 140, 3.0L & 224 CID



REF	OEM	
REC62092T	62092T 62092 54552	Ford V8 302



REF	OEM	
REC861677T	861677T 818383T	GM V8 (454 & 502)



REF	OEM	
REC86247T	86247T	V8 454 330, 325, 350, 390
	86247	
	86247A2	
	78820	
	63196	
	46860	

REF	OEM		
REC8M0073435	8M0073435	GM 4 cyl (2.5 / 3.0L) MCM 3.7L 3.0L (SNL097000+)	REC35-8M0046752
	861676T09		
	861676A1		
	842725A3		

REF	OEM	
REC86246T	86246T	V8 305, 350, 400, 228, 250, 255, 260, 280
	86246	
	86246A1	
	78485	
	71646	

REF	OEM		
REC86234A4	86234A4	GM (4 & 6 cyl) 153, 181, 225, 250, 120, 140, 160, 165, 470, 185, 488	REC35-49088A2
	8623405		
	86234A3		
	86234		
	77594		
	71327		
	47585		

REF	OEM	
REC8M0058164	8M0058164	GM V8 305, 350, 228 / 230 / 260 / 898
	97401	

JUNTAS GASKETS

REF	OEM
REC27-34213	27-34213
REC27-42457	27-42457
REC27-72805	27-72805
REC27-34898	27-34898

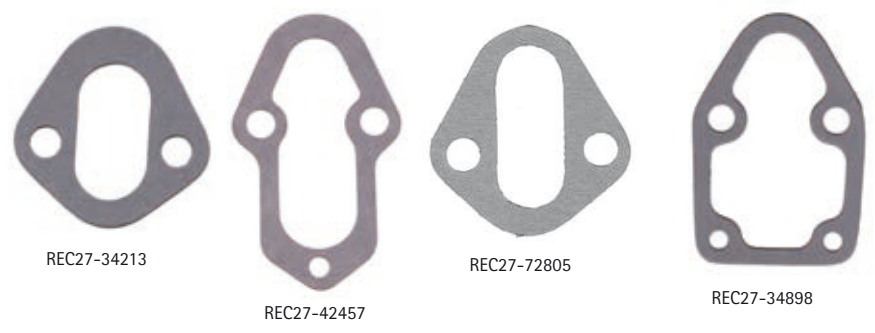

**GUÍA BOMBAS MECÁNICAS**

**MECHANICAL PUMP GUIDE**

MOD.	SERIAL	REF
120	1666601 - 3377340	REC86234A4
120	-4469866	REC86234A4
120	4469866 - 4952700	REC86234A4
120	4952701	REC86234A4
120	5192049 - 6229717	REC86234A4
120/2.5L	6229718	REC86234A4
120/2.5L	6229718	REC8M0073435
140 (4 CYL.)	2508261 - 3332137	REC86234A4
140	-4460664	REC86234A4
140	4460665-4918569	REC86234A4
140	4918570	REC86234A4
140 (4 CYL.)	5157669 - 6229717	REC86234A4
140/3.0L	6229718	REC86234A4
140/3.0L	6229718	REC8M0073435
3.0L/3.0LX	C856559+	REC8M0073435
160	2048022 - 2770031	REC86234A4
165	4471566 - 4884834	REC86234A4
165	5178959	REC86234A4
165/3.7-LX (4 CIL.)	6916779	REC8M0073435
170 (4 CIL.)	6916779	REC8M0073435
180/3.7-LX (4 CIL.)	6916779	REC8M0073435
175/4.3L (262 CID)	B527955+	REC862077A1
185 (229 CID)	6330183	REC862077A1
185 (262 CID)	A331455+	REC862077A1
190 (4 CIL.)	6916779	REC8M0073435
200	2453769 - 2712072	REC86234A4
200 GM	6218462	REC8M0058164
200/5.0L GM	B525982+	REC8M0058164
205 (262 CID)	A331455+	REC862077A1
205/4.3L-LX (262 CID)	B527955+	REC862077A1
215 FORD	-3085036	REC62092T
215 FORD	3258182	REC62092T
225 FORD	3385721	REC62092T
228 GM	4765100 - 5170008	REC86246T
228 GM	5170009 - 6218461	REC86246T
228 GM	6218462	REC8M0058164
230 GM INBOARD	5907058	REC8M0058164
230/5.6L-GM (IB)	B522506+	REC8M0058164
230 GM	6218462	REC8M0058164
230/5.0L-LX GM	B525982+	REC8M0058164
233 FORD	4500860	REC62092T

MOD.	SERIAL	REF
255 GM	4768000 - 4908849	REC86246T
255 GM	3258728	REC62092T
260 GM	4175500 - 5195908	REC86246T
260 GM	5195909	REC86246T
260/5.7 GM	4908850 - 6218461	REC86246T
260 GM INTRABORDA	6218461	REC8M0058164
260/5.7L GM (IB)	B525982+	REC8M0058164
5.7L-GM	5907058	REC8M0058164
280 GM	5907058	REC8M0058164
300MR/TRS GM	F025000+	REC8M0058164
325-GM	4176250	REC86246T
330 GM	6668677	REC8M0058164
330 GM/W.B.W.	2278747 - 3640670	REC86247T
340/7.4L-GM (IB)	4623115	REC86247T
350 GM	6083145	REC862048A1
350-GM (MAGNUM)	5889914	REC862048A1
350 (MAG-TOURNEY SKI)	3780450	REC86247T
370 TRS-GM	A635178+	REC8M0058164
390-GM	D505450+	REC8M0058164
420-GM	6721528	REC862048A1
425-GM	2781129 - 2825059	REC86247T
454 GM (MAGNUM)	A398941+	REC862048A1
454 MAG. BRAVO GM	A398941+	REC862048A1
470	A631894 +	REC862048A1
470	B840126+	REC862048A1
470	-5097479	REC86234A4
470	5097480	REC86234A4
485	5520115 - 6218036	REC86234A4
488	6218037	REC86234A4
888 FORD	5685394	REC86234A4
898/198-GM	6170297	REC86234A4
898 GM	3108723	REC62092T
5.7 GM (SKI)	4762210 - 6218461	REC86246T
5.7 GM (SKI)	6218462	REC8M0058164
5.7L BRAVO (GM)350	A338553+	REC8M0058164
7.4L BRAVO GM	B514627+	REC8M0058164
7.4L W/HURTH (IB)	B525982+	REC8M0058164
7.4 BRAVO (GEN V)	B771113+	REC862048A1
7.4 BRAVO (GEN VI)	C391564+	REC862048A1
454 MAG BRAVO MPI (GEN VI) 1996-97		REC861677T

**BOMBA DE COMBUSTIBLE ALTA PRESIÓN**

**HIGH PRESSURE FUEL PUMP**

REF	OEM	
REC861156A1	861156A1	350 Mag M.P.I. Alpha/Bravo/Horizon/MIE/Ski 4.3L EFI/Gen+ TBI/M.P.I. Alpha/Bravo-454 Mag M.P.I. Bravo Et Horizon 5.0/5.7L EFI/M.P.I. Alpha/Bravo-502 Mag M.P.I. 7.4L M.P.I. Bravo Et MIE 8.1L/8.2L MIE M.P.I. MX6.2L M.P.I. Alpha/Bravo/Horizon Et MIE Black Scorpion Scorpion 377 Stendrive Racing (Sin rosca) Reemplaza la bomba de combustible fría (Non threaded) Replaces cool fuel pump



REF	OEM	
REC827682T	827682T 827682	262 MAG (TBI) (GEN+) 350 MAG EFI SKY (TBI) GM350 V-8 1994-1996 350MAG MPI SKY GM350 V-8 1995-1996 350 MAG ALPHA EFI (GEN+) GM350 V-8 1996 350 MAG BRAVO MPI GM350 V-8 1995 350 MAG BRAVO MPI (GEN+) GM350 V-8 1996 5.7L ALPHA EFI (TBI) GM350 V-8 1995 5.7L BRAVO (TBI) GM350 V-8 1995 5.7L EFI (2BBL-TBI) GM350 V-8 1996 5.7LX BRAVO EFI (GEN+) GM350 V-8 1996 5.7LX EFI (4BBL-TBI) GM350 V-8 1996



**MERCURISER**

**RECMAR**

REF	OEM	
REC866169T01	866169T01 305, 350, 377, 496 866169A01 5.0, 5.7, 6.2, 8.1, 8.2, 6.2L	

GM V-8 con módulo de alta presión Gen III.  
GM V-8 with Gen III cool fuel module high pressure.



REF	OEM	
REC8M0062770	8M0062770 4.5L MPI (2A456613+) 6.2L MPI (2A449153+)	



**BOMBA DE COMBUSTIBLE BAJA PRESIÓN**

**LOW PRESSURE FUEL PUMP**

REF	OEM	
REC3858261	805656A2 V6 - V8	8 PSI 25gpm
	805656A5 (Modelo antiguo   Old Model)	
	805025A2	
	861155A5 4.3Fi Et Carburated 1992-93	
	805656A6 861155A6 (Bomba en línea   Inline pump model)	



REF	OEM	
REC866170A01K	866170A01 305, 350, 377 Et 496 CID	

GM V-8 con módulo de baja presión Gen III.  
GM V-8 with Gen III cool fuel module low pressure.



REF	OEM	
CARP74021	12 Volt. 4-6PSI /20-30 GPH	

Poseen todas las medidas de seguridad exigidas. Puede usarse para trasvase de gasoil.  
Listed by Marine Division UL. Used for diesel fuel transfer



REF	OEM	
REC861155A6	861155A6	4.3L V-6
	861155A5	
	805656A6	
	805656A2	
	805656A5	
	805025A2	

Sustituye modelos antiguos.  
Replaces old models.



REF	
RECEFP-KT	



REF	OEM	
REC861155A3	861155A3 861155A2	4.3, 5.0 / 5.7, 8.1L V6 Et V8



MÓDULO DE COMBUSTIBLE COMPLETO

COMPLETE FUEL MODULE

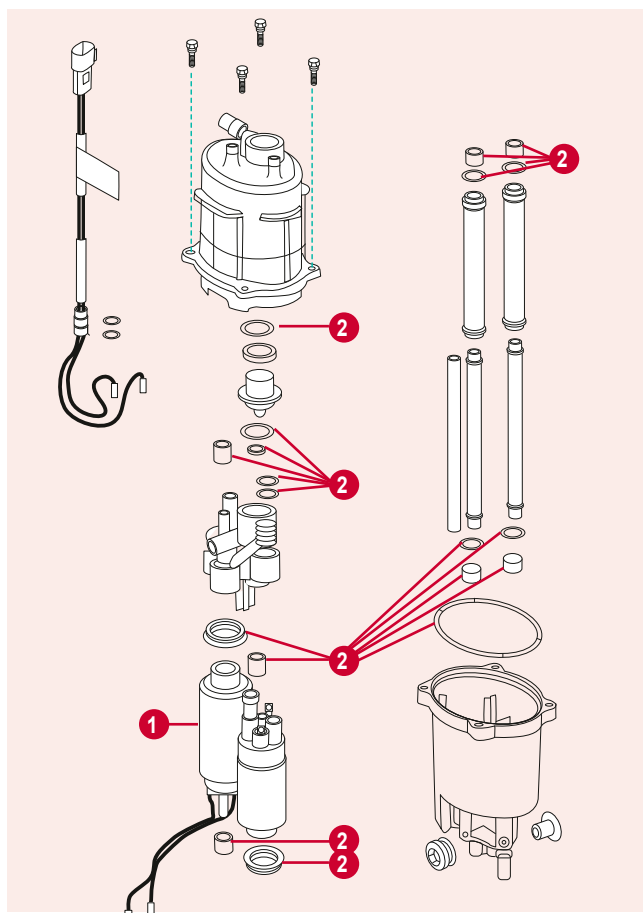
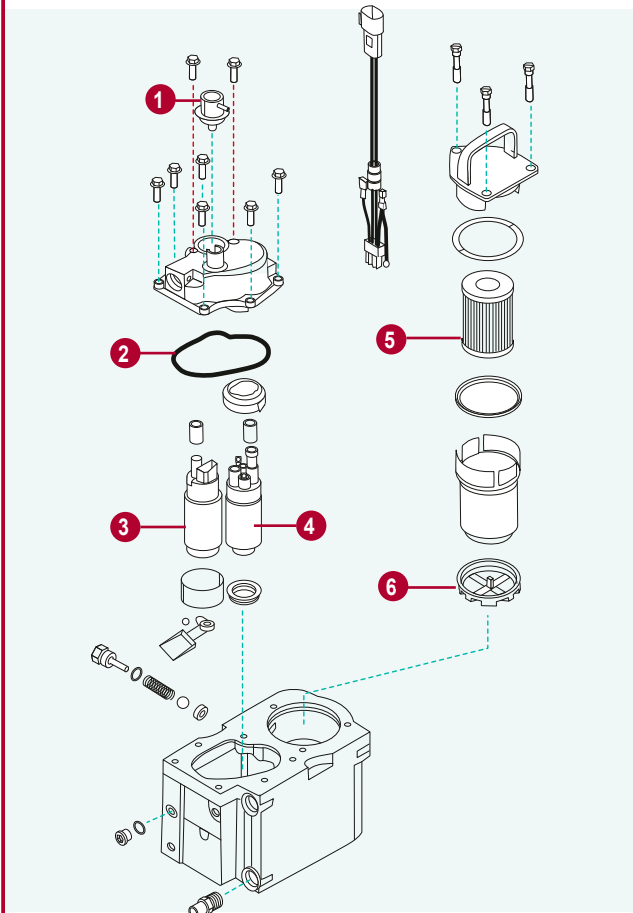

	REF	OEM		
1	REC892681	892681	REGULADOR	REGULATOR
2	REC26-892683	892683	JUNTA VST	VST GASKET
3	REC866169T01	866169Y01	BOMBA DE ALTA PRESIÓN	PUMP, HIGH PRESSURE
4	REC866170A01K	866170A01	BOMBA BAJA PRESIÓN	PUMP, LOW PRESSURE
5	REC35-866171A01	866171A01	FILTRO	FILTER
6	REC35-892665	892665	FILTRO GASOLINA	FUEL FILTER

	REF	OEM		
1	REC8M0062770	8M0062770	BOMBA DE ALTA PRESIÓN	PUMP, HIGH PRESSURE
2	REC8M0133370	8M0133370 8M0057679	KIT JUNTAS VST	GASKET VST, KIT

BOMBA DE COMBUSTIBLE Y KIT ENFRIADOR

ELECTRIC FUEL PUMP & COOLER

REF	OEM	
REC861156A03	861156A03	(#865356) 4.3 MPI, 5.0 MPI, 350 MAG MPI, MX6.2 MPI OM300000+



JUNTAS VST

VST GASKETS

REF	OEM
REC26-892683	26-892683



REF	OEM	
REC8M0133370	8M0133370 8M0057679	-2A575398 2A575399+ 4.5 & 6.2

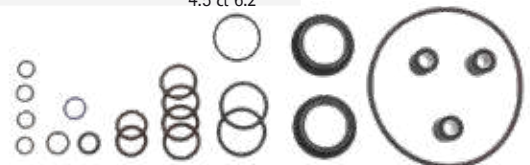

REGULADOR PRESIÓN DE COMBUSTIBLE

FUEL PRESSURE REGULATOR

ENFRIADOR DE COMBUSTIBLE

FUEL COOLER

REF	OEM	Icon	Color
REC860349A1	860349A1	MCM/MIE 7.4L/LX MPI 454 Mag MPI 502 Mag MPI MIE 8.2L MPI MCM 4.3 MPI	
REC861126A1	861126A1	5.0 MPI, 350 Magnum, 8.1 L 6.2 MPI 7.4 MPI	MARRÓN, AZUL/VERDE BROWN & BLUE/GREEN
REC807952A1	807952A1	MCM/MIE GM V-6 V-8 305, 350, 377 EFI/MPI, MCM 575SCi	ROSA PINK

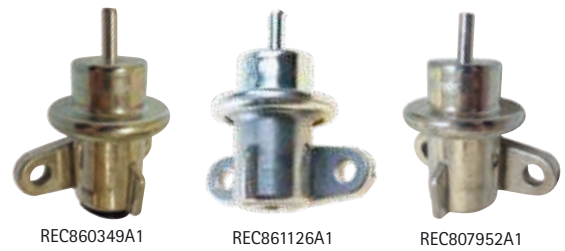

CARRIL DE COMBUSTIBLE

FUEL RAIL

REF	OEM	Icon
REC805227A1	805227A1	MCM/MIE 7.4L/LX MPI, 454 & 502 Mag MPI, 8.2L MPI



TAPA DEL MÓDULO

MODULE COVER

REF	OEM	Icon
REC892681	892681	5.0L MPI 5.7L MPI 350 Magnum 6.2L MPI 496 Magnum
		8.1L 8.2L 502 Mag MPI 375HP 425HP. 520, 540 (Race sterndrive)



INYECTORES

INJECTOR

INYECTOR

INJECTOR

REF	OEM	Icon
REC8M6002428	8M6002428 8M6000652 8M0057686	4.5L MPI (2A441953+) 6.2L MPI (2A456613+)



REF	OEM	Icon
REC885176	885176	MCM/MIE 4.3L MPI, 5.0L MPI, 350 Mag MPI, MX 6.2L MPI engines w/ECM555



REF	OEM	Icon
REC881693002	881693002	MCM 496 Mag & HO, MIE 8.1S & HO



REF	OEM	Icon
REC3858941	852956A1	MCM GM V6 & V8 (305 & 350 cid) TBI



CARBURADORES

CARBURETORS

BOYAS

FLOATS

REF	OEM	Icon
REC3302-9031	1397-5837 3302-9031	AQ175A AQ200D, F AQ500A



CARBURADORES

CARBURATORS

Q-JET

REF	OEM	CUERPOS BBL	
REC1347-816373A4	1347-816373A4	4	MCM 260, 350 MAG, 5.0L, 5.0LX, 5.7. (1982-95)
	1347-804624R02		
	3310-804624R1		
	1347-6492A1		
	1347-7362A1		
	1347-8292A4		
	1347-9662A4		
	1347-9415T		

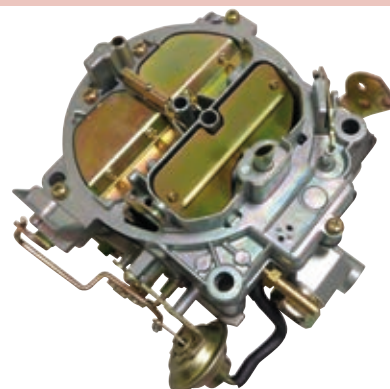

MERCARB

REF	OEM	CUERPOS BBL	
REC3310-864943A01	3310-864943A01	2	5.7 GM350 V8 (1998-01) 5.7 CARB ALPHA BRAVO 5.7 CARB MIE 5.7 CARB SKY 5.7 COMPETITION SKI (GEN+) GM 350 V8 (1998) 5.7L 1998+
	3310-861245A1		

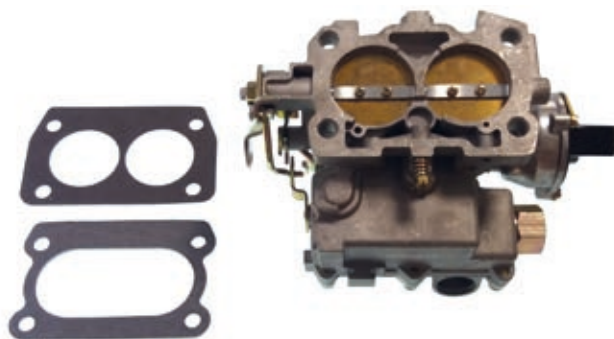

MERCARB

REF	OEM	CUERPOS BBL	
REC3310-864941A01	3310-864941A01	2	4.3L (2002-04) (OM615000- OW300012)



MERCARB

REF	OEM	CUERPOS BBL	
REC3310-860070A2	3310-860070A2	2	120, 140, 2.5 L & 3.0L
	1389-9562A1		
	3310-806077A2		
	3310-860070A2		
	3310-9562A1		
	3310-9350A2		
	3310-806078A2		
	3310-815396A2		

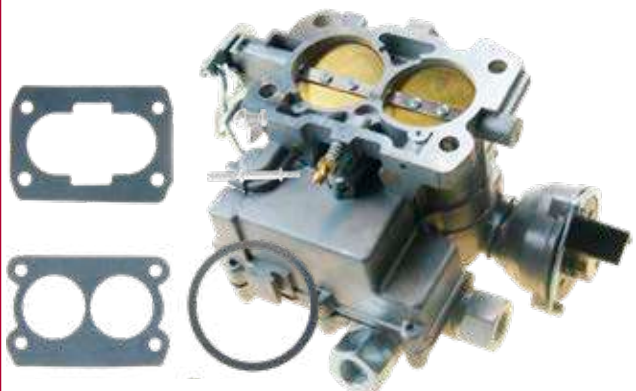

MERCARB

REF	OEM	CUERPOS BBL	
REC3310-864942A01	3310-864942A01	2	5.0L ALPHA/BRAVO (-OM623982) 5.0L ALPHA/BRAVO (OM623983+) 5.0L (1998-04)
	3310-861448A1		

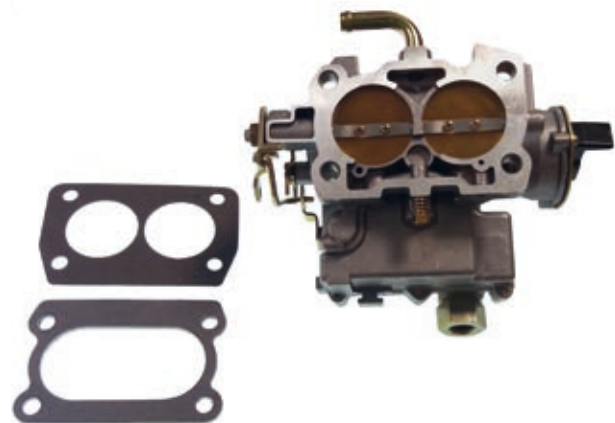

JUNTAS DE CARBURADOR

CARBURETOR GASKETS

ROCHESTER

REF	OEM
REC27-48399	27-48399

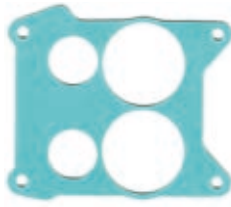

HOLLEY

REF	OEM	CUERPOS BBL
REC27-65577	27-65577	4



ROCHESTER

REF	OEM
REC27-60715	27-60715



ROCHESTER

REF	OEM	CUERPOS BBL
REC27-64692	27-64692	4

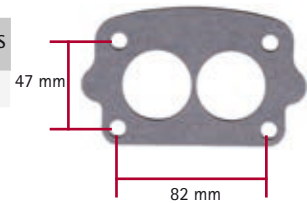

ROCHESTER & WEBER

REF	OEM	CUERPOS BBL
REC27-524572	27-524572	4
	8079821	
	27-8079821	
REC27-8079821	27-70143	2
	27-701431	
	27-807982	



REC27-524572

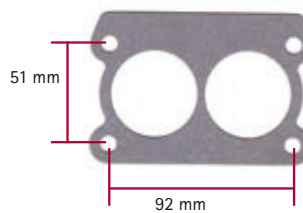

REC27-8079821

GUÍA CARBURADORES

GUIDE CARBURETORS

	CUERPOS BBL	SERIE SERIAL	CARB.	KIT CARB.	JUNTA BASE BASE GASKET	
<b>ROCHESTER</b>						
140 (GM181) L4	2	1968-78 02816417-09999999		REC823427A1	REC27-64692	
140 (GM181) L4	2	1979-82 5157669-6229717		REC823427A1	REC27-64692	
205 (4.3L/LX)	4	1987 0B527955-0B775129		REC823426A1	REC27-524572	
205 (4.3L)	4	1985-87 0A331455-0B527954		REC823426A1	REC27-524572	
4.3L /LX	4	1988-92 0B775130-0D714106		REC823426A1	REC27-524572	
898/200/5.0L	2	1987-95 0B525982-0F600999		REC3302-804845	REC27-8079821	
5.7L (2BBL)	2	1996-97 F601000-K999999		REC3302-804845	REC27-8079821	
5.7L SKI	2	1996-97 0F775200-0K999999		REC3302-804845	REC27-8079821	
260/5.7MIE	4	1987-93 0B522506-0F024999	REC1347-816373A4	REC823426A1	REC27-524572	
260	4	1978-86 4908850-0B525981	REC1347-816373A4	REC823426A1	REC27-524572	
260/5.7L ALPHA	4	1987-93 0B525982-0F000454	REC1347-816373A4	REC823426A1	REC27-524572	
5.7L BRAVO (w/o High Rise Intake)	4	1987-91 0B525982-0D617327	REC1347-816373A4	REC823426A1	REC27-524572	
5.7L SKI	4	1985-93 0A338533-0F025099	REC1347-816373A4	REC823426A1	REC27-524572	
300MR/TRS	4	1985-86 6668677-0B430367	REC1347-816373A4	REC823426A1	REC27-524572	
454 MAG ALPHA	4	1986-88 0A631894-0B785148		REC823426A1	REC27-524572	
<b>MERCARB &amp; WEBER</b>						
120 (CID 153/ CYL L4)		1984	REC3310-860070A2	REC3302-804845		
120 (CID 153/ CYL L4)		1985	REC3310-860070A2	REC3302-804845		
120 (CID 153/ CYL L4)		1986	REC3310-860070A2	REC3302-804844002		
2.5L (CID 153/ CYL L4)		1987-89	REC3310-860070A2	REC3302-804844002		
140 (CID 181/ CYL L4)		1984	REC3310-860070A2	REC3302-804845		
140 (CID 181/ CYL L4)		1985	REC3310-860070A2	REC3302-804845		
140 (CID 181/ CYL L4)		1986	REC3310-860070A2	REC3302-804844002		
3.0L (CID 181/ CYL L4)		1987-89	REC3310-860070A2	REC3302-804844002		
3.0L (CID 181/ CYL L4)		1990	REC3310-860070A2	REC3302-804844002		REC3302-804689
3.0L (CID 181/ CYL L4)		1991-93	REC3310-860070A2	REC3302-804844002		REC3302-804689
3.0L (CID 181/ CYL L4)		1993-94	REC3310-860070A2	REC3302-804844002		REC3302-804689
4.3LH (GEN+)	4	1998 0L010044-0M614999		REC809065	REC27-524572	
4.3L CARB ALPHA/BRAVO	2	0M615000-0W300012	REC3310-864941A01	REC3302-804844002	REC27-8079821	REC3302-804689
5.0L CARB ALPHA/BRAVO	2	0M600000 +	REC3310-864942A01	REC3302-804844002	REC27-8079821	REC3302-804689
5.0L GM305 V-8	2	1998 0L015751-0M599999	REC3310-864942A01	REC3302-804844002	REC27-8079821	REC3302-804689

	CUERPOS BBL	SERIE SERIAL	CARB.	KIT CARB.	JUNTA BASE BASE GASKET	KIT
5.7 CARB ALPHA/BRAVO	2	0M600000 +	REC3310-864943A01	REC3302-804844002	REC27-8079821	REC3302-804689
5.7L CARB MIE	2	0L002003-0W090899	REC3310-864943A01	REC3302-804844002	REC27-8079821	REC3302-804689
5.7L CARB SKY	2	0M317000-0W090899	REC3310-864943A01	REC3302-804844002	REC27-8079821	REC3302-804689
5.7L GM350V-8	2	1998-01 0L010037-0M599999	REC3310-864943A01	REC3302-804844002	REC27-8079821	REC3302-804689
5.7L COMPETITON SKY(GEN+)	2	1998 0L002005-0M316999	REC3310-864943A01	REC3302-804844002	REC27-8079821	REC3302-804689
7.4L MIE	4	1995-97 0F350000-0K999999		REC809064		REC811534
7.4L BRAVO I/II	4	1995-97 0F352000-0K999999		REC809064		REC811534
7.4L BRAVO III	4	1996-97 0F800700-0K999999		REC809064		REC811534
<b>TKS</b>						
5.0L CARB ALPHA/BRAVO	2	0M600000-0W300009		REC3302-804844002	REC27-8079821	REC3302-804689
5.0L CARB ALPHA/BRAVO	2	0W300010 +		REC3302-804844002	REC27-8079821	REC3302-804689
5.7L CARB ALPHA/BRAVO	2	0M600000-0W300009		REC3302-804844002	REC27-8079821	REC3302-804689
5.7L CARB ALPHA/BRAVO	2	0W300010 +		REC3302-804844002	REC27-8079821	REC3302-804689
5.7 CARB MIE	2	0M317000-0W689999		REC3302-804844002	REC27-8079821	REC3302-804689
5.7 CARB MIE	2	0W690000 +		REC3302-804844002	REC27-8079821	REC3302-804689
5.7 CARB SKY	2	0M317000-0W689999		REC3302-804844002	REC27-8079821	REC3302-804689
5.7 CARB SKY	2	0W694844 +		REC3302-804844002	REC27-8079821	REC3302-804689



**KIT JUNTAS DE CARBURADOR**

**CARBURETOR GASKETS KIT**

**ROCHESTER**

REF	OEM
REC823427A1	823427A1
	1397-8872/3
	1397-7542/7
	1397-3459
	1397-2634
	1397-2067



**MERCARB**

REF	OEM
REC1397-6367A1	1397-6367A1

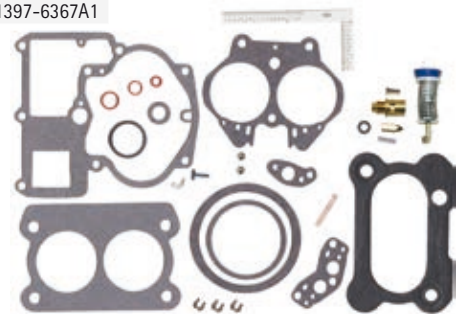

**ROCHESTER**

REF	OEM	CUERPOS BBL	
REC823426A1	823426A1	4	FORD 351, (1970-74)

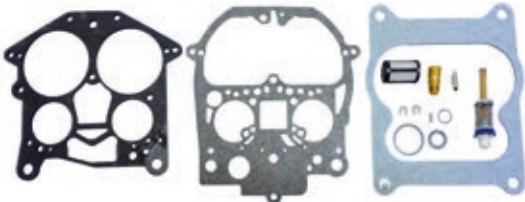

**HOLLEY**

REF	OEM
REC1396-4656	1396-4656

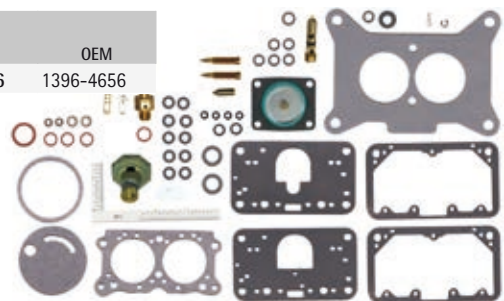

**WEBER**

REF	OEM	CUERPOS BBL
REC809064	809064	4
REC809065	809065	4
	835076	
	823728	

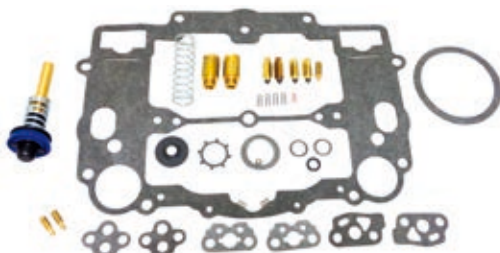

**HOLLEY**

REF	OEM	
REC1396-5238	1396-5238	FORD 351, (1970-74)
	1396-5222	



MERCAB

REF	OEM
REC3302-804844002	3302-804844002

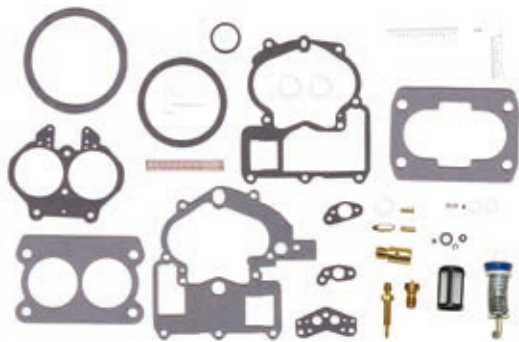

MERCAB

REF	OEM
REC3302-804845	3302-9437 3302-804845



KIT AGUJAS

WEBER

REF	OEM	Icon
REC811534	811534	V8



NEEDLE KIT

MERCAB

REF	OEM	Icon
REC3302-804689	3302-804689	Moderno New style

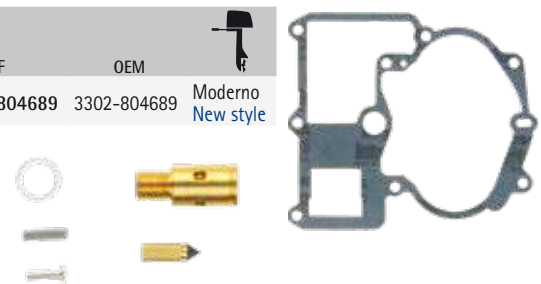

TUBO COMBUSTIBLE BOMBA --> CARBURADOR

REF	Normative
REC18-8114	3/8" X 31" PTFE - 5/8"
REC18-8115	3/8" X 25" PTFE - 5/8"

NORMATIVE SAE J1527



FUEL TUBE PUMP --> CARBURETOR



GUÍA KIT CARBURADORES

GUIDE CARBURETORS KIT

Icon	SERIE	OEM	CARB	KIT	JUNTA BASE BASE GASKET	Icon
MCM 120/2.5L	2520425-3377340	1336-3594A1	R2/2GC		REC27-64692	
	337341-3770649	1351-4263A3	R2/2GC	REC823427A1	REC27-64692	
	3770650-4469865	1351-5202A1	R2/2GC	REC823427A1	REC27-64692	
	4469866-5192048	1351-6065A2	R2/2GC	REC823427A1	REC27-64692	
	5192049-6229717	1351-7354A1	R2/2GC	REC823427A1	REC27-64692	
	6229718-0C853255	1351-8480A2	R2/2GC	REC823427A1	REC27-64692	
	6229718-0C853255	1389-8490A2	M2/MERCARB	REC3302-804844002	REC27-8079821	
	6229718-0C853255	1389-9350A2	M2/MERCARB	REC3302-804844002	REC27-8079821	
	6229718-0C853255	1389-9562A1	M2/MERCARB	REC3302-804844002	REC27-8079821	
	2816417-2911439	1351-4032A1	R2/2GC	REC823427A1	REC27-64692	
MCM 140/3.0L/3.0LX (4 Cil.)	2911440-3771644	1351-4293A1	R2/2GC	REC823427A1	REC27-64692	
	3771645-5157668	1351-5203A1	R2/2GC	REC823427A1	REC27-64692	
	5157669-6229717	1351-7355A1	R2/2GC	REC823427A1	REC27-64692	
	6229718-0C856556	1351-8480A2	R2/2GC	REC823427A1	REC27-64692	
	6229718-0C856556	1389-8490A2	M2/MERCARB	REC3302-804844002	REC27-8079821	
	6229718-0C856556	1389-9350A2	M2/MERCARB	REC3302-804844002	REC27-8079821	
	6229718-0C856556	1389-9562A1	M2/MERCARB	REC3302-804844002	REC27-8079821	
MCM 165/170/3.7L (4 Cil.)	0D447415-0D836075	1389-9562A1	M2/MERCARB	REC3302-804844002	REC27-8079821	
	6916779	1389-9564A1	M2/MERCARB	REC3302-804844002	REC27-8079821	
MCM470	4208730-6916778	1376-5990A1	R2/2GC	REC823427A1	REC27-8079821	
	6218037-6916778	1389-8489A5	M2/MERCARB	REC3302-804844002	REC27-8079821	
MCM185 (229CID)	6330183-6919655	3300-8886A 2	R4/4ME	REC823426A1	REC27-524572	
MCM485	5688394-6218036	1376-5990A1	R2/2GC	REC823427A1	REC27-64692	

	SERIE	OEM	CARB	KIT	JUNTA BASE BASE GASKET	 KIT
MCM180/190/3.7LX	6916779	1347-9142A2	R4/4ME	REC823426A1	REC27-524572	
MCM488	6170297-6916778	1347-8460A3	R4/4ME	REC823426A1	REC27-524572	
	0A221455-0B527954	3304-9353A2	M2/MERCARB	REC3302-804845	REC27-8079821	
MCM 175/185/4.3L V6	0A221455-0D714106	3304-9565A1	M2/MERCARB	REC3302-804844002	REC27-8079821	
	0F000878+	3310-80776A1	M2/MERCARB	REC3302-804844002	REC27-8079821	REC3302-804689
	0A331455-0D714369	3304-9354A2	R4/4MV	REC823426A1	REC27-524572	
MCM205/ 4.3LX/ 4.3LXH/LHV6	0D714370-0F802999	3310-807826A1	WEBER	REC809064	REC27-524572	
MCM898/200 V8	6218462-0B525981	1389-9563A1	M2/MERCARB	REC3302-804844002	REC27-8079821	
MCM200/5.0L V8	0B525982-0F600999	1389-9670A2	M2/MERCARB	REC3302-804844002	REC27-8079821	REC3302-804689
MCM5.0L (GENE+) V8	0L157751+	3310-861448A1	M2/MERCARB		REC27-8079821	REC3302-804689
MCM888 V8	3108723-4887829	1356-4642	H2/2300	REC1396-4656		
	4765100-5069430	1347-6427A1	R4/4MV	REC823426A1	REC27-524572	
MCM228/TR/MIE V8	4765100-5069430	1347-6438A1	R4/4MV	REC823426A1	REC27-524572	
	5069431-6021783	1347-7361A1	R4/4MV	REC823426A1	REC27-524572	
MCM228V8	6021784-6218461	1347-8296A4	R4/4MV	REC823426A1	REC27-524572	
MCM228/230/5.0LX	6218462-0F600999	1347-9661A3	R4/4MV	REC823426A1	REC27-524572	
MCM228MIE V8	5069431-6040745	1347-7364A1	R4/4MV	REC823426A1	REC27-524572	
MCM230MIE V8	6040746-0B788151	1347-8290A1	R4/4MV	REC823426A1	REC27-524572	
	4768000-4908849	1347-3353	R4/4MV	REC823426A1	REC27-48399	
MCM250 (350CID) V8	4768000-4908849	1347-3237A3	R4/4MV	REC823426A1	REC27-48399	
	4175500-4924564	1347-5732A1	R4/4MV	REC823426A1	REC27-524572	
	4924565-5195908	1347-7062A1	R4/4MV	REC823426A1	REC27-524572	
MCM255/MIE V8	5195909-5907057	1347-7365A1	R4/4MV	REC823426A1	REC27-524572	
	5907058-0B522505	1347-8289A1	R4/4MV	REC823426A1	REC27-524572	
MCM260MIE V8	0B522506-0F024999	1347-9662A4	R4/4MV	REC823426A1	REC27-524572	
MCM260MIE/ 5.7MIE	0F025000-0F349299	3310-806761A1	WEBER		REC27-524572	REC811534
	0F025000-0F349299	3310-806761A2	WEBER		REC27-524572	REC811534
MCM5.7MIE V8	0F349300-0F622099	3310-806761A3	WEBER		REC27-524572	REC811534
	0F622100-0K999999	3310-806762A2	WEBER		REC27-524572	REC811534
MCM5.7MIE (2BBL)	0L002003+	3310-861245A1	MERCARB		REC27-8079821	REC3302-804689
255 V8	4175500-4767999	1347-5732A 1	R4/4MV	REC823426A1	REC27-524572	
	4908850-5060805	1347-6492A 1	R4/4MV	REC823426A1	REC27-524572	
260 V8	5060806-6024393	1347-7362A 1	R4/4MV	REC823426A1	REC27-524572	
	6024393-0B525981	1347-8292A 1	R4/4MV	REC823426A1	REC27-524572	
260 V8/5.7L Alpha	0B525982-0F000454	1347-9662A 4	R4/4MV	REC823426A1	REC27-524572	
	0F000455-0F273497	3310-806761A 1	WEBER		REC27-524572	REC811534
5.7L Alpha V8	0F273498-0F600999	3310-806761A 3	WEBER		REC27-524572	REC811534
5.7L (2BBL) V8	0F601000-0K999999	3310-807312A 1	MERCARB		REC27-8079821	REC3302-804689
5.7L (Gen+) (2BBL)	0L010037+	3310-861245A1	MERCARB		REC27-8079821	REC3302-804689
5.7LX (4BBL) V8	0F601000-0K999999	3310-807262A 2	WEBER		REC27-524572	REC811534
	0B525982-0D617327	1347-9662A 4	R4/4MV	REC823426A1	REC27-524572	
5.7L Bravo V8	0B525982-0D617327	1347-8289A 1	R4/4MV	REC823426A1	REC27-524572	
	0B525982-0D617327	3310-806970A 1	WEBER		REC27-524572	REC811534
	0A635178-0D617327	1347-8289A 1	R4/4MV	REC823426A1	REC27-524572	
350 Magnum Alpha	0D617328-0F600999	3310-806970A 1	WEBER		REC27-524572	REC811534
	0F601000-0K999999	3310-807262A 2	WEBER		REC27-524572	REC811534
	0A338533-0F025099	1347-9415T	R4/4MV	REC823426A1	REC27-524572	
5.7L Ski V8	0F025100-0F449999	3310-806761A 2	WEBER		REC27-524572	REC811534
	0F450000-0F775199	3310-806761A 3	WEBER		REC27-524572	REC811534
5.7L Ski (2BBL) V8	0F775200-0K999999	3310-807312A 1	MERCARB		REC27-8079821	REC3302-804689
5.7L Ski (Gen+)(2BBL) V8	0L002005+	3310-861245A 1	MERCARB		REC27-8079821	REC3302-804689
	0D505450-0K999999	3310-807262A 2	WEBER		REC27-524572	REC811534
350 MAG Ski V8	0K040400-0K999999	3310-860371A 1	WEBER		REC27-524572	REC811534
	2851074-3385720	1347-4180A 1	R4/4MV	REC823426A1	REC27-524572	
270 MCM/MIE V8	4176250-4176468	1347-4179A 2	R4/4MV	REC823426A1	REC27-524572	
280 TRS V8	4176469-4770199	1347-5981A 1	R4/4MV	REC823426A1	REC27-524572	
300 MR/TRS V8	6668677-0B430367	1347-7498A 7	R4/4MV	REC823426A1	REC27-524572	
	2278747-3042730	1347-3342	R4/4MV	REC823426A1	REC27-524572	
325 MCM/MIE V8	3042731-3780449	1347-4533A 1	R4/4MV	REC823426A1	REC27-524572	
	2278747-3080449	1347-3689A 1	R4/4MV	REC823426A1	REC27-524572	
	4623115-5027230	1347-6493A 1	R4/4MV	REC823426A1	REC27-524572	
330 MCM V8	5027231-6083144	1347-7363A 1	R4/4MV	REC823426A1	REC27-524572	
	6083145-0B816540	1347-8291A 3	R4/4MV	REC823426A1	REC27-524572	
330 MIE V8	4623115-5226384	1347-6493A 1	R4/4MV	REC823426A1	REC27-524572	
	5226385-5889913	1347-7366A 1	R4/4MV	REC823426A1	REC27-524572	
340/7.4L MIE V8	5889914-0D715493	1347-8288A 1	R4/4MV	REC823426A1	REC27-524572	
7.4L Hurth V8	0D715494-0F349999	3310-80969A 2	WEBER		REC27-524572	REC811534
7.4L BORG WARNER V8	0D715494-0F349999	3310-80969A 3	WEBER		REC27-524572	REC811534
7.4L MIE V8	0F350000-0K999999	3310-86969A 1	WEBER		REC27-524572	REC811534

	SERIE	OEM	CARB	KIT	JUNTA BASE BASE GASKET	KIT
7.4L BRAVO I/II V8	OB771113-OD603117	1347-8291A 3	R4/4MV	REC823426A1	REC27-524572	
	OD603118-OF351999	3310-86969A 2	WEBER		REC27-524572	REC811534
	OF352000-OK999999	3310-86969A 1	WEBER		REC27-524572	REC811534
7.4L BRAVO III V8	OD838819-OF800699	3310-806755A 2	WEBER		REC27-524572	REC811534
	OF800700-OK999999	3310-806969A 1	WEBER		REC27-524572	REC811534
370 V8	4179554-OB714586	1347-7498A 2	R4/4MV	REC823426A1	REC27-524572	
400 V8	TODOS - All	1347-7498A 2	R4/4MV	REC823426A1	REC27-524572	
454 MAG Alpha V8	OA631894-OB785148	1347-8291A 3	R4/4MV	REC823426A1	REC27-524572	
	OA631894-OB785148	1347-8291A 3	R4/4MV	REC823426A1	REC27-524572	
454 MAG Bravo V8	OB721206-OD808068	1347-7498A 2	R4/4MV	REC823426A1	REC27-524572	
	OD808069-OF304999	3310-806755A 1	WEBER		REC27-524572	REC811534
	OF305000-OK999999	3310-806755A 2	WEBER		REC27-524572	REC811534
502 MAG V8	OC878221-OD824588	1347-814623A 2	R4/4MV	REC823426A1	REC27-524572	
	OD824589-OF114528	3310-806971A 1	WEBER		REC27-524572	REC811534
8.2L MIE V8	OC878221-OD857199	1347-814623A 2	R4/4MV	REC823426A1	REC27-524572	
	OD878221-OF819619	3310-806971A 1	WEBER		REC27-524572	REC811534

TURBO

TURBO

TURBO

TURBO

REF	OEM			
REC8M0098619	8M0098619 889341	CMD CMDQ 4.2 D4.2L / 300 D-TRONIC	REC27-8M0094247	RM21325765



KIT JUNTAS PARA TURBO

TURBO GASKET KIT

REF	OEM	TURBO
REC27-8M0094247	24-8M0094247	
	27-898101475	REC8M0098619
	27-801333454	
	27-854129	

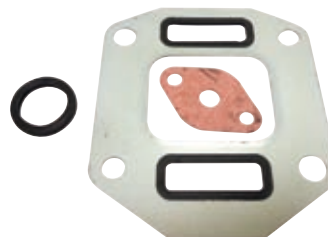

ABRAZADERA ESCAPE TURBO

TURBO, EXHAUST CLAMP

REF	OEM	
RM21325765	864148A01	D/CMD/QSD
	54-896332164	1.7 / 2.0 / 3.0 / 3.6 / 2.8 / 4.2
	801763272	D183, 219, 254, 530, 636
	801331174	7.3L
	864148	



RETÉN ACEITE DE TURBO

TURBO, SEAL

REF	OEM	
REC27-8M0094247	811461	2.8 / 4.2 D254







## SENSORES

## SENSORS

### SENSOR TPS

### TPS SENDER

REF	OEM	
REC8M0125617	8M0125617	
	881070T	
	805226A1	



REF	OEM	
REC853678T	853678T	
	853678	

REF	OEM	
REC803148	803148	MCM/MIE 350 Mag, Blk Scorpion Ski (0L005900 Et +)





### SENSOR MAP



### MAP SENSOR

REF	OEM	
REC8M0054726	881731	
	8M0054726	

REF	OEM	
REC854445	854445	MCM 525 EFI



REF	OEM	
REC3850396	864856A1	
	805217A1	

REF	OEM	
REC861249A1	861249A1	
	861249	

### SENSOR MAT/MAP



### MAT/MAP SENSOR

REF	OEM	
REC8M0087834	885165 8M0087834	350MAG MPI
		377MAG MPI
		383MAG STROKER
		4.3L MPI
		5.0L MPI
		5.7L MPI
		6.2L MPI



### SENSOR PICK UP

### PICK UP SENSOR

REF	OEM	
REC3854001	811639	
	811639T	

**SENSOR DE OXÍGENO**

**OXYGEN SENSOR**

REF	OEM	
REC8M2003959	8M2003959	3.0 MPI, 4.3 MPI, 4.5 MPI, 6.2 MPI, 5.0L MPI, 5.7L MPI 8.2/377



REF	OEM	
REC8M0142695	8M0142695 8M0095468	4.5 MPI, 6.2 MPI



**VÁLVULA DE AIRE, IAC**

**AIR VALVE, IDLE**

REF	OEM	
REC862998	862998	3.0L MPI, 4.3 MPI, 5.0L MPI, 350 MAG MPI, MX6.2 MPI, 8.1L 600, 662, 700 (Race sterndrive)



**SENSOR IAC**

**IAC SENDER**

REF	OEM	
REC3855194	805224A1	MCM/MIE GM V-6 & 305, 350, 454, 502 EFI 500, 575 (Race sterndrive)



REF	OEM	
REC3843751	803149	MCM/MIE 350 Mag MPI Black Scorpion Ski, 377 Scorpion, MCM & Ski MX 6.2L MPI, 7.4L MPI (L29), 575SCi



**SENSOR PICADO**

**KNOCK SENDER**

REF	OEM	
REC8M0077616	805544T 8M0077616	454, 502, 540, 572 7.4L, 454 MAGNUM 8.2L 500, 525, 575, 600, 800 (Race sterndrive)



REF	OEM	
REC806612T	806612T	MCM/MIE 305, 350, 377 GM V8 CID



REF	OEM	
REC8M6003194	8M6003194 878187	V6 & V8



**SENSOR POSICIÓN ÁRBOL DE LEVAS**

**CAMSHAFT SENSOR**

REF	OEM	
REC3863130	898141	3.0, 4.3, 5.0, 5.7, 6.2L

Se instala en distribuidor  
Is installed in distributor



## SENSOR POSICIÓN CIGUENAL

REF	OEM	
REC892617	892617	8.1L 496 Mag. H.O. BRAVO

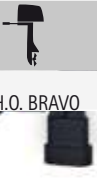

## CRANKSHAFT SENSOR

REF	OEM	
REC864297T01	864297T01 864297 864297001	350 Magnum, 377 Magnum MPI, 5.0L MPI, 5.7L MPI, 6.2L MPI, 8.2L MPI 4.3L CARB / MPI 525, 600, 662, 700 (Race sterndrive)



## KIT SENSOR TRIM

REF	OEM	
REC805320A03	805320A03	MC-1, MR, ALPHA ONE, GEN II & BRAVO



## TRIM SENSOR KIT

## KIT SENSOR DIGITAL TRIM

REF	OEM	
REC8M0095310	8M0095310	ALPHA ONE GEN II (1998+) BRAVO I,II, III (2A417474+)



## DIGITAL TRIM SENDER

## SENSOR PRESIÓN DE ACEITE

REF	OEM		<b>A</b>
REC8M0068784	87-815425T 8M0068784 90806 815425 34623	1/8 - 27	10 - 31



## OIL PRESSURE SENDER

REF	OEM	
REC87-805605A1	87-805605A1	3.0L (1990-95) 4.3L (1993-98) 5.0L (1988-01) 5.7L (1988-01) 7.4L (1991-00)



REF	OEM	
REC8M6000634	8M6000634 897447002 889659002	4.5L MPI 6.2L MPI



REF	OEM		PSI
REC881879T11	881879T11 881879A6 859210 859210T 859604A1 881879011	4.3, 5.7, 6.2, 8.2 MPI 8.1, 496, 520, 540	0-100



**SENSOR PRESIÓN ACEITE RAIL**

**OIL PRESSURE SENDER RAIL**

REF	OEM	
REC3843100	879172105	CMD QSD 2.8, 4.2 2.0L EI, ES



**SENSOR ACEITE PARA BOMBA COMBUSTIBLE**

**ELECTRIC FUEL PUMP SWITCH SENSOR**

REF	OEM	
REC87-864252	87-864252	4.3, 5.0, 5.7 Motores modernos Later engines



REF	OEM	
REC87-864252A01	87-864252A01	4.3, 5.0, 5.7 Motores antiguos Old engines



**SENSOR DE TEMPERATURA AIRE**

**AIR TEMPERATURE SENSOR**

REF	OEM	
REC805223T	805223T 805223	V6 Et V8 (350, 454, 496 Et 502 CID) EFI / MPI 500, 520, 525, 540, 575 (Race sterndrive)



**SENSOR CAUDAL DEL AGUA**

**WATER SENSOR**

REF	OEM		PSI
REC8M6000623	8M6000623 881879010 8818793	V6 Et V8 4.5L MPI	50



**SENSOR TEMPERATURA ENFRIADOR**

**COOLANT TEMPERATURE SENDER**

REF	OEM	
REC3850397	805218T 805218	350 MAG ,PI 383 MAG 4.3L MPI, 5.0L MPI, 3.0L MPI 6.2L MPI
		357, 377 4.3 CARB, EFI 454, 496 MAG, EFI 5.7L CARB, EFI 8.1, 8.2L MIE

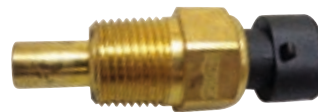

**SENSOR TEMPERATURA AGUA**

**WATER TEMPERATURE SENDER**

REF	OEM	
REC97258A1	97258A1 97258 34625 FI6900198 FI6900152	1/2" - 14 NPT



REF	OEM	
REC806490T	806490T 97257A1 97-257 806490 811091 36525	3/8" - 18 NPT



REF	OEM
REC48952	48952



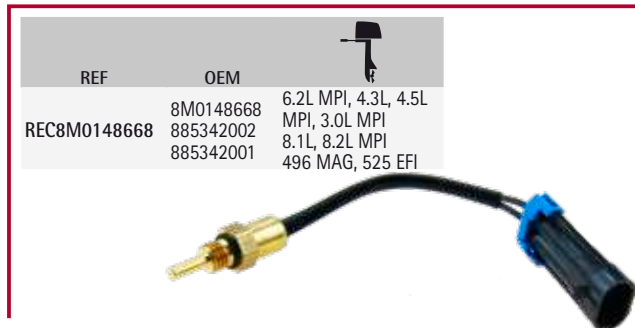
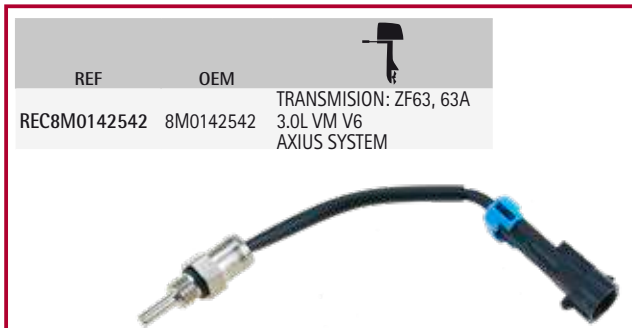

## GUÍA DE SENSORES SENSOR APPLICATION

MOD.	CYL	SERIE SERIAL	INYECTOR INJECTOR	KIT	IAC	TPS	REGULADOR PRESIÓN REGULATOR PRESSURE		MAP	PICADO KNOCK	TEMP. AIRE AIR TEMP.
							RAIL	COOLER			
262 MAG EFI	262/V6	1996-97		REC3858941	REC3855194	REC8M0125617		REC807952A1	REC3850396		
4.3L EFI	262/V6	1998-01		REC3858941	REC3855194	REC8M0125617		REC807952A1	REC861249A1		REC805223T
4.3L MPI	262/V6	2002-07	REC885176		REC862998	REC853678T		REC807952A1			REC3850397
5.0L EFI	305/V8	1998-01			REC3855194	REC8M0125617		REC807952A1	REC861249A1		REC805223T
5.0L MPI	305/V8	2002-07	REC885176		REC862998	REC853678T		REC861126A1			
5.0L MPI DTS	305/V8	2005-07	REC885176								
320 EFI	350/V8	1987-89			REC862998						
350 MAG ALPHA EFI (GEN+)	350/V8	1996-97			REC3855194	REC8M0125617		REC807952A1	REC3850396	REC806612T	
350 MAG BRAVO MPI	350/V8	1995-96			REC3855194	REC8M0125617			REC3850396	REC806612T	
350 MAG BRAVO MPI (GEN+)	350/V8	1997			REC3855194	REC8M0125617		REC807952A1	REC3850396	REC806612T	
	350/V8	1994-96			REC3855194	REC8M0125617			REC3850396	REC806612T	
350 MAG EFI SKI	350/V8	1996			REC3855194	REC8M0125617		REC807952A1	REC3850396	REC806612T	
	350/V8	1997			REC3855194	REC8M0125617		REC807952A1	REC3850396	REC806612T	
	350/V8	1998			REC3843751	REC853678T		REC807952A1	REC861249A1	REC806612T	
	350/V8	1998			REC3843751	REC853678T		REC807952A1	REC861249A1	REC806612T	
350 MAG MPI	350/V8	1999			REC3843751	REC803148		REC807952A1	REC861249A1	REC806612T	REC805223T
	350/V8	1999-01			REC3843751	REC803148		REC807952A1	REC861249A1	REC806612T	REC805223T
	350/V8	2002-07	REC885176		REC862998	REC853678T		REC861126A1			
350 MAG MPI DTS	350/V8	2005-07	REC885176								
350 MAG MPI HORIZON	350/V8	2002-07	REC885176		REC862998	REC853678T		REC861126A1			
350 MAG MPI HORIZON DTS	350/V8	2005-07	REC885176								
	350/V8	1999-01			REC3843751	REC803148		REC807952A1	REC861249A1	REC806612T	
350 MAG MPI HORIZON MIE	350/V8	2002-04	REC885176		REC862998	REC853678T		REC861126A1			
	350/V8	2004-07	REC885176		REC862998	REC853678T					
350 MAG MPI HORIZON MIE DTS	350/V8	2005-07	REC885176								
	350/V8	1998			REC3843751	REC853678T		REC807952A1	REC861249A1	REC806612T	
350 MAG MPI MIE	350/V8	2002-04	REC885176		REC862998	REC853678T		REC861126A1			
	350/V8	2004-07	REC885176		REC862998	REC853678T					
350 MAG MPI MIE DTS	350/V8	2005-07	REC885176								
	350/V8	1994-96			REC3855194	REC8M0125617			REC3850396	REC806612T	
	350/V8	1998			REC3843751	REC853678T		REC807952A1	REC861249A1	REC806612T	
350 MAG MPI SKI	350/V8	1999-01			REC3843751	REC803148		REC807952A1	REC861249A1	REC806612T	
	350/V8	2002-07	REC885176		REC862998	REC853678T		REC861126A1			
5.7L EFI	350/V8	1995-97			REC3855194	REC8M0125617		REC807952A1	REC3850396	REC806612T	
	350/V8	1998-01			REC3855194	REC8M0125617		REC807952A1	REC861249A1	REC806612T	REC805223T
5.7L EFI (GEN+)	350/V8	1997			REC3855194	REC8M0125617		REC807952A1	REC3850396	REC806612T	
	350/V8	1996-97			REC3855194	REC8M0125617		REC807952A1	REC3850396	REC806612T	
5.7LX BRAVO EFI (GEN+)	350/V8	1995-97			REC3855194	REC8M0125617		REC807952A1	REC3850396	REC806612T	
	350/V8	1996			REC3843751	REC853678T			REC3850396	REC806612T	
	350/V8	1997			REC3843751	REC853678T		REC807952A1	REC3850396	REC806612T	
BLACK SCORPION SKI	350/V8	1998			REC3843751	REC853678T		REC807952A1		REC806612T	
	350/V8	1998-05			REC3843751	REC803148		REC807952A1		REC806612T	
	350/V8	2003-07			REC862998	REC803148		REC807952A1			

MOD.	CYL	SERIE SERIAL	INYECTOR INJECTOR	KIT	IAC	TPS	REGULADOR PRESIÓN REGULADOR PRESSURE RAIL	COOLER	MAP	PICADO KNOCK	TEMP. AIRE AIR TEMP.
377 SCORPION MCM	377/V8	1999-05	OL416146-OM907201		REC3843751	REC803148		REC807952A1	REC3850396	REC806612T	
377 SCORPION SKI	377/V8	1997-98	OK000656-OL600314		REC3843751	REC853678T		REC807952A1	REC3850396	REC806612T	
	377/V8	2000-01	OL68003-OM299999		REC3843751	REC803148		REC807952A1	REC861249A1	REC806612T	REC805223T
MX 6.2L MPI	377/V8	2002-04	OM300000-OW059999	REC885176	REC862998	REC853678T		REC861126A1			
	377/V8	2004-07	OW060000+	REC885176	REC862998	REC853678T					
MX 6.2 MPI DTS	377/V8	2005-07	OW310000+	REC885176							
MX 6.2L MPI HORIZON	377/V8	2002-04	OM300000-OW059999	REC885176	REC862998	REC853678T		REC861126A1			
	377/V8	2004-07	OW060000+	REC885176	REC862998	REC853678T					
MX 6.2L MPI HORIZON DTS	377/V8	2005-07	OW310000+	REC885176	REC862998						
MX 6.2L MPI HORIZON MIE	377/V8	2002-04	OM300000-OM398394	REC885176	REC862998	REC853678T		REC861126A1			
	377/V8	2004-07	OM398395+	REC885176	REC862998	REC853678T					
MX 6.2L MPI HORIZON MIE DTS	377/V8	2005-07	OW390000+	REC885176							
MX 6.2L MPI MIE	377/V8	2002-04	OM300000-OM398394	REC885176	REC862998	REC853678T		REC861126A1			
	377/V8	2004-07	OM398395+	REC885176	REC862998	REC853678T					
MX 6.2L MPI MIE DTS	377/V8	2005-07	OW390000+	REC885176	REC862998						
MX 6.2L MPI SKI	377/V8	2002-07	OM317000+OL005601-OM391599	REC885176	REC862998	REC853678T		REC861126A1			
MX 6.2L BLACK SCORPION SKI	377/V8	2001-03	OK391750+		REC3843751	REC803148		REC807952A1		REC806612T	
	377/V8	2003-07	OF115700-OF802349		REC862998	REC803148		REC807952A1			
454 MAG EFI	454/V8	1994-96	OF215800-OF820099		REC3855194	REC8M0125617	REC805227A1		REC3850396	REC8M0077616	REC805223T
	454/V8	1994-96	OF820099-OK999999		REC3855194	REC8M0125617	REC805227A1		REC3850396	REC8M0077616	REC805223T
	454/V8	1996-97	OF820099-OK999999		REC3855194	REC8M0125617	REC805227A1		REC3850396	REC8M0077616	REC805223T
	454/V8	1996-97	OF802350-OK147349		REC3855194	REC8M0125617	REC805227A1		REC3850396	REC8M0077616	REC805223T
454 MAG MPI	454/V8	1996-97	OK147350-OL085399		REC3855194	REC8M0125617	REC805227A1	REC860349A1	REC3850396	REC8M0077616	
	454/V8	1997-98	OL085400-OM024999		REC3855194	REC8M0125617		REC861126A1	REC3850396	REC8M0077616	
454 MAG MPI HORIZON MIE	454/V8	1999-01	OL002200-OL086049		REC3855194	REC8M0125617	REC805227A1	REC860349A1	REC3850396	REC8M0077616	
	454/V8	1998	OL086050-OL674000		REC3855194	REC8M0125617		REC861126A1	REC3850396	REC8M0077616	
7.4L MPI (L29)	454/V8	1999-01	OL010003-OM024330		REC3843751	REC853678T		REC861126A1	REC861249A1	REC8M0077616	REC805223T
	454/V8	1998-01	OF050302-OK147349		REC3855194	REC8M0125617	REC805227A1		REC3850396	REC8M0077616	REC805223T
7.4L MPI MIE	454/V8	1995-96	OK147350-OK999999		REC3855194	REC8M0125617	REC805227A1	REC860349A1	REC3850396	REC8M0077616	
	454/V8	1997	OL010003-OL674613		REC3843751	REC8M0125617		REC861126A1	REC861249A1	REC8M0077616	REC805223T
7.4L MPI MIE (L29)	454/V8	1997	OF820000-OK999999		REC3855194	REC8M0125617		REC807952A1	REC3850396	REC8M0077616	REC805223T
7.4LX TBI	454/V8	1998-01	OF820000-OK999999		REC3855194	REC8M0125617		REC807952A1	REC3850396	REC8M0077616	REC805223T
	454/V8	1996-97	OF602010-OK147349		REC3855194	REC8M0125617	REC805227A1		REC3850396	REC8M0077616	REC805223T
7.4LX MPI	454/V8	1996	OK147350-OK999999		REC3855194	REC8M0125617	REC805227A1	REC860349A1	REC3850396	REC8M0077616	REC805223T
496 MAG	496/V8	1997	OM025000-OW059999	REC881693002	REC862998	REC853678T		REC861126A1			
	496/V8	2001-04	OW060000+	REC881693002	REC862998	REC853678T	N.S.S.	REC892681	REC8M0054726		
496 MAG DTS	496/V8	2004-07	OM025000-OW059999	REC881693002				REC861126A1			
	496/V8	2001-04	OW060000+	REC881693002			N.S.S.		REC8M0054726		
496 MAG HO	496/V8	2004-07	OM025000-OW059999	REC881693002	REC862998	REC853678T		REC861126A1			REC805223T
	496/V8	2001-04	OW060000+	REC881693002	REC862998	REC853678T	N.S.S.		REC8M0054726		REC805223T
496 MAG HO DTS	496/V8	2004-07	OM025000-OW059999	REC881693002				REC861126A1			REC805223T
	496/V8	2001-04	OW060000+	REC881693002			N.S.S.		REC8M0054726		REC805223T
8.1L MIE	496/V8	2004-07	OM026000-OW059999	REC881693002	REC862998	REC853678T		REC861126A1			REC805223T
	496/V8	2001-04	OW090000+	REC881693002	REC862998	REC853678T	N.S.S.	REC892681	REC8M0054726		REC805223T
8.1L HO MIE	496/V8	2004-07	OM026000-OW089999	REC881693002	REC862998	REC853678T		REC861126A1			REC805223T
	496/V8	2001-04	OW090000+	REC881693002	REC862998	REC853678T	N.S.S.	REC892681	REC8M0054726		REC805223T
500 EFI	502/V8	2004-07	OL001477+OD840650-OK147349		REC3855194	REC8M0125617	REC805227A1		REC3850396	REC8M0077616	
	502/V8	1999-05	OK147349-OK147350-OL085432		REC3855194	REC8M0125617	REC805227A1	REC860349A1	REC3850396	REC8M0077616	REC805223T
502 MAG MPI	502/V8	1993-96	OK147350-OL085432-OM024999		REC3855194	REC8M0125617	REC805227A1	REC861126A1	REC3850396	REC8M0077616	REC805223T
	502/V8	1997-98			REC3855194	REC8M0125617		REC861126A1	REC3850396	REC8M0077616	REC805223T
525 EFI	502/V8	1999-01	OM900146+		REC3855194	REC8M0125617		REC861126A1	REC854445		
575 SCI	502/V8	2003-07	OL306696-OM950526		REC3855194	REC8M0125617		REC807952A1		REC8M0077616	REC805223T
	502/V8	00-05	OF819620-OK147349		REC3855194	REC8M0125617	REC805227A1		REC3850396	REC8M0077616	
	502/V8	1996	OK127350-OL086012		REC3855194	REC8M0125617	REC805227A1	REC860349A1	REC3850396	REC8M0077616	
8.2 MPI MIE	502/V8	97-98	OL086013-OL674200		REC3855194	REC8M0125617		REC861126A1	REC3850396	REC8M0077616	

# MOTORES DE ARRANQUE

# STARTERS

REF	OEM				
REC50-8M0095471	50-8M0095471	12V	11 CW	14"	4.5L MPI 2A441953+ 6.2L MPI 2A456613+

REF	OEM
REC10-861788	10-861788



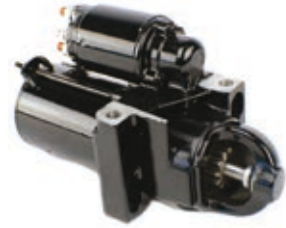

Motor de arranque para substituir a todos los motores de tamaño pequeño con tornillos fijación en diagonal excepto los 7.4L Starter to replace all the little engines with diagonally fixation screws excepting 7.4L.

REF	OEM				
REC50-863007A1	50-863007A1	12V 1.4 kW	11	14"	REC3859054 4 cyl V6 Et V8 3.0L

REF	OEM
REC10-861788	10-861788





Motor de arranque Heavy Duty. Tornillos de fijación en diagonal. Starter with diagonally fixation screws.

REF	OEM				
REC3885317	50-864340A2	12V 1.7 kW	11	14"	RECPG260 V6 Et V8 7.4L

REF	OEM
REC10-861788	10-861788



REF	OEM				
REC50-8M0095471	50-8M0095471	12V	11 CW	14"	4.5L MPI 2A441953+ 6.2L MPI 2A456613+

REF	OEM
REC10-861788	10-861788





Tornillos de fijación en diagonal. Starter with diagonally fixation screws.

REF	OEM				
REC50-99418A2	50-864340A2 50-99418A2	12V	9	14 <sup>1/4"</sup>	REC3853869 V6 Et V8

REF	OEM
REC10-861788	10-861788







REF	OEM				
REC3854190	50-69865A1 50-12782 50-56886	12V	10	REC0987883	FORD 5.0 Et 5.8L



Rotación estándar





Standard rotation

REF	OEM			
REC50-808011A05	50-808011A05 50-88671A1 50-80811A4	12V 1.4 kW	9	4, 6 & 8 cyl 5.7 MIE / 6.2 MIE.



Motor de arranque pequeño 4 en línea.





Starter Clockwise for 4L.

REF	OEM					
REC50-806965A4	50-863007A1 50-806963A2 50-806965A4	12V 1.4 kW	9	12 <sup>3/4</sup> "	REC3859054	3.0L



	OEM
MP0180-001	10-812509184
REC10-861788	10-861788



REF	OEM					
REC50-8M0090697	50-812429A2 50-806965A2 50-806965A4 50-8M0090697	12V 1.4 kW	11	12 <sup>3/4</sup> "	REC3859054	3.0L

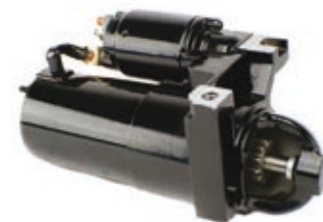





	OEM
MP0180-001	10-812509184
REC10-861788	10-861788



Modelo antiguo. Motor de arranque 4 en línea. Tornillos sujeción misma altura



Old style. Starter heavy duty standard rotation 4 inline. In line mounting holes.

REF	OEM				
REC50-99417A2	50-806965A4 50-99417A2	12V	9	REC3853869	V6 & V8



	OEM
MP0180-001	10-812509184
REC10-861788	10-861788





REF	OEM			
REC3916854	50-805991	12V	10	7.3L BRAVO & MIE DIESEL NAV444 V8 (1994-96) 6.9L



Motor de arranque 4 en línea modelo 470.

Starter clockwise 4 in line 470 mod. and engines with transmission.

REF	OEM			
REC50-97499A2	50-72550A2 50-47454 50-65785A1 50-79604A3	12V 1.4 kW	9	4, 6 & 8 cyl



# ALTERNADORES Y REGULADORES





# ALTERNATORS & VOLTAGE REGULATORS

## ALTERNADORES

## ALTERNATORS

REF	OEM				REG.	
REC69729	78403A2 59755 69729 56045	12V 61A	SIMPLE SINGLE	1	AUTOEXCITANTE SELF-EXCITING	CMD QSD 2.0/2.8 & 4.2 2.0L EI





REF	OEM				REG.	
REC78403A2	817119A4 78402 78403A1 78403A32 92497A3	12V 63A	SIMPLE SINGLE	2	AUTOEXCITANTE SELF-EXCITING	3.0/V6 & V8





REF	OEM			REG.	
REC862031T1	862031T1 862031 862031T	12V 70A	6 (65 mm) SERPENTÍN GROOVE PULLEY	INTERNO INTERNAL	4.3 & 5.7L (1997+)





REF	OEM			REG.	
REC3860769	817119A4 98555 12449 19685 817119 817119A1	12V 55A	SIMPLE SINGLE	INTERNO INTERNAL	4.3 & 5.7L (1998+)





REF	OEM			REG.	
REC805884T	805884T 805884 805447T	12V 65A	SIMPLE SINGLE	INTERNO INTERNAL	EFI & diesel





REF	OEM			REG.	
REC862030T01	862030T01 862030T	12V 70A	SIMPLE SINGLE	INTERNO INTERNAL	3.0L (1999+)





REF	OEM			REG.	
REC807653T	807653T 807653	12V 65A	6 SERPENTÍN GROOVE PULLEY	INTERNO INTERNAL	V6 Et V8 (MANDO)



REF	OEM			REG.	
REC807652T	807652T 807652	12V 55A	6 SERPENTÍN GROOVE PULLEY	INTERNO INTERNAL	V6 Et V8 (MANDO)



REF	OEM			REG.	
REC863077T	863077T 86307AR01	12V 70A	6 (50 mm) SERPENTÍN GROOVE PULLEY	INTERNO INTERNAL	4.3L, 6.2L Et 5.7L (1995+) 4.5 MPI 8.1 Et 4.2L



TRIM

CONVERTIDOR DE 3 A 2 CABLES

3 TO 2 WIRE WIRED CONVERTER

REF
REC84-819514T26



SOPORTE

BRACKET

REF	OEM
REC42419A1	862548A1 42419A1



## SOLENOIDES , RELÉS Y FUSIBLES

## SOLENOID, RELAY & FUSES

### SOLENOIDE TRIM

### TRIM SOLENOID

REF	OEM	⚡
REC89-96158T	89-96158T 89-96158	12V
REC852565	89-853654A1 89-68258A4	



REC852565



REC89-96158T

### SOLENOIDE ARRANQUE

### STARTER SOLENOID

REF	OEM	⚡
REC89-96054T	89-96054T 89-96054 89-91975	12V
REC3853839	87-76416A1	



REC3853839



REC89-96054T

### SOLENOIDE DELCO REMY

### DELCO REMY SOLENOID

REF	OEM	⚡
REC13037	13037 8733261	9.5 cm
REC3853869	89-853654A1 89-18080	7.5 cm
REC3859054	89-99253 809463A1	12V



REC13037  
REC3853869



REC3859054

### RELÉ PARA ACELERADOR Y EJE

### RELAY FOR THROTTLE AND SHIFT

REF	OEM	🔧
REC882751A04	882751A04	496 MAG (BASE & H.O.) 8.1L INBOARD (BASE & H.O.) 8.1L TOWSPORT

Relay para cable mecánico  
Relay for mechanical wire



REF	OEM	🔧
REC3854138	821382, 828151/A1, 879312T67/76, 882751/A1/A2 8M0207773;	8.2L INBOARD (BASE & H.O.) EC 8.2L MAG V6 & V8

Relay para cable digital y mecánico  
Relay for digital & mechanical cable



### RELÉ PARA ALARMA Y VARIOS



### RELAY FOR ALARM & OTHERS

REF	OEM	🔧
REC882751A04	821509 821509T01	CMD 2.8 EI, ES (165) CMD 4.2 EI, ES, MI, MS (200, 230, 250, 300) D2.8L/165 D-TRONIC D3.0L, D3.6L, D4.2L/(200, 220, 250, 300)



RELÉ

RELAY

REF	OEM		
REC876037	8M0057697 8M0032176	4.5L Et 6.2L MPI	40/30 A



INTERRUPTORES TRIM

POWER TRIM SWITCH ASSY

REF	OEM	
REC87-18286A43	87-18286A43	
REC87-858679T2	87-858679T2	12V
REC87-859032T02	87-859032T02	



REC87-18286A43



REC87-859032T02



REC87-858679T2

INTERRUPTORES DE PARO

IGNITION KILL SWITCH

REF	OEM	
REC87-91941A8	87-91941A8	12V



REF	OEM
REC8M0092849	8M0092489



REF	OEM
REC87-19674A1	87-19674A1



REF	OEM	
REC19674A07	19674A07	5 FT



REF	OEM	
REC87-133982	87-133982	4000 Gen II Commander 3000 classic, DTS series



ALARMA

ALARM ASSY

REF	OEM
REC8M0144930	8M0144930

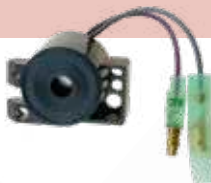

LLAVE DE ARRANQUE

IGNITION SWITCH

REF	OEM
REC893353A03	893353A03



# SISTEMA ENCENDIDO

# IGNITON SYSTEM

## BOBINAS

## COILS

### BOBINA DE ENCENDIDO

### IGNITION COIL

REF	OEM	
REC300-8M0044991	300-8M0044991 8M0029482	4.5L MPI (3 UN.) 6.2L MPI (4 UN.)

DOBLE SALIDA  
TWIN OUT





REF	OEM	
REC806673T1	806673T1 806673T	V8 (5.0 Et 5.7L)



REF	OEM	
REC3854002	898253T27 817378 817378T	4 CIL. (V6 Et V8)





REF	OEM	
REC3861267	392-881732	Motores 496 Magnum 8.1 Inboard



REF	OEM	
REC3859078	392-889925	8.1L Et 496 Mag (OM315053 +)



REF	OEM	
REC3861985	392-863704T 8M0054588	2001+ 4.3, 5.0, 5.7 Et 6.2L EMC OM300000+



### ENCENDIDO ELECTRÓNICO

### ELECTRONIC IGNITION

NO USA RESISTENCIA EXTERNA  
HEI  
Sistema de encendido Thunderbolt

USE WITHOUT EXTERNAL RESISTOR  
HEI  
Thunderbolt ignition system

REF	OEM
REC300-00879	392-805570A2 392-7803A4



USA RESISTENCIA EXTERNA  
HEI  
DELCO 1115202

USE WITH EXTERNAL RESISTOR  
HEI  
DELCO 1115202

REF	OEM
REC1463-9382	898253T24 392-806529A1 32193A2 38547

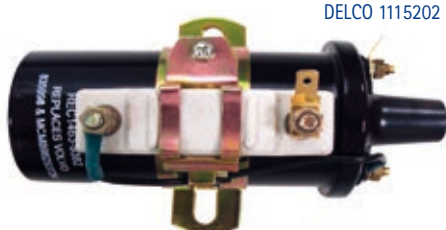

## MÓDULOS IGNICIÓN

## IGNITION MODULES

REF	OEM		BOBINA COIL
REC3858984	GM10482803	4.3, 5.0, 5.7 Et 6.2L MPI ECM555 (2001+) OM300000+	REC3861985



REF	OEM	
REC3854001	811639T	V4, V6, V8 Delco Voyager

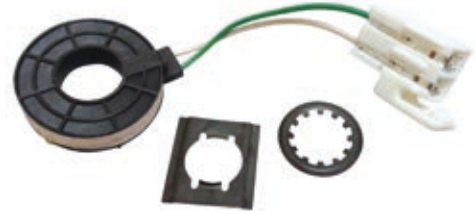

REF	OEM	
REC3854003	811637T 811637001 81637002 811637 850487 804412 802464	4L, V6 Et V8 Delco Voyager



## CABLES

## WIRES

### JUEGOS DE CABLES, ALTO RENDIMIENTO

### HD SPARK PLUG WIRE SET

Núcleo del cable de Kevlar de 8 mm antimagnético. Funda de silicona amarilla. Terminales bujías con muelle de acero inox. Terminal del distribuidor de cobre. Terminales bobina. Silicona resistente a altas temperaturas. Garantía de 5 años.

Antimagnetic Kevlar core. Yellow silicone boot & jacket. SS snaplock. Brass distributor terminal. Coil terminals. High resistant silicone. 5 year warranty.

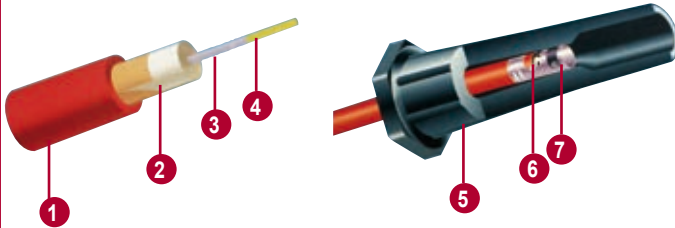

- |   |                                     |                          |
|---|-------------------------------------|--------------------------|
| 1 | Camisa de silicona de 8 mm          | 8 mm silicone jacket     |
| 2 | Látex resistente altas temperaturas | Heat resistant latex     |
| 3 | Acero inox                          | Stainless Steel          |
| 4 | Núcleo de Kevlar                    | Kevlar core              |
| 5 | Capuchón de silicona                | Silicone jacket          |
| 6 | Trenzado especial fibra de vidrio   | Fiberglass braiding      |
| 7 | Terminal de acero inox              | Stainless Steel terminal |

	ARRANQUE IGNITION				
	CYL	CONVEN.	ELECT.	REF	OEM
110/120/2.5L 140/3.0L	4	✓		REC15-401	84-813720A5
120/2.5L 140/3.0L 3.0LX	4		✓	REC15-405	84-813720A13
165-180 LX/470- 485 190 (3.7L)	4	✓		REC15-402	84-813720A5
175/185 (228, 262) 4.3L (GENI)	6		✓	REC15-601	84-813720A11
185 (229)	6	✓		REC15-604	84-813720A7 84-816761Q7
180 (GM)	8	✓		REC15-801	84-813720A8 84-813720A10 84-813720A4
200/5.0L (GM)	8		✓	REC15-804	84-818781A4 84-8167681A17 84-813720A3
4.3L 2002 + MPI	6		✓	REC15-606	84-813720A8
215-225S 223FORD 225-228GM	8	✓		REC15-801	84-813720A10 84-813720A4
228-230/5.0L LX (GM)	8		✓	REC15-804	84-816761A4 84-816878A17 84-813720A3
255 (FORD) 250-225-225-280(GM)	8	✓		REC15-801	84-813720A8 84-813720A10
5.0L GENE+ 2002+ MPI	8		✓	REC15-815	84-816608A1 84-813720A2 84-816781A4 84-816761A17 84-813720A3
350 (5.7L) MAG., SKI	8		✓	REC15-804	84-816761A17 84-813720A3
5.7L GENE+ 2002+ MPI	8		✓	REC15-815	84-816608A1

	ARRANQUE IGNITION				
	CYL	CONVEN.	ELECT.	REF	OEM
270/280/350 (GM)	8	✓		REC15-801	84-813720A8 84-813720A10 84-816761A2
300MR/TRS (GM)	8		✓	REC15-804	84-816781A15 84-816761A6 84-816761A15 84-813720A4
260/320/325 /330/340 (GM)	8		✓	REC15-804	84-816781A4 84-816761A17 84-813720A3
370/380/400/ 440/460 TRS	8	✓		REC15-801	84-813720A8 84-813720A10 84-816761A2
420/425/486 /525/575	8		✓	REC15-804	84-816781A15 84-816761A8 84-816761A2
454/500/502 MAG BRAVO	8		✓	REC15-804	84-816781A15 84-816761A8 84-816761A15 84-813720A8
888 (FORD) 898,198 (GM)	8	✓		REC15-801	84-813720A10 84-816761A2 84-816781A15
888 (GM) 5.7 BRAVO	8		✓	REC15-804	84-816761A8 84-816761A15 84-813720A9 84-813720A10
5.7 SKI	8	✓		REC15-801	84-816761A2 84-816781A15 84-816761A8
7.4L BRAVO	8		✓	REC15-804	84-816761A15 84-816761A8

	ARRANQUE IGNITION				OEM
	CYL	CONVEN.	ELECT.	REF	
7.4L 8.2L CON HURTH	8		✓	REC15-804	84-816761A2 84-816781A15 84-816761A8 84-816761A15 84-816761A2
300 MR/TRS (GM)	8		✓	REC15-804	84-816781A15 84-816761A6 84-816761A15 84-816761A2
330-340 (GM)	8		✓	REC15-804	84-816781A15 84-816761A6 84-816761A15 84-816761A2
454 MAG BRAVO 420/425/465 /525/575	8		✓	REC15-804	84-816781A15 84-816761A6 84-816761A15 84-816761A2
898 (GM) 5.7 BRAVO	8		✓	REC15-804	84-816781A15 84-816761A6 84-816761A15

	ARRANQUE IGNITION				OEM
	CYL	CONVEN.	ELECT.	REF	
500/502 BRAVO	8		✓	REC15-804	84-816761A2 84-816781A15 84-816761A6 84-816761A15 84-816761A2
7.4L BRAVO 7.4L-8.2L CON HURTH	8		✓	REC15-804	84-816781A15 84-816761A6 84-816761A15 84-816761A2
7.4L BRAVO 7.4L-8.2L CON HURTH	8		✓	REC15-804	84-816781A15 84-816761A6 84-816761A15 84-816761A2
6.2L MPI MIE	8		✓	REC15-813	84-863656A1 881698
8.1L 496			✓	REC15-808	8M0117678

### CABLES DE BOBINA

### COIL CABLES

REF	OEM	
REC15-103	813715A1 84-813715A1	9"



### DISTRIBUIDOR

### DISTRIBUTOR

#### TAPA DISTRIBUIDOR

#### DISTRIBUTOR CAPS

REF	OEM		ROTOR ROTOR
REC392-9766	392-9766 392-9766Q1 392-9766T FI6900185	 Prestolite V8	

Con tornillo  
With screw



REF	OEM		ROTOR ROTOR
REC3854331	850484T2 850484T 850484	 Delco V6 E. elect.	REC3854311



REF	OEM		ROTOR ROTOR
REC3854548	808483T3 808483 804483T 804418	 Delco V8 E. elect.	REC3854549



REF	OEM		ROTOR ROTOR
REC3854260	811635T3	 Delco 4 cil 3.0LX	REC3854261





REF	OEM		ROTOR ROTOR
REC815407A2	815407A2 13753A2 815407Q02	 Merc. V6	





REF	OEM		ROTOR ROTOR
REC393-9459Q1	393-9459Q1 393-3230 393-4988T 393-4988T2	 Delco 4 Cil	





REF	OEM	
REC805759001	805759001	Merc. V8
	805759A2/1	
	805759A5	
	805759T2/1	
	16457A4	
	805759T2	
	43557A1	
43557		





REF	OEM		ROTOR ROTOR
REC898253T23	888731	4.3L Vortec V6 MPI	REC898253013
	898253T23		



REF	OEM		ROTOR ROTOR
REC898253T22	884792	Vortec V8 MPI Modernos   Late	REC898253013
	898253T22		



REF	OEM	
REC12532	F16900041	MALLORY V8
	F16900100	
	F16900165	





ROTORES

ROTORS

REF	OEM	
REC898253013	898253013	Vortec V6 & V8 MPI
	884790	
	8M6001222	



REF	OEM	
REC3854311	850485	Delco V6
	8504851	
	898253012	
	8M0062084 804424	



REF	OEM	
REC3854549	8M6001253	Delco V8 E. eléc.
	808484	
	8084841	
	898253010	



REF	OEM	
REC3854261	811636	Delco 4 cil. 3.0LX
	8M6001254	
	8116361	
	898253011	



CONDENSADOR

CONDENSER

REF	OEM
REC0580256	802350



REF	OEM
REC0581419	802357





REF	OEM	
REC64851	81-64851	Autolite
	58034	





TRIGGERS  
(ROTOR + SENSOR)

TRIGGERS  
(ROTOR + SENSOR WHEEL)

REF	OEM	
REC13524A6	13524A6	Merc. V6
	13524Q06	
	13524A4	
	19405A4	
	90576A4	



REF	OEM	
REC13524A1	13524A1	Merc. V8
	13524T1	
	13524A5	





## DISTRIBUIDOR ELECTRÓNICO



## ELECTRONIC DISTRIBUTOR

REF	OEM		
REC805185A3	805185A3	Vortec V6 4.3l MPI (20A V6. HEI Modernos   Late )	REC15-604





REF	OEM		
REC807964A1	807964A1 907964A1	V6 (EFI - TBI)	REC15-601

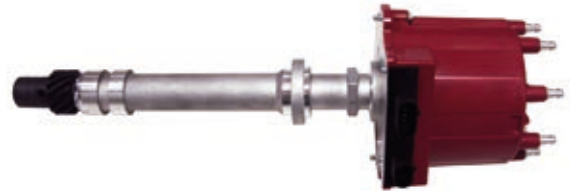

REF	OEM			
REC805222A1	805222A1	V8 (EFI - TBI - MPI)	384 / 409	REC15-804
262-454 et 452				





REF	OEM		
REC817377	817377 817377T	181 RX (LX - MPI) Delco est ignition	REC15-405





## DISTRIBUIDOR

## DISTRIBUTOR

REF	OEM		
REC40005334	888751A03 88751A02 888751A1	Vortec V6 4.3l MPI (2002+) (OM300000+)	REC15-606



REF	OEM		
REC2162232	884794A02 879150A87 884794A1	Vortec V8 2001+ 5.0L, 5.7L, 6.2L MPI (OM300000 +)	REC15-815



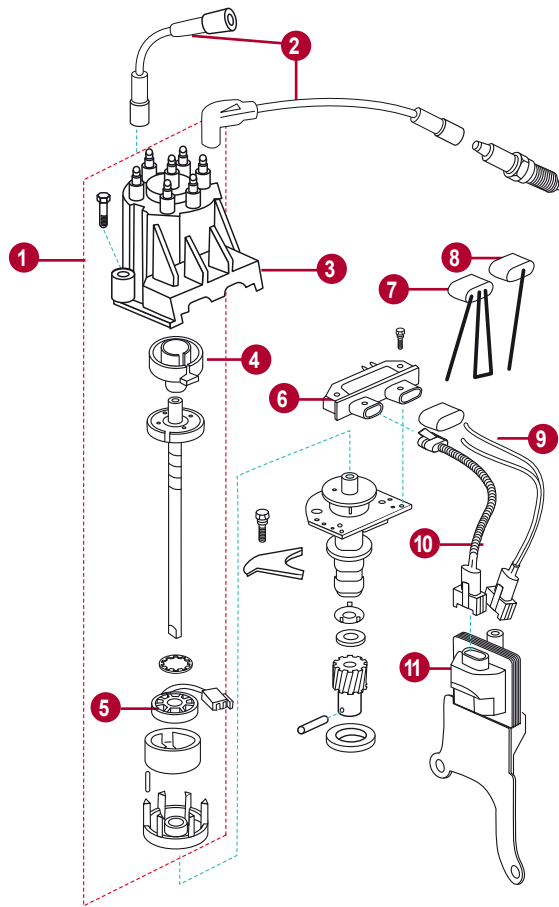

	REF	OEM		
	REC817377	817377	DISTRIBUIDOR 4 CYL	DISTRIBUTOR 4 CYL
1	REC807964A1	807964A1	DISTRIBUIDOR 6 CYL	DISTRIBUTOR 6 CYL
	REC805222A1	805222A1	DISTRIBUIDOR 8 CYL	DISTRIBUTOR 8 CYL
	REC15-405	84-816761Q13	KIT CABLE ARRANQUE: 3.0L	IGNITION WIRE SET: 3.0L
2	REC15-601	84-816761Q16	KIT CABLE ARRANQUE: V6	IGNITION WIRE SET: V6
	REC15-804	84-816761Q17	KIT CABLE ARRANQUE: V8	IGNITION WIRE SET: V8
	REC3854260	3854260	TAPA 4 CYL	CAP 4 CYL
3	REC3854331	3854331	TAPA 6 CYL	CAP 6 CYL
	REC3854548	3854548	TAPA 8 CYL	CAP 8 CYL
	REC3854311	850485	ROTOR V6	ROTOR V6
4	REC3854549	8M6001253	ROTOR V8	ROTOR: V8
	REC3854261	8M6001254	ROTOR 4 CYL	ROTOR 4 CUL
5	REC3854001	811639T	MÓDULO IMPULSOS	MODULE
6	REC3854003	811637001	MÓDULO DISTRIBUIDOR	MODULE: DISTRIBUTOR
7	REC91-888863	91-888863	HERRAMIENTA DISTRIBUIDOR	TOOL: TIMING
8	REC294005		CABLE: INTERRUPTOR	WIRE: SHIFT INTERRUPTER
9	REC500442		CABLE: BOBINA	WIRE LEAD: COIL HARNESS
10	REC84-817376T01	84-817376T01	CABLE: DISTRIBUIDOR - BOBINA	WIRE LEAD: DISTRIBUTOR - COIL
11	REC3854002	898253T27	BOBINA ARRANQUE	COIL: IGNITION

## MPI V6 & V8

	REF	OEM		
1	REC3861985	392-8M0054588	BOBINA ENCENDIDO	IGNITION COIL
2	REC3863130	898141	SENSOR POSICIÓN ÁRBOL DE LEVAS	DISTRIBUTOR PICK-UP
3	REC40005334	888751A03	DISTRIBUIDOR V6	DISTRIBUIDOR V6
	REC21622232	879150A87	DISTRIBUIDOR V8	DISTRIBUIDOR V8
4	REC898253013	8M6001222	ROTOR	ROTOR
5	REC898253T23	898253T23	TAPA V6	CAP V6
	REC898253T22	898253T22	TAPA V8	CAP V8
	REC15-606	84-863656A2	KIT CABLES V6	WIRES KIT V6
6	REC15-815	84-816608A1	KIT CABLES V8 (5.0L, 5.7L)	WIRES KIT V8 (5.0L, 5.7L)
	REC15-813	84-863656A1	KIT CABLES V8 (6.2L)	WIRES KIT V8 (6.2L)

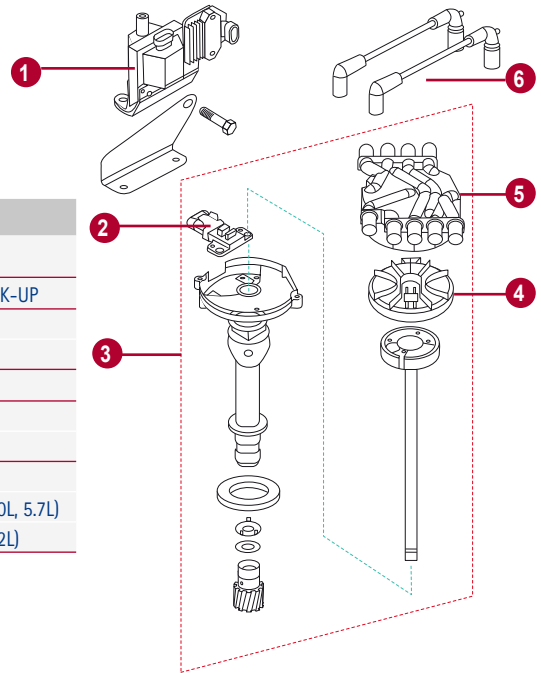

## THUNDERBOLT IV & V

	REF	OEM		
	REC805185A3	805185A37	DISTRIBUIDOR V6 CON TERMINAL	DISTRIBUIDOR ASSY. V6 W/BULLET
1	REC815407A2	815407Q02	TAPA DISTRIBUIDOR V6	DISTRIBUIDOR CAP V6
	REC805759Q01	805759Q01	TAPA DISTRIBUIDOR V8	DISTRIBUIDOR CAP V8
2	REC27-805760	27-805760	JUNTA	GASKET
3	REC27-344861	27-34486-3	JUNTA	GASKET
4	REC87-892150Q02	87-892150Q02	MÓDULO DISTRIBUIDOR	SENSOR ASSEMBLY
5	REC13524A6	13524Q06	ROTOR V6	ROTOR ASSEMBLY V6
	REC13524A1	13524T1	ROTOR V8	ROTOR ASSEMBLY V8
6	REC15-601	84-816761Q16	KIT CABLES BUJÍAS V6	WIRES KIT V6
	REC15-804	84-816761Q17	KIT CABLES BUJÍAS V8	WIRES KIT V8
7	REC300-00879	392-805570A2	BOBINA	COIL

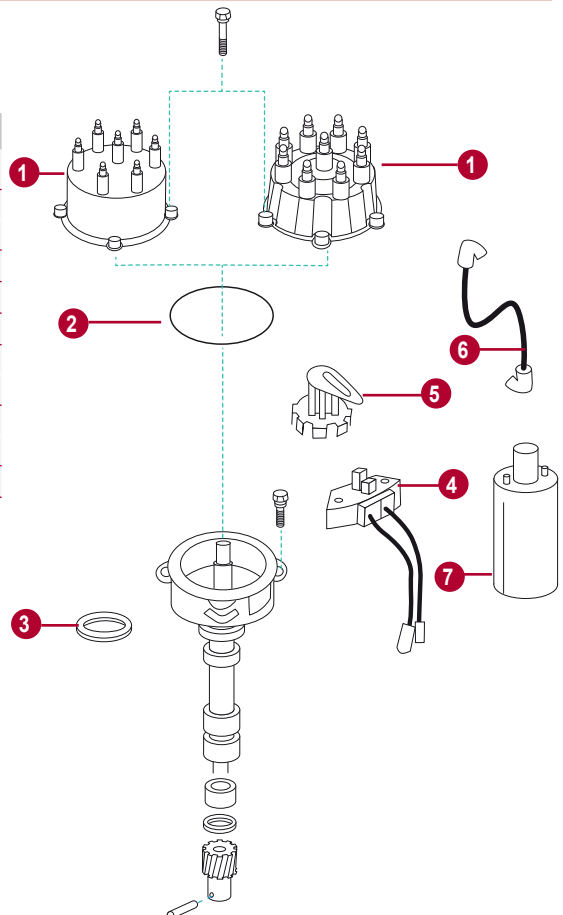

# SISTEMA DE GOBIERNO

# STEERING SYSTEM

## MANDOS DE CONTROL

## ENGINE CONTROLS



### DTS

REF	OEM	TRIM	STOP
REC892984A02	892984A02	✓	✓





### MANDO LATERAL PULL TO OPEN

### SIDE CONTROL PULL TO OPEN

REF	OEM	TRIM		STOP		
REC8M0030550	8M0030550					
REC8M0011213	8M0011213	✓	3 MOLEX	✓	4 FT	GEN II T/S cables.
REC883710A02	883710A02					





REF	OEM	TRIM		
REC8M0100483	8M0100483	✓	4000 series	14
REC8M0100485	8M0100485			14

**MANDO PARA CONSOLA DTS (ERC)**

**CONSOLE CONTROL DTS (ERC)**

REF	OEM	TRIM	STOP
REC8M0079291	8M0079291	✓	✓





**INTERRUPTORES Y CABLES**

**SWITCHES & CABLES**

**EXTENSIÓN DE ARNÉS**

**HARNESS EXTENSION**

REF	OEM		
REC892451T06	892451T06	14	6 ft
REC892451T10	892451T10	14	10 ft
REC892451T20	892451T20	14	20 ft



ARNÉS

HARNESS

REF	OEM	
REC84-866337T01	84-866337T01	1ft
REC84-892990T01	84-892990T01	
REC893378A02	893378A02	
REC896377A01	896377A01	
REC84-8M0055044	84-8M0055044	TACHOMETER



REC84-866337T01



REC84-892990T01



REC893378A02





REC896377A01



REC84-8M0055044

ADAPTADOR DE ARNÉS

HARNESS ADAPTOR

REF	OEM		
REC84-896539T01	84-896539T01	1 FT	9 M --> 14 F
REC84-896540T01	84-896540T01	3 FT	14 M --> 8 M
REC84-896542T05	84-896542T05 896542T05	5 FT	14 M --> 8 M
REC892984K32	892984K32		
REC896542T01	896542T01	1 FT	14 M --> 8 F
REC896542T03	896542T03	3 FT	14 M --> 8 M
REC896542T08	896542T08	8 FT	14 M --> 8 F



REC84-896540T01



REC84-896542T05



REC892984K32



REC896542T01



REC84-896539T01



REC896542T03



REC896542T08

# SISTEMA DE REFRIGERACIÓN

# COOLING SYSTEM

## TERMOSTATO

## THERMOSTAT

### CUERPOS TERMOSTATO

### THERMOSTAT HOUSING

#### ACERO INOXIDABLE

Cola Bravo. Incluye kit de casquillos para adaptarse a cualquier colector.

#### STAINLESS STEEL

Bravo sterndrive. Includes bushing kit to fit any manifold.

REF	OEM	
REC8M0061381	861006A1 8M0061381 860256A4	GM V6 & V8 (305, 350, 357, 383) 4.3, 5.0, 5.7, 6.2L 7.4 & 8.2L (1998+)



### CASQUILLO TERMOSTATO

### THERMOSTAT SLEEVE

REF	OEM	
REC23-806922	23-806922	Para la mayoría de 3.0L, V6, V8 Fits most 3.0L, V6, V8



### MÓDULO DISTRIBUCIÓN DE AGUA

### WATER DISTRIBUTION MODULE

REF	OEM	
RM863631T1	863631T1	GM 4.3, 5.0, 5.7 & 6.2L (MPI)

Drenaje manual  
Manual drain



REF	OEM	
RM863444T1	863444T1	GM 4.3, 5.0, 5.7 & 6.2L (MPI)

Varilla accionada  
Rod actuated



REF	OEM	
REC863802T2	863802T2	V6 & V8 AIR ACTUATED DRAIN



### CONECTOR RÁPIDO

### FITTING

REF	OEM	
REC22-862225	22-862225	4 CYL INLINE V6 & V8



JUNTAS TERMOSTATO

THERMOSTATO GASKETS

REF	OEM	CASQUILLO SLEEVE
REC25-30224	25-30224	REC23-806922
REC27-47510Q	27-47510Q	
REC25-8071341	25-8071341 807134	



REC25-30224



REC27-47510Q



REC25-8071341

CUERPO TERMOSTATO --> CULATA

THERM. HOUSING --> CYLINDER HEAD

REF	OEM	
REC27-8146801	27-8146801	4 & 6 cyl inline



JUNTA TAPA --> CUERPO TERM.

COVER --> THERMOSTAT HOUSING

REF	OEM
REC27-33179Q02	27-33179Q02



BY-PASS --> TERMOSTATO

BY-PASS --> THERMOSTAT HOUSING

REF	OEM	
REC27-41812Q	27-41812Q 27-41812	GM V6 / V8 SMALL BLOCK
REC27-48818Q01	27-48818Q01	GM V8, SMALL & BIG BLOCK
REC27-475901	27-47590-1	4 & 6 cyl inline



REC27-41812Q



REC27-48818Q01



REC27-475901

CUERPO TERM. --> COL. ADMISIÓN

THERM. HOUSING --> INTAKE MANIFOLD

REF	OEM	
REC27-53045Q01	27-53045Q01 53051	GM V6 & V8
REC27-33918	27-8M2021920	GM 4 & 6 cyl inline
REC27-89656-1	27-89656-1	MCM 470 3,7 L (1976-82)



REC27-53045Q01



REC27-33918

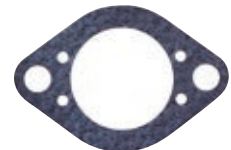

REC27-89656-1

DEPOSITO --> CUERPO TERM.

TANK --> THERMOSTAT HOUSING

REF	OEM	
REC27-74830	27-74830	MCM 470 3.7L (1976-82)



TERMOSTATO

THERMOSTATO

REF	OEM	
REC8M0093561	8M0093561 879194215 879194233 879194231 896332148	CMD 2,8 / 4.2



REF	OEM	
REC8M0093480	8M0093480 8M0067292 8M0066646	TDI 3.0L



KITS TERMOSTATO

THERMOSTATO KIT

REF	OEM		°C
REC59078Q3	59078Q3	4 & 6 CYL INLINE	60°



REF	OEM		°C
REC8M0091470	807252T2 8M0091470	GM V6 & V8, 181° Modelos modernos Late models	70°



REF	OEM		°C
REC8M0089715	807252T1 8M0089715	GM V6 & V8, Ford V8 4.5L MPI (RAW WATER) 6.2L MPI (RAW WATER)	60°



REF	OEM		°C
REC807252Q4	807252Q4 807252T4	GM V6 & V8 4.5L MPI (RAW WATER) 6.2L MPI (RAW WATER)	60°



REF	OEM		°C
REC807252Q5	807252Q5	GM V6 & V8° Modelos modernos Late models	70°



REF	OEM		°C
REC864493	864493	4.3L CARB ALPHA / BRAVO 4.3L MPI ALPHA / BRAVO 4.5L MPI (FRESH WATER) 350 MAG MPI ALPHA / BRAVO 357 HRZ 377 MAG MPI 5.0L MPI ALPHA / BRAVO 5.7L MPI 6.2L MPI	80°



REF	OEM		°C
REC807252Q3	807252Q3 807252T3 807252T6	MCM FORD	140



# ENFRIADOR DE ACEITE

# OIL COOLER

Para saber cual es la ref.que comprende a su motor, informar del modelo de motor y n° de serie

To know which is the model you need, please inform the model and serial number of the engine.

## KITS ENFRIADOR DE ACEITE

## OIL COOLER KITS

1

REF	OEM
REC895207	35-895207 879172151 895207



2

REF	OEM	Icon
REC879194185	879194185	CMDQSD 2.8 Et 4.2

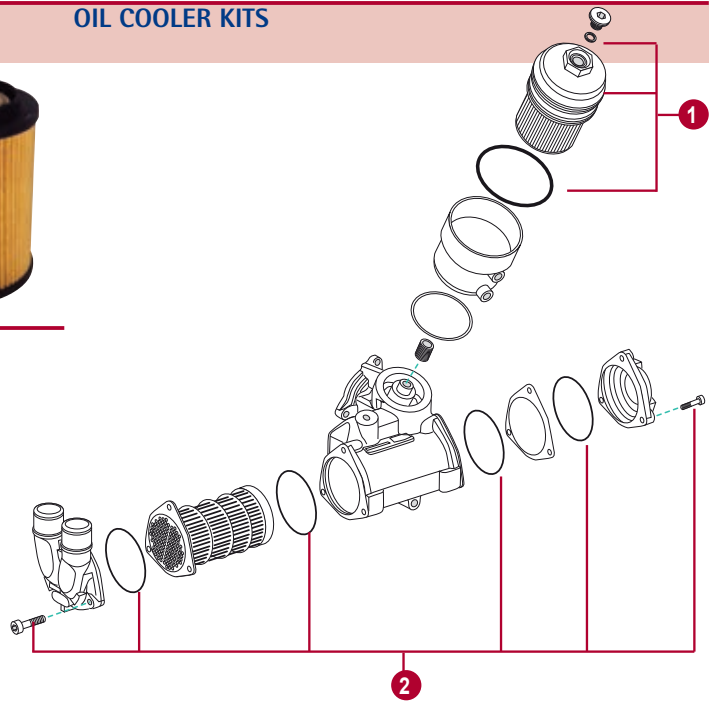

3

REF	OEM	Icon
REC32077	25-896332077	CMQSD 2.0, 2.0EI/ES

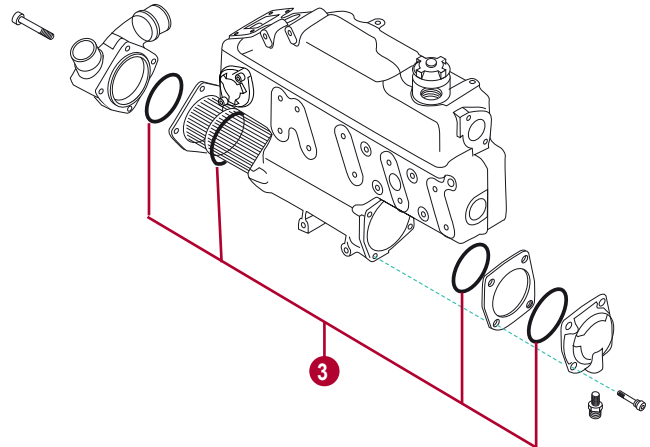

## KITS BOTELLAS DE ACEITE

## RESERVOIR ASSY KITS

REF

OEM

RM806193A48	806193A48
	806193A38
	806193A20
	19742A1 19742A3



REF

OEM

REC22-861150T02	22-861150T02
	22-861150A1
	22-861150A2



REF

OEM

RM22-861163	22-861163
-------------	-----------



# INTERCAMBIADOR DE CALOR

# HEAT EXCHANGER

## KITS INTERCAMBIADOR

## HEAT EXCHANGER KITS

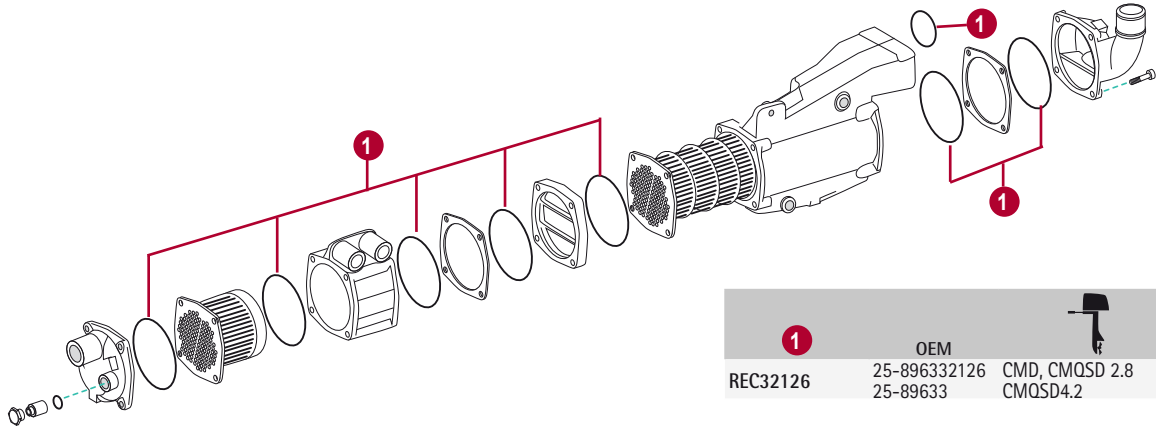

<b>1</b>	OEM		
REC32126	25-896332126 25-89633	CMD, CMQSD 2.8 CMQSD4.2	8

<b>2</b>	OEM	
REC25-8M0084884	8M0084884 25-8M0039163 25-8071341 25-26802	4.5L MPI, 4.3 MPI 350 MPI / 5.0L MPI 383 MAG/MPI 6.2L MPI

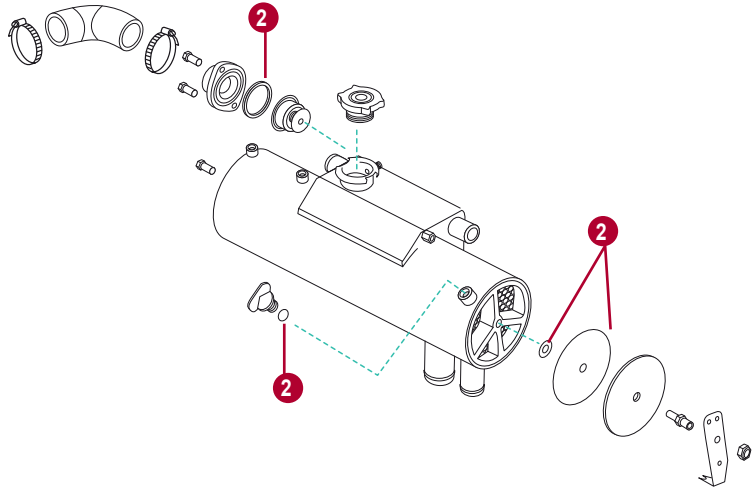

# BOMBAS DE AGUA

# WATER PUMPS

## BOMBAS DE AGUA

## WATER PUMPS

REF	OEM	
REC46-8M0113733	884727 8M0113733	GM 4 Et 6 CYL INLINE





REF	OEM	
REC46-8M0113734	8503991 8M0113734	GM 4 Et 6 CYGM V6 Et V8 SMALL BLOCK





REF	OEM	
REC879194401	46-879194401 8M0094406 8M6005225	V6 (2007+) (Sin bypass   without water bypass hole) MCM MPI (0W658583+) MCM Carb. (1A063240+)



REF	OEM		
RM46-807151A8	46-807151A8 46-72774A69	Mercuriser 454 Magnum 7.4 Et 502 Con acople bomba gasolina. Includes fuel pump adapter.	REC47-59362Q01
GEN V Et VI (1992-99)			



REF	OEM			PORTS
REC8M0155633	8M0155633 897345016 8M0129714	CUMMINS 4.2QSD (270,320,350) 3.0L VM V6 IB/SD (150, 230, 270)	REC15000K	39.75 mm
REC8M0148530	8M0148530 854179001 879312023 8M0148530	MERCURISER CUMMINS MARINE CMD 2.8 EI, ES (170/200) CMD QSD 2.8 EI, ES (170/210/220/230) CMD QSD 2.0 EI,ES (115/130/150)	REC10615K	40.5 mm





**BOMBAS DE AGUA  
BRONCE CON TORNILLERIA DE INOX**

**WATER PUMPS  
BRASS WITH STAINLESS STEEL FITTINGS**

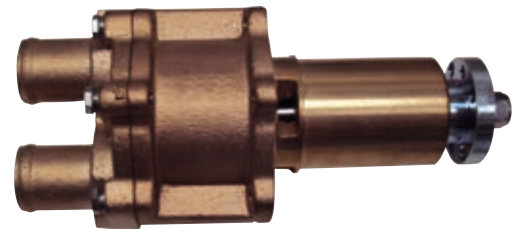
REF	OEM		
REC46-807151A9	46-807151A9	V6 Et V8 con correa serpentín. with MICRO V belt.	REC47-59362Q01



REF	OEM				OEM
REC46-862914T10	46-862914T10	4.3L MPI, 5.0L MPI, 350 MAG MPI Et MX, 8.2L MAG 6.2L MPI (ECM 555)	REC47-862232A2	REC862351T	862351T



## CHAVETA

## KEY

REF	OEM
REC28-161551	28-161551



## JUNTAS BOMBAS DE AGUA

## WATER PUMPS GASKETS

REF	OEM		BOMBA PUMP
REC27-33956	27-33956	4 Et 6 Cyl.	REC46-8M0113733



REF	OEM		BOMBA PUMP
REC27-34897	27-34897	GM V6 Et V8 (Bloque pequeño   Small block)	REC879194401 REC46-8M0113734



REF	OEM	
REC27-49110	27-49110	V-8 (Bloque grande   big block) 454-502 CHEVY



## TAPAS BOMBAS DE AGUA

## WATER PUMPS COVER

REF	OEM
REC94576	72778 8M0204674 94576



## KITS DE REPARACIÓN BOMBA DE AGUA

## WATER PUMP SERVICE KITS

REF	OEM
REC47-59362T6	47-59362T6 59362T6



DESPIECE BOMBA DE AGUA

WATER PUMP ASSY

	REF	OEM			UN.
1	REC12-20084	12-20084	ARANDELA	WASHER	5
2	REC27-8052151	27-8052151	JUNTA	GASKET	1
3	REC27-94914	27-94914	JUNTA	GASKET	1
4	REC47-59362Q01	47-59362Q01	IMPULSOR	IMPELLER	1
5	REC26-90562	26-90562	RETÉN	OIL SEAL	2
6	REC30-72961	30-72961	COJINETE	BEARING	2
7	REC26-72785	26-72785	RETÉN ACEITE	OIL SEAL	1
8	REC46-807151A14	46-807151A14	CUERPO BOMBA	PUMP HOUSING	1
9	REC25-33465	25-33465	ARANDELA	O-RING	1

BOMBA CON 2 PIEZAS DE PLÁSTICO  
2 PCS. PLASTIC PUMP

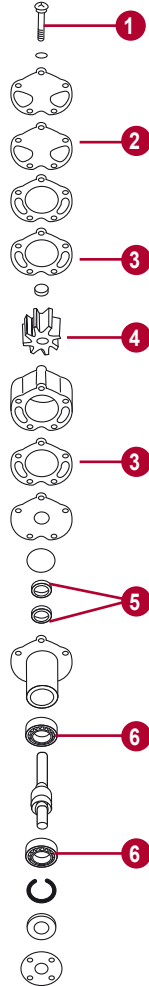

BOMBA CON 1 PIEZAS DE PLÁSTICO  
1 PCS. PLASTIC PUMP

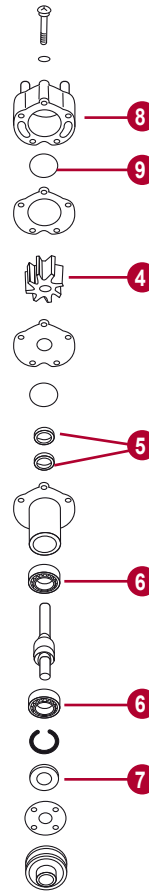

		OEM	REF	A (mm)	B (mm)	C (mm)
1	DIESEL 7.3 L	47-853126 3349198 3916720	REC15000K	16	65	51,2
2	MC-1/R/MR/ALPHA ONE	47-89984T4	REC47-89984T4	22,3	60	33,8
3	ALPHA GENE II	47-43026Q02	REC47-43026Q02	22,4	89	32,5
4	530DTA, 636DTA, D219, D183, D281, D4.2L	47-801332602	REC3841697	14,29	65	50,2
5	BRAVO (inyección   injection)	47-862232A2 47-8M0104229	REC47-862232A2	11,4	66,5	50,6
6	HINO DIESEL	47-809866T 47-831311350	REC47-809866T	14,29	65	68,2
7	D254, D3.6L, D4.2L	47-816814T	REC3593573	14,29	65,2	75,65
8	BRAVO	47-59362Q01	REC47-59362Q01	16,85	66,5	50,6
9	CMD QSD 2.0 & 2.8 SHERWOOD PUMP	47-879312025	REC10615K	15,9	65,2	41,3
10	CMD QSD 2.0 & 2.8 JABSCO PUMP	47-896332063	REC11979-0001	14,29	58,65	36,65
11	CMD QSD 4.2 JABSCO PUMP	47-879194186	REC17937-0001	14,29	65	50,1
12	CMD QSD 4.2 SHERWOOD PUMP	8M0056956	REC15000K	16	65	51,2
13		47-F462065 F462065	REC47-F462065	15	57	14,3

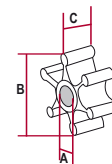

ALPHA ONE GEN II

REF	OEM
REC47-43026Q06	47-43026Q06



OEM		
47-43026Q2	IMPULSOR	IMPELLER
8172761	PLACA	WEAR PLATE
27-8172771	JUNTA	GASKET
27-430331	JUNTA	GASKET
12-191833	JUNTA	GASKET
28-8M0032833	CHAVETA	KEY
26-816575A2	RETÉN	FACE SEAL
816597A1	ACOPLAMIENTO	COUPLIN

REF	OEM	
RECMC00004	47-89984Q5	(1991+)



OEM		
8172761	PLACA	WEAR PLATE
27-430331	JUNTA	GASKET
47-43026Q02	IMPULSOR	IMPELLER
807929A1	RETÉN	PUMP SEAL CARRIER
27-8172772	JUNTA	GASKET

REF	OEM		OEM		
REC817275Q05	817275Q05	D469859+	46-96148T1	TAPA BOMBA	WATER PUMP HOUSING
			27-430331	JUNTA	GASKET
			47-43026Q02	IMPULSOR	IMPELLER
			807929A1	RETÉN	SEAL
			27-8172772	JUNTA	GASKET
			8172761	PLACA	WEAR PLATE



**BRAVO I, II, III**

REF	OEM	BOMBA PUMPA	
REC46-807151A14	807151A14	1 p. Plast.	

REF	OEM	
REC98-8M0121940	98-8M0121940	4.5 Et 6.2L



**1 | R | MR | ALPHA ONE**

REF	OEM	
REC46-44292Q03	46-44292Q03	MR1 Alpha one (1984-90)



REF	OEM	
REC12120	46-96148A8	MR / ALPHA I (6225577+)

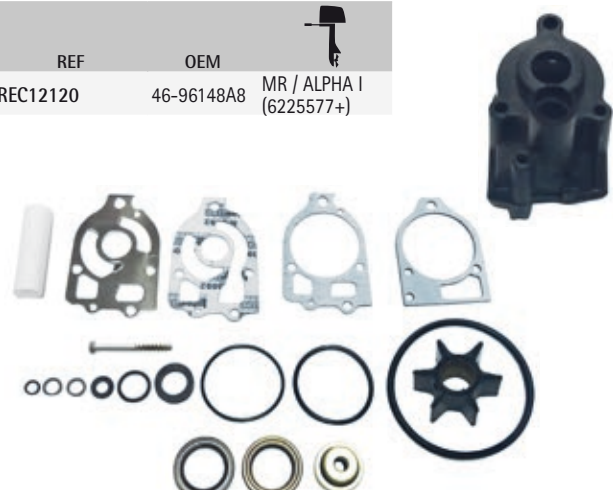

**KITS COMPLETOS**

REF	OEM	
REC47-89984Q5	47-89984Q5	MC-1 Et ALPHA-ONE



**FULL KITS**

OEM		
324351	TAPA BOMBA	PUMP COVER
12-191833	JUNTA	GASKET
23-29804T	TUBO AGUA	WATER TUBE
25-30224Q	ARO	O-RING
25-30271	ARANDELA	WASHER
25-30613	ARO	O-RING
25-33145	ARO	O-RING
25-90011	ARO	O-RING
26-455771	RETÉN	SEAL
27-32438	JUNTA	GASKET
27-426311	JUNTA	GASKET
27-856081	JUNTA	GASKET
27-856091	JUNTA	GASKET
27-856704	JUNTA	GASKET
47-89984T4	IMPULSOR	IMPELLER
26-38970	ACOPLE GOMA	COUPLING
25-38099	ARO	O-RING
25-26722	ARO	O-RING

REF	OEM	
REC46-96148A8	46-60367A1	Parte superior.
	46-96148A8	Upper water pump housing.
	46-96148A5	MC-1 et ALPHA-ONE

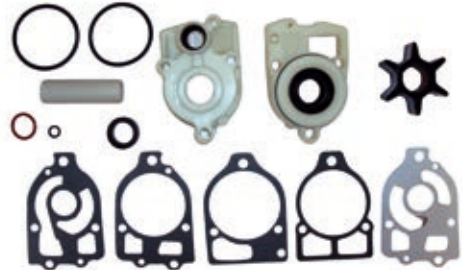

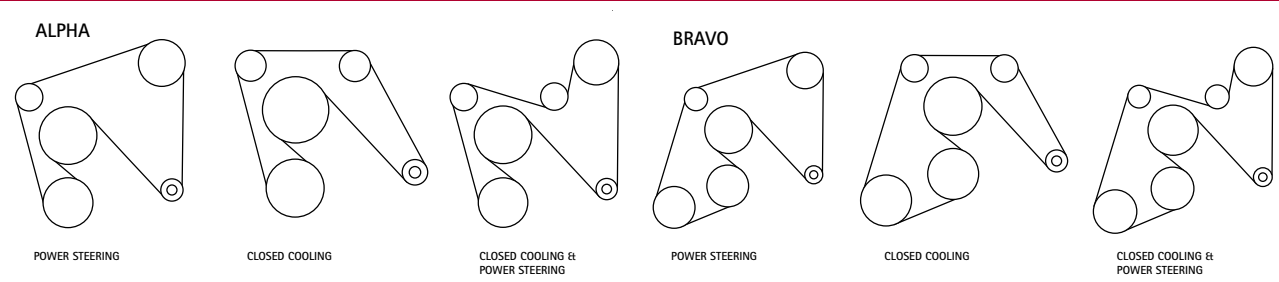

OEM		
324351	TAPA BOMBA	PUMP COVER
12-191833	JUNTA	GASKET
23-29804T	TUBO AGUA	WATER TUBE
25-30224Q	ARO	O-RING
25-30271	ARANDELA	WASHER
25-30613	ARO	O-RING
25-33145	ARO	O-RING
25-90011	ARO	O-RING
26-455771	RETÉN	SEAL
27-32438	JUNTA	GASKET
27-426311	JUNTA	GASKET
27-856081	JUNTA	GASKET
27-856091	JUNTA	GASKET
27-856704	JUNTA	GASKET
48-96148T1	CUERPO BOMBA	PUMP HOUSING
47-89984T4	IMPULSOR	IMPELLER

## CORREAS BELTS



	GUÍA DE CORREAS BOMBA AGUA		V-BELTS GUIDE WATER POMPE	
	SERIE SERIAL	ALTERNADOR ALTERNATOR	DIRECCIÓN POWER STEERING	
CMD 1.7MS 120 I/L4	8810800	RM57-862054Q	RM57-862054Q	
CMD 1.7MI 120 L/L4	88109041	RM57-862054Q	RM57-862054Q	
CMD QSD 2.8 et 4.2			REC57-898101580	

	GUÍA DE CORREAS BOMBA AGUA		V-BELTS GUIDE WATER POMPE		
	AÑO YEAR	SERIE SERIAL	ALTERNADOR ALTERNATOR	DIRECCIÓN POWER STEERING	BOMBA AGUA SALADA SEA WATER PUMP
110	63-66	1537370 - 2044033	REC57-49043A1		
120	64-73	1666601-3770649	REC57-49043A1		
120	74-82	3770650-6229717	REC57-49043A1	REC57-65607Q (37")	
120	74-82	3770650-6229717	REC57-49043A1	REC3852106 (40")	
120(2.5L)	82-89	6229718 - C853255	REC57-49043A1		
120(2.5L)	82-89	6229718 - C853255 W/P/S	REC3852106	REC57-65607Q	
140	68-73	2508261-3770649	REC57-49043A1		
140	74-82	3770650-6229717	REC57-49043A1	REC57-65607Q (37")	
140	74-82	3770650-6229717	REC57-49043A1	REC3852106 (40")	
140/3.0L/3.0LX	1982	6229718	REC57-49043A1		
140/3.0L/3.0LX	1982	6229718+ W/PS	REC3852106	REC57-65607Q	
150	64-66	1666495-2048646	REC57-49043A1		
160	67-69	2048022-2770031	REC57-49043A1		
165	70-73	2770032 - 3774864	REC57-49043A1		
165	74-81	3774865 - 5813433	REC57-49043A1	REC57-65607Q (37")	
165	74-81	3774865 - 5813433	REC57-49043A1	REC3852106 (40")	
165/170/180/190/3.7L	85-89	6916779 - C762299	REC57-49043A1	REC57-49043A1	
470 (170HP)	83-84	6218037 - 6916778	REC57-49043A1	REC57-49043A1	
488	83-84	6170297 - 6916778	REC57-49043A1	REC57-49043A1	
175	1987	0B527955-0B773242	REC57-49043A1	REC57-816295Q	
175/185/4.3L	85-92	A331455 - D714106	REC3858462	REC57-34359	REC966903
3.0L GM 181 I/L4		OW302000+		RM57-862054Q	
3.0 MPI EC		1A072812+		RM57-862054Q	
3.0 TKS Pus		1G404114+		RM57-862054Q	
4.3L	92-96	D714107 - F802999	REC829207		REC57-13457Q
4.3L (2bbi)	88-32	0B773243-0D714106		REC57-816295Q	

	AÑO YEAR	SERIE SERIAL	ALTERNADOR ALTERNATOR	DIRECCIÓN POWER STEERING	BOMBA AGUA SALADA SEA WATER PUMP
4.3L (GenII) (2 bbl)	92-96	OD714107-OF802999		REC57-816295Q	
4.3LX (4bbl)	88-92	OB775130-OD714369		REC57-816295Q	
4.3LX (Gen II)	92-96	OD714370-OF802999		REC57-816295Q	
888	71-77	3108723 - 4887829	REC3858462		
888	71-77	3108723 - 4887829	REC3858462	REC57-13457Q (30")	REC3858462
898 W/O HIGH MT P/S	77-84	4762210 - 6218461	REC829207	REC966900	REC966903
898 W/ HIGH MT P/S	77-84	4762210 - 6218461	REC3858462		REC966903
898/200/5.0L	85-95	6218462 - F600999	REC3858462		REC966903
898/200/5.0L	85-95	6218462 - F600999	REC829207	REC57-34359	REC57-13457Q
200	1969	2453769 - 2712072	REC57-49043A1		
205	85-91	A331455 - D714369	REC3858462	REC57-34359	REC966903
215	70-72	2781153 - 3563181	REC3858462		
215 MIE	70-72	2781153 - 3563181	REC3858462		
225	73-74	3385721 - 4166999	REC3858462	REC57-34359	REC966903
225 MIE	73-74	3385721 - 4166999	REC3858462		
225 MCM/MIE	67-69	2278647 - 2694014	REC829207		
228 W/O HIGH MT P/S	77-82	4765100-6218461	REC829207	REC966900	REC966903
228 W/ HIGH MT P/S	77-82	4765100-6218461	REC3858462		REC966903
228/230/5.0L	83-95	6218462 - F600999	REC3858462		REC966903
228/230/5.0L	83-95	6218462 - F600999	REC829207	REC57-34359	REC57-13457Q
228 MIE	1977	4765100 - 4929030	REC829207		REC966900
228/230/5.0L MIE	78-87	4929030 - B788151	REC3858462		REC966903
228/230/5.0L MIE	78-87	4929030 - B788151	REC829207	REC57-34359	REC57-13457Q
233	75-77	4173000 - 4902304	REC3858462		
233	75-77	4173000 - 4902304	REC3858462	REC57-13457Q	REC966903
233 MIE	75-76	4173000 - 4775784	REC3858462		
250	68-69	2314301 - 2639854	REC829207		
250	1977	4768000 - 4908849	REC3858462	REC966903	REC966903
255 MCM/MIE	73-74	3258728 - 4175499	REC3858462		
255	75-76	4175500 - 4498700	REC829207		
255	1976	4498701-4499060	REC829207		
255	1976	4499061-4767999	REC829207		
255 MIE	75-77	4175500 - 4498700	REC829207		
255 MIE	77-78	4498701 - 4924564	REC829207		REC966903
255/260/5.7L MIE Et Ski	78-86	4924565 - B522505	REC3858462		REC966903
260/5.7L MIE Et Ski	87-93	B522506 - F024999	REC3858462		REC966903
260/5.7L MIE Et Ski	87-93	B522506 - F024999	REC829207		REC57-13457Q
5.7L MIE Et Ski	94-96	F025000 - K040306	REC829207		REC57-13457Q
260 W/HM P/S	78-82	4908850 - 6218461	REC3858462		REC966903
260 W/LM P/S	1978-82	4908850 - 6218461	REC829207		REC966903
260/5.7L	1983-95	6218462 - F600999	REC3858462		REC966903
260/5.7L	1983-95	6218462 - F600999	REC829207	REC57-34359	REC57-13457Q
5.7L/5.7LX	1996	F601000 - K001526	REC829207	REC57-816295Q	REC57-13457Q
350 MAG	1986-95	A635178 - F600999	REC3858462	REC57-34359	REC966903
350 MAG	1986-95	A635178 - F600999	REC829207		REC57-13457Q
350 MAG	1996	F601000 - K001500	REC829207		REC57-13457Q
350 MAG Ski	1991-96	D505450 - K040005	REC829207		REC57-13457Q
Black Scorpion Ski	1996	F800000 - K040000	REC829207		REC57-13457Q
270 MCM/MIE	1969-72	2851074 - 3385720	REC829207		
280	1975	4176250 - 4176468	REC829207		
280	1975-76	4176469 - 4499390	REC829207		
280	1976	4499391 - 4499780	REC829207		
280	1976	4499781 - 4770199	REC829207		
5.7L	1988-96	OB525982-OF600999		REC57-816295Q	
5.7LEFI (2bbl)	1996	OF752400-OK001505		REC57-816295Q	
5.7L Alpha EFI (TBI)	1995	OF355305-OF752389		REC57-816295Q	
5.7L Bravo EFI (TBI)	1995	OF225560-OF752399		REC57-816295Q	
5.7LX Bravo EFI (Gen+)	1996	OF800300-OK001508		REC57-816295Q	
5.7LX EFI (4bbl TBI)	1996	OF752400-OK001505		REC57-816295Q	
320(EFI)	1987-89	A543604 - C622418	REC3858462	REC57-34359	
325 MCM/MIE	1968-74	2278747 - 3780449	REC57-48122Q		
330	1977-81	4623115-6083144	REC57-78200Q1		REC966903
330	1982-87	6083144 - B816540	REC57-78200Q1		REC966903
330	1982-87	6083144 - B816540	REC57-78200Q1	REC966931 (55")	REC57-13457Q
340 (7.4L)	1981-92	5889914 - D715493	REC57-78200Q1		REC966903
340 (7.4L)	1981-92	5889914 - D715493	REC57-78200Q1		REC57-13457Q
350 MIE	1974-75	3780450-4501640	REC57-48122Q		
350 MIE	1976	4501641 - 4623109	REC57-48122Q		REC966903
350 Mag Alpha	1987-95	OB525982-OF600999		REC57-816295Q	
350Mag Alpha (4bbl)	1996	OF601000-OK001526		REC57-816295Q	
350Mag Alpha EFI (Gen+)	1996	OF800300-OK001508		REC57-816295Q	
350Mag Bravo MPI	1995	OF415189-OF601999		REC57-816295Q	
350Mag Bravo MPI (Gen+)	1996	OF602000-OK001500		REC57-816295Q	
7.4L BRAVO	1988-91	B771113 - D603117	REC57-78200Q1	REC966931	REC57-13457Q
7.4L BRAVO	1988-91	B771113 - D603117	REC57-48122Q		REC57-13457Q
7.4L/LX BRAVO	1992-97	D603118 - K999999	REC57-48122Q		REC3852106
7.4LX Bravo (TBI)	1996-97	F820000 - K999999	REC57-48122Q		REC57-13457Q
7.4LX Bravo (MPI)	1996-97	F602010 - K147349	REC57-48122Q		REC3852106
7.4LX Bravo (MPI)	1997	K147350 - K999999	REC57-48122Q		REC57-13457Q

	AÑO YEAR	SERIE SERIAL	ALTERNADOR ALTERNATOR	DIRECCIÓN POWER STEERING	BOMBA AGUA SALADA SEA WATER PUMP
7.4L MIE	1989-92	C391564 - D715493	REC57-78200Q1		REC57-13457Q
7.4L MIE	1989-92	C391564 - D715493	REC57-48122Q		REC57-13457Q
7.4L MIE	1992-97	C391564 - K999999	REC57-48122Q		REC3852106
454 MAG Alpha	1986-88	A631894 +	REC57-78200Q1		
454 MAG Alpha	1986-88	A631894+	REC57-78200Q1	REC966931 (55")	
454 MAG	1988-92	B721206 - D805068	REC57-78200Q1	REC966931	REC57-13457Q
454 MAG	1988-92	B721206 - D805068	REC57-48122Q		REC57-13457Q
454 MAG	1992-97	D805069 - K999999	REC57-48122Q		REC3852106
454 MAG (MPI)	1994-97	F115700 - K147349	REC57-48122Q		REC3852106
454 MAG (MPI)	1997	K147350 - K999999	REC57-48122Q		REC57-13457Q
454 MAG Ski	1995-97	F215800 - K999999	REC57-48122Q		REC3852106
370(TRS)	1978-85	4179554 - 6721527	REC57-48122Q		
370(TRS)	1985-87	6721528 - B714586	REC57-48122Q		
390 MCM/MIE	1969-70	2781129 - 3042731	REC57-48122Q		
400 (TRS)	1980-86	4179554 - B457644	REC57-48122Q		
420/425	1987-92	A398941 - D725499	REC57-48122Q		
420/425	1992	D725500 - D937011	REC57-48122Q		REC3852106
440 (TRS)	1983-86	4179554 - B485220	REC57-48122Q		
450	1995-96	F347100 - F347227	REC57-48122Q		REC3852106
460 (TRS)	1983-86	4179554 - 6181046	REC57-48122Q		
502 MAG	1990-97	C878221 - D824588	REC57-48122Q		REC57-13457Q
502 MAG	1990-97	C824589 - K999999	REC57-48122Q		REC3852106
502 MAG (MPI)	1994-97	D840650 - K147349	REC57-48122Q		REC3852106
502 MAG (MPI)	1997	K147350 - K999999	REC57-48122Q		REC57-13457Q
8.2L MIE	1990-93	C878221 - D857199	REC57-48122Q		REC57-13457Q
8.2L MIE	1993-97	D857200 - K999999	REC57-48122Q		REC3852106
8.2L MPI MIE	1996-97	F819620 - K147349	REC57-48122Q		REC3852106
8.2L MPI MIE	1997	K147350 - K999999	REC57-48122Q		REC57-13457Q



GUÍA DE CORREAS SERPENTIN

MICRO V BELTS GUIDE

	AÑO YEAR	SERIE SERIAL	REF	NOTA FOOTNOTE
4.3L Alpha	1996-99	OF803000-OL618999	REC57-807755Q05	4
4.3L Alpha	1996-99	OF803000-OL618999	REC57-861758Q	2, 6
4.3L Alpha	2000-04	OL619000 +	REC57-865615Q04	3, 6, 7
4.3L Alpha	2000-04	OL619000+	REC57-865615Q08	4, 5, 7
4.3L Alpha	2000-04	OL619000+	REC57-865615Q03	3
4.3L Bravo	1996-99	OF803000-OL618999	REC57-861757Q	2, 6
4.3L Bravo	2000-04	OL619000+	REC57-865615Q08	4, 7
4.3L Bravo	2000-04	OL619000+	REC57-865615Q03	3
4.5 & 6.2L Bravo Raw system			REC57-8M0097728	
4.5 & 6.2L Bravo Fresh system			REC57-8M0088876	
5.0L Bravo	2002-04	OM600000+	REC57-865615Q06	3, 5, 7
5.0L Alpha	1998-99	OL012052-OL618999	REC57-807755Q05	4, 6
5.0L Alpha	1998-99	OL012052-OL618999	REC57-861758Q	2, 6
5.0L Alpha	2000-04	OL619000+	REC57-865615Q06	3, 6, 7
5.0L Alpha	2000-04	OM600000+	REC57-865615Q06	3, 5, 7
5.0L Alpha	2001-04	OL619000+	REC57-865615Q08	4, 5, 7
5.0L Alpha	2001-04	OL619000+	REC57-865615Q03	3
5.0L Bravo	1998-99	OL012052-OL618999	REC57-861757Q	2, 6
5.0L Bravo	2000-04	OL619000+	REC57-865615Q08	4, 7
5.0L Bravo	2000-04	OL619000+	REC57-865615Q03	3
350 Mag, Alpha	1997-04	OK001501-OL618999	REC57-807755Q05	4, 6
350 Mag, Alpha	1997-04	OK001501-OL618999	REC57-861758Q	2, 6
350 Mag, Alpha	2002-04	OM600000+	REC57-865615Q06	3, 5, 7
350 Mag, Alpha	2000-04	OL619000+	REC57-865615Q08	4, 5, 7
350 Mag, Alpha	2000-04	OL619000+	REC57-865615Q03	3

NOTA

- 1 Usar con polea bomba de plástico Ø 4-3/4"
- 2 Usar con polea bomba de metal Ø 4-3/4"
- 3 Para motores con dirección hidráulica
- 4 Para motores sin dirección hidráulica
- 5 Para motores con circuito de refrigeración cerrado
- 6 Para motores con refrigeración standard
- 7 Para motores con alternadores montados en alto
- 8 Intercambiador
- 9 Alternador

	AÑO YEAR	SERIE SERIAL	REF	NOTA FOOTNOTE
350 Mag, Bravo	1997-04	OK001501-OL618999	REC57-861757Q	2, 6
350 Mag, Bravo	2002-04	OM600000+	REC57-865615Q06	3, 5, 7
350 Mag, Bravo	2000-04	OL619000+	REC57-865615Q08	4, 7
350 Mag, Bravo	2000-04	OL619000+	REC57-865615Q03	3
5.7L Alpha	1997-99	OK001501-OL618999	REC57-807755Q05	4, 6
5.7L Alpha	1997-99	OK001501-OL618999	REC57-861758Q	2, 6
5.7L Alpha	2000-04	OL619000+	REC57-865615Q08	3, 6, 7
5.7L Alpha	2000-04	OL619000+	REC57-865615Q03	3
5.7L Alpha	2000-04	OM600000+	REC57-865615Q06	3, 5, 7
5.7L Alpha	2000-04	OL619000+	REC57-865615Q08	3, 6, 7
5.7L Alpha	2000-04	OL619000+	REC57-865615Q03	3
5.7L Bravo	1997-99	OK001501-OL618999	REC57-861757Q	2, 6
5.7L Bravo	2002-04	OM600000+	REC57-865615Q06	3, 5, 7
5.7L Bravo	2000-04	OL619000+	REC57-865615Q08	4, 7
5.7L Bravo	2000-04	OL619000+	REC57-865615Q03	3
377 Scorpion MCM	1999-04	OL416146+	REC57-861757Q	
454 Mag MPI	1998-01	OL010029-OM024999	REC57-865615Q06	2
496 Mag & HO	2000-04	OM025000+	REC57-865615Q01	
502 Mag MPI	1998-01	OL017000-OM024999	REC57-865615Q06	2
7.4L MPI	1998-01	OL010003-OM024330	REC57-865615Q06	2
MX 6.2L MPI	2002-04	OM600000+	REC57-865615Q06	3, 5
MX 6.2L MPI	2000-04	OL680003+	REC57-865615Q08	4, 7
MX 6.2L MPI Horizon	2002-04	OM600000+	REC57-865615Q06	3
MX 6.2L MPI Horizon	2001-04	OM300000+	REC57-865615Q08	4

FOOTNOTE

- 1 Use w/ plastic 4-3/4" Ø p/s pump pulley
- 2 Use with metal 5-3/4" Ø p/s pump pulley
- 3 For engines with power steering
- 4 For engines without power steering
- 5 For engines with closed cooling
- 6 For engines with standard cooling
- 7 Engines with high mounted alternators
- 8 Blower
- 9 Alternator



REF	OEM	LARGO LENGHT	ANCHO WIDHT
REC57-865615Q03	57-865615Q03	270,4 cm	2.06 cm
REC57-865615Q04	57-865615Q04	194,1 cm	
REC57-865615Q06	57-865615Q06	266,7 cm	
REC57-865615Q08	57-865615Q08	253,5 cm	
REC57-807755Q05	57-807755Q05	193,0 cm	
REC57-861757Q	57-861757Q	247,1 cm	

REF	OEM	LARGO LENGHT	ANCHO WIDHT
REC57-861758Q	57-861758Q	219,7 cm	2.06 cm
REC57-865615Q01	57-865615Q01	283,0 cm	
REC57-8M0097728	57-8M0097728	171,3 cm	
	57-8M0074767		
REC57-8M0088876	57-8M0088876	168,7 cm	

**TENSOR CORREA V6 & V8** **V6 & V8 BELT TENSIONER**

	REF	OEM		
1	REC8M0113182	8183812	PIÑON TENSOR	PINION STUD. SS
2	REC865193	865193	CASQUILLO	BUSHING
3	REC864625T	864625T	POLEA	PULLEY (4.25" Ø)
4	REC11-859135	859135	TUERCA	NUT
5	REC8M6500024	865598	POLEA	PULLEY
6	REC865193	865193	CASQUILLO	BUSHING

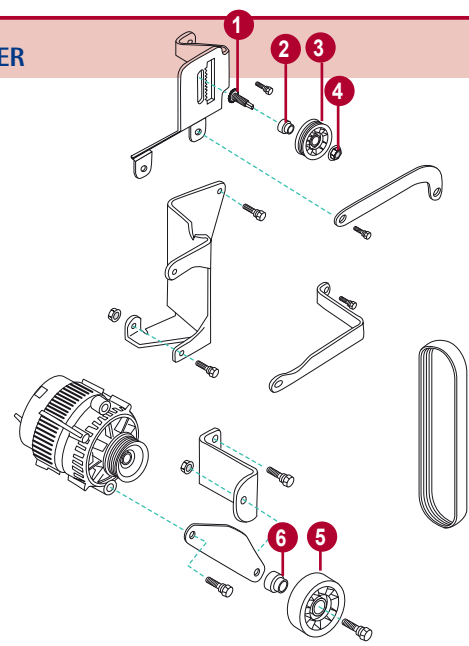

**POLEA BOMBA DE AGUA** **WATER PUMPS PULLEY**

REF	OEM		Ø	BOMBA PUMP	
REC8M0153706	8M0153706 807729T		V6 & V8 (SERPENTIN)	150 mm	REC46-8M0113734



**POLEA PLANA SERPENTÍN** **IDLER PULLEY**

REF	OEM	
REC896332057	896332057	 CMD 2.8 DMQSD 2.8 CMQSD 4.2



**POLEA GUÍA DE CORREA SERPENTÍN** **GUIDE PULLEY**

REF	OEM		Ø	
REC8M6500024	8M6500024		V6 & V8	80,96 mm



**TENSOR CORREA SERPENTÍN** **BELT TENSIONER**

REF	OEM		Ø	
REC8M0111642	8M0111642 898101425		CMQSD 2.8/4.2	
REC807757T	807757T		V6 & V8	3"



**GUÍA DE CORREAS SERPENTIN** **MICRO V BELTS GUIDE**

	REF	OEM	
	CMD QSD 2.0 115/130/150/170	REC57-879172120	57-879172120
	CMD QSD 2.8 170/210/220/230	REC57-879194425	57-879194425
	CMD QSD 4.2 270/320/350	REC57-898101579	57-898101624 57-898101579
	TDI 3.0L V6	REC57-8M0093495	57-8M0093495 8M0067268
			ALT & POWER STEERING



**GUÍA DE CORREAS MOTOR**

**V-BELTS GUIDE**

REF	OEM
REC57-13457Q	57-13457Q
REC966931	57-13458Q
REC3852106	57-32850
	57-69143Q
	57-34359
REC57-34359	57-37619T, Q

REF	OEM
REC3858462	57-45856
	57-49213A1
	57-93658Q
REC829207	57-48120Q1
REC57-48122Q	57-48122Q
REC57-49043A1	57-49043A1
	57-64032Q1

REF	OEM	
REC57-65607Q	57-65607T	940 mm
REC966903	57-74271Q	
REC966900	57-77274	
REC57-78200Q1	57-78200Q1	
REC57-816295Q	57-816295Q	

**MANGUITOS DE MOTOR**

**HOSES**

**BOMBA DE AGUA**

**WATER PUMP**

REF	OEM	
REC32-33189	32-33189	1 3/4" ID 12 3/4"



**TOMA DE AGUA**

**WATER SYSTEM**

REF	OEM	Ø	LONGITUD LENGHT
REC32-4172533	32-4172533	3/4"	13 7/8"
	32-8M0062309		
REC32-32461	32-32461	5/8"	13 7/8"
	32-32461A1		



REF	OEM	
REC8M0062102	32-8M0062102	Bravo Design II



REF	OEM	
REC32-43437	32-43437	Bravo Design I



**BOMBA DE AGUA --> ENFRIADOR DE ACEITE**

**MOLDED SEAWATER PUMP --> OIL COOLER**

REF	OEM
REC32-88795	32-88795



**CUERPO TERMOSTATO --> COLECTOR ESCAPE ESTRIBOR**

**THERMOSTAT HOUSING --> STARBOARD EXHAUST MANIFOLD**

REF	OEM
REC32-871171	32-87117 1
	32-87117



**MANGUITO DE MOTOR**

**HOSE**

REF	OEM
REC32-33220	32-33220
	32-3322070
	32-55483
	32-8M0062614
	3322070 8M0062614



REF	OEM
REC32-808033	32-808033 808033



REF	OEM
REC32-16012	16012 32-16012



REF	OEM
REC32-897181	32-897181 89718 897181





### GUÍA MANGUITOS (EJE - GASOLINA)

### HOSES FUEL GUIDE (SHAFT - FUEL)

MOD	SERIE	TERMOS. --> BOMBA THERMOS. --> PUMP	TERMOS. --> COLECTOR. THERMOS. --> MANIFOLD		ENFRIADOR ACEITE OIL COOLER TERMOSTATO THERMOSTAT
			ESTRIBOR STB	ESCAPE EXHAUST	
198 MIE (2bbl.)	4762210-6218461	REC32-33189			
228 MIE (4bbl.)	4765100-5170008	REC32-33189			
228 MIE (4bbl.)	5170009-5907057	REC32-33189			
230 MIE (4bbl.)	5907058-0B522505	REC32-33189			REC27-68714A6
230/5.0L MIE (4bbl.)	0B522506-0B788151	REC32-33189			REC27-68714A6
225MIE	2278647-2694014			REC32-33189	
250 MIE	2314301-2639854	REC32-33189		REC32-33189	
255 MIE	4175500-5195908	REC32-33189		REC32-33189	
255 MIE	5195909-5907057	REC32-33189			
260 MIE	5900758-0B522505	REC32-33189			REC27-68714A6
260/5.7 MIE	0B522506-0F024999	REC32-33189			REC27-68714A6
5.7L MIE	0F025000+	REC32-33189	REC32-871171	REC32-33189	
5.7L (SKI) MIE	0A338533-0B514626	REC32-33189			
5.7L (COMP. SKI)	0B514627-0F775199	REC32-33189	REC32-871171		
5.7L (COMP. SKI)(2bbl.)	0F775200+	REC32-33189			
350 Mag. (SKI) CARB	0D505450+	REC32-33189	REC32-871171		
350 Mag. (SKI) (9EFI)TBI	0F215561+	REC32-33189			
350 Mag. (SKI) (9EFI)MPI	0F350583+	REC32-33189			
270 MIE	2851074-3077735	REC32-33189			



### GUÍA MANGUITOS (COLA)

### HOSES FUEL GUIDE (STERN DRIVES)

MOD	SERIE	REF	TERMOS. --> COLE. ESTR. THERMOS. --> STB MANIFOLD	ENFR. ACEITE --> BOMBA OIL COOLER --> WATER PUMP	MOD	SERIE	REF	TERMOS. --> COLE. ESTR. THERMOS. --> STB MANIFOLD	ENFR. ACEITE --> BOMBA OIL COOLER --> WATER PUMP
120	3377341-5192048	REC32-8M0071007			260	6218462-0B525981	REC32-33189		REC27-68714A6
120	5192049-6229717	REC32-8M0071007			260	6218462-0B525981	REC32-33189		
120/2,5L	6229718-0B531853	REC32-8M0071007			260/5.7L	0B525982-0F600999	REC32-33189		
140	2508261-3332137	REC32-8M0071007			5.7 ALPHA (2bbl)	0F601000+	REC32-33189		
140	3332138-5157669	REC32-8M0071007			5.7L ALPHA (EFI) TBI	0F355305-0F752399	REC32-33189		
140	5157669-6229717	REC32-8M0071007			5.7L ALPHA (2bbl. -TBI)	0F752400+	REC32-33189		
140/3.0L	6229718-0C856558	REC32-8M0071007			5.7LX ALPHA (4bbl)	0F601000+	REC32-33189		
3.0L/LX	0C856559-0F603999	REC32-8M0071007			5.7LX ALPHA (4bbl. -TBI)	0F752400+	REC32-33189		
3.0LX	0G604000+	REC32-8M0071007			5.7L BRAVO (2bbl. -TBI)	0F752400+	REC32-33189		
140	1538930-1725960	REC32-8M0071007			5.7LX BRAVO (4bbl. -TBI)	0F752400+	REC32-33189		
185 (4bbl)	6330183-6919655	REC32-33189			5.7LX BRAVO (TBI)(GEN +)	0F800300+	REC32-33189		
185 (2bbl)	0A331455-0B527954	REC32-33189			350 Mag. ALPHA	0A635178-0B525981	REC32-33189	REC32-871171	
175/4.3 (2bbl)	0B527955-0D714106	REC32-33189			350 Mag. ALPHA	0B525982-0F600999	REC32-33189		
4.3L (GEN II) (2bbl)	0D714107-0F00877	REC32-33189	REC32-871171		350 Mag. ALPHA (4bbl)	0F601000+	REC32-33189		
4.3L (GEN II) (2bbl)	0F601127-0F802999	REC32-33189		REC27-68714A6	350 Mag. ALPHA (TBI) (Gen+)	0F800300+	REC32-33189		
4.3LX (GEN+) (2bbl)	0F803000+	REC32-33189		REC27-68714A6	350 Mag. BRAVO (MPI)	0F415189-0F601999	REC32-33189		
205 (4bbl)	0A331455-0B527954	REC32-33189	REC32-871171		350 Mag BRAVO (MPI)(GEN+)	0F602000+	REC32-33189		
205/4.3LX (4bbl)	0B527955-0D714639	REC32-33189			300 TEMPEST	6668677-0B430367	REC32-33189		
4.3L (GEN II) (2bbl)	0D714370-0F001219	REC32-33189			320 (EFI)	0A543604-0B157602	REC32-33189		
4.3L (GEN II) (2bbl)	0F001220-0F601126	REC32-33189			320 (EFI)	0B157603-0C622418	REC32-33189		
4.3L (GEN II) (2bbl)	0F601127-0F802999	REC32-33189							
4.3LXH (GEN+) (4bbl)	0F803114+	REC32-33189							
225 (4bbl)	3385721-4166999	REC32-33189							
225-S (4bbl)	3385721-416999	REC32-33189							
200 (2bbl)	6218462-0B525981	REC32-33189	REC32-871171	REC27-68714A6					
200/5.0L (2bbl)	0B525982-0F600999	REC32-33189							
230 (4bbl)	6218462-0B525981	REC32-33189	REC32-871171	REC27-68714A6					
230/5.0LX (4bbl)	0B525982-0F600999	REC32-33189							

# PARTES DEL MOTOR

# ENGINE PARTS









## JUNTAS PARA BASES GM Y FORD

## MARINE GASKETS TO GM & FORD ENGINES







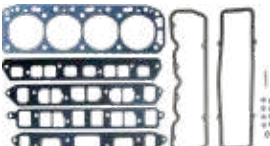

Los Kits están diseñados y catalogados específicamente para aplicaciones marinas. Su calidad es superior a las juntas originales.

The gaskets kits are designed and cataloged specifically for marine engine applications. Their quality is even better than the oem's.

SERIE SERIAL		
1700-17099	KIT JUNTAS DE CULATA (pack individual)	CYLINDER HEAD GASKET (single-packed)
17100-17199	KITS DE CONVERSIÓN Todas las juntas y retenes de aceite que no se encuentran en los kits de culata. Incluye las juntas del cárter y los retenes.	CONVERSION KITS All gaskets and oil seals not found in a Head Set. This includes timing cover gaskets and seals, oil pan gaskets, and rear main bearing seals.
17200-17299	KIT DE DESCARBONIZACIÓN Juntas y retenes necesarios para el trabajo de las válvulas, incluyendo la de culata, tapa de válvula y juntas de colectores de admisión y escape. (Los kits de 4 cyl no contienen las juntas del colector de admisión/escape).	HEAD SETS SERIES All gaskets and seals necessary for a valve grinding job, including cylinder head gaskets, valve cover gaskets, intake & exhaust manifold gaskets (except 4 cyl intake set), and valve stem seals.
17300-17399	KIT DE COLECTOR DE ADMISIÓN Juntas de la parte de admisión del colector, retenes y juntas de la base del distribuidor.	INTAKE MANIFOLD SETS Intake manifold side gaskets, intake manifold end seals, and distributor mounting gasket.
17400-17499	KIT DE COLECTOR DE ESCAPE (de colector a culata)	EXHAUST MANIFOLD (manifold-to-cylinder head gaskets)
17700-17749	KIT DE CONTRARROTACIÓN RETÉN TRASERO DEL CIGÜEÑAL Retenes traseros del cigüeñal diseñados para motores de contrarrotación. (Retenes de rotación normal incluidos en el set de conversión)	REVERSE ROTATION REAR MAIN BEARING SEAL SETS Rear main bearing seals designed to seal a crankshaft which rotates in the opposite direction from normal (Standard rotation seal is included in conversion set)
17750-17799	KIT DE RETENES TAPA DEL CIGÜEÑAL DE CONTRARROTACIÓN Retenes de la tapa del cigüeñal diseñados para motores de contrarrotación. (Retenes de rotación normal incluidos en el set de conversión).	REVERSE ROTATION TIMING COVER SEAL SETS SERIES Timing cover seals designed to seal crankshaft which rotates in the opposite direction from normal (standard rotation seal is included in Conversion set and Timing cover set)
17900-17949	KIT DE TAPA VÁLVULA Todas las juntas de las tapas de las válvulas para sellar el motor.	VALVE COVER SET SERIES All valve cover or push rod cover gaskets (and grommets if required) required to seal one engine.
17950-17999	KIT DE CÁRTER Todas las juntas y retenes del cárter de aceite, o la junta del cárter de aceite de goma moldeada de una pieza, necesarias para sellar un motor.	OIL PAN SETS SERIES All oil pan gaskets & seals, or one-piece molded rubber oil pan gasket, required to seal one engine.









120 / 205L (120 HP)			
	REF	CULATA	CYLINDER HEAD
	REC17000	JUNTA CULATA	CYLINDER HEAD
	REC17200	KIT JUNTAS SUPERIOR	GASKET HEAD SET
	REC17100	KIT JUNTAS INFERIOR (2361802+) Retén 2 piezas, 4 piezas junta cárter.	CONVERSION GASKET SET (2361802+) 2 piece rear main bearing seal & 4 piece oil pan gasket
	REC27-52546	COLECTOR ADMISIÓN-ESCAPE Junta admisión-escape (1666601 - 6229717)	MANIFOLD INTAKE & EXHAUST Intake-Exhaust gasket (1666601 - 6229717)
	REC27-96429	Junta admisión-escape (6229718+)	Intake-Exhaust gasket (6229718+)
	REC17950	CÁRTER KIT JUNTAS CARTER Retén trasero dos piezas, 4 piezas junta cárter.	OIL PAN GASKET OIL PAN SET Two piece rear main bearing seal & 4 piece oil pan gasket
	REC17900	TAPA VÁLVULAS Junta	VALVE COVER Gasket
	REC17903	TAPA EMPUJADORES Junta	PUSH ROD COVER Gasket

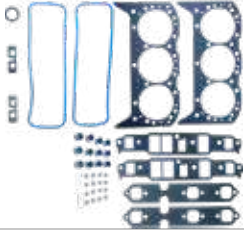

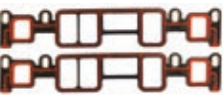
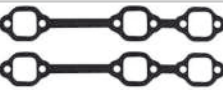

140 / 3.0L, 140 / 3.0LX (115,130, 135, 140 HP)

REF	CULATA	CYLINDER HEAD
 REC17000	JUNTA CULATA	CYLINDER HEAD
 REC17200	KIT JUNTAS SUPERIOR	GASKET HEAD SET
REF	INFERIOR	CONVERSION
 REC17102	KIT JUNTAS Retén 1 pieza. Junta cárter 1 pieza.	GASKET SET 1 piece rear main bearing seal 1 piece oil pan gasket
 REC17100	KIT JUNTAS INFERIOR (2361802+) Retén 2 piezas, 4 piezas junta cárter.	CONVERSION GASKET SET (2361802+) 2 piece rear main bearing seal & 4 piece oil pan gasket
REF	COLECTOR ADMISIÓN-ESCAPE	MANIFOLD INTAKE & EXHAUST
 REC27-96429	Junta (6229718+) excepto 3.0 LX	Gasket (6229718+) excl. 3.0 LX
 REC27-815528	Junta (6229718+) sólo 3.0 LX	Gasket (6229718+) only 3.0 LX
 REC27-53354	Junta (-9229717)	Gasket (-9229717)
REF	CARTER	OIL PAN
 REC17950	KIT JUNTAS Retén trasero dos piezas, 4 piezas junta cárter.	GASKET SET Two piece rear main bearing seal & 4 piece oil pan gasket
REF	TAPA VÁLVULAS	VALVE COVER
 REC17900	Junta	Gasket
REF	TAPA EMPUJADORES	PUSH ROD COVER
 REC17903	Junta	Gasket

4.3L: 155, 175 HP • 4.3LX: 175, 180, 205 HP • 175 & 185 HP 2 BBL. • 205 HP 4 BBL

REF	CULATA	CYLINDER HEAD
 REC17010	JUNTA CULATA Se necesitan dos	CYLINDER HEAD 2 required
 REC17210	KIT JUNTAS SUPERIOR Motor sin eje equilibrado. Incluye juntas tapa válvulas y retenes.	GASKET HEAD SET Engine without balance shaft; valve cover gskts and premium valve stem seals incl.



	REC17211	KIT JUNTAS SUPERIOR Motor con eje equilibrado. Incluye juntas tapa válvulas y retenes.	GASKET HEAD SET Engine with balance shaft; valve cover gskts and premium valve stem seals incl.
	REC17212	KIT JUNTAS SUPERIOR Motor con eje equilibrado. Incluye juntas tapa válvulas y retenes. VORTEC V6 1996+	GASKET HEAD SET Engine with balance shaft; valve cover gskts and premium valve stem seals incl. VORTEC V6 1996+
	REF	INFERIOR	CONVERSION
	REC17110	KIT JUNTAS INFERIOR Motor sin eje equilibrado con retén de 2 piezas y 4 piezas junta cárter. Incluye Junta de cárter.	CONVERSION GASKET SET Engine without balance shaft with 2 pieced rear main bearing seal & 4 pieces oil pan gasket; oil pan gasket incl.
	REC17116	KIT JUNTAS INFERIOR Motor con eje equilibrado con retén de 1 pieza y 1 pieza junta cárter. Incluye Junta de cárter.	CONVERSION GASKET SET Engine without balance shaft with one-piece rear main bearing seal & 1 piece oil pan gasket; oil pan gasket incl.
	REC17117	KIT JUNTAS INFERIOR Motor con eje equilibrado con retén de 1 pieza y 1 pieza junta cárter. Incluye Junta de cárter. VORTEC V6 1996+	CONVERSION GASKET SET Engine without balance shaft with one-piece rear main bearing seal & 1 piece oil pan gasket; oil pan gasket incl. VORTEC V6 1996+
	REF	COLECTOR ADMISION-ESCAPE	MANIFOLD INTAKE & EXHAUST
	REC17310	Junta Admisión-Escape	Intake-Exhaust Gasket
	REC824326002	Junta Admisión Vortec (2 unid.)	Intake Gasket Vortec (2 units)
	REC27-99757	Kit juntas colector - escape	Exhaust gasket set
	REF	CARTER	OIL PAN
	REC17970	KIT JUNTAS CARTER 4 piezas junta cárter. (Retén 2 piezas)	GASKET OIL PAN SET 4 piece oil pan gasket (2 piece Seal)







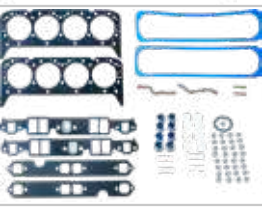
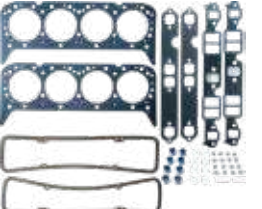

	REC17971	1 junta carter (Retén 1 pieza)	1 piece oil pan gasket (1 piece seal)
	REC27-142471	1 Junta Carter de goma	1 rubber oil pan gasket
	REF	TAPA VÁLVULAS	VALVE COVER
	REC17920	Motor sin eje equilibrado.	Engine without balance shaft
	REC17921	Motor con eje equilibrado.	Engine with balance shaft

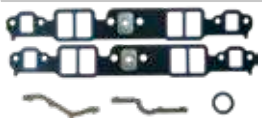
5.0L: 215 HP, 225 HP , 888 (198 HP)  
FORD

	REF	COLECTOR ADMISIÓN-ESCAPE	MANIFOLD INTAKE & EXHAUST
	REC3852455	JUNTA COLECTOR -ESCAPE	OIL PAN - EXHAUST GASKET









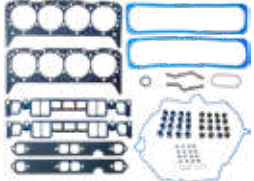

5.0L: 180, 190, 200, 228, 230 HP  
5.0LX: 205, 230 HP; 198/888 (198HP)



	REF	CULATA	CYLINDER HEAD
	REC17020	Se necesitan dos	2 required
	REC17224	Tornillo centro tapa válvulas. Incluye retenes válvulas.	With center bolt desing valve covers. Premium valve stem seals included.
	REC17220	Tornillo en el lateral tapa válvulas. Incluye retenes válvulas.	Rim bolt desing valve covers. Premium valve stem seals included.
	REF	INFERIOR	CONVERSION
	REC17125	Retén de 1 pieza y junta cárter de 1 pieza Incluye junta de cárter.	One-piece rear main bearing seal & 1 piece oil pan gasket. Oil pan gasket included.
	REC17124	Retén de 1 pieza y junta cárter de 1 pieza Incluye junta de cárter. VORTEC V8	One-piece rear main bearing seal & 1 piece oil pan gasket. Oil pan gasket included. VORTEC V8

	REC17120	Retén de 2 piezas y junta cárter de 4 piezas	Two-piece rear main bearing seal & 4 pieces oil pan gasket.
	REF	COLECTOR ADMISIÓN-ESCAPE	MANIFOLD INTAKE & EXHAUST
	REC17320	Kit junta admisión-escape.	Intake-exhaust gasket set.
	REC27-807473A1	JUNTA ADMISIÓN Vortec (2 unid.) Junta de plástico.	INTAKE GASKET Vortec (2 units). Gasket in plastic.
	REC27-33395	Kit juntas colector escape	Oil pan - exhaust gasket set.
	REF	CARTER	OIL PAN
	REC17982	Junta cárter 1 pieza. Junta de cárter incluida.	1 piece oil pan gasket. Molded rubber oil pan gasket included.
	REC17980	Varilla aceite de BABOR con retén trasero de 2 piezas y junta cárter de 4 piezas.	PORT dipstick with 2-piece rear main bearing seal & 4-piece oil pan gasket.
	REC17981	Varilla aceite de ESTRIBOR con retén trasero de 2 piezas y junta cárter de 4 piezas.	STARBOARD dipstick with 2-piece rear main bearing seal & 4-piece oil pan gasket
	REF	TAPA VÁLVULAS	VALVE COVER
	REC17931	Tornillo centro tapa válvulas con juntas.	Molded rubber gaskets incl.
	REC17930	Tornillo en el canto.	Rim bolt desing

**BLACK SCORPION (315 HP) 5.7L: 230, 235, 260 HP • 5.7L BLUE WATER INBOARD 250, 260 HP  
5.7L BRAVO, 240, 250, 270 HP • 5.7L COMP SKI, 250, 260 HP, 255 HP, 300, 300 MR/TR  
350 MAGNUM, 350 MAGNUM TOURNAMENT SKI (240, 250, 265, 270 HP)**

	REF	CULATA	CYLINDER HEAD
	REC17030	Se necesitan dos	2 required
	REC17214	Tornillo centro tapa válvulas. Incluye retenes válvulas.	With center bolt desing valve covers. Premium valve stem seals included.
	REC17230	Tornillo en el lateral tapa válvulas. Incluye retenes válvulas.	Rim bolt desing valve covers. Premium valve stem seals included.





	REC17231	Juntas del colector admisión de plástico. Retenes válvulas incluidos. VORTEC V8 5.0L	Gasket head set with plastic intake manifold gaskets. Premium valve stem. Seals incl. VORTECV8 5.0L
	REC17232	Juntas del colector admisión de plástico. Retenes válvulas incluidos.	Gasket head set with plastic intake manifold gaskets. Premium valve stem. Seals incl.
	REF	INFERIOR	CONVERSION
	REC17125	Retén de 1 pieza y junta cárter de 1 pieza Incluye junta de cárter.	One-piece rear main bearing seal & 1 piece oil pan gasket. Oil pan gasket included.
	REC17124	Retén de 1 pieza y junta cárter de 1 pieza Incluye junta de cárter. VORTEC V8	One-piece rear main bearing seal & 1 piece oil pan gasket. Oil pan gasket included. VORTEC V8
	REC17120	Retén de 2 piezas y junta cárter de 4 piezas	Two-piece rear main bearing seal & 4 pieces oil pan gasket.
	REF	COLECTOR ADMISIÓN-ESCAPE	MANIFOLD INTAKE & EXHAUST
	REC17320	Kit Juntas Admisión-Escape	Intake-Exhaust Gasket Set
	REC27-807473A1	JUNTA ADMISIÓN Vortec (2 unid.) Junta de plástico.	INTAKE GASKET Vortec (2 units) Gasket in plastic.
	REF	CARTER	OIL PAN
	REC17982	Junta cárter 1 pieza. Incluye Junta de cárter.	1 piece oil pan gasket. Molded rubber oil pan gasket included.
	REC17980	Varilla aceite de BABOR con retén trasero de 2 piezas y junta cárter de 4 piezas.	PORT dipstick with 2-piece rear main bearing seal & 4-piece oil pan gasket.
	REC17981	Varilla aceite de ESTRIBOR con retén trasero de 2 piezas y junta cárter de 4 piezas.	STARBOARD dipstick with 2-piece rear main bearing seal & 4-piece oil pan gasket
	REF	TAPA VÁLVULAS	VALVE COVER
	REC17931	Tornillo centro tapa válvulas con juntas.	Molded rubber gaskets incl.







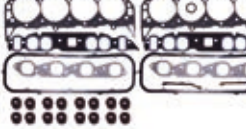
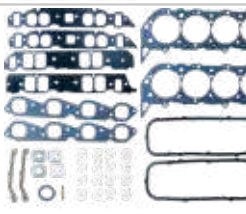

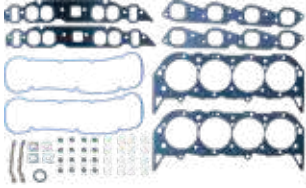

	REC17930	Tornillo en el canto.	Rim bolt desing
	REF	RETÉN DISTRIBUCIÓN	OIL SEAL TIMING COVER
	REC3853341	Reten contrarotación Motor sin tapa distribución de plástico.	Reverse rotation oil seal Engines w/o plastic timing cover.

**5.8L 233 (3258728 - 4175499) (233 HP)  
255 (3258728 - 4175499) (255 HP)  
FORD**







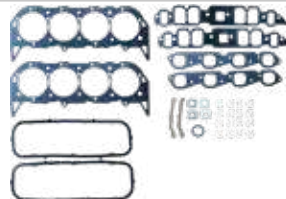

	REF	COLECTOR ADMISIÓN-ESCAPE	MANIFOLD INTAKE & EXHAUST
	REC3852455	Junta escape.	Exhaust gasket.

**7.4L 454 V8: 420 HP GEN IV & V • 425 (385, 400, 425 HP GEN IV & V) • 525 SC (500 HP GEN V)  
7.4L BLUE WATER INBOARD (-D715493) (310, 340 HP GEN IV)  
7.4L BLUE WATER INBOARD (D715494+) (310 HP GEN V)  
7.4L BRAVO (-D603117) (300, 330 HP GEN. IV)  
7.4L BRAVO I (D603118+) (300, 330 HP GEN V)  
7.4L BRAVO II (D603118+) (300, 330 HP GEN V)  
7.4L BRAVO III (D603118+) (3350 HP GEN V)  
7.4L EFI (F215800+) (310 HPGEN V), 330, 340, 350, 370TRS, • 400 TRS GEN IV, 450 HP GENE V  
454 MAGNUM ALPHA (A631894 - B785148) (330 HP GEN IV)  
454 MAGNUM BRAVO (B721206 - D805068) (350, 365 HP GENE IV)  
454 MAGNUM BRAVO (D805069+) (350 HP GENE V)**

	REF	CULATA	CYLINDER HEAD
	REC17040	Gen IV exc. H.O. Se necesitan dos	Gen IV exc. H.O. 2 required
	REC17046	JUNTA CULATA Gene IV sólo H.O. Se necesitan 2.	CYLINDER HEAD Gene IV H.O. only 2 required
	REC17042	Gen IV & V. Se necesitan 2.	Gen IV & V. 2 required
	REC17240	Gen IV exc. H.O. con admisión ovalada. Se incluye retenes de válvula.	Gen IV exc. H.O. with oval intake ports. Premium valve stem seals included.
	REC17241	KIT JUNTAS SUPERIOR Gene IV exc. H.O. con admisión rectangular. Se incluye retenes de válvula	GASKET HEAD SET Gen IV exc. H.O. w/rectangular intake ports; premium valve stem seals incl.
	REC17246	KIT JUNTAS SUPERIOR Gene IV sólo H.O. con admisión rectangular. Se incluye retenes de válvula	GASKET HEAD SET Gen IV only H.O. w/rectangular intake ports; premium valve stem seals incl.
	REC17242	KIT JUNTAS SUPERIOR Gene V & VI H.O. con admisión ovalada. Se incluye retenes de válvula.	GASKET HEAD SET Gen V & VI or H.O. w/oval intake ports; premium valve stem seals incl.

	REC17243	Gen V & VI solo H.O. con admisión rectangular, juntas tapa válvulas y retenes incluidos.	Gen V & VI, H.O. only, with rectangular intake ports valve cover gaskets and premium valve stem seals incl.
	REF	INFERIOR	CONVERSION
	REC17140	Gene IV con retén trasero de dos piezas y junta cárter de 4 piezas.	Gene IV w/two piece rear main bearing seal & four piece oil pan gasket.
	REC17985	Gen IV MK IV. 4 piezas.	Gen IV MK IV. 4 pieces
	REC17146	Gene VI con retén trasero de una pieza y junta cárter de 1 pieza. Junta cárter incluida.	Gene VI w/one piece rear main bearing seal & one piece oil pan gasket. oil pan gasket. incl.
	REF	COLECTOR ADMISIÓN-ESCAPE	MANIFOLD INTAKE & EXHAUST
	REC17341	KIT JUNTA ADMISIÓN Gene IV, V y VI sólo H.O. con admisión rectangular. Gene IV, excl. H.O. con admisión rectangular.	INTAKE GASKET SET Gene IV, V & VI, H.O. only w/rectangular intake ports Gene IV excl. H.O. w/rect. intake ports
	REC17340	KIT JUNTA ADMISIÓN Gene IV, excl. H.O. con admisión oval. Gene V y VI exc. EFI y H.O. con admisión ovalada.	INTAKE GASKET SET Gene IV excl. H.O. w/oval intake ports Gene V & VI, excl. EFI & H.O. w/oval intake ports
	REC17342	KIT JUNTA ADMISIÓN Gene V y VI sólo EFI	INTAKE GASKET SET Gene V & VI, EFI only
	REC27-46820	KIT JUNTA ESCAPE Gene IV, V y VI.	EXHAUST GASKET SET Gene IV, V & VI
	REF	RETÉN TRASERO CIGÜEÑAL	Crankshaft rear seal
	REC26-14756	Gene IV Retén Contrarrotación dos piezas	Gene IV Reverse rotation oil seal Two- pieces
	REF	TAPA VÁLVULAS	VALVE COVER
	REC17935	Gen IV	Gen IV
	REC17937	Gen V & VI	Gen V & VI

8.2L 502 V8 HP465 (465 HP GEN. V) HP 600 SC (550HP GEN. V)  
 8.5L (-D857199) (400 HP GEN. IV)  
 8.2L (D857200 - F819619) (400 HP GEN.V) 500 (470 HP GEN V)  
 502 MAGNUM BRAVO (-D824588) (390HP GEN IV)  
 502 MAGNUM BRAVO (D824589+) (390 & 415 HP GEN. V)

REF	CULATA	CYLINDER HEAD
 REC17048	Gen IV, V & VI. Se necesitan 2.	Gen IV, V & VI. 2 required
 REC17248	Gen IV & Gene V exc. EFI. Se incluye retenes de válvula y juntas tapa válvulas.	Gen IV & Gen V exc. EFI Premium valve stem seals & valve cover gaskets included.
 REC17207	Gen V & VI solo EFI. Se incluye retenes de válvula y juntas tapa válvulas.	Gen V & VI EFI only. Premium valve stem seals & valve cover gaskets included.
REF	INFERIOR	CONVERSION
 REC17140	Gene IV con retén trasero de dos piezas y junta cárter de 4 piezas.	Gene IV w/two piece rear main bearing seal & four piece oil pan gasket.
 REC17146	Gene VI con retén trasero de una pieza y junta cárter de 1 pieza. Junta cárter incluida.	Gene VI w/one piece rear main bearing seal & one piece oil pan gasket. oil pan gasket. incl.
REF	COLECTOR ADMISIÓN-ESCAPE	MANIFOLD INTAKE & EXHAUST
 REC17341	Gen IV, V y VI sólo H.O. con admisión rectangular. Gene IV, excl. H.O. con admisión rectangular.	Gen IV, V & VI, H.O. only with rectangular intake ports. Gen IV excl. H.O. with rect. intake ports.
 REC17340	JUNTA ADMISIÓN Gen V & VI sólo EFI.	INTAKE GASKET Gen V & VI only EFI.
REF	RETÉN TRASERO CIGÜEÑAL	CRANKSHAFT REAR SEAL
 REC26-14756	Gen IV. Retén Contrarrotación dos pieza.	Gen IV. Reverse rotation oil seal Two- pieces
REF	TAPA VÁLVULAS	VALVE COVER
 REC17935	Gen IV	Gen IV
 REC17937	Gen V & VI	Gen V & VI

## CULATA

## CYLINDER HEAD

### CULATA

### CYLINDER HEAD

REF	OEM	
	7358	
	938-4625	
REC938-7499	938-7358	CULATA STD 5.7 - 1967-85
	938-7499	
	FI1101190	



REF	OEM	
	883297	
	883297R1	
	883297R50	
REC938-803860T	8M0188302	STD V8 5.7L/6.2L VORTEC
	938-803860T	
	938-883297R1	
	938-8M0115137	



REF	OEM	
	802556T	
REC938-8M0087884	8M0087884	GM305VORTEC (5.0L) NUEVA
	938-802556	
	938-8M0087884	



### TORNILLOS

### SCREW

REF	OEM	
MP0003-029	10-8M0000483 8M0000483	



REF	OEM	
REC10501	10-34510 34510 FI1100609	181 RX



## JUNTAS MOTOR

## ENGINE GASKETS

470, 485, 488, 165, 170, 180 & 190 HP  
4 CYL EN LINEA | IN LINE

	REF	OEM	MOD.		UN.	
1	REC26-75624	26-75624		RETÉN VÁLVULA	VALVE STEM SEAL	8
2	REC27-73666	27-73666	224 CID (3.7 L)	JUNTA TAPA VÁLVULAS	VALVE COVER GASKET	1
3	REC27-68715	27-68715	460 CID	JUNTA COLECTOR ESCAPE	EXHAUST MANIFOLD GASKET	1
4	REC12001	34532, 35330, 58284, 99948, FI1100651, FI1101207	181		PUSH ROD	

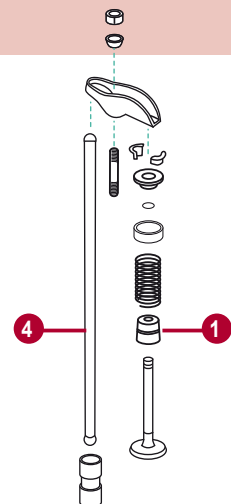



## JUNTAS DISTRIBUCIÓN

## TIMING GASKETS

### JUNTA TAPA DISTRIBUCIÓN

REF	OEM	
REC27-49953	27-49953	4 et 6 Cyl. GM120, 140, 160/165, 2.5L, 3.0LX/L (1963+)





REF	OEM	
REC27-68714A6	27-68714	224 CID 165, 170, 180, 190, 470, 485 et 488



### TIMING CHAIN COVERS GASKETS

REF	OEM	
REC27-850456	27-85046	454, 502 / 7.4 et 8.2L GEN V et VI (1996+) Race Sterndrive 500, 520, 525, 540, 565, 575, 600, 662, 700



REF	OEM	
REC27-14250	27-14250	V6 et V8 (-1997)





## CIGÜEÑAL

## CRANKSHAFT

### RETENES CIGÜEÑAL

REF	OEM	
REC26-14240	26-14240	4.3, 5.0, 5.7L Standard Rot.



REF	OEM	
REC26-14756	26-14756	7.4, 8.2L (1991+)



REF	OEM	
RECBS40013	26-814622 58203 814622 FI5110026	GM V8



### CRANKSHAFT SEAL

REF	OEM
REC3853341	36-97335
REC26-8219471	26-8219471



REF	OEM
REC26-14240	26-14240
REC26-811554	26-811554



### JUNTA

### GASKET

REF	OEM
REC27-14241	14241 27-14241 27-881715 27-883964T 881715



# VÁLVULAS

# VALVES

## COVER: PUSH ROD 181

## COVER: PUSH ROD 181

REF	OEM
MP0014-401	814702 FI1100635



## VÁVULA ADMISIÓN

## INTAKE VALVE

REF	OEM	Icon
REC70817B	26-97664 26-976641 26-8M0050563	

4.3L, 5.0L, Et 5.7L old Et MPI (1983-97)



## RETENES VÁLVULAS

## SEAL VALVE

REF	OEM	Icon
REC26-34217	26-34217	

4 en línea y 6 cil, GM antiguos | early | V6/V8



REF	OEM	Icon
REC26-75988	26-75988	

330 (4623115+)  
340 (5889914+)  
454 Mag (A631894+)



## TAPA MUELLE DE LA VALVULA

## CAP: INLET VALVE SPRING 350

REF	OEM	Icon
MP0007-378	48348 FI1101188	



## RETÉN VÁLVULA ESCAPE

## EXHAUST VALVE SEAL

REF	OEM	Icon
REC26-8M0150312	26-8M0150312 26-804507	

V6 Et V8 small Vortec Et MPI



## RETÉN ADMISIÓN Y ESCAPE

## INTAKE & EXHAUST VALVE

REF	OEM	Icon
REC26-75624	26-75624 26-75413	

165, 170, 180, 190 4 CIL. (224 cid) (6916779+)  
888 (2bb) Ford 302 V8 (1971-77)  
3.7 L, LX (1980-89)  
470 (1976-81) 488 (1983-84)



## VÁLVULAS DE ADMISIÓN

## INTAKE VALVE

REF	OEM	Icon
REC13504	97661	
REC13506	97661	

3.0L (49.3-8.7-124)

262 (49-8,8-124)

REF	OEM	Icon
REC13507	809992 8M0146076	
REC802555	802555	

262 VORTEC (1993+)  
(49,2-8,7-124)  
5.0L VORTEC (1996+)  
(46,5-8,7-124) (1 slot)



## VÁLVULAS DE ESCAPE

## EXHAUST VALVE

REF	OEM	Icon
REC13501	52367 810850 824317	
REC13502	85803 87284 87824 FI1100810	
REC13508	35323 FI1100255	
REC13505	8243171	

3.0L (40.7-8.7-125)

2.5L (38.1-8.7-125)

5.0L Et 5.7L (38-9,4-125) (2 slots)

4.3V YEt 5.7V 96+



## TAPA DE VÁLVULAS

REF	OEM	
MP0014-100	65635A16	181
	65635A5	
	65635A8	
	851036	
	851036T	
	8M0122491	



## TIMING-COVER

REF	OEM
REC59341A1	11973
	26-97335
	42750
	54799
	59341
	59341A1
	79223
	97335
	F11101076
	F11101263



## INDICADOR DE TIEMPO DE DISTRIBUCIÓN

REF	OEM
MP0011-045	75435A1 F11101059

## POINTER: TIMING 350 PM



## RETENES

### GUÍA RETENES ACEITE

REF	OEM	Ø EJE SHAFT Ø (")	Ø EXTERIOR OUTER Ø (")
REC26-12224	26-12224	1.1875	1.6875
REC26-76868	26-14077	1.1875	1.6875
REC26-14240	26-14240	3.8125	4.5000
REC26-16977	26-16977	0.8750	1.2500
REC26-32511	26-32511	1.2500	2.0000
REC26-419533	26-41953	1.1875	1.8750
REC26-43035	26-43035	1.0625	1.4375
REC26-43036	26-43036	1.0312	1.4687
REC26-455771	26-45577 1	0.3125	0.4375
REC26-55682	25-55682	1.0000	1.2500
REC26-56397	26-56397	0.7500	1.1250
REC26-66302	26-66302	1.2500	1.8750
REC26-69188	26-69188	0.8750	1.2500
REC26-69189	26-69189	0.8750	1.3125
REC26-70081	26-70081	1.1875	1.7500

## SEALS

### OIL SEALS GUIDE

REF	OEM	Ø EJE SHAFT Ø (")	Ø EXTERIOR OUTER Ø (")
REC26-72785	26-72785	0.7500	1.8750
REC26-76868	26-76868	1.1875	1.6875
REC321466	26-79831	0.7500	1.1250
REC26-861694	26-805080	2.5000	3.1875
REC26-807006	26-807006	1.6875	2.2500
REC26-8164641	26-8164641	0.3750	0.7500
REC26-821092	26-821092	1.5000	2.2500
REC26-823894	26-823894	2.2500	3.0000
REC26-89238	26-89238	0.8750	1.5000
REC26-90562	26-90562	0.7500	1.2500
REC26-965031	26-965031	0.8750	1.3750
REC26-43993	26-43993	1640	2132
REC26-16977	26-16977	875	1250
REC26-55682	26-55682	1000	1253
REC26-12709	26-12709	0,5	0,6875

## GUÍA TÓRICAS

REF	OEM	REF	OEM
REC308627	25-20826	REC0307239	25-33504
REC25-21836	25-21836	REC25-457101	25-457101
REC125017	25-23145	REC310414	25-47254
REC25-25439	25-25439	REC0554545	25-47632
REC302588	25-26722	REC25-48171	25-48171
REC303347	25-26802	REC25-33465	25-54029
REC25-30224	25-30224Q	REC25-55801	25-55801
REC25-30613	25-30613	REC3852045	25-62704
REC3852866	25-31986	REC331188	25-65936
REC25-32546	25-32546	REC25-67202	25-67202
REC25-33145	25-33145	REC25-70937	25-70937
REC25-33465	25-33465	REC3852865	25-805331

## O-RING GUIDE

REF	OEM
REC25-90011	25-90011
	25-94288
REC25-94288	896523
	94288
REC25-97387	25-97387
	97387
REC302035	25-48452

REF	OEM	ESPEJOR THICKNESS	Ø INTERIOR INSIDE Ø	Ø EXTERIOR OUTER Ø	REF	OEM	ESPEJOR THICKNESS	Ø INTERIOR INSIDE Ø	Ø EXTERIOR OUTER Ø
REC25-35029	25-35029 35029 802231 882613	1/8	31/8	33/8	REC326649	25-30224 25-39695 25-45711 25-8M0204651 27018 30224 30224Q 45711 846361 F455342	3/32	5/8	13/16
REC301967	25-36318 36318	3/32	13/16	1					
REC302537	25-33466 33466	3/32	13/8	19/16					
REC304174	25-32509 25-45253 32509 806609 F461342	1/16	1/2	5/8					
REC305123	25-33756 33756	1/8	33/4	4					
REC307450	802018 20365	1/16	7/16	9/16	REC326849	25-39695 39695 846361 20195	1/8	41/4	41/2
REC310584	25-35276 35276	1/8	3/4	1	REC339543	201951 25-201951	3/32	1/2	11/16
REC313175	25-67202 67202	1/8	43/4	5	REC3852928	25-26855 26855	1/8	15/8	17/8
REC313754	802251	3/32	21/16	21/16	REC553126	25-31305 31305	1/8	31/4	31/2
REC314491	802257	1/16	1	11/8	REC909048	802149	3/32	1/2	11/16
REC314728	802258	3/32	21/8	25/16	REC909139	802149	1/8	1	11/4
REC318717	802037	3/16	11/2	1 7/8	REC909140	25-58390 58390	1/16	11/16	113/16
REC319085	802039	3/16	11/8	11/2	REC910238	802151 802383	1/8	51/4	51/2

CARTER

OIL PAN

REF	OEM	
REC809910	14259 809910 8M0150300 F1101295	MPI/GXI



REF	OEM	
RM810845	810845 810845T 8M0122492	3.0LX (90-98)



REF	OEM	
REC15353	13840A1 805930A1	350 (86+)



TAPÓN ACEITE

OIL CAP

REF	OEM
REC27-49955	27-49955 27-8M0077608 49953 49955 8M0077608



# PISTONES

# PISTONS

## KITS PISTONES

REF	OEM	
RM733-810852	38191	3.0LX
	733-803850T	
	733-810852	
	803850T	
	810852	



## PISTONS SETS

REF	OEM	
REC10006	735-835001T	STD 4.3/5.7 1996-2008
	735-850097	
	835001T	



## KIT AROS

REF	OEM	
REC11001	17464	262/350 FALDA 81 MM
	39-17464	

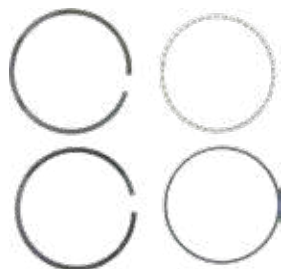

## RING SET

REF	OEM	
REC11004	17464	V6 / V8 1996>
	39-17464	
	39-801861	
	39-8018611	
	8018611	

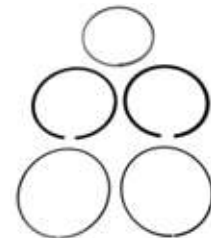

## KIT COJINETES DE BANCADA

REF	OEM	
REC13013	23-818467	0.10 305
	818467	
REC13012	23-818465	350
	818465	



## MAIN BEARING KITS

## COJINETE DE BIELA

REF	OEM	
RM23-804982	23-804982	3.0LX & GS NEWER
REC13001	15961	181 350
	23-85701	
	52221	
	85701 FI1100305	
REC13002	1596110	181 350
	23-85704	
	52224	
	85704 FI1100573	
REC13024	1596120	181 350 305
	23-85705	
	52225	
	85705 FI1100382	



## ROD BEARING

REF	OEM	
REC13011	23-811858 23-811858001 811858001	262 010 010
REC13010	11992001 23-11992 23-11992001	262 STD STD
REC13019	23-85726001 39-827651T 85726001	454 GEN. V
REC13018	23-85691 69887 85691	454 MKIV G.V 0.10



# SISTEMA DE ESCAPE Y ADMISION

# EXHAUST & INTAKE SYSTEM

## DESPIECES COLECTORES Y CODOS

## MANIFOLDS & ELBOWS PARTS

140HP GM181  
4 CYL (1968-82)

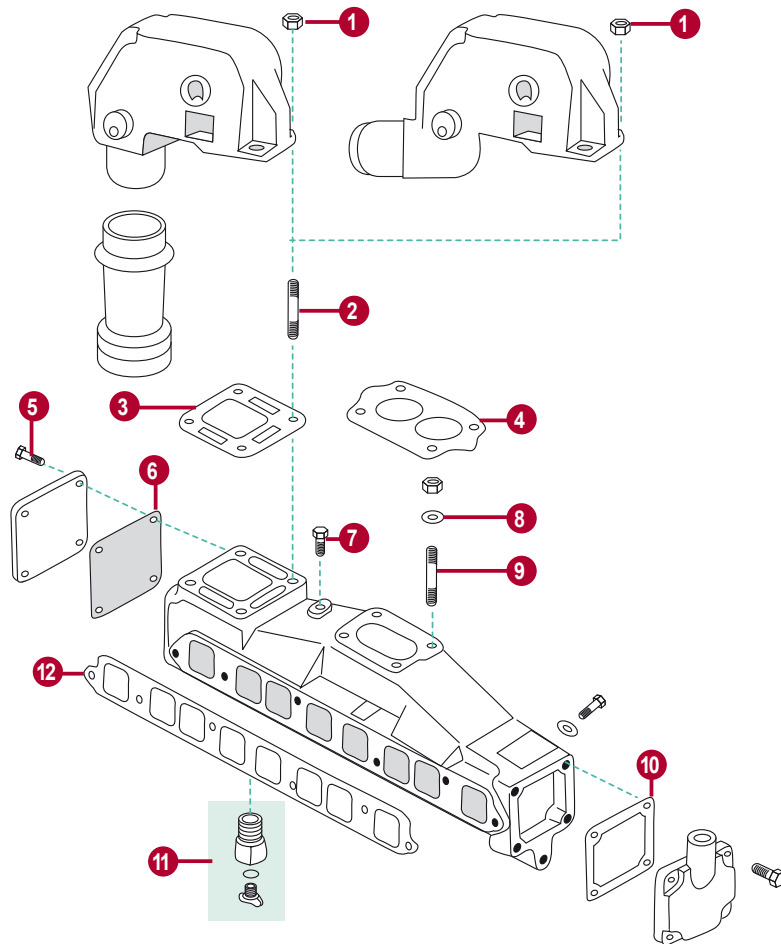

REF OEM

HOT26371-MK

	REF	OEM			UN.
1	REC46335	46335	TUERCA	FLANGE SERRATED NUT	4
2	REC16-49545	16-49545	ESPARRAGO CODO	STUD	4
3	REC27-99777Q02	27-99777Q02	JUNTA CODO	GASKET EXHAUST MANIFOLD TO ELBOW	1
4	REC27-64692	27-64692	JUNTA BASE CARBURADOR	GASKET CARBURETOR BASE	1
5	RM10-25299	10-824941	TORNILLO TAPA	SCREW END CAP	4
6	REC27-807218	27-807218	JUNTA TAPA	GASKET END CAP	1
7	REC22-36382	22-36382	TAPON	PLUG	1
8	REC12-20084	12-20084	ARANDELA	WASHER CARBURETOR	4
9	REC16-70236	16-70236	ESPARRAGO CARBURADOR	STUD CARBURETOR	4
10	REC27-480431	27-480431	JUNTA TAPA	GASKET END CAP	1
11	REC13980	22-806608A1	TORNILLO DRENAJE	STRAIGHT FITTING	1
12	REC27-53354	27-53354	JUNTA COLECTOR	GASKET EXHAUST MANIFOLD	1

2.5L GM 153 4 CYL  
3.0L 4 CYL (1983-89)

MODELO ANTIGUO  
OLD STYLE OPTION

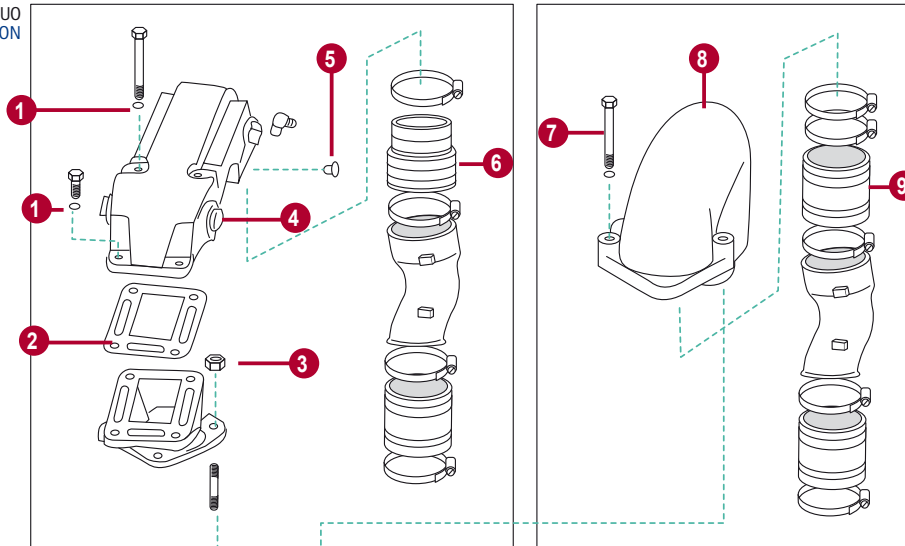

MODELO MODERNO  
NEW STYLE OPTION

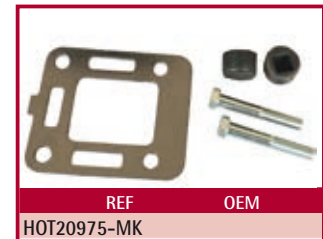
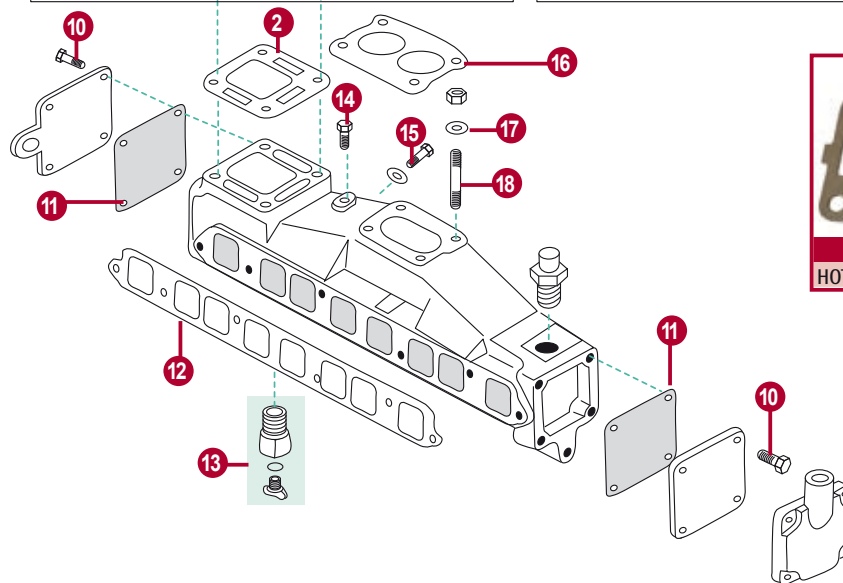

	REF	OEM		UN.	
1	REC13-35048	13-35048	ARANDELA	LOCKWASHER	4
2	REC27-99777Q02	27-99777Q02	JUNTA COLLECTOR ESCAPE A CODO	GASKET EXHAUST MANIFOLD TO ELBOW OR ADAPTOR	2
3	REC46335	46335	TUERCA	FLANGE SERRATED NUT	4
4	REC22-41622	22-41622	TAPON	PLUG EXHAUST ELBOW	4
5	REC22-328022	22-328022	TAPÓN	PLUG	1
6	REC70981A3	70981A3	FUELLE ESCAPE	EXHAUST BELLOW (USE WITH 2-PIECE EXHAUST ELBOW)	1
7	REC10-668631	10-668631	TORNILLO	SCREW	2
8	MAR076	12076A2	CODO ESCAPE	EXHAUST ELBOW ASSEMBLY	
9	REC32-44348001	32-44348001	FUELLE ESCAPE 4"	EXHAUST BELLOW EXHAUST ELBOW 4"	1
10	RM10-25299	10-824941	TORNILLO COLECTOR ESCAPE	SCREW END CAP TO EXHAUST MANIFOLD	8
11	REC27-807218	27-807218	JUNTA	GASKET END CAP	2
12	REC27-96429	27-96429	JUNTA CODO ESCAPE	GASKET EXHAUST MANIFOLD	1
13	REC13980	22-806608A1	RACORD COLECTOR	STRAIGHT DRAIN KIT	1
14	REC22-36382	22-36382	TAPÓN	PLUG	1
15	REC10-53728	10-53728	TORNILLO	SCREW (NEW DESIGN)	3
16	REC27-8079821	27-8079821	JUNTA BASE CARBURADOR (MERCAB)	GASKET CARBURETOR BASE (MERCAB)	1
	REC27-64692	27-64692	JUNTA BASE CARBURADOR (ROCHESTER)	GASKET CARBURETOR BASE (ROCHESTER)	1
17	REC12-20084	12-20084	ARANDELA	WASHER CARBURETOR	4
18	REC16-70236	16-70236	ESPARRAGO	STUD CARBURETOR	4

Para determinar el tipo de carburador (Rochester / Mercab) ver medida de junta:  
To determine the type of carburetor (Rochester / Mercab) see joint measurement:



3.0L & 3.0LX GM 181  
4 CYL (1990+)

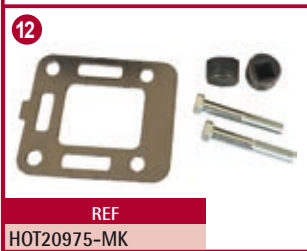

REF  
HOT20975-MK

	REF	OEM		UN.	
1	REC10-668631	10-668631	TORNILLO	SCREW	2
2	REC12-20084	12-20084	ARANDELA	WASHER	1
3	REC13980	22-806608A1	RACORD COLECTOR	STRAIGHT DRAIN KIT	1
4	REC27-815528	27-815528	JUNTA COLECTOR	GASKET EXHAUST MANIFOLD	1
5	MAR076	12076A2	CODO ESCAPE	EXHAUST ELBOW	1
6	REC27-99777Q02	27-99777Q02	JUNTA CODO ESCAPE A COLECTOR	GASKET EXHAUST MANIFOLD TO ELBOW	1
7	REC32-44348001	32-44348001	FUELLE CODO ESCAPE 4"	EXHAUST BELLOW 4"	1
8	REC27-8079821	27-8079821	JUNTA CARBURADOR MERCAB (NO TKS)	CARBURATOR GASKET MERCAB (NO TKS)	1
9	REC10-53728	10-53728	TORNILLO	SCREW	2
10	REC16-806300	16-806300	ESPARRAGO	STUD	3
11	REC46335	46335	TUERCA	FLANGE SERRATED NUT	3
12	HOT20975-MK		KIT MONTAJE	MOUNTING KIT	
13	MAR966	860235A03	COELCTOR	MANIFOLD	1

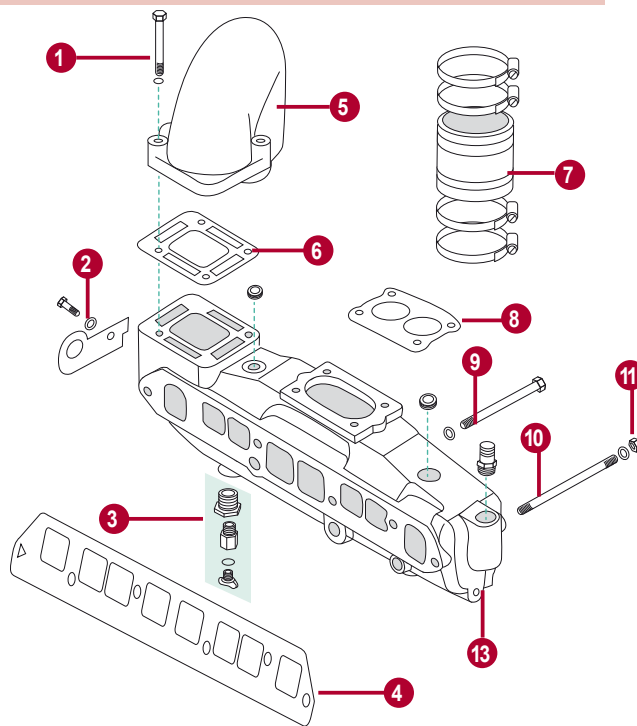

3.0L MPI

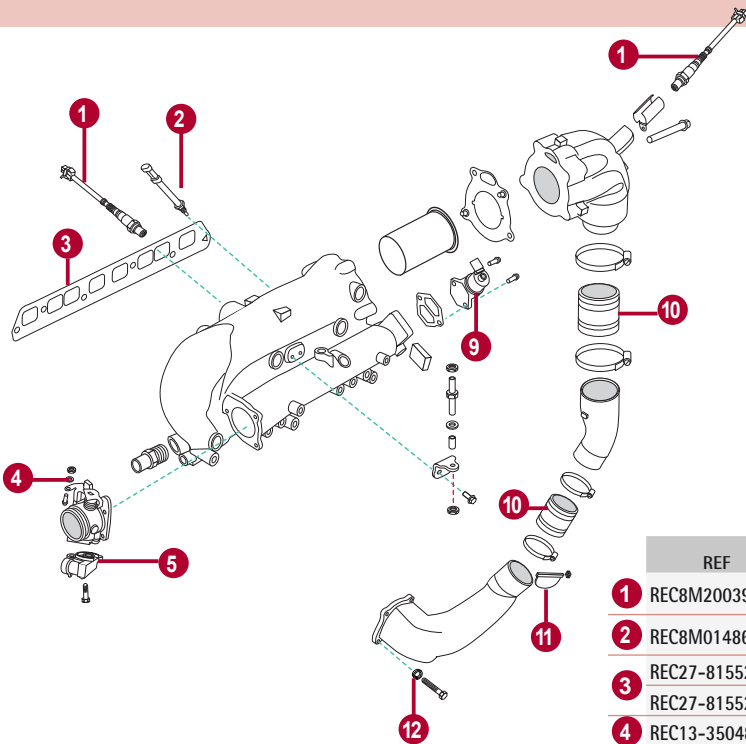

	REF	OEM		UN.	
1	REC8M2003959	8M2003959	SENSOR DE OXÍGENO	OXIGEN SENSOR	2
2	REC8M0148668	8M0148668	SENSOR TEMPERATURA	TEMPERATURE SENSOR	1
3	REC27-815528	27-815528	JUNTA COLECTOR ESCAPE	MANIFOLD GASKET	1
4	REC13-35048	13-35048	ARANDELA	WASHER	1
5	REC8M0125617	8M0125617	SENSOR DE POSICIÓN	POSITION SENSOR	1
9	REC862998	862998	VÁLVULA AIRE IDLE	VALVE IDLE AIRE	1
10	REC32-44348001	32-44348001	TUBO ESCAPE	TUBE EXHASUT	1
11	REC60930	60930	PALOMILLA ESCAPE	SHUTTER WATER EXHAUST	1
12	PAGB/T93-10	13-41471	ARANDELA	LOCKWASHER	4

165, 170, 180, 190, 470, 485, 488  
3.7L & 3.7LX MCM 224 CID 4 CYL (1980-89)

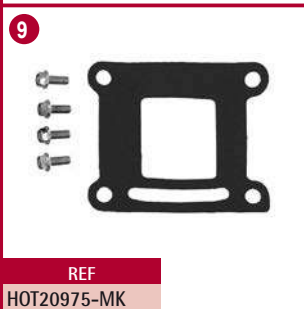

REF  
HOT20975-MK

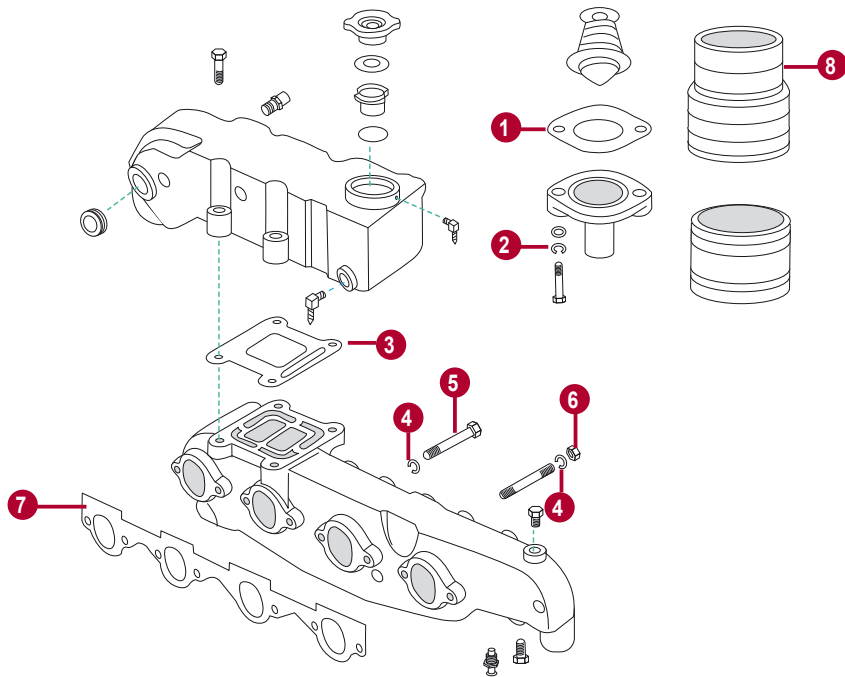

	REF	OEM		UN.	
1	REC27-89656-1	27-896561	JUNTA	GASKET	1
2	REC13-39107	13-39107	ARANDELA	LOCKWASHER	2
3	REC27-18272	27-18272	JUNTA CODO A COLECTOR	GASKET - ELBOW TO MANIFOLD	1
	REC27-856705	27-856705	JUNTA COLECTOR DE HIERRO	GASKET FOR IRON MANIFOLD	1
4	REC13-35048	13-35048	ARANDELA	LOCKWASHER	3
5	REC22-73379	10-74727	TORNILLO	SCREW	3
6	REC46335	46335	TUERCA	FLANGE SERRATED NUT	1
7	REC27-68715	27-68715	JUNTA COLECTOR ESCAPE	GASKET - EXHAUST MANIFOLD	1
8	REC70981A3	70981A3	FUELLE ESCAPE	EXHAUST BELLOW	1
9	HOT20975-MK		KIT PARA COLECTOR DE FUNDICIÓN	KIT FOR CAST IRON MANIFOLD	

GM 160, 165, 200CID, 250, 292CID  
6 CYL IN LINE

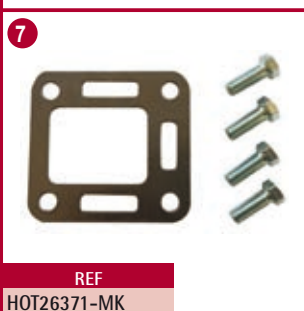

REF  
HOT26371-MK

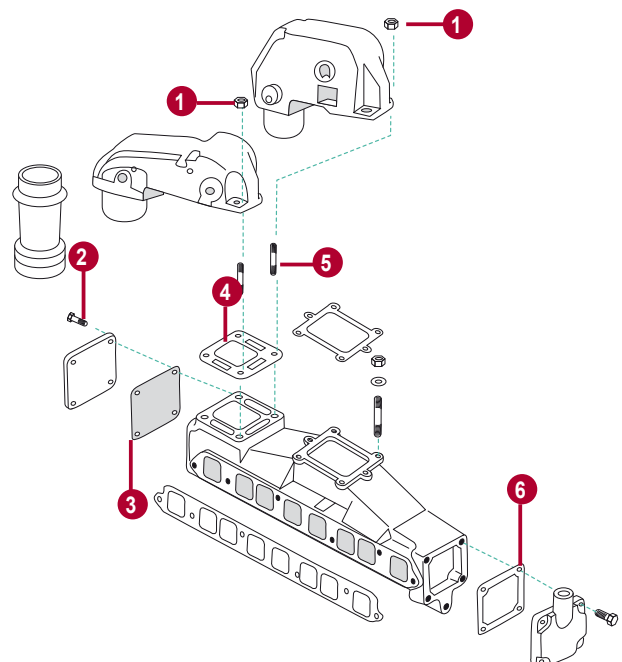

	REF	OEM		UN.	
1	REC46335	46335	TUERCA	NUT	4
2	RM10-25299	10-824941	TORNILLO	SCREW END CAP	4
3	REC27-807218	27-807218	JUNTA TAPA	GASKET END CAP	1
4	REC27-99777Q02	27-99777Q02	JUNTA COLECTOR A CODO	GASKET EXHAUST MANIFOLD TO ELBOW	1
5	REC16-49545	16-49545	ESPÁRRAGO	STUD	4
6	REC27-480431	27-480431	JUNTA TAPA	GASKET END CAP	1
7	HOT26371-MK		KIT MONTAJE CODO HOT26371	MOUNTING KIT ELBOW HOT26371	

## 4.3L CARB MPI ALPHA/BRAVO

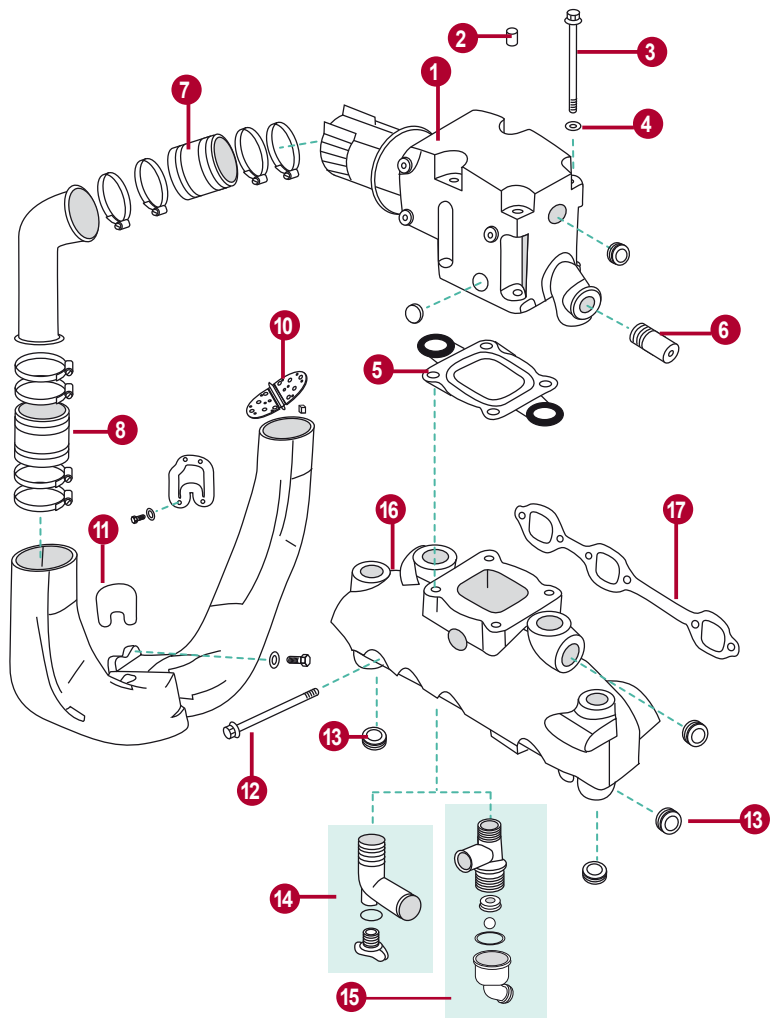
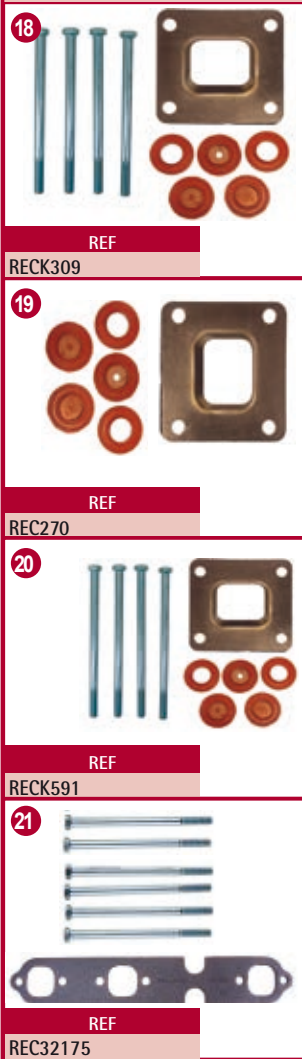

	REF	OEM		UN.	
1	MAR309	864309T02	CODO BAJO 17 cm	ELBOW LOW 17 cm	2
	MAR591	864591T02	CODO ALTO 20,5 cm	ELBOW HIGH 20,5 cm	2
2	REC22-73379	22-73379	TAPÓN	PLUG	1
3	REC10-43749	10-43749	TORNILLO	SCREW	8
4	REC13-35048	13-35048	ARANDELA	LOCK WASHER	8
5	REC270	27-864547A02	JUNTA CODO - COLECTOR	ELBOW-MANIFOLD GASKET	1
6	REC19-864689	19-864689	TAPÓN	PLUG	2
7	REC32-44348001	32-44348001	FUELLE ESCAPE	EXHAUST BELLOW	2
8	REC32-14358001	32-14358001	FUELLE ESCAPE COLECTOR	EXHAUST BELLOW	2
10	REC807166A1	807166A1	PALOMILLA ESCAPE	WATER SHUTTER	2
11	REC41802	41802	RETÉN TRANSON	TRANSON GASKET	1
12	REC10-53728	10-53728	TORNILLO	SCREW	6
13	PAF15-07010004	479452	TAPÓN 1/8"	PLUG 1/8"	1
14	REC862210A01	22-862210A01	KIT TAPÓN Y CONDUCTO	ELBOW AND PLUG KIT	1
15	REC22-863786A1	22-863786A1 863786	CONECTOR	DRAIN FITTING	
16	MAR612	864612T01	COLECTOR	MANIFOLD	2
17	REC27-99757	27-99757	JUNTA COLECTOR	MANIFOLD GASKET	2
18	RECK309		KIT TORNILLOS CODO Y JUNTA	ELBOW GASKET & BOLT KIT	
19	REC270	27-864547A02 27-864550A02 27-864549A02	KIT JUNTA CODO-COLECTOR	ELBOW-MANIFOLD GASKET	
20	RECK591		KIT PARA MAR591	KIT FOR MAR591	
21	REC32175		KIT TORNILLOS COLECTOR Y JUNTA	MANIFOLD GASKET & ELBOW KIT	

262 MAG (TBI), 4.3L (GEN+), 4.3 L EFI (GEN+), 4.3 LH (GEN+), 4.3LX (GEN+), GM 262 V6 (1996-01)

PIEZAS NECESARIAS PARA SUBSTITUIR EL COLECTOR-CODO PARA V6

NEEDS PARTS TO REPLACE V6 MANIFOLD-ELBOW

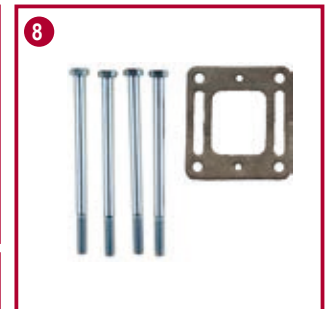
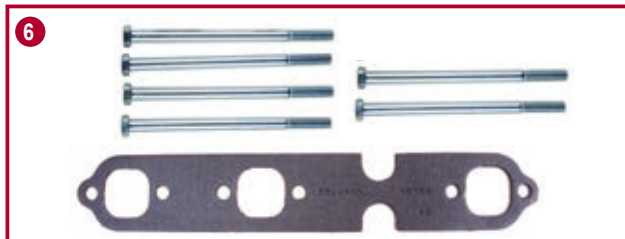

	REF	OEM		UN.	
1	MAR988	807988A03	CODO 4"	ELBOW 4"	2
2	REC32-44348001	32-44348001	FUELLE ESCAPE SUPERIOR	UPPER EXHAUST BELLOW	2
3	REC32-14358001	32-14358001	FUELLE ESCAPE INFERIOR	LOWER EXHAUST BELLOW	2
4	MAR746	99746A17	COLECTOR	MANIFOLD	2
5	REC862210A01	22-862210A01	KIT TAPÓN Y CONDUCTO	HOSE FITTING W/ DRAIN PLUG KIT	2
6	REC32175		KIT JUNTA Y TORNILLOS	GASKETS & BOLTS KIT	2
7	REC27-99757	27-99757	JUNTA COLECTOR (X1)	MANIFOLD'S GASKET (X1)	2
8	REC53400		KIT JUNTAS CODOS Y TORNILLOS	BOLTS & ELBOWS GASKETS KITS	2

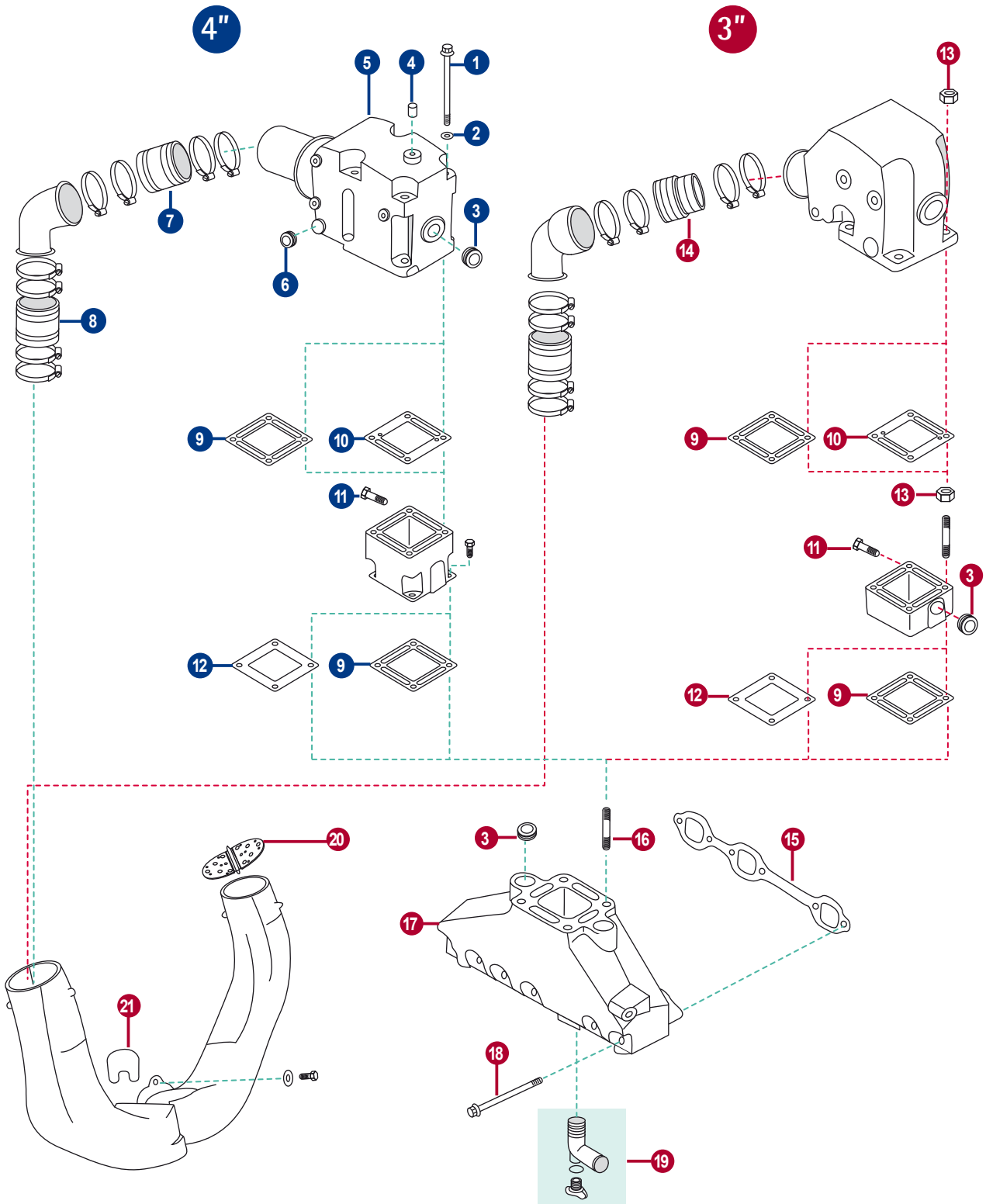

	REF	OEM			UN.
1	REC10-43749	10-43749	TORNILLO	SCREW	4
2	REC13-35048	13-35048	ARANDELA CIERRE	LOCKWASHER	4
3	REC22-41622	22-41622	TAPÓN ACERO	PLUG (STEEL)	2
4	REC22-73379	22-73379	TAPÓN	PLUG	1
5	MAR988	807988A03	CODO 4" 7°	ELBOW 4" 7°	1
6	REC22-36382	22-36382	TAPÓN	PLUG	1
7	REC32-44348001	32-44348001	FUELLE ESCAPE 4"	EXHAUST BELLOW 4"	1
8	REC32-14358001	32-14358001	FUELLE ESCAPE	EXHAUST BELLOW	1
9	REC27-863726	27-863726	JUNTA	GASKET MANIFOLD	1
10	REC27-863724Q	27-863724Q	JUNTA COLECTOR REESTRICTOR	GASKET MANIFOLD FOR RAW WATER	1
11	REC22-328022	22-328022	TAPÓN	PLUG	1
12	REC27-8637251	27-8637251	JUNTA COLECTOR CIRCUITO AGUA DULCE	GASKET MANIFOLD FOR FRESH WATER COOLING	1
13	REC46335	46335	TUERCA CODO	NUT FLANGE SERRATED NUT	4
14	REC70981A3	70981A3	FUELLE ESCAPE 3"	EXHAUST BELLOW 3"	1
15	REC27-99757	27-99757	JUNTA COLECTOR	GASKET EXHAUST MANIFOLD	1
16	REC16-49545	16-49545	ESPARRAGO DE ACERO	STUD (STEEL)	4
17	MAR746	99746A17	COLECTOR	MANIFOLD	1
18	REC10-53728	10-53728	TORNILLO	SCREW	6
19	REC862210A01	22-862210A01	KIT TAPÓN Y CONDUCTO	HOSE FITTING WITH DRAIN PLUG KIT	1
20	REC807166A1	807166A1	PALOMILLA ESCAPE	WATER SHUTTER	1
21	REC41802	41802	JUNTA	GASKET	1
22	HOT20952-MK		KIT MONTAJE PARA	MOUNTING KIT ELBOW HOT20952	
23	HOT28503-MK		KIT MONTAJE PARA HOT20970	MOUNTING KIT ELBOW HOT20970	
24	HOT20976-MK		KIT MONTAJE PARA HOT20976	MOUNTING KIT ELBOW HOT20976	
25	REC32175		KIT TORNILLOS Y JUNTAS COLECTOR V6	EXHAUST MANIFOLD MOUNTING KIT	
26	REC53400		KIT TORNILLOS CODO Y JUNTA	EXHAUST ELBOW MOUNTAING KIT	
27	MAR3320PAR	93320A13	KIT ELEVADOR 76 mm	3" RISER KIT	

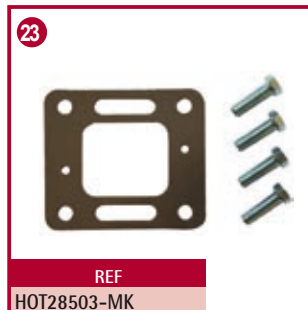

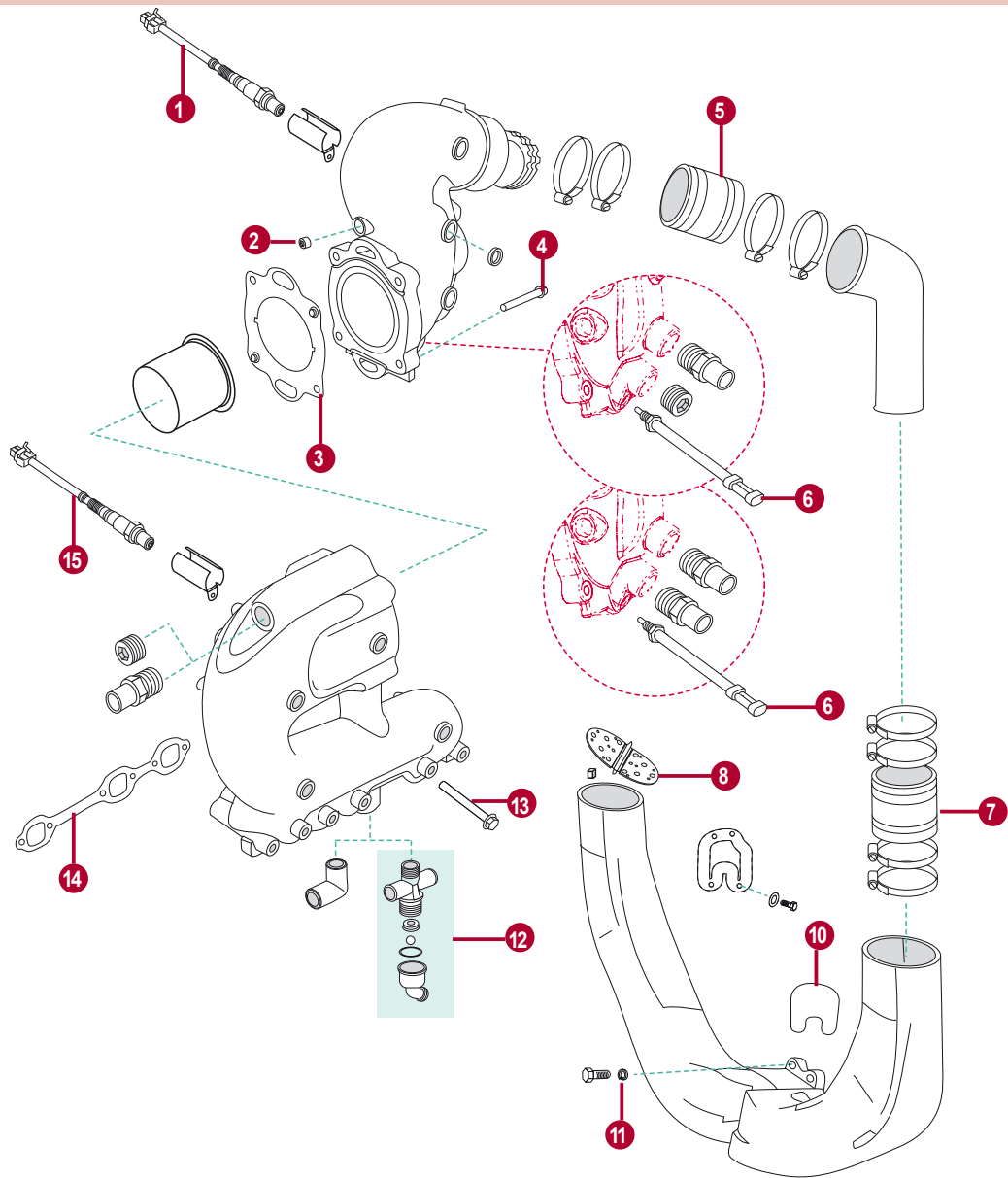

	REF	OEM			UN.
1	REC8M2003959	8M2003959	SENSOR OXÍGENO	OXYGEN SENSOR	2
2	REC22-73379	73379	TAPÓN	PLUG	2
3	REC8M2004414	8M2004414	JUNTA (STANDARD COOLING)	GASKET	2
4	REC10-668631	668631	TORNILLO	SCREW	4
5	REC32-44348001	44348001	TUBO ESCAPE	EXHAUST TUBE	2
6	REC8M0148668	885342002	SENSOR	SENDER	2
7	REC32-14358001	14358001	TUBO ESCAPE	EXHAUST TUBE	2
8	REC807166A1	807166A1	PALOMILLA	SHUTTER ASSY WATER	2
10	REC41802	41802 8M0068607	JUNTA	GASKET	1
11	PAGB/T93-10	41471	ARANDELA	LOCKWASHER	8
12	REC8M0095953	8M0095953	CONECTOR	FITTING ASSY (STD COOLING)	2
13	REC10-53728	8M2000229	TORNILLO	SCREW	6
14	REC27-99757	99757	JUNTA	GASKET	1
15	REC8M0142695	8M0095468	SENSOR OXÍGENO	OXYGEN SENSOR	2

305, 350, 377, 383, 385, (6.2L)  
MAG MPI HORIZON ALPHA/BRAVO

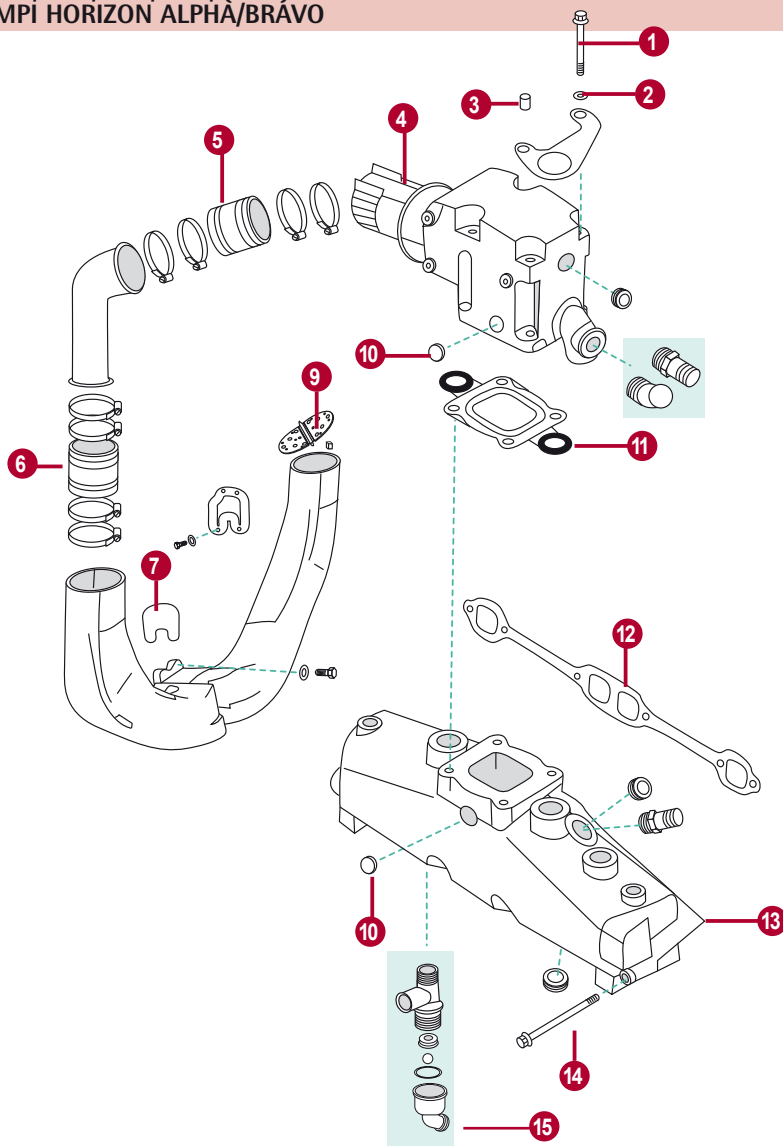

	REF	OEM			UN.
1	REC10-43749	10-43749	TORNILLO	SCREW	8
2	REC13-35048	13-35048	ARANDELA	WASHER	8
3	REC22-73379	22-73379	TAPÓN	PLUG	1
4	MAR309	864309T02	CODO BAJO 17 cm	ELBOW LOW 17 cm	2
	MAR591	864591T02	CODO ALTO 20,5 cm	ELBOW HIGH 20,5 cm	2
5	REC32-44348001	32-44348001	FUELLE ESCAPE	EXHAUST BELLOW	2
6	REC32-14358001	32-14358001	FUELLE ESCAPE COLECTOR	EXHAUST BELLOW	2
7	REC41802	41802	RETÉN TRANSOM	TRANSOM GASKET	1
9	REC807166A1	807166A1	PALOMILLA ESCAPE	WATER SHUTTER	2
10	REC19-864689	19-864689	TAPÓN	PLUG	6
11	REC270	27-864547A02 27-864550A02 27-864549A02	JUNTA CODO - COLECTOR	ELBOW-MANIFOLD GASKET	1
12	REC27-33395	27-33395	JUNTA COLECTOR	MANIFOLD GASKET	2
13	MAR735	865735A02	COLECTOR	MANIFOLD	2
14	REC10-53728	10-53728	TORNILLO	SCREW	8
15	REC22-863786A1	22-863786A1	CONECTOR	FITTING	2
16	RECK309		KIT TORNILLOS CODO Y JUNTA	ELBOW GASKET & BOLT KIT	2
17	REC270	27-864547A02	KIT JUNTA CODO-COLECTOR	ELBOW-MANIFOLD GASKET	2
18	RECK591		KIT PARA MAR591	KIT FOR MAR591	2

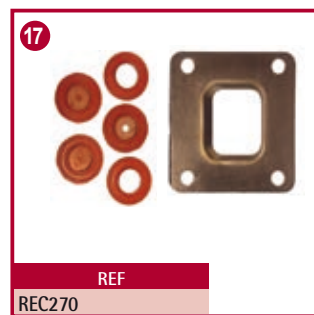

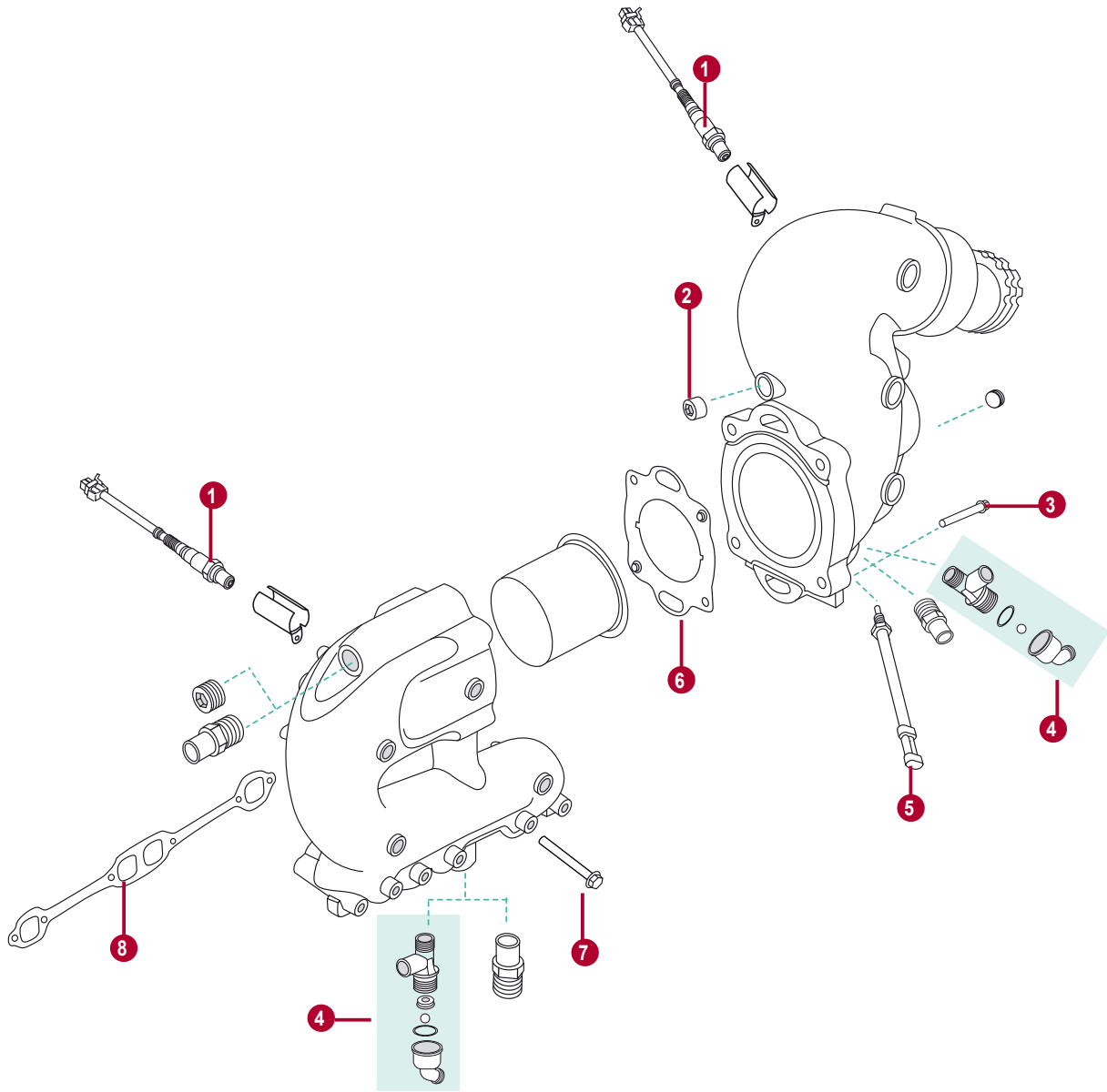

	REF	OEM			UN.
1	REC8M2003959	8M2003959	SENSOR OXÍGENO	O2 SENSOR	4
2	REC22-73379	73379	TAPON	PLUG	
3	REC10-668631	668631	TORNILLO	SCREW	8
4	REC22-863786A1	863786A1	CONECTOR	T FITTING ASSY	2
5	REC8M0148668	885342002	SENSOR	SENSOR ASSY	2
6	REC8M2004414	8M2004414	JUNTA CODO -COLECTOR	GASKET ELBOW-MAIFOLD	2
7	REC10-53728	8M2000229	TORNILLO	SCREW	12
8	REC27-33395	8M2000819	JUNTA COLECTOR ESCAPE	MANIFOLD GASKET	2

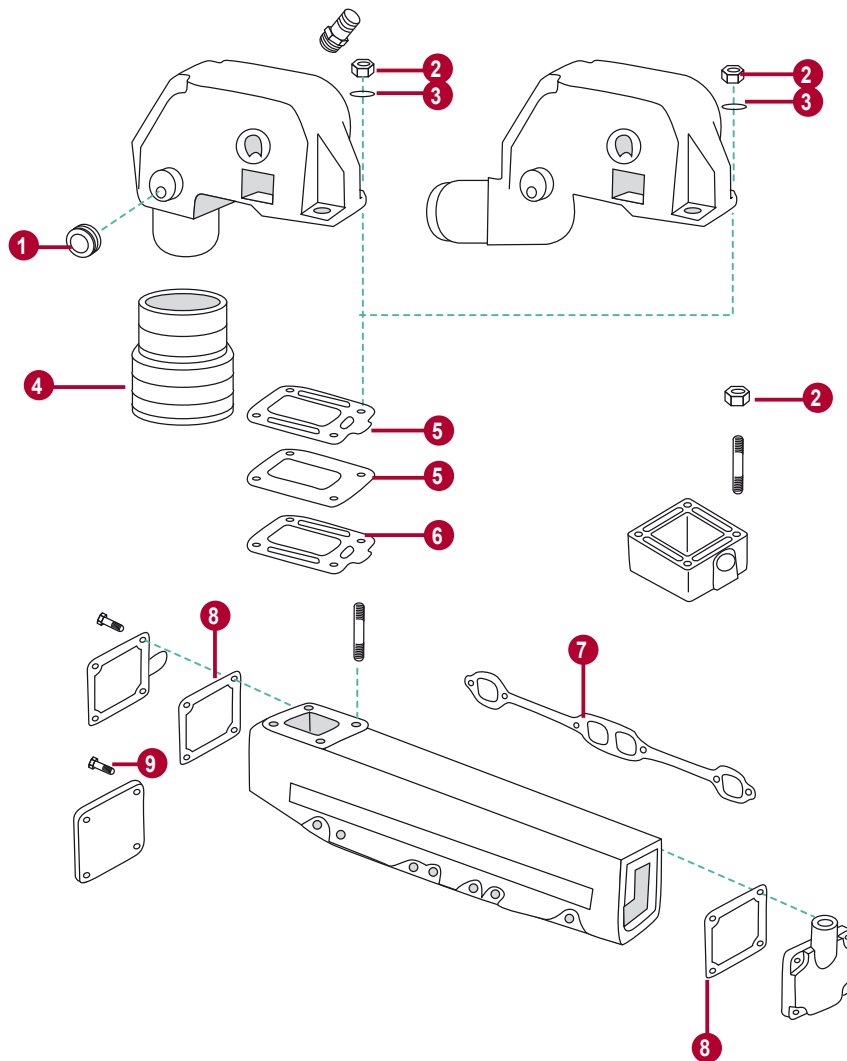

	REF	OEM		UN.	
1	REC22-41622	22-41622	TAPON CODO	ELBOW PLUG	2
2	REC46335	46335	TUERCA CODO	FLANGE SERRATED NUT	4
3	REC13-35048	13-35048	ARANDELA	WASHER	4
4	REC70981A3	70981A3	FUELLE ESCAPE	EXHAUST BELOW	2
5	REC27-99777Q02	27-99777Q02	JUNTA CODO	GASKET EXHAUST ELBOW	2
6	REC16-49545	16-49545	ESPÁRRAGO	STUD	4
7	REC27-33395	27-33395	JUNTA COLECTOR	GASKET EXHAUST MANIFOLD	2
8	REC27-480431	27-480431	JUNTA TAPA	GASKET END CAP	2
9	RM10-25299	10-824941	TORNILLO	SCREW END CAP	4
10	HOT27214-MK		KIT TORNILLOS CODO Y JUNTA	ELBOW GASKET & BOLT KIT	2
11	HOT26371-MK		KIT MONTAJE PARA HOT20971/8	MOUNTING KIT ELBOW HOT20971/8	2

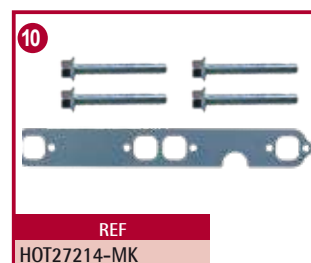

200, 228, 230, 230 MIE, 5.0L, 5.0LX, 898, 5.0L MPI, GM305 CID, 260, 260 MIE, 320 EFI, 350 MAG, GM350 CID, 5.7L, 5.7LX, 6.2L MPI V8 (1983 + 2003)

# MERCURISER

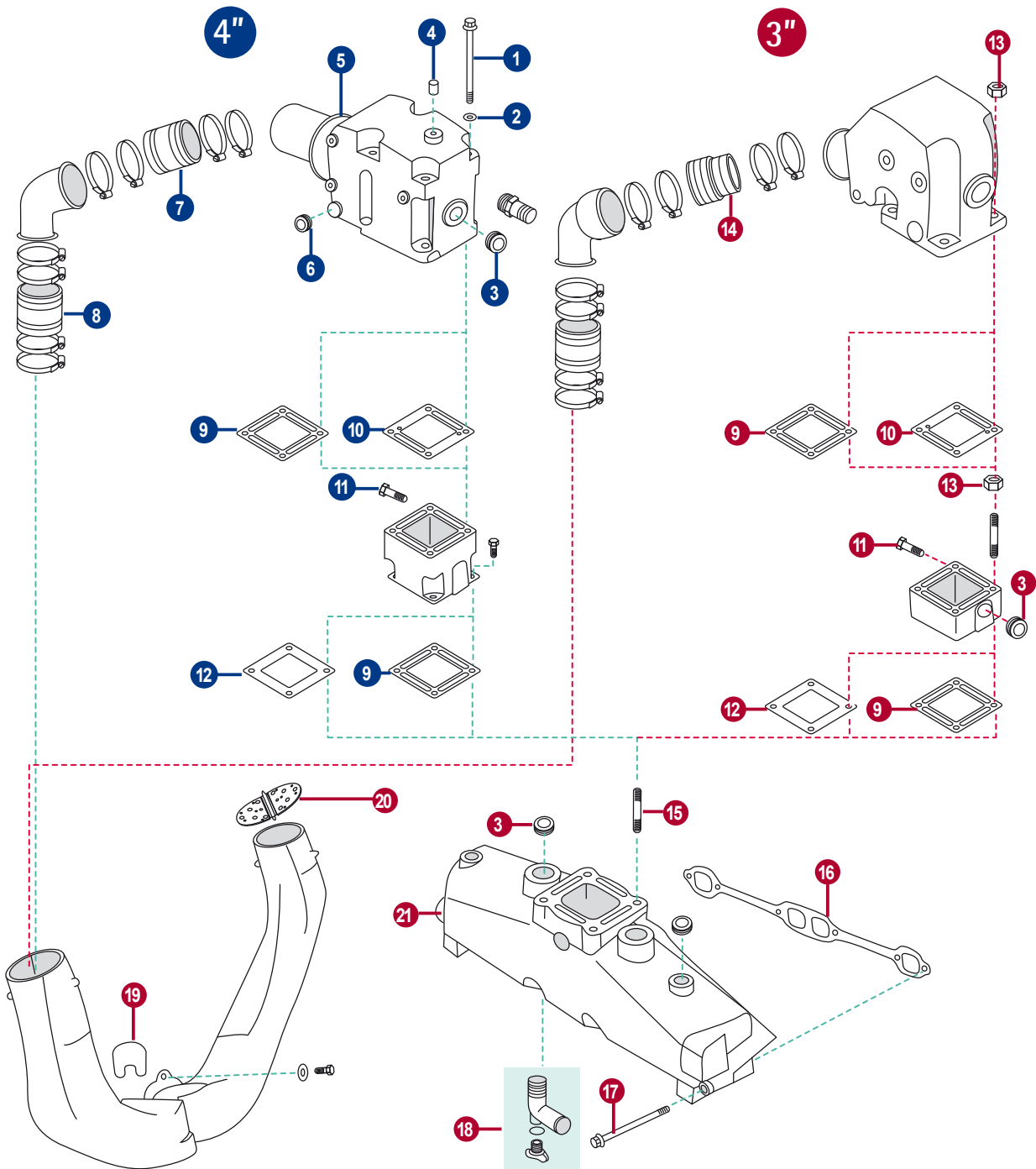

	REF	OEM			UN.
1	REC10-43749	10-43749	TORNILLO ACERO	SCREW STEEL ZINC PLATED	4
2	REC13-35048	13-35048	CIERRE	LOCKWASHER	4
3	REC22-41622	22-41622	TAPÓN ACERO	PLUG (STEEL)	2
4	REC22-73379	22-73379	TAPÓN	PLUG	1
5	MAR988	807988A03	CODO HIERRO	ELBOW (IRON CASTING) 4" 7°	2
6	REC22-36382	22-36382	TAPÓN	PLUG	1
7	REC32-44348001	32-44348001	FUELLE ESCAPE 4"	EXHAUST BELLOW 4"	1
8	REC32-14358001	32-14358001	FUELLE ESCAPE 4"	EXHAUST BELLOW 4"	1
9	REC27-863726	27-863726	JUNTA COLECTOR Y ESPACIADORES	MANIFOLD AND SPACERS	1
10	REC27-863724Q	27-863724Q	JUNTA COLECTOR CIRCUITO CERRADO	GASKET MANIFOLD RAW WATER COOLING	1
11	REC22-328022	22-328022	TAPÓN	CAP	2
12	REC27-8637251	27-8637251	JUNTA COLECTOR CIRCUITO AGUA DULCE	GASKET MANIFOLD FOR FRESH WATER COOLING	1
13	REC46335	46335	TUERCA CODO	FLANGE SERRATED NUT	4
14	REC70981A3	70981A3	FUELLE ESCAPE 3"	EXHAUST BELLOW 3"	1
15	REC16-49545	16-49545	TORNILLO	STUD (STEEL)	1
16	REC27-33395	27-33395	JUNTA COLECTOR	GASKET EXHAUST MANIFOLD	2
17	REC10-53728	10-53728	TORNILLO	SCREW	4
18	REC862210A01	22-862210A01	KIT TAPÓN Y CONDUCTO	HOSE FITTING WITH DRAIN PLUG KIT	1
19	REC41802	41802	RETÉN TRANSOM	TRANSOM GASKET	1
20	REC807166A1	807166A1	PALOMILLA ESCAPE	WATER SHUTTER	2
21	MAR246	860246A15	COLECTOR	MANIFOLD	2
22	HOT28503-MK		KIT MONTAJE PARA HOT20970	MOUNTING KIT HOT20970	2
23	REC53400		KIT TORNILLOS CODO Y JUNTA	EXHAUST ELBOW MOUNTAING KIT	2
24	HOT20976-MK		KIT MONTAJE PARA HOT20976	MOUNTING KIT HOT20976	2
25	HOT27214-MK		KIT PARA MONTAJE PARA HOT20951/1	MOUNTING KIT HOT20951/1	2
26	MAR3320PAR	93320A13	KIT RISER 76 mm	KIT RISER 3"	

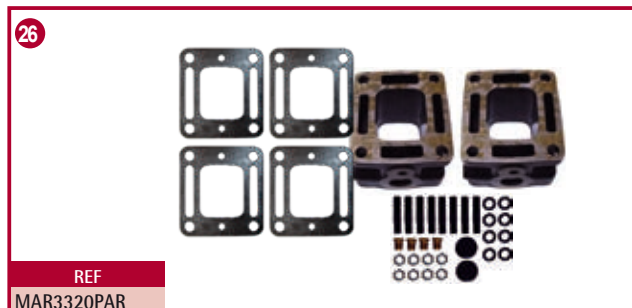
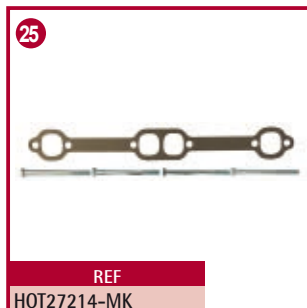
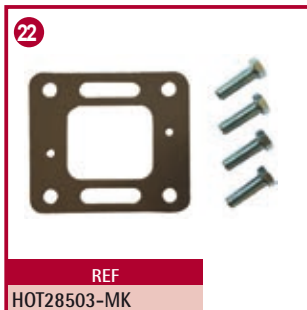

330, 340MIE, 370TRS, 454EFI, 454MAG, 7.4MIE, 7.4L, 7.4LX, GM454 CID V8  
 502 EFI, 502 MAG, 8.2L, GM502 CID V8

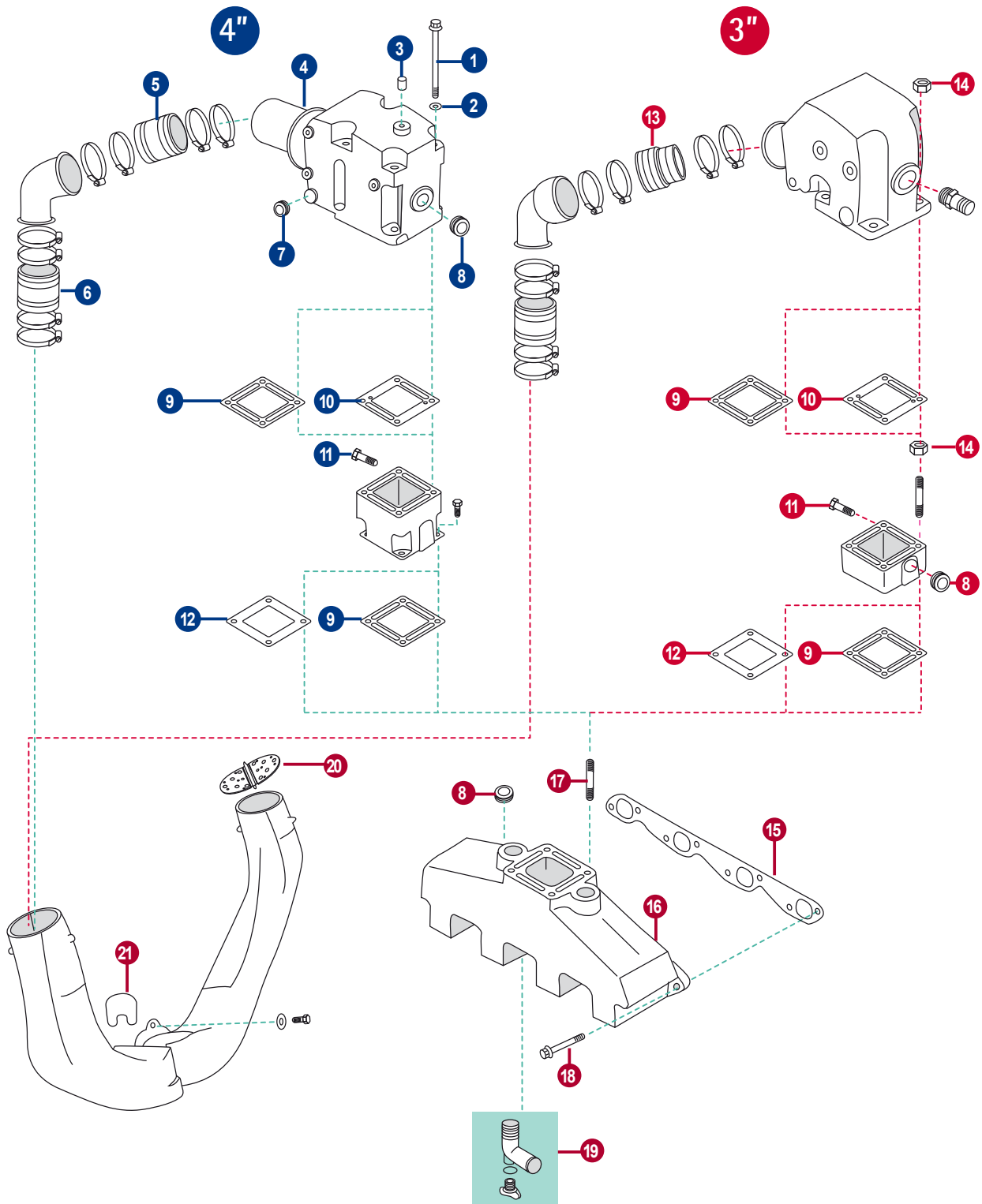

	REF	OEM		UN.	
1	REC10-43749	10-43749	TORNILLO	SCREW STEEL ZINC PLATED	4
2	REC13-35048	13-35048	CIERRE	LOCKWASHER	4
3	REC22-73379	22-73379	TAPÓN	PLUG	1
4	MAR988	807988A03	CODO HIERRO 4" 7°	EXHAUST ELBOW (IRON CASTING) 4", 7°	1
5	REC32-44348001	32-44348001	FUELLE ESCAPE 4"	EXHAUST BELLOW 4"	1
6	REC32-14358001	32-14358001	FUELLE ESCAPE 4"	EXHAUST BELLOW 4"	1
7	REC22-36382	22-36382	TAPÓN	PLUG	2
8	REC22-41622	22-41622	TAPÓN ACERO	PLUG (STEEL)	2
9	REC27-863726	27-863726	JUNTA	GASKET EXHAUST MANIFOLD AND SPACERS	1
10	REC27-863724Q	27-863724Q	JUNTA CODO ESCAPE	EXHAUST ELBOW GASKET	1
11	REC22-328022	22-328022	TAPÓN	PLUG	2
12	REC27-8637251	27-8637251	JUNTA COLECTOR CIRCUITO AGUA DULCE	MANIFOLD FRESH WATER COOLING	1
13	REC70981A3	70981A3	FUELLE ESCAPE 3"	EXHAUST BELLOW 3"	1
14	REC46335	46335	TUERCA	FLANGE SERRATED NUT	4
15	REC27-46820	27-46820	JUNTA COLECTOR	GASKET EXHAUST MANIFOLD	2
16	MAR078	807078T10	COLECTOR HIERRO	EXHAUST MANIFOLD ASSEMBLY (IRON )	2
17	REC16-49545	16-49545	ESPÁRRAGO 3/8" x 13/4"	STUD 3/8" x 13/4"	4
18	REC10-37612	10-37612	TORNILLO	SCREW	8
19	REC862210A01	22-862210A01	KIT TAPÓN Y CONDUCTO	HOSE FITTING WITH DRAIN PLUG KIT	2
20	REC807166A1	807166A1	PALOMILLA DE ESCAPE	WATER SHUTTER	2
21	REC41802	41802	RETÉN TRANSOM	TRANSOM GASKET	1
22	HOT28503-MK		KIT MONTAJE PARA HOT20970	MOUNTING KIT HOT20970	2
23	REC53400		KIT TORNILLOS CODO Y JUNTA	EXHAUST ELBOW MOUNTAING KIT	2
24	HOT20976-MK		KIT MONTAJE PARA HOT20976	MOUNTING KIT HOT20976	2
25	REC33765		KIT TORNILLOS COLECTOR Y JUNTA	EXHAUST MANIFOLD MOUNTING KIT	2
26	MAR3320PAR	93320A13	KIT RISER 76 mm	KIT RISER 3"	1
27	HOT20957-MK		KIT MONTAJE MAR078	MOUNTING KIT ELBOW MAR078	2

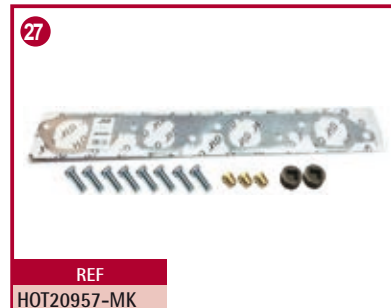
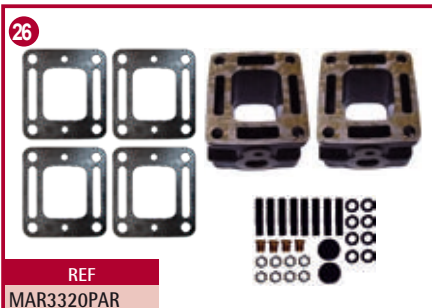
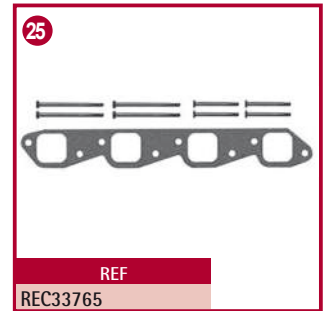
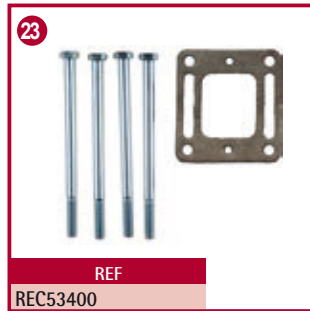
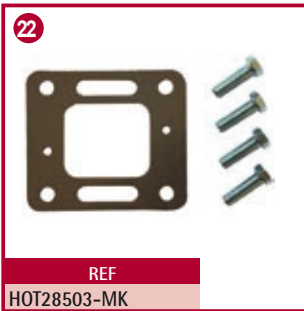

325-325MIE, GM427 CID V8  
 330-330MIE 370TRS - 400TRS - 440TRS - GM454 CID  
 390 - 390MIE - 460TRS, GM472 CID V8  
 225 - 225MIE - 250 - 250MIE - GM327CID - 228 - 228MIE  
 GM305CID - 250 - 270 - 270MIE - 280TRS - GM350 CID V8

REF	OEM		
1	REC22-41622 22-41622	TAPÓN CODO	ELBOW PLUG
2	REC46335 11-46335	TUERCA CODO	NUT
3	REC13-35048 13-35048	ARANDELA	WASHER
4	REC22-328022 22-328022	TAPÓN	CAP
5	REC27-48042 27-48042	JUNTA	GASKET
6	REC27-480431 27-480431	JUNTA	GASKET
7	REC16-49545 16-49545	TORNILLO CODO COLECTOR	STUD MANIFOLD
8	REC10-37612 10-37612	TORNILLO 11/4"	SCREW 11/4"
	REC27-46820 27-46820	KIT JUNTAS COLECTOR	GASKET EXHAUST MANIFOLD
9	REC27-33395 27-33395	KIT JUNTAS COLECTOR (225 - 228 - 250 - 270 - 280 - 305 - 327 - 350)	GASKET EXHAUST MANIFOLD (225 - 228 - 250 - 270 - 280 - 305 - 327 - 350)

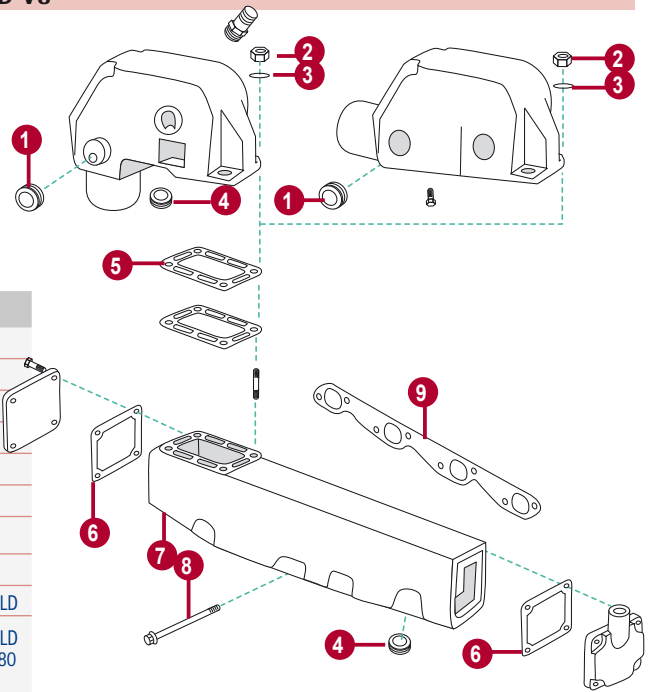

215, 225, 225MIE, 888 FORD 302 V8 233, 233MIE, 255, 255MIE, FORD 351 V8

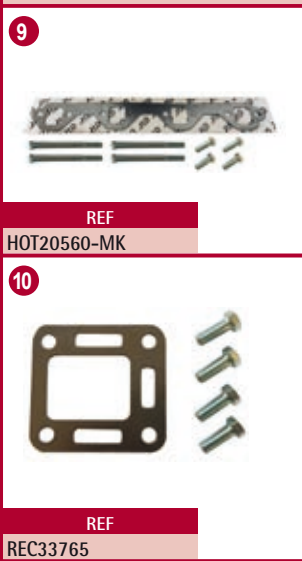

REF  
HOT20560-MK



REF  
REC33765

REF	OEM		
1	REC46335 11-46335	TUERCA CODO	NUT
2	REC13-35048 13-35048	ARANDELA	WASHER
3	REC22-328022 22-328022	TAPÓN	CAP
4	REC27-99777Q02 27-99777Q02	JUNTA	GASKET
5	REC27-480431 27-40431	JUNTA	GASKET
6	REC16-49545 16-49545	TORNILLO CODO COLECTOR	STUD MANIFOLD
7	REC3852455 27-73866	JUNTA COLECTOR ESCAPE	MANIFOLD GASKET
8	REC10-37612 10-37612	TORNILLO 11/4"	SCREW 11/4"
9	HOT20560-MK	KIT MONTAJE PARA HOT20962/58	MOUNTING KIT ELBOW HOT20962/58
10	HOT26371-MK	KIT MONTAJE PARA HOT20978/71	MOUNTING KIT ELBOW HOT20978/71

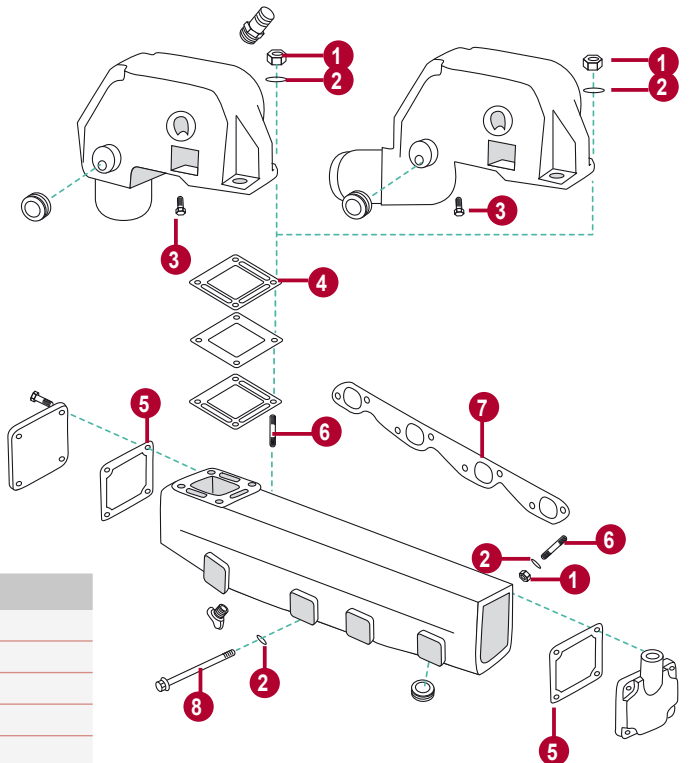

**120HP GM 153  
4CYL**

**JUNTA COLECTOR**

**MANIFOLD GASKET**

REF	OEM
REC27-52546	27-52546



**JUNTA CODO ESCAPE**

**ELBOW MANIFOLD  
GASKET**

REF	OEM
REC27-39915	27-39915



**COLECTORES**

**MANIFOLDS**

REF	OEM	
MAR746	99746A8	GM 4.3L Et 3.8L V6
	99746A17	175, 185, 205, 229 Et 262
	99746A3	(1985-02)



KIT MAR746



REF	OEM	
MAR612	864612T01	GM4.3L MPI OM615000+ (2002+) 262



REF	OEM	
MAR735	865735A02	50L, 5.7L, 6.2L (V8)
	864308T01	305, 350, 377
	865049T01	(2002+)



KIT MAR735



REF	OEM	
MAR246	860246A15	305, 350 Et 377 V8GM (1983-02)
	87114A19	
	860246A3	
	860246A9	
	860246A10	



REF	OEM	
MAR078	807078T10	GM V8 BIG BLOCK 330, 340, 370 (454) 7.4L 502 8.2L
	807078T09	
	807078A6	
	89011A8	



REF	OEM	
MAR966	860235A03	3.0L Et 3.0LX, GM 181 4 CYL (1990+)



TAPA COLECTORES

MANIFOLD COVER

REF	OEM
REC3852476	878990



CODOS

ELBOW

CODO

ELBOW

REF	OEM	
MAR076	12076A2	GM 2.5L, 3.0 & 3.0LX (1982+) NEW MODEL



REF	OEM	
MAR309	864309T02 864309T01	GM V6 & V8 262, 305, 350, 377, 383 MPI (2002+) 7° (4" O.D. RISER)

CODO BAJO  
LOW ELBOW



REF	OEM	
MAR988	807988A03 807988A2 807914A1 44354A3	GM V6 & V8 SMALL & BIG BLOCK (1983-02) 7° (4" O.D. RISER)



REF	OEM	
MAR591	864591T02	GM V6 & V8 262, 305, 350, 377, 385, 6.2L MPI (2002+) 7° (4" O.D. RISER)

CODO ALTO  
HIGH ELBOW



REF	OEM	
MAR988INOX	807988A03 807988A2 807914A1 44354A3	GM V6 & V8 SMALL & BIG BLOCK (1983-02) 7° (4" O.D. RISER)



## KIT RISER 3" / 76mm

REF	OEM	COLECTORES MANIFOLDS	
MAR3320PAR	93320A13 807476A6 93320A5	MAR746 MAR246 MAR078 (-2002)	305, 350, 262, 454, 502 (5.0, 5.7, 4.3, 7.4, 8.2) MCM V6 & TBI (2 colectores escape   2 exhaust manifold  ) (-OM614999) MCM/MIE/SKI V8 (305, 350, 377, 354 & 502 CID) (Codo de hierro   cast iron elbow  ) (-OM299999) MCM V8 (305 & 350 CID) Carb. (OM300000-OM599999) MIE & SKI Carb. (OM300000-OM316999)

REF	OEM	COLECTORES MANIFOLDS	
MAR929	864929A3	MAR612	350, 357, 377, 383, 385 (MAG, MPI) GM V6&V8 (4.3, 5.0, 5.7, 6.2) (2002+)

## JUNTAS COLECTOR-CODO

## MANIFOLD-ELBOW GASKET

REF	OEM
REC27-39915	27-39915

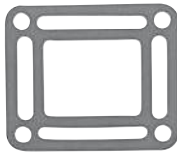

REF	OEM
REC27-99777Q02	27-99777Q02 27-997771 27-997772



REF	OEM
REC27-18272	27-18272



REF	OEM
REC27-856705	27-856705 27-97542

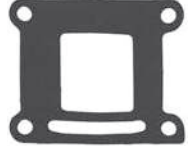

REF	OEM	CODOS ELBOWS
REC27-8637251	27-8637251 860231 863725	MAR988



REF	OEM
REC27-48042	27-48042

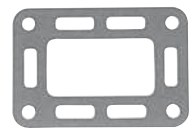

REF	OEM	CODOS ELBOWS
REC27-863724Q	27-863724Q 27-41813 27-860233 27-863724	MAR988



REF	OEM	CODOS ELBOWS
REC270	27-864547A02 27-864550A02 27-864549A02	MAR309 MAR591



REF	OEM	CODOS ELBOWS
REC27-863726	27-863726 27-871051 27-818832 27-860232	MAR988



REF	OEM	CODOS ELBOWS
REC8M2004414	8M2004414	STANDARD COOLING V6 & V8 NEW MODELS



REF	OEM
RM27-864549A02	27-864549A02

**1 CLOSED COOLING**



REF	OEM
REC27-864547A02	27-864547A02

**2 OPEN COOLING**



REF	OEM
REC27-864850A02	27-864850A02

**3 RESTRICTOR COOLING**

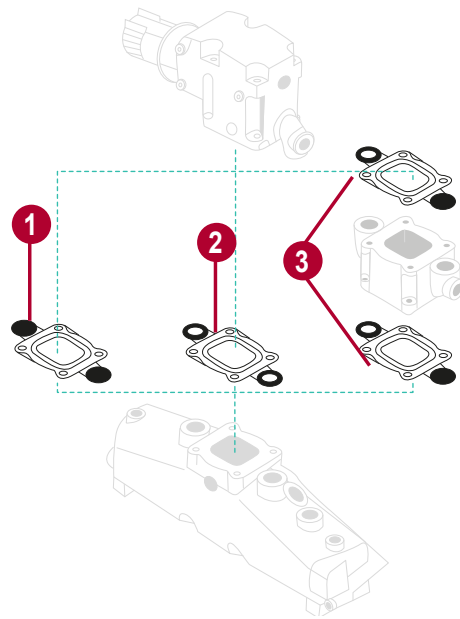

**TAPONES**

**CAPS**

REF	ROSCA
REC22-328022	1/8 - 27 NPT
REC22-36382	1/4 - 18 NPT
REC22-41622	3/4 - 14 NPT
REC13980	
REC22-73379	.250-18



REC22-328022

REC22-36382

REC22-41622

REC22-73379

REC13980

**JUNTAS TAPAS LATERALES**

**SIDE GASKET CAPS**

REF	OEM
REC27-807218	27-807218



REF	OEM
REC27-480431	27-480431



**PALOMILLAS DE ESCAPE**

**WATER SHUTTER**

REF	OEM	Ø	Icon
REC99370A2	99370A2	3" (76 mm)	



REF	OEM	Ø	Icon	Icon
REC807166A3	807166A3 14348A1	4" (101 mm)		



REF	OEM	Ø	Icon
REC807166A1	807166A1	4" (101 mm)	

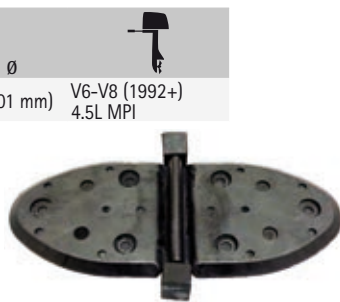

REF	OEM	Icon
REC60930	60930	



**JUNTAS  
COLECTOR-CULATA**

REF	OEM	
REC27-68715	27-68715	MCM 3.7L (4 cyl)



REF	OEM	
REC27-52546	27-52546	GM 153 (4 cyl)



REF	OEM	
REC27-53354	27-53354	GM 181 (4 cyl)



REF	OEM	COLECTORES MANIFOLDS	
REC27-46820	27-46820	MAR078	GM V8 BIG BLOCK



REF	OEM	
REC3852455	27-73866	FORD V8 (302, 351)



**MANIFOLD-HEAD  
GASKET**

REF	OEM	
REC27-815528	27-815528	GM 181 (4 cyl)



REF	OEM	COLECTORES MANIFOLDS	
REC27-99757	27-99757	MAR746 MAR612	GM V6



REF	OEM	
REC27-96429	27-96429	GM 153 & 181 (4 cyl)



REF	OEM	COLECTORES MANIFOLDS	
REC27-33395	27-33395	MAR246	GM V8 SMALL BLOCK



**PROTECTORES SALIDA DE ESCAPE**

**EXHAUST PROTECTOR VALVES**

REF	OEM	
REC12644A1	12644A1	101 mm = 4"



**FUELLES DE ESCAPE**

**EXHAUST BELLOW**

REF	OEM	Ø IN.
REC32-14358001	32-14358001	4" (101 mm)
	32-14358T	Tube inferior
	32-14358	Lower tubo



REF	OEM	Ø IN.
REC32-44348001	32-44348001	4" (101 mm)
	32-44348T	Tube superior
	32-44348	Upper tubo



REF	OEM	Ø IN.
REC70981A3	70981A3	3" - 4" (76 - 101 mm)



# UNIDADES DE TRANSMISION

# TRANSMISSION UNIT

## DESPIECE COLAS

## GEAR CASE PARTS

R / MR / ALPHA ONE  
(6225577 - OD469858)

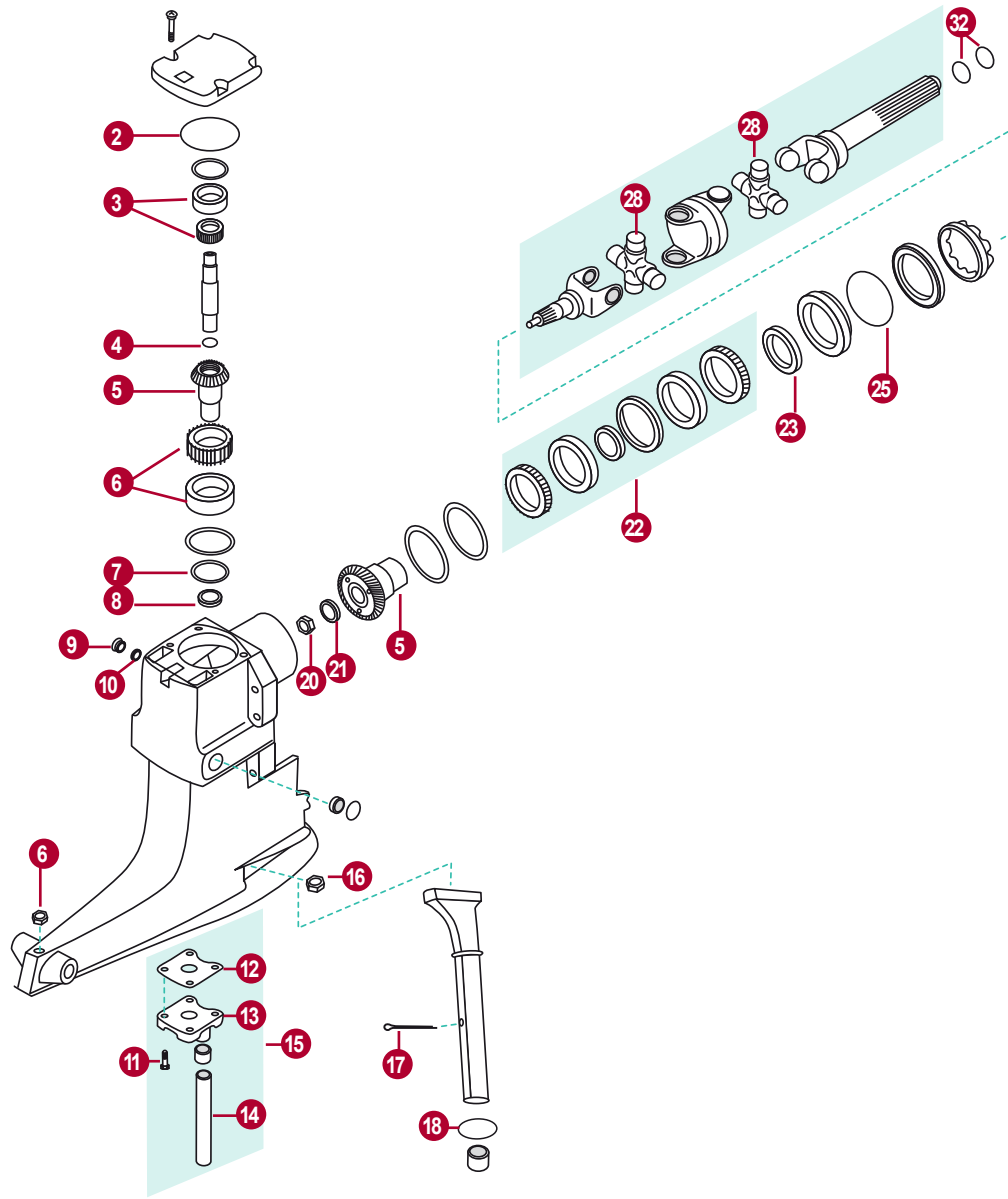

Abrazadera U de acoplamiento (39385A1) en modelos en línea.

U-joint coupling end yoke (39385A1) used on older in-line models.

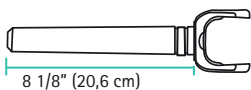

**USO DE MODELOS ANTIGUOS DE COLAS EN MODELOS MERCURUISER IR-IMR**  
Mercury Marine no recomienda el uso de colas de modelos antiguos en modelos IR-IMR, ya que estas unidades no se acoplarán satisfactoriamente con el ensamblaje del transom. Además, las unidades en serie del modelo anterior, están equipadas con una horquilla de acoplamiento de unión en U (39385A1). Este eje es más corto que el (59830A1) usado en las unidades de impulsión de popa IR-IMR, y por lo tanto no acoplará completamente las estrías del motor. El uso del modelo más antiguo en un modelo de IR-IMR llevará al fallo de spline para acoplar al eje.

**USE OF OLDER MODEL STERN DRIVE UNITS ON MERCURUISER IR-IMR MODELS**  
Mercury Marine does not recommend the use of older model stern drive units on IR-IMR models, as these units will not mate up satisfactorily with the transom assembly. In addition, the older model in-line stern drive units are equipped with U-joint coupling end yoke (39385A1). This yoke is shorter than yoke (59830A1) used on the IR-IMR stern drive units, and therefore will not fully engage the engine coupler splines. Use of an older in-line model stern drive unit on a IR-IMR model will result in a spline failure to coupling an/or yoke.

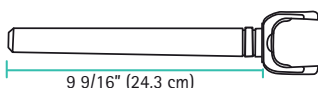

	REF	OEM		
2	REC25-32546	25-32546	ARO TÓRICO	O-RING
3	REC31-61100A1	31-61100A1	COJINETE Ø EXT. 49 mm	BEARING ASSY EXT. Ø 49 mm
	REC31-32575T1	31-32575T1	COJINETE Ø EXT. 45 mm	BEARING ASSY EXT.L Ø 45 mm
4	REC25-55801	25-55801	ARO TÓRICO	O-RING
5	REC43-75325A3	43-75325A3	KIT PIÑONES H.D. (Red.1.84) (17-19)	GEAR SET HD (1.84) (17-19)
6	REC19-47579		TAPÓN TORNILLO TIMÓN	
7	REC26-32511	26-32511	RETÉN	OIL SEAL
8	REC26-965031	26-965031	RETÉN	OIL SEAL
9	REC10-79953Q04	10-79953Q04	TAPÓN ACEITE	SCREW
10	REC12-191833	12-191833	JUNTA TAPÓN	WASHER
11	REC10-28668	10-28668	TORNILLO	SCREW
12	REC27-558101	27-55810 1	JUNTA	GASKET
13	REC26-36557	26-36557	CASQUILLO GOMA	GROMMET
14	REC32-54236	32-54236	TUBO DE GOMA	WATER TUBE
15	REC42724A3	42724A3	KIT REFRIGERACIÓN	WATER POCKET COVER KIT
16	REC11-34933	11-859116	TUERCA	NUT
17	REC18-32665	18-32665	PASADOR	PIN
18	REC12-32666	12-32666	ARANDELA	WASHER
20	REC11-22339	11-22339	TUERCA	NUT
21	REC12-45810	12-45810	ARANDELA TOPE	WASHER
22	REC31-35988A12	31-35988A12	RODAMIENTO (excepto 1.32)	ROLLER BEARING (except 1.32)
23	REC26-823894	26-823894	RETÉN	OIL SEAL
25	REC25-70937	25-70937	ARO TÓRICO	O-RING
	REC3850812	75832T1	CRUCETA CARDÁN	U-JOINT
28	REC75832T	75832T	CRUCETA CARDÁN (4 en línea y V6)	U-JOINT (4 inline & V6)
	REC805536A2	805536A2	CRUCETA AUTOENGRASE	U-JOINT SELF GREASE
32	REC25-25439	25-25439	ARO TÓRICO	O-RING
33	REC27-64818Q4	26-64818Q4 27-64718A1	KIT DE JUNTAS	GASKET KIT
34	REC26-32511A1	26-32511A1	KIT DE JUNTAS	GASKET KIT
35	RECKITMALPHA1AL		KIT ÁNODOS ALUMINIO	ANODES KIT AL



21

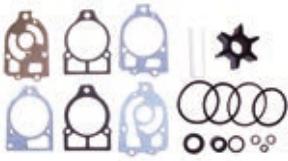

REF

REC47-89984Q5

22



REF

REC26-33144A2

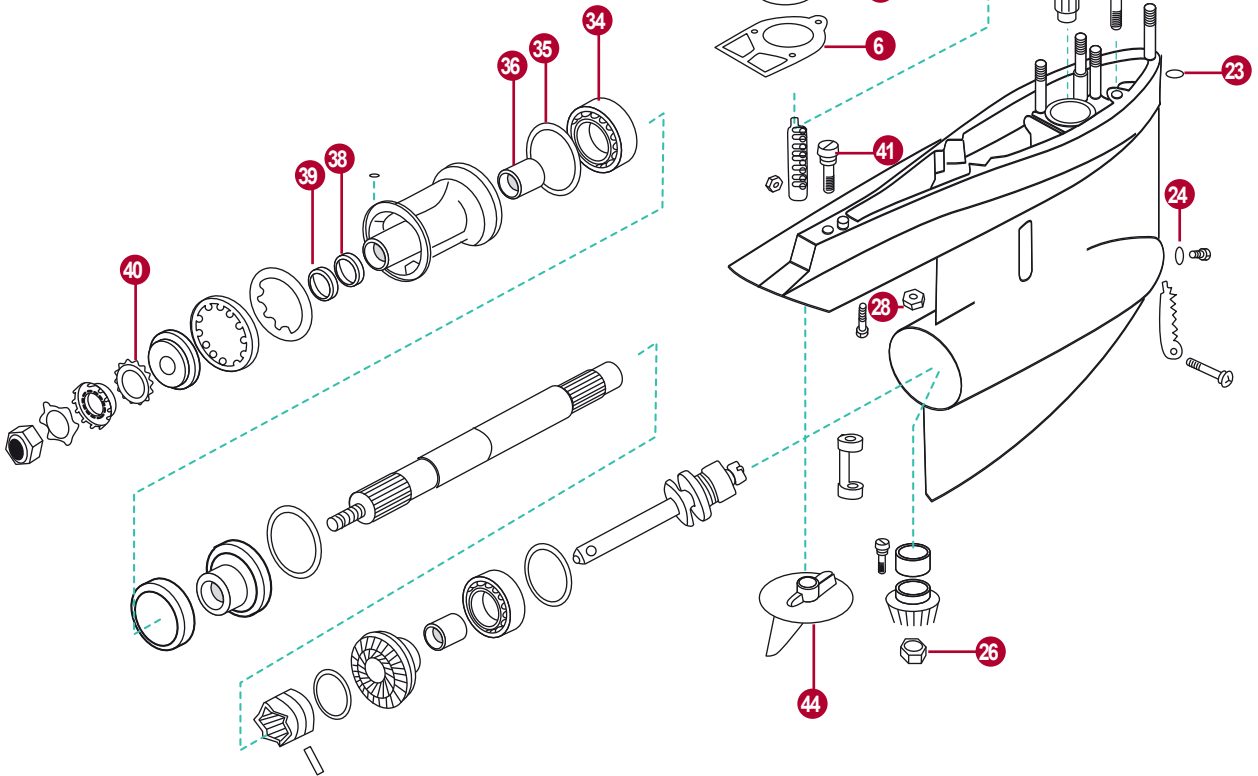

	REF	OEM		
3	REC25-25439	25-25439	ARO TÓRICO	O-RING
4	REC23-30617A2	23-30617A2	ACOPLE EJE	ATTACHING SHAFT
5	REC26-8164641	26-8164641	RETÉN	SEAL
6	REC27-856704	27-856704	JUNTA	GASKET
7	REC25-33145	25-33145	ARO TÓRICO	O-RING
8	REC26-89238	26-89238	RETÉN	SEAL
9	REC26-16977	26-16977	RETÉN	SEAL
10	REC27-856081	27-856081	JUNTA BOMBA	PUMP GASKET
11	REC27-858524	27-858524	JUNTA TAPA BOMBA	COVER GASKET
12	REC47-89984T4	47-89984T4	IMPULSOR	IMPELLER
13	REC48752T	48752T	CASQUILLO BOMBA	INSERT
14	REC46-96148T1	46-96148T1	CUERPO BOMBA AGUA	HOUSING WATER PUMP
16	REC25-30613	25-30613	ANILLO GOMA	RUBBER RING
17	REC23-29804T	23-29804T	TUBO GUÍA	WATER PIPE
18	REC26-38970	26-38970	RETÉN	OIL SEAL
21	REC47-89984Q5	47-89984Q5	KIT REPARACIÓN	SEAL KIT
22	REC26-33144A2	26-33144A2	KIT REPARACIÓN	SEAL KIT
23	REC26-455771	26-455771	RETÉN	SEAL
24	REC12-191833	12-191833	JUNTA	GASKET
28	REC11-34933	11-859116	TUERCA	NUT
34	REC30-88957T	30-88957T	RODAMIENTO	BEARING
35	REC25-31534	25-31534	ARO TÓRICO	O-RING
36	REC387247	31-30956T	RODAMIENTO	BEARING
38	REC26-76868	26-76868	RETÉN INTERIOR	INNER SEAL
39	REC26-12224	26-12224	RETÉN EXTERIOR	OUTLER SEAL
40	REC13-423511	13-42351-1	ARANDELA CIERRE	WASHER CAP
41	REC10-32470	10-32470	TORNILLO	SCREW
42	REC11-52707Q1	11-52707Q1	KIT CIERRE HÉLICE	PROPELLER NUT KIT
43	RECKITMALPHA1AL	888756Q04	KIT ÁNODOS AL	ANODE KIT AL
44	REC31640Q4AL	31640Q4	ANODO	ANODE





REF

REC12120



REF

REC47-89984Q5



REF

REC26-33144A2

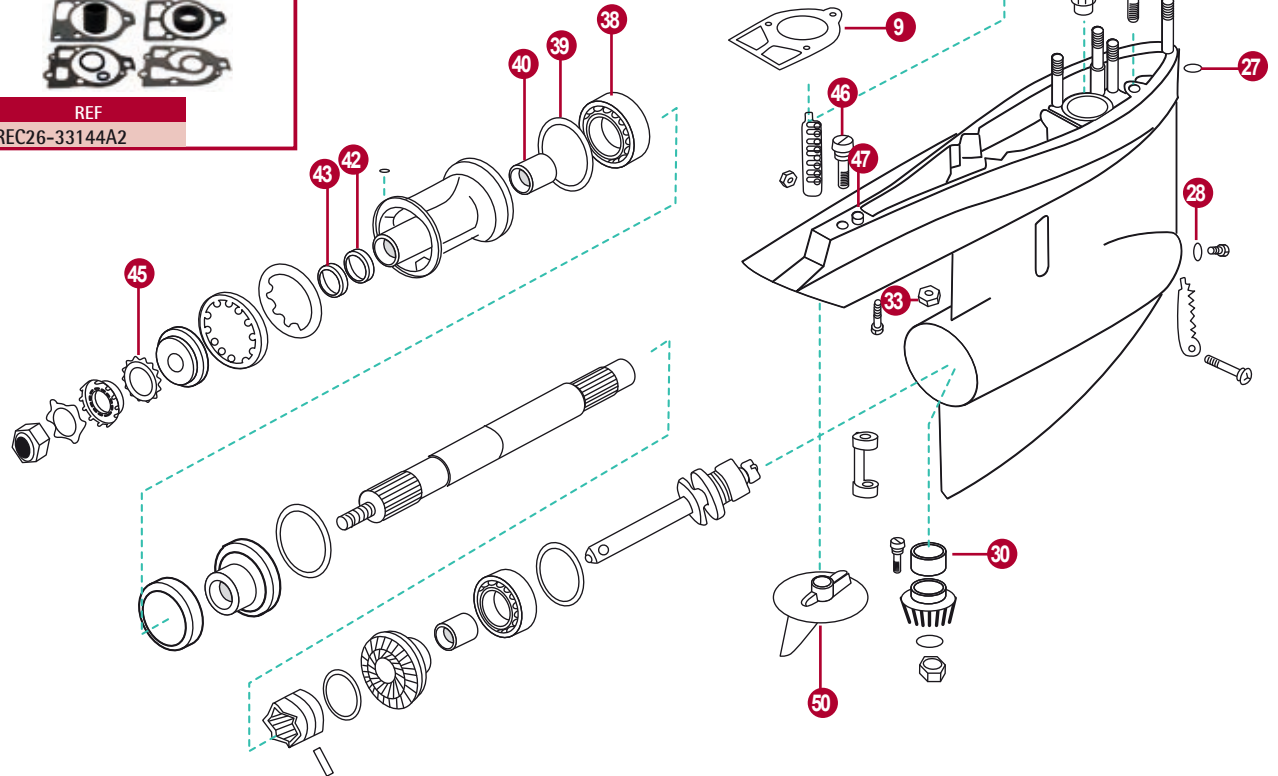

	REF	OEM		
3	REC53-29641	53-29641	CLIP	LOCKER
4	REC25-25439	25-25439	ARO TÓRICO	O-RING
5	REC23-30617A2	23-30617A2	ACOPLE EJE	ATTACHING SHAFT
6	REC26-8164641	26-8164641	RETÉN	SEAL
9	REC27-426311	27-42631-1	JUNTA	GASKET
10	REC25-90011	25-90011	ARO TÓRICO (Ø 2.188")	O-RING (Ø 2.188")
11	REC26-89238	26-89238	RETÉN	SEAL
12	REC26-16977	26-16977	RETÉN	SEAL
13	REC46-44292Q03	46-44292Q03	BASE BOMBA	PUMP BASE
14	REC27-856081	27-856081	JUNTA BOMBA	PUMP GASKET
15	REC27-858524	27-858524	JUNTA TAPA BOMBA	COVER GASKET
16	REC47-89984T4	47-89984T4	IMPULSOR	IMPELLER
17	REC48752T	48752T	CASQUILLO BOMBA	INSERT
18	REC46-96148T1	46-96148T1	CUERPO BOMBA AGUA	HOUSING WATER PUMP
20	REC25-30613	25-30613	ARO TÓRICO	O-RING
21	REC23-29804T	23-29804T	TUBO GUÍA	WATER PIPE
22	REC26-38970	26-38970	RETÉN	SEAL
24	REC12120	46-96148A8	KIT REPARACIÓN	SEAL KIT
25	REC47-89984Q5	47-89984Q5	KIT REPARACIÓN	SEAL KIT
26	REC26-33144A2	26-33144A2	KIT REPARACIÓN	SEAL KIT
27	REC26-455771	26-45577 1	RETÉN	SEAL
28	REC12-191833	12-191833	JUNTA	GASKET
30	REC387817	31-42647A1	RODAMIENTO	BEARING
33	REC11-34933	11-859116	TUERCA	NUT
38	REC30-88957T	30-88957T	RODAMIENTO	BEARING
39	REC25-31534	25-31534	ARO TÓRICO	O-RING
40	REC387247	31-30956T	RODAMIENTO	BEARING
42	REC26-76868	26-76868	RETÉN INTERIOR	INNER SEAL
43	REC26-12224	26-12224	RETÉN EXTERIOR	OUTLER SEAL
45	REC13-423511	13-423511	ARANDELA CIERRE	WASHER
46	REC10-32470	10-32470	TORNILLO	SCREW
47	REC331880	17-35973	PASADOR	PIN
48	REC11-52707Q1	11-52707Q1	KIT CIERRE HÉLICE	PROPELLER NUT KIT
49	RECKITMALPHA1AL	888756Q04	KIT ÁNODOS AL	ANODE KIT AL
50	REC31640Q4AL	31640Q4	ANODO	ANODE



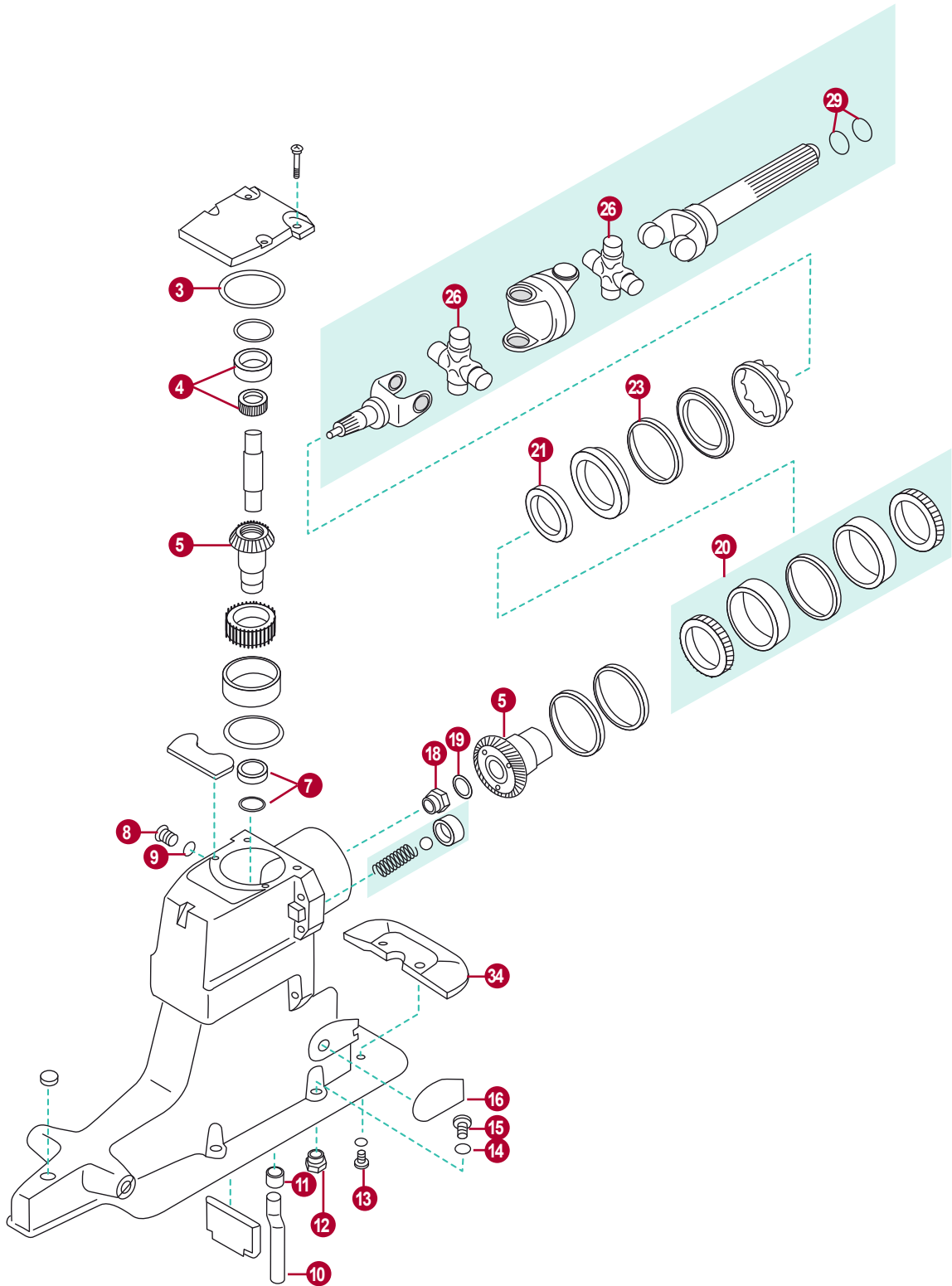

	REF	OEM		
3	REC25-32546	25-32546	ARO TÓRICO	O-RING
	REC31-61100A1	31-61100A1	RODAMIENTO Ø EXT.49 mm (1991-95)	BEARING Ø EXT. 49 mm (1991-95)
4	REC31-32575T1	31-32575T1	RODAMIENTO Ø EXT.45 mm (-1996)	BEARING Ø EXT. 45 mm (-1996)
5	REC43-75325A3	43-75325A3	KIT PIÑONES (Red 1.84/1.81) (17-19) 1991-97	PINION KIT (Ratio 1.84/1.81) (17-19) 1991-97
7	REC26-66302	26-66302	RETÉN	SEAL
8	REC10-79953Q04	10-79953Q04	TORNILLO COLA	SCREW
9	REC12-191833	12-191833	JUNTA	GASKET
10	REC32-860220	32-860220	TUBO SUBIDA AGUA	WATER UP TUBE
11	REC26-88397	26-88397	TUBO GOMA	RUBBER TUBE
12	REC11-859135	859135	TUERCA	NUT
13	REC10-28668	10-28668	TORNILLO	SCREW
14	REC12-45176	12-35935	ARANDELA	WASHER
15	REC10-816601	10-816601	TORNILLO	SCREW
	REC8M2015937	8M2015937	TAPA BABOR	PORT CAP
16	REC8M2015938	8M2015938	TAPA ESTRIBOR	STD CAP
18	REC11-22339	11-22339	TUERCA	NUT
19	REC12-45810	12-45810	ARANDELA TOPE	WASHER
20	REC31-35988A12	31-35988A12	RODAMIENTO (1991-97)	BEARING (1991-97)
21	REC26-823894	26-823894	RETÉN	SEAL
23	REC25-70937	25-70937	ARO TÓRICO	O-RING
	REC3850812	75832T1	CRUCETA (1991-95)	JOINT (1991-95)
26	REC805536A2	805536A2	CRUCETA (1996+)	JOINT (1996+)
	REC75832T	75832T	CRUCETA CARDÁN (4 en línea y V6) (-1995)	U-JOINT (4 inline & V6) (-1995)
29	REC25-25439	25-25439	ARO TORICO	O-RING
	REC25-35027	25-35027	ARO TÓRICO	O-RING
31	REC26-88397A1	26-88397A1	KIT RETENES	GEARCASE SEAL KIT
32	REC27-94996Q2	27-94996Q2	KIT RETENES	GEARCASE SEAL KIT
33	RECKITM2ALPHA2AL	888756Q03	KIT ÁNODOS AL	ANODE KIT AL
34	REC821629Q1AL	821629Q1	ANODO	ANODE

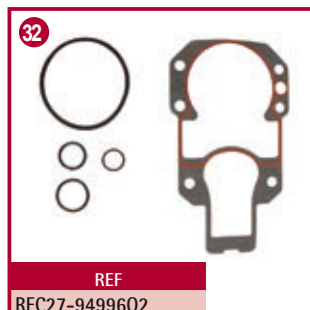

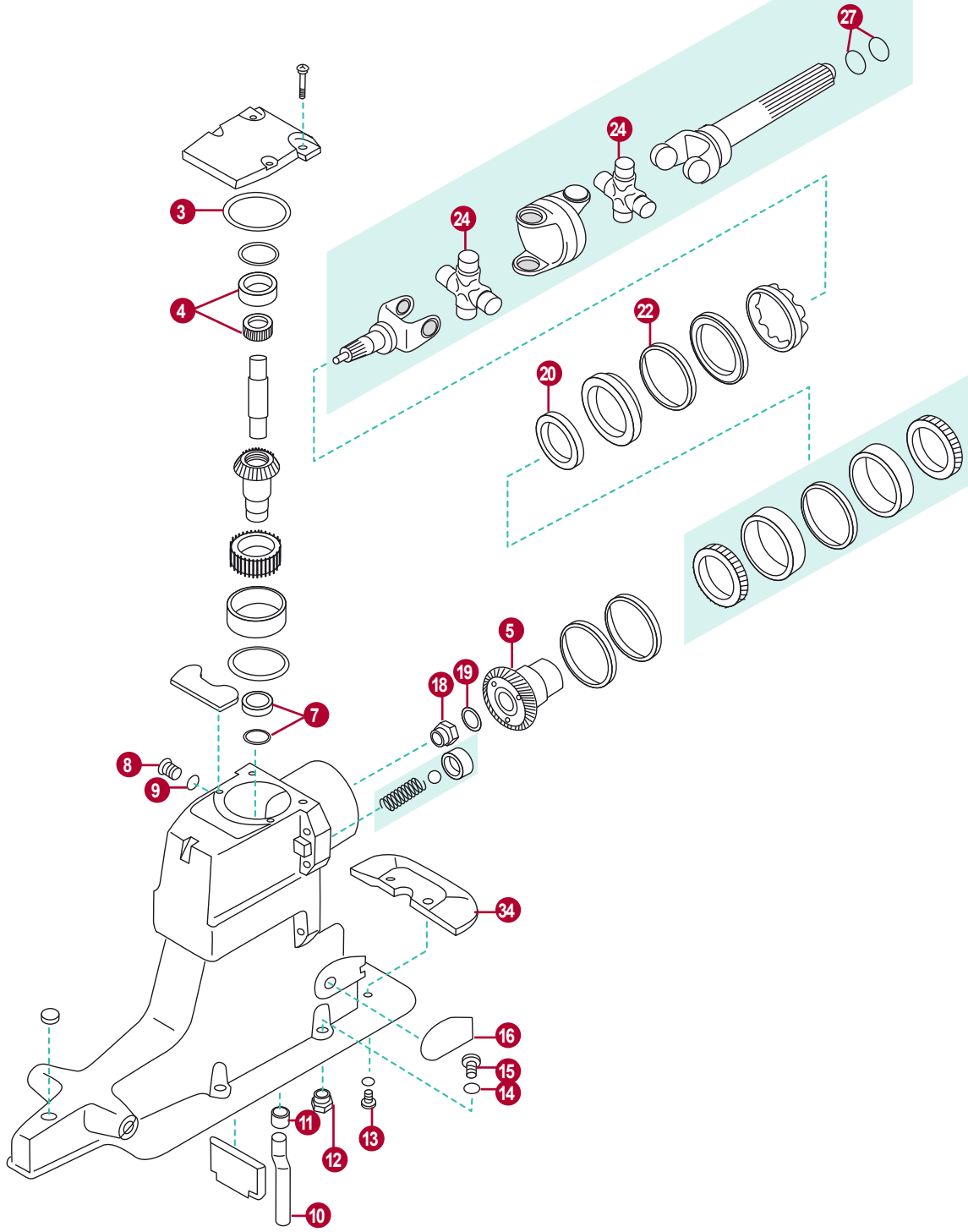

	REF	OEM		
3	REC25-32546	25-32546	ARO	O-RING
4	REC31-32575T1	31-32575T1	COJINETE (O.D. 1-25/32)	BEARING ASSY (O.D. 1-25/32)
7	REC26-66302	26-66302	RETÉN (-OM400411)	OIL SEAL (-OM400411)
	REC26-864319	26-864319	RETÉN (OM400412+)	OIL SEAL (OM400412+)
8	REC10-79953Q04	10-79953Q04	KIT TORNILLOS	SCREW KIT
9	REC12-191833	12-191833	ARANDELA	WASHER
10	REC32-860220	32-860220	TUBO GUÍA	GUIDE TUBE
11	REC26-88397	26-88397	GRUESO	GROMMET
12	REC11-859135	11-859135	TUERCA	LOCKNUT
13	REC10-28668	10-28668	TORNILLO	SCREW
14	REC12-45176	12-35935	ARANDELA	WASHER
15	REC10-816601	10-816601	TORNILLO	BOLT
16	REC8M2015937	8M2015937	GRUESO BABOR	WEAR PAD - PORT
	REC8M2015938	8M2015938	GRUESO ESTRIBOR	WEAR PAD - STARBOARD
18	REC11-22339	11-22339	TUERCA	NUT
19	REC12-45810	12-45810	ARANDELA TOPE	WASHER
20	REC26-823894	26-823894	RETÉN ACEITE	OIL SEAL
22	REC25-70937	25-70937	ARO TÓRICO	O-RING
24	REC805536A2	805536A2	CRUCETA CARDAN (-OM400411)	U-JOINT (-OM400411)
	REC865496A02	865496A02	CRUCETA CARDAN (OM400412+)	U-JOINT (OM400412+)
27	REC25-25439	25-25439	ARO	O-RING
	REC25-35027	25-35027	ARO	O-RING
29	REC26-88397A1	26-88397A1	KIT RETENES	GEARCASE SEAL KIT
30	REC27-94996Q2	27-94996Q2	KIT RETENES	GEARCASE SEAL KIT
33	RECKITMALPHA2AL	888756Q03	KIT ÁNODOS AL	ANODE KIT AL
34	REC821629Q1AL	821629Q1	ANODO	ANODE

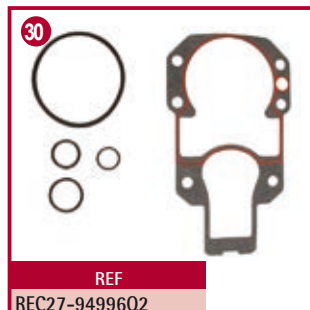

ALPHA ONE GEN II STD & COUNTER ROTATION

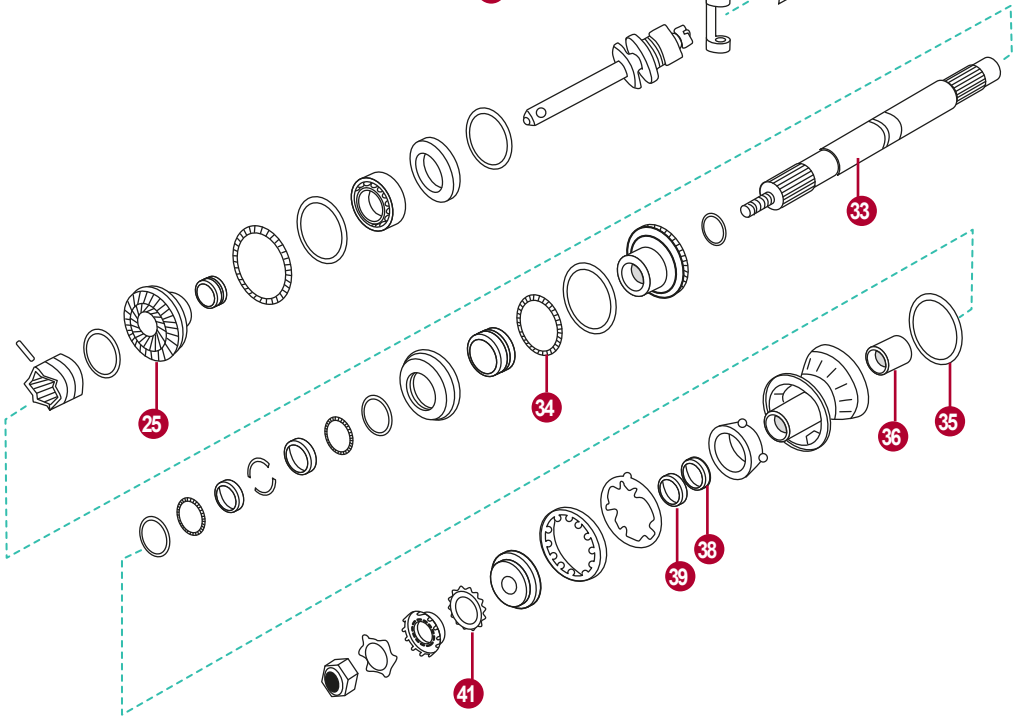
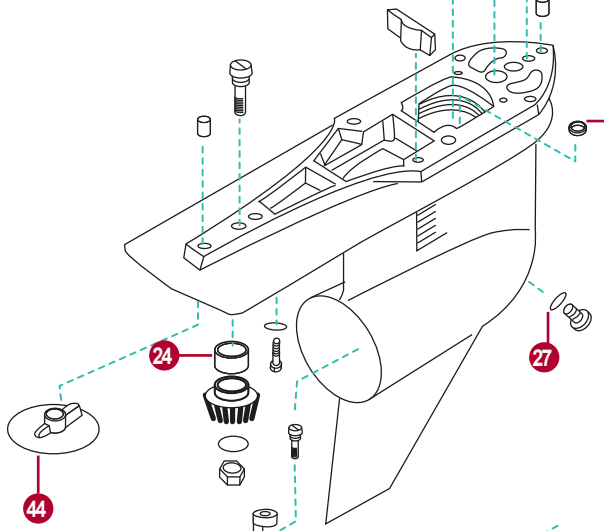
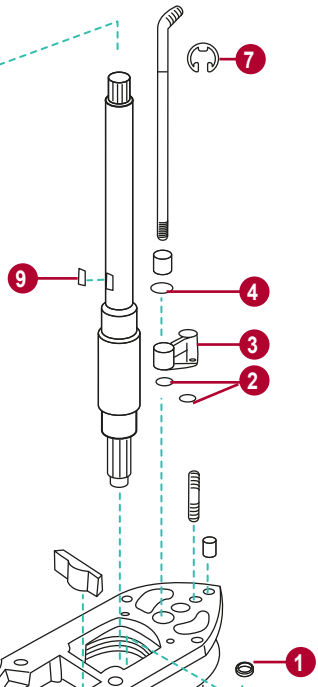
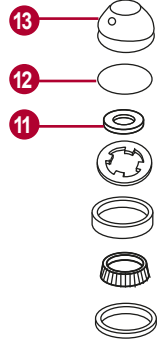
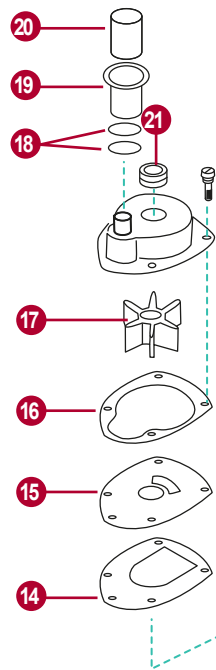

	REF	OEM		
1	REC26-455771	26-45577-1	RETÉN	SEAL
2	REC25-36318	25-36318	ARO TÓRICO	O-RING
3	REC23-815921A21	23-815921A21	CASQUILLO	SHIFT BUSHING
4	REC26-8164641	26-816464-1	RETÉN ACEITE	OIL SEAL
7	REC53-29641	53-29641	CIERRE	CIRCLIP
9	REC28-8M0032833	28-8M0032833	CHAVETA	CLIP
11	REC26-66302	26-66302	RETÉN ACEITE (-0M400411)	OIL SEAL (-0M400411)
	REC26-864319	26-864319	RETÉN ACEITE (0M400411+)	OIL SEAL (0M400411+)
12	REC25-90011	25-90011	ARO TÓRICO	O-RING
13	REC807929A1	807929A1	PORTA RETÉN (1991+)	SEAL BASE (1991+)
14	REC27-430331	27-430331	JUNTA	GASKEET
15	REC8172761	8172761	TAPA BOMBA AGUA	PUMP CAP
16	REC27-8172771	27-8172771	JUNTA	GASKET
17	REC47-43026Q02	47-43026Q02	IMPULSOR	IMPELLER
18	REC25-21836	25-21836	ARO TÓRICO	O-RING
19	REC816597A1	816597A1	TUBO AGUA	TUBE
20	REC23-816583	23-816583	TUBO	TUBE
21	REC26-816575A2	26-816575A2	RETÉN GOMA	SEAL
23	REC26-816575A3	26-816575A3	KIT REPARACIÓN	REPAIR KIT
24	REC387817	31-42647A1	RODAMIENTO	BEARING
27	REC12-191833	12-191833	JUNTA TAPÓN	CAP GASKET
33	REC44-850308	44-850308	EJE HÉLICE (1998+) (0L100040+)	SHAFT PROPELLER (1998+) (0L100040+)
34	REC30-88957T	30-88957T1	RODAMIENTO	BEARING
35	REC25-31534	25-31534	ARO TÓRICO	O-RING
36	REC387247	31-30956T	RODAMIENTO	BEARING
38	REC26-76868	26-14077	RETÉN ACEITE Interior	OIL SEAL Inside
39	REC26-12224	26-12224	RETÉN ACEITE Exterior	OIL SEAL Outside
41	REC13-423511	13-423511	CIERRE	CLIP
42	REC11-52707Q1	11-52707Q1	KIT CIERRE HÉLICE	PROPELLER NUT KIT
43	RECKITMALPHA2AL	888756Q03	KIT ÁNODOS AL	ANODE KIT AL
44	REC76214Q5AL	76214Q5	ÁNODO	ANODE

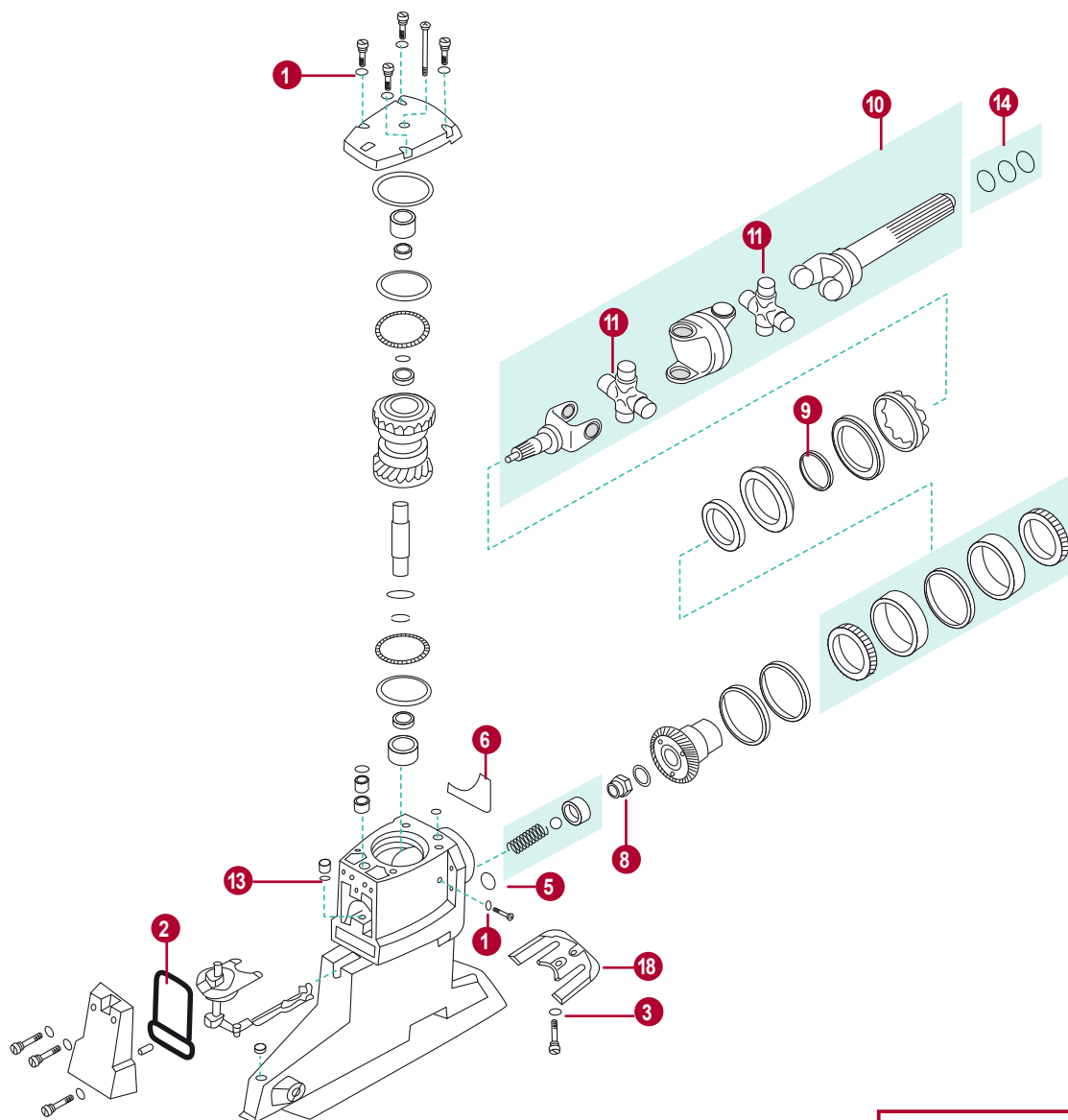

	REF	OEM		
1	REC12-191833	12-191833	JUNTA	GASKET
2	REC12708	12708	RETÉN	RETAINER
3	REC13-35048	13-35048	ARANDELA	WASHER
5	REC25-457101	25-457101	ARO TÓRICO (1.424 x 103)	O-RING (1.424 x 103)
6	REC86310	16755Q1	RETÉN	RETAINER
8	REC11-22339	11-22339	TUERCA	NUT
9	REC26-807006	26-807006	RETÉN ACEITE Ø 2.254"	OIL SEAL Ø 2.254"
	REC26-43993	26-43993	RETÉN ACEITE Ø 2.132"	OIL SEAL Ø 2.132"
10	REC864244A2	864244A2	KIT TRANSMISIÓN	KIT TRANSMISION
11	REC3850812	75832	CRUCETA	U-JOINT
	REC865496A02	865496A01	CRUCETA BRAVO (0M111208+)	U-JOINT BRAVO (0M111208+)
14	REC25-35027	25-35027	ARO TÓRICO (1.046)	O-RING (1.046)
15	REC26-16709A2	26-16709A2	KIT REPARACIÓN BRAVO I, II, III	GEARCASE SEAL KIT BRAVO I, II, III
16	RECKITMBRAVO1AL	888758Q02	KIT ÁNODOS AL	ANODE KIT AL
17	REC26-12709	26-12709	RETÉN EJE DE CAMBIO	OIL SEAL
18	REC821630Q1AL	821630A1	ÁNODO	ANODE

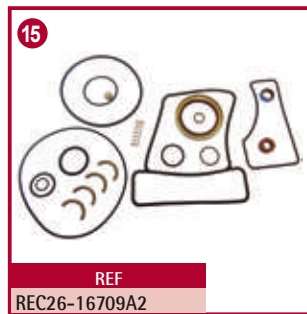

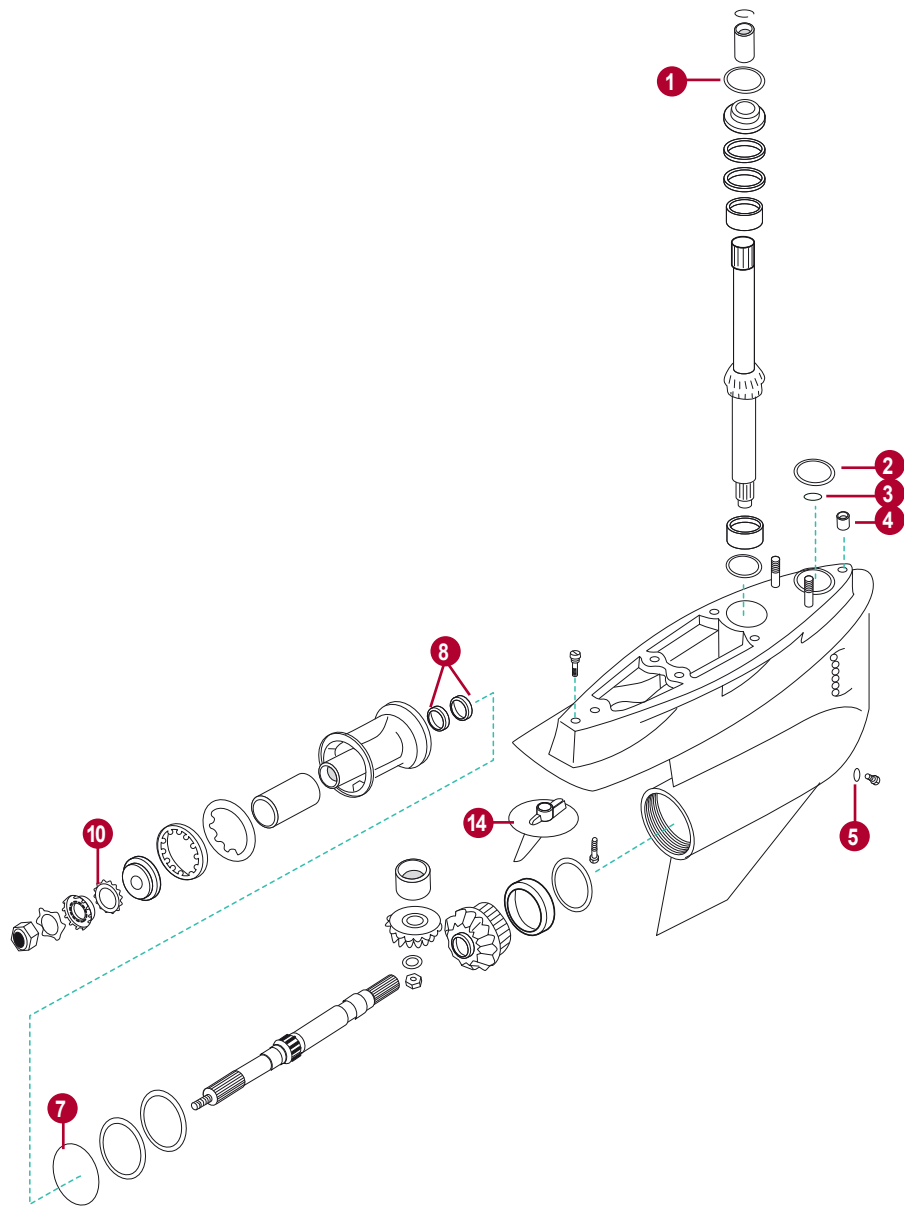

	REF	OEM		
1	REC308627	25-20826	ARO TÓRICO	O-RING
2	REC26-455771	26-455771	RETÉN	SEAL
3	REC25-33465	25-33465 25-822370	ARO TÓRICO (2.362 x .103)	O-RING (2.362 x .103)
4	REC26-36556	26-36556	TUBO AGUA Ø EXT. 12.7 mm	WATER TUBE Ø EXT. 12.7mm
	REC26-805344	26-805344	TUBO AGUA Ø EXT. 15.88 mm	WATER TUBE Ø EXT. 15.88 mm
5	REC12-191833	12-191833	JUNTA	GASKET
7	REC25-31534	25-31534	ARO TÓRICO	O-RING
8	REC26-76868	26-76868	RETÉN ACEITE	OIL SEAL
10	REC13-423511	13-42351-1	CIERRE	LOCK
11	REC11-52707Q1	11-52707Q1	KIT CIERRE HÉLICE	PROPELLER NUT KIT
12	REC26-76868A04	26-76868A04	KIT REPARACIÓN BRAVO I, II, III	GEARCASE SEAL KIT BRAVO I, II, III
13	RECKITMBRAVO1AL	888758Q02	KIT ÁNODOS AL	ANODE KIT AL
14	REC76214Q5AL	76214Q5	ÁNODO	ANODE



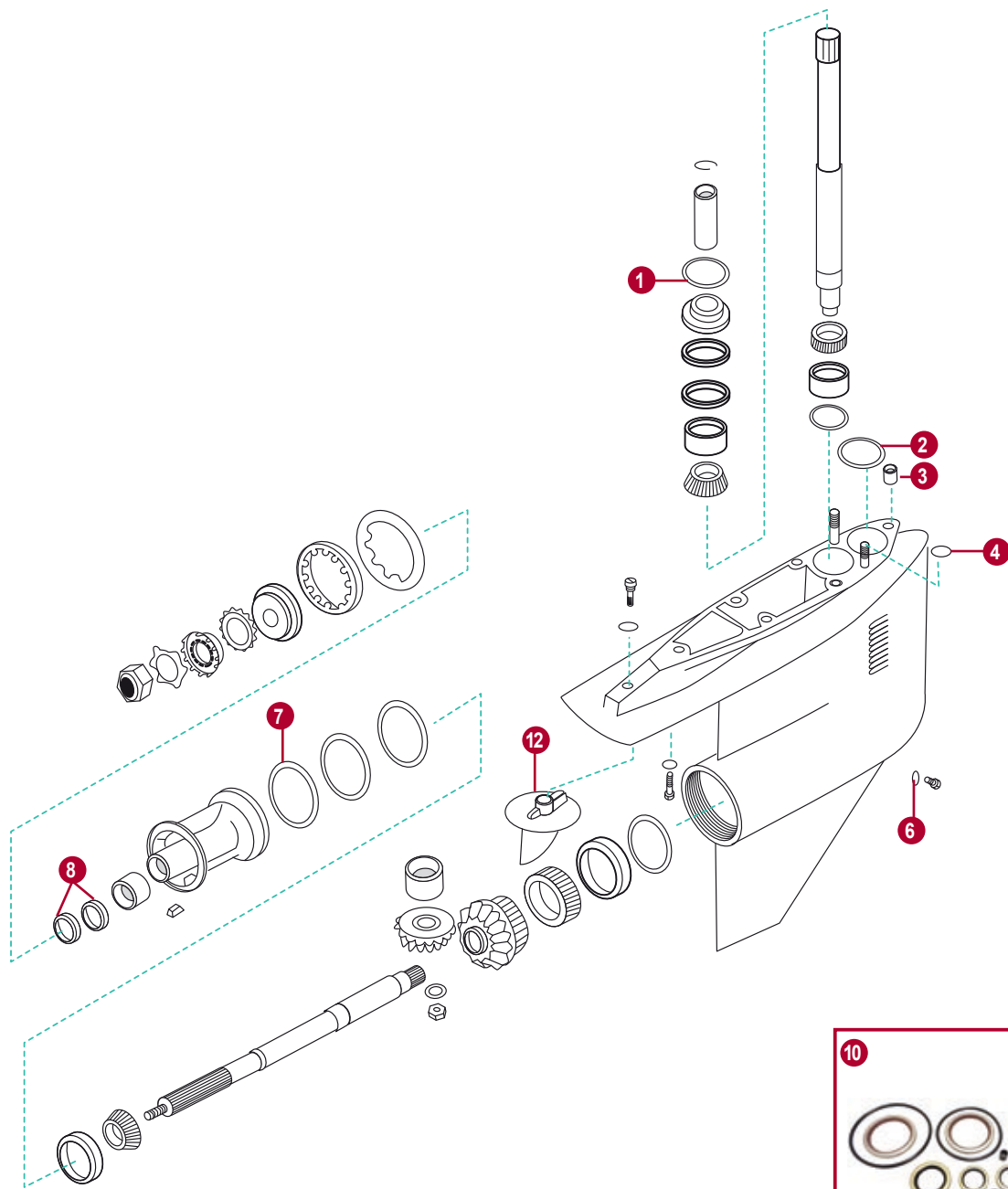

	REF	OEM		
1	REC308627	25-20826	ARO TÓRICO	O-RING
2	REC25-33465	25-822370	ARO	O-RING
3	REC26-805344	26-805344	RETÉN AGUA Ø15.88 mm	SPEEDOMETER SEA Ø15.88 mm
	REC26-36556	26-36556	RETÉN AGUA Ø 12.7 mm	SPEEDO GROMMET Ø 12.7 mm
4	REC26-455771	26-455771	RETÉN	SEAL
6	REC12-191833	12-191833	JUNTA	GASKET
7	REC25-34821	25-34821	TÓRICA	O-RING
8	REC26-76868	26-76868	RETÉN	SEAL
10	REC26-76868A04	26-76868A04	KIT REPARACIÓN BRAVO I, II, III	GEARCASE SEAL KIT BRAVO I, II, III
11	RECKITMBRAVO23AL	888761Q03	KIT ÁNODOS AL	ANODE KIT AL
12	REC762144AL	762144	ÁNODO	ANODE



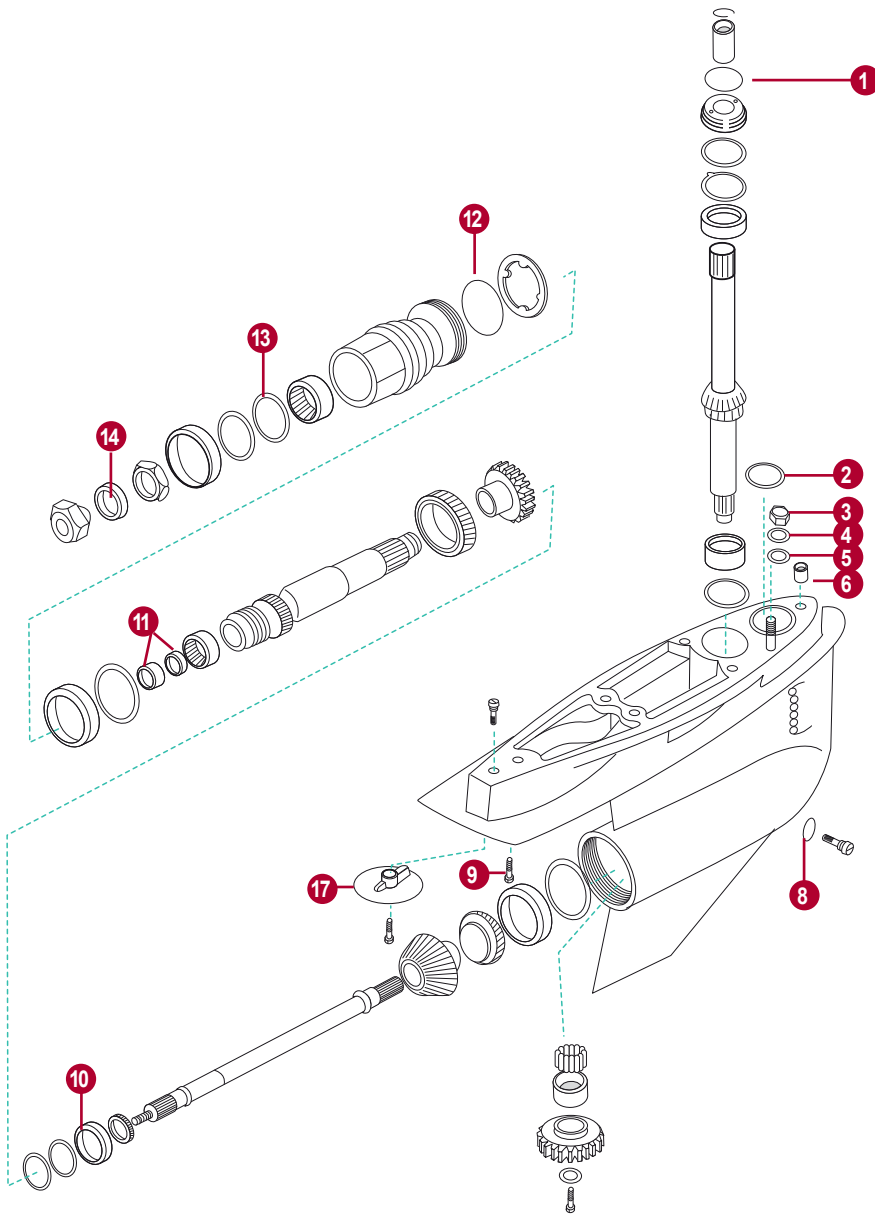



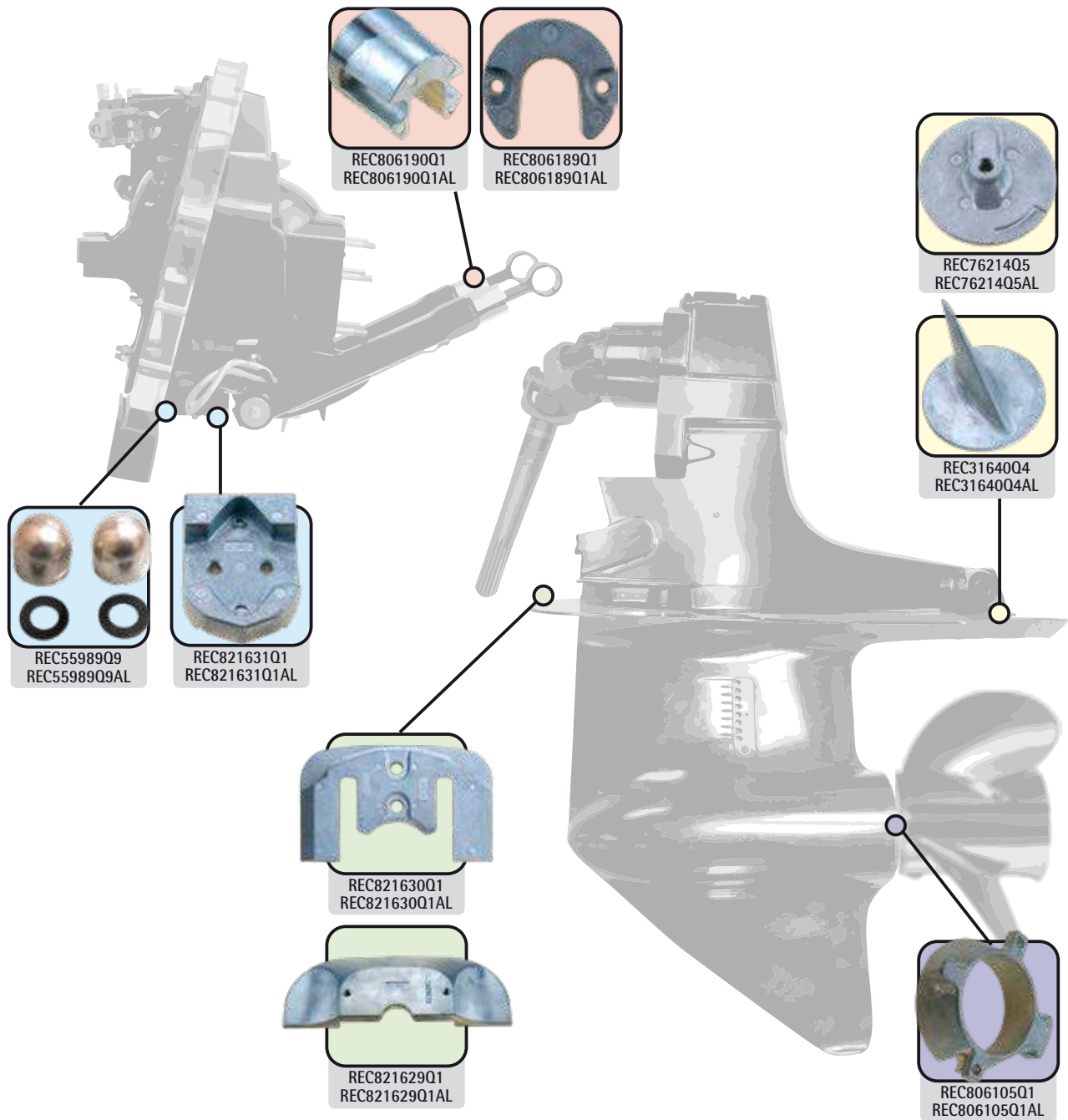

	REF	OEM		
1	REC308627	25-20826	ARO TÓRICO	O-RING
2	REC25-33465	25-33465	ARO TÓRICO	O-RING
3	REC11-34933	11-859116	TUERCA	NUT
4	REC12-45176	12-45176	ARANDELA	WASHER
5	REC26-455771	26-45577-1	RETÉN	SEAL
6	REC26-805344	26-805344	RETÉN	SEAL
8	REC12-191833	12-19183-3	JUNTA	GASKET
9	REC10-816601	10-816601	TORNILLO	SCREW
10	REC805100	805100	SEPARADOR	THRUST WASHER
11	REC26-8M0033407	26-8M0033407	RETÉN ACEITE	OIL SEAL
12	REC3852865	25-805331	ARO TÓRICO	O-RING
13	REC26-861694	26-861694	RETÉN ACEITE	OIL SEAL
14	REC805101T	805101T	SEPARADOR	THRUST WASHER
15	REC26-76868A04	26-76868A04	KIT REPARACIÓN BRAVO I, II, III	GEARCASE SEAL KIT BRAVO I, II, III
16	RECKITMBRAVO3AL	888761Q04	KIT ÁNODOS AL	ANODE KIT AL
17	REC76214Q5AL	76214Q5	ANODO	ANODE
	REC762144AL	762144	ANODO	ANODE









	PLACA PLATE	TRANSOM	PISTÓN PISTON	HÉLICE PROPELLER	TRIM TAB	KITS
BRAVO I	REC821630Q1 REC821630Q1AL		REC806190Q1 REC806190Q1AL		REC76214Q5 REC76214Q5AL	RECKITMBRAVO1ZN RECKITMBRAVO1M RECKITMBRAVO1AL
BRAVO II	REC821630Q1 REC821630Q1AL		REC806190Q1 REC806190Q1AL		REC76214Q5 REC76214Q5AL	RECKITMBRAVO23ZN RECKITMBRAVO23M RECKITMBRAVO23AL
BRAVO III	REC821630Q1 REC821630Q1AL		REC806190Q1 REC806190Q1AL		REC76214Q5 REC76214Q5AL	RECKITMBRAVO3ZN RECKITMBRAVO3M RECKITMBRAVO3AL
ALPHA ONE		REC821631Q1 REC821631Q1AL	REC806189Q1 REC806189Q1AL		REC31640Q4 REC31640Q4AL	RECKITMALPHA1ZN RECKITMALPHA1M RECKITMALPHA1AL
ALPHA ONE II GEN	REC821629Q1 REC821629Q1AL	REC821631Q1 REC821631Q1AL	REC806189Q1 REC806189Q1AL	REC806105Q1 REC806105Q1AL	REC76214Q5 REC76214Q5AL	RECKITMALPHA2ZN RECKITMALPHA2M RECKITMALPHA2AL



		OEM	
	(kg)		
ZN REC821630Q1	1,00	821630Q1	
AL REC821630Q1AL	0,39		

		OEM	
	(kg)		
ZN REC821631Q1	0,89	821631Q1	
AL REC821631Q1AL	0,35		

		OEM	
	(kg)		
ZN REC821629Q1	0,78	821629Q1	
AL REC821629Q1AL	0,30		



		OEM	
	(kg)		
ZN REC806190Q1	0,36	806190Q1	
AL REC806190Q1AL	0,14		



		OEM	
	(kg)		
ZN REC806189Q1	0,10	806189Q1	
AL REC806189Q1AL	0,04		



		OEM	
	(kg)		
ZN REC76214Q5	0,33	76214Q5	
AL REC76214Q5AL	0,13		



		OEM	
	(kg)		
ZN REC31640Q4	0,55	31640Q4	
AL REC31640Q4AL	0,21		



		OEM	
	(kg)		
ZN REC806105Q1	0,23	806105Q1	
AL REC806105Q1AL	0,09		



		OEM	
	(kg)		
ZN REC42121Q02	0,03	42121Q02	
AL REC42121Q02AL	0,01		



REF	OEM			
		(kg)		
ZN REC34127T2	34127	0,59	80 - 140 HP	
AL REC34127T2AL		0,22		

REF	OEM			
		(kg)		
ZN REC94286T1	94286	0,27	25 HP	
AL REC94286T1AL		0,10		



REF	OEM			
		(kg)		
ZN REC47820A1	47820	0,33	20 HP	
AL REC47820A1AL		0,13		

REF	OEM			
		(kg)		
ZN REC46399	46399	0,36	50 - 140 HP	
AL REC46399AL		0,14		

REF	OEM			
		(kg)		
ZN REC806188Q01	806188	0,15	BRAVO I, III	
AL REC806188Q01AL		0,06		

REF	OEM			
		(kg)		
ZN REC762144	76214-4	0,31		
AL REC762144AL		0,13		

REF	OEM			
		(kg)		
ZN REC76214T1	76214	0,28	VERADO - BRAVO	
AL REC-76214T1AL		0,11		

REF	OEM			
		(kg)		
ZN REC865182Q01	865182	0,51	BRAVO III	
AL REC865182Q02AL		0,42		

REF	OEM	(kg)	
ZN REC34762A1	34762A1	0,24	
AL REC34762A1AL		0,09	

REF	OEM	(kg)	
ZN REC879150A65	879150A65	2,48	
AL REC879150A65AL	8M0039340	0,89	

REF	OEM	(kg)	
ZN REC822777Q1	822777Q1	0,67	
AL REC822777Q1AL		0,24	

REF	OEM	(kg)	
AL REC865182Q02AL	865182Q01	0,19	

REF	OEM	(kg)	
ZN REC55989Q9		0,11	
AL REC55989Q9AL	55989Q9	0,04	
MG REC55989Q9M		0,03	

REF	OEM	(kg)		
ZN REC821631Q1	43994	0,95		ALPHA
AL REC821631Q1AL		0,34		GEN II
				BRAVO

KITS ANODOS ANODES KIT

REF	OEM	
ZN RECKITMALPHA1ZN	888756Q04	ALPHA 1
AL RECKITMALPHA1AL		
MG RECKITMALPHA1M RECKITMMPHA1M		
ZN RECKITMALPHA2ZN	888756Q03	ALPHA 2
AL RECKITMALPHA2AL		
MG RECKITMALPHA2M RECKITMMPHA2M		



REF	OEM	
ZN RECKITMBRAVO1ZN	888758Q02	BRAVO 1
AL RECKITMBRAVO1AL		
MG RECKITMBRAVO1M		
ZN RECKITMBRAVO23ZN	888761Q03	BRAVO 2
AL RECKITMBRAVO23AL		
MG RECKITMBRAVO23M		
ZN RECKITMBRAVO3ZN	888761Q04	BRAVO 3
AL RECKITMBRAVO3AL		
MG RECKITMBRAVO3M		

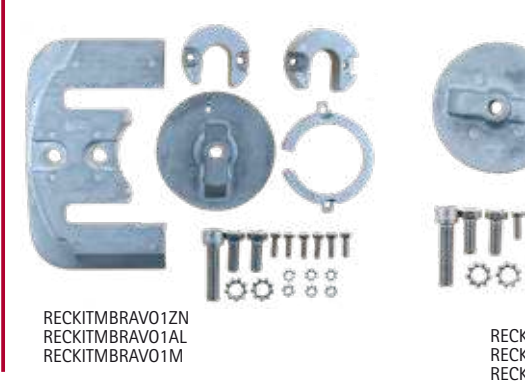

# TRANSOM

KITS DE TRANSOM Y PISTÓN DIRECCIÓN  
ALPHA ONE GEN I & II

GIMBAL HOUSING & POWER STEERING CYLINDER KIT  
ALPHA ONE GEN I & II

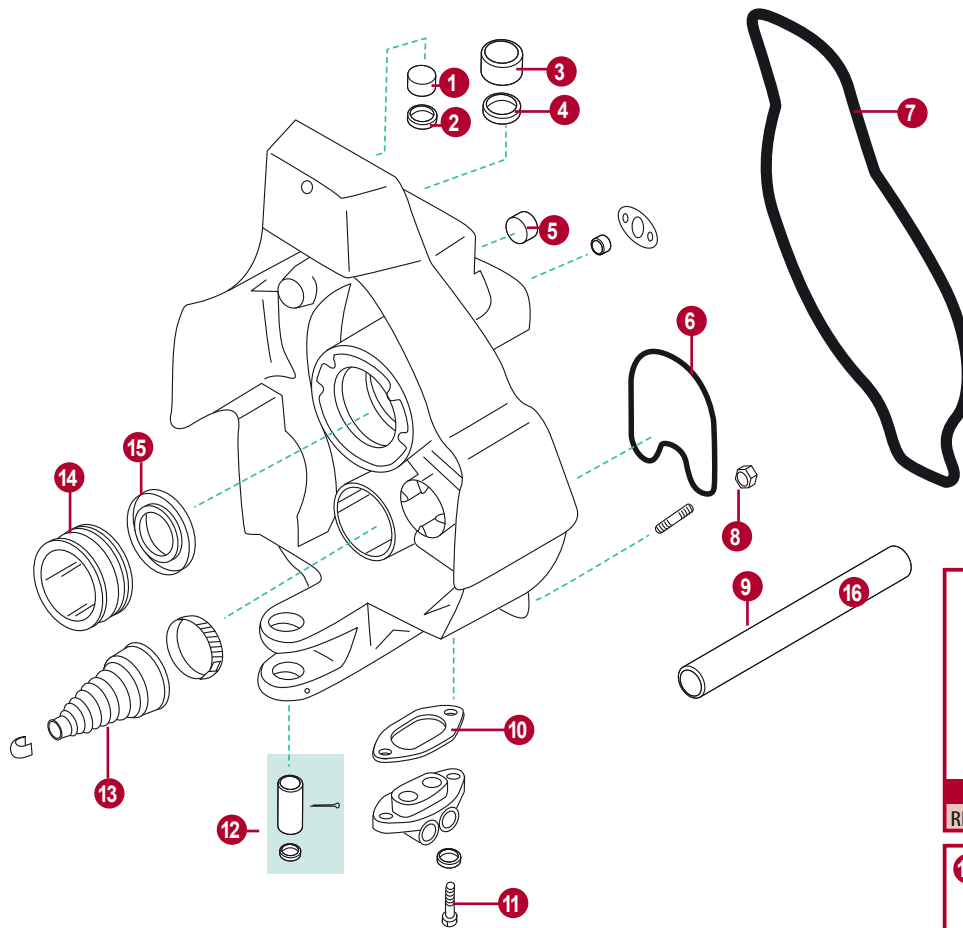

REF	OEM		
1	RM23-98356	23-98356	CASQUILLO SUPERIOR UPPER BUSHING
2	REC26-54925	26-54925	RETÉN (Alpha one) SEAL (Alpha one)
3	RM23-983571	23-983571	CASQUILLO INFERIOR LOWER BUSHING
4	REC26-55682	26-55682	RETÉN (Alpha one) SEAL (Alpha one)
	REC26-8M2005029	26-416071	RETÉN (Alpha one Gen II) SEAL (Alpha one Gen II)
5	REC22-73379	22-73379	TAPÓN (.250-18) CAP (.250-18)
6	REC41802	41802	RETÉN SEAL
	REC43713	43713	JUNTA TRANSOM (Gen II, Bravo) BLACKHAWK TRANSOM SEAL (Gen II, Bravo)
7	REC65533A1	65533A1	JUNTA TRANSOM (MC1/R/Alpha one) TRANSOM SEAL (MC1/R/Alpha one)
8	REC11-34933	11-34933	TUERCA NUT
	REC32-4172533	32-4172533	TUBO AGUA Ø 3/4" Ø 3/4" WATER HOSE
	REC32-32461	32-32461	TUBO AGUA Ø 5/8" Ø 5/8" WATER HOSE
10	REC27-988231	27-988231	JUNTA GASKET
11	REC10-28668	10-28636	TORNILLO SCREW
12	REC17-8M0073409	8M0073409	KIT PIN KIT PIN
13	REC74639Q02	74639Q02	FUELLE CABLE CAMBIO SHIFT BELLOW
14	REC30-879194A01	30-879194A01	COJINETE TRANSOM (Alpha one Gen I, II) GIMBAL BEARING FOR TRANSOM (Alpha one Gen I, II)
15	REC26-88416	26-88416	RETÉN SEAL
16	REC30-879194A01	30-879194A01	COJINETE TRANSOM (Alpha one Gen I, II) GIMBAL BEARING FOR TRANSOM (Alpha one Gen I, II)
17	REC55989Q9	55989Q9	KIT ÁNODO AL ANODE AL KIT
18	REC27-995061	27-995061	JUNTA GASKET
19	REC8M0080805	8M0080805	KIT CONECTOR TRIM TRIM CONNECTOR KIT

CAMPAÑA TRANSOM, CABLE CAMBIO Y BOMBA DIRECCION

TRANSOM PLATE, SHIFT CABLE & PUMP ASSY. POWER STEERING

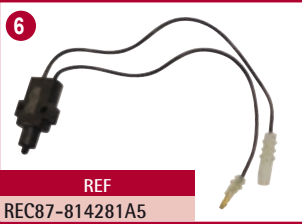

REF  
REC87-814281A5



REF  
REC87-808009A2



REF  
REC8M0052939



REF  
REC73873A1



REF  
REC861578

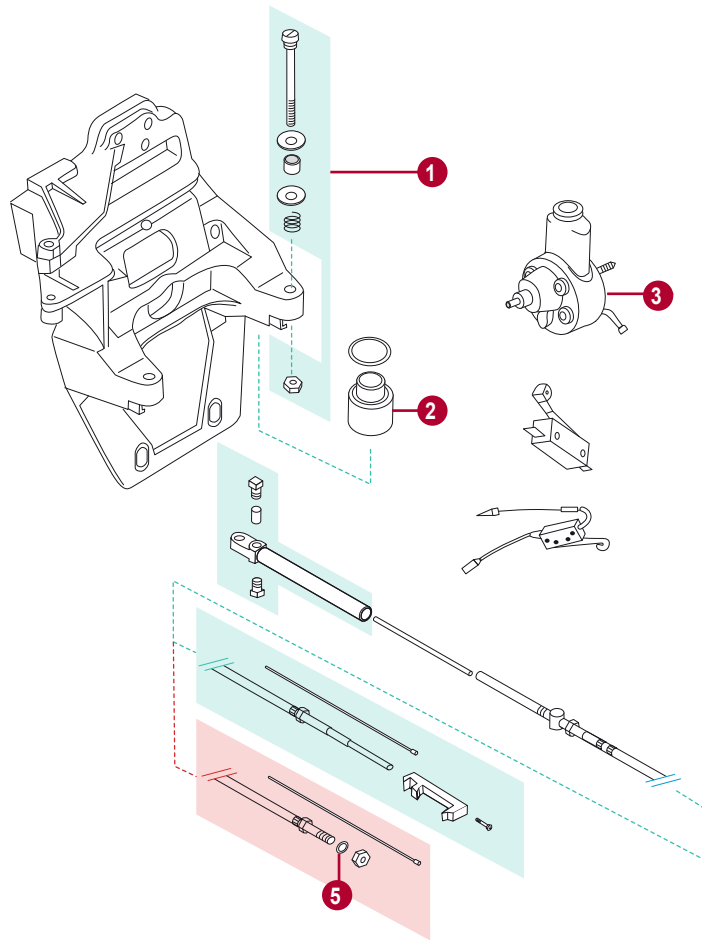

	REF	OEM		
1	REC10-97934A1	10-97934A1	KIT MONTAJE SILENTBLOCK CAMPAÑA	MOTOR MOUNT BOLT KIT
2	REC865329A02	865329A02	SILENTBLOCK MOTOR	MOTOR MOUNT SILENTBLOCK
3	REC16792A39	16792A39	BOMBA DIRECCIÓN	PUMP ASS. POWER STEERING
5	REC12-815472	12-815472	ARANDELA (Bravo)	WASHER (Bravo)
6	REC87-814281A5	87-814281A5	MICRORRUPTOR 3.0L, LX, 4.3L, LXL, 5.0L & 5.7, LX (1996+)	SHIFT PLATE KIT 3.0L, LX, 4.3L, LXL, 5.0L & 5.7, LX (1996+)
7	REC87-808009A2	87-808009A2 87-8M0052935 8M0052939	MICRORRUPTOR 4.3MPI, 5.0LMPI, 350MAG MPI, MX, 6.2L MPI	SHIFT PLATE KIT 4.3MPI, 5.0LMPI, 350MAG MPI, MX, 6.2L MPI
8	REC8M0052939	889514A01 814281A7	INTERRUPTOR DIGITAL CAMBIO GASOLINA Y GASOIL	SWITCH DIGITAL THROTTLE FUEL & DIESEL
9	REC73873A1	73873A1	POLEA "V" BOMBA SERVO	P/S PUMP PULLEY
10	REC861578	861578	POLEA SERPENTÍN	P/S PUMP PULLEY

**SOPORTE TRANSOM  
ALPHA ONE GEN II**

**GIMBAL HOUSING RING ASSEMBLY  
ALPHA ONE GEN II**

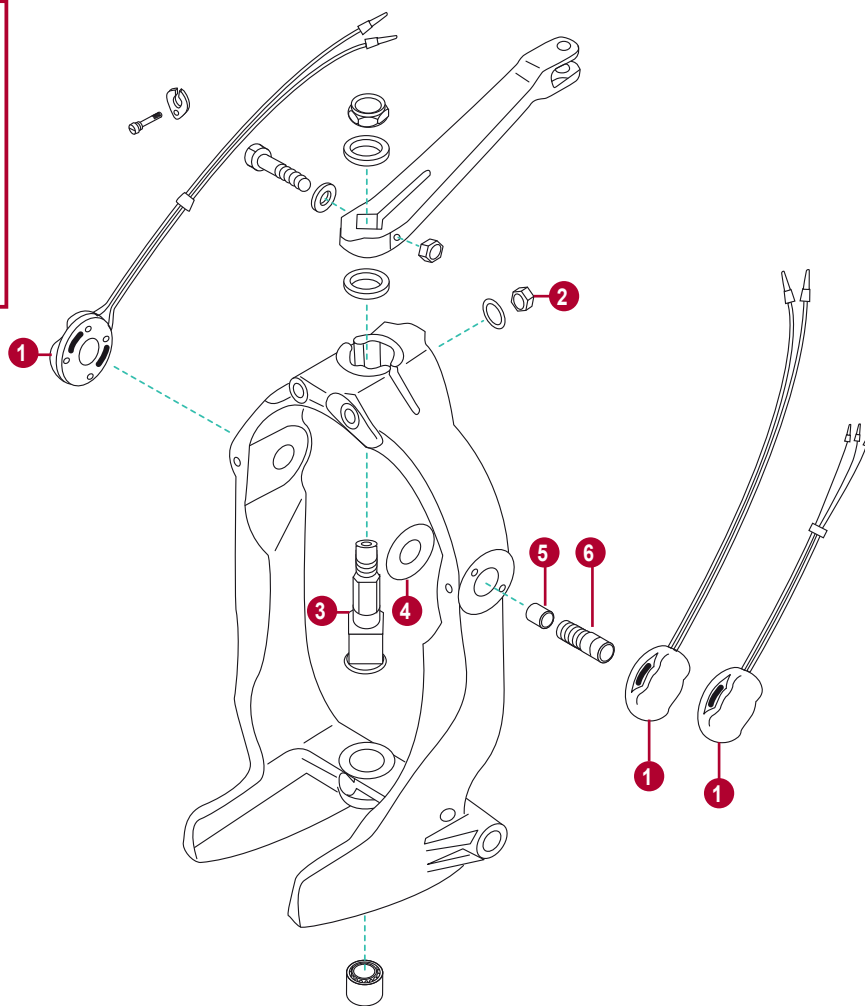

	REF	OEM		
<b>1</b>	REC805320A03	805320A03	KIT SENSORES TRIM ANALÓGICO	TRIM SENSOR KIT. ANALOGICAL
	REC8M0095310	8M0095310	KIT SENSOR TRIM DIGITAL	TRIM SENSOR KIT. DIGITAL
<b>2</b>	REC11-862903	11-134371	TUERCA	NUT
<b>3</b>	REC98230A1	98230A1	EJE	SHAFT
<b>4</b>	RM12-41721	12-41721	ARANDELA	WASHER
<b>5</b>	REC23-847637	23-847637	CASQUILLO	BUSING
<b>6</b>	REC77123	77123	TORNILLO ALPHA (-1998) (-0M815638)	ALPHA SCREW (-1998) (-0M815638)
	REC10-86801	10-86801	TORNILLO ALPHA (1998+) (0M85639+)	ALPHA SCREW (1998+) (0M85639+)

**CAMPANA TRANSOM**  
MC, MR1, ALPHA ONE, ALPHA ONE GEN II

**BELL HOUSING**  
MC, MR1, ALPHA ONE, ALPHA ONE GEN II



REF  
REC23-806036A1

REF  
REC8M0052939

REF  
REC22-861150T02

REF  
RM22-861163

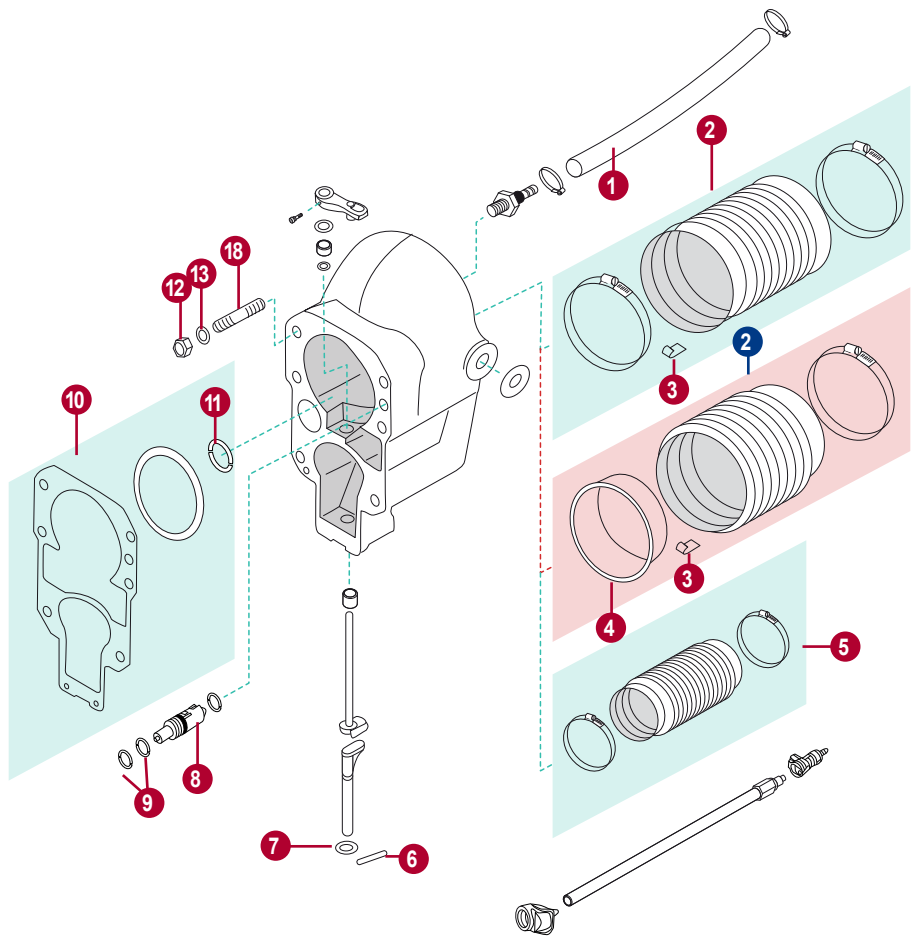

	REF	OEM		
1	REC32-4172533	32-4172533	TUBO AGUA Ø 3/4 137/8"L	WATER HOSE Ø 3/4 137/8"L
	REC32-32461	32-32461	TUBO AGUA Ø 5/8 137/8"L	WATER HOSE Ø 5/8 137/8"L
2	REC60932A4	60932A4	KIT FUELLE (3469428+) R/MR/ALPHA ONE	U-JOINT BELLOW (3469428+) KIT R/MR/ALPHA ONE
2	REC816431A1	816431A1	KIT FUELLE (Alpha one Gen II)	U-JOINT BELLOW KIT (Alpha one Gen II)
3	REC54-86049	54-86049	CLIP FUELLE	GROUNDING CLIP
4	REC816607	816607	CASQUILLO FUELLE	BELLOW FLANGE RING
5	REC18654A1	18654A1	KIT FUELLE ESCAPE	U-JOINT BELLOW KIT
6	REC18-32665	18-32665	PASADOR	COTTER PIN
7	REC12-32666	12-32666	ARANDELA	WASHER
8	REC18920A1	18920A1	VÁLVULA COMPLETA	VALVE ASSY
9	REC25-48171	25-48171	ANILLO	O-RING
10	REC27-94996Q2	27-94996Q2	KIT JUNTAS TRANSOM (Alpha one Et Gen II)	GASKET KIT (Alpha one Et Gen II)
	REC27-64818Q4	27-64818Q4	KIT JUNTAS TRANSOM (MC1)	GASKET KIT (MC1)
11	REC0307239	25-33504	ARO TÓRICO	O-RING
12	REC11-34933	11-134391	TUERCA (.4375-20)	NUT (.4375-20)
13	REC12-45176	12-35935	ARANDELA (.435 x .875 x .105)	WASHER (.435 x .875 x .105)
14	REC23-806036A1	23-806036A1	KIT RETENES Alpha Gen II, (F094775+)	SHIFT SHAFT BUSING Alpha Gen II, (F094775+)
15	REC45518T1	45518T1	KIT CAMBIO	SHIFT LEVER KIT
16	REC22-861150T02	22-861150A1	RACOR ACEITE	OIL RACORD
17	RM22-861163	22-861163	RACOR ACEITE	OIL RACORD
18	REC16-59579	16-59579	PASADOR	SETTING PIN

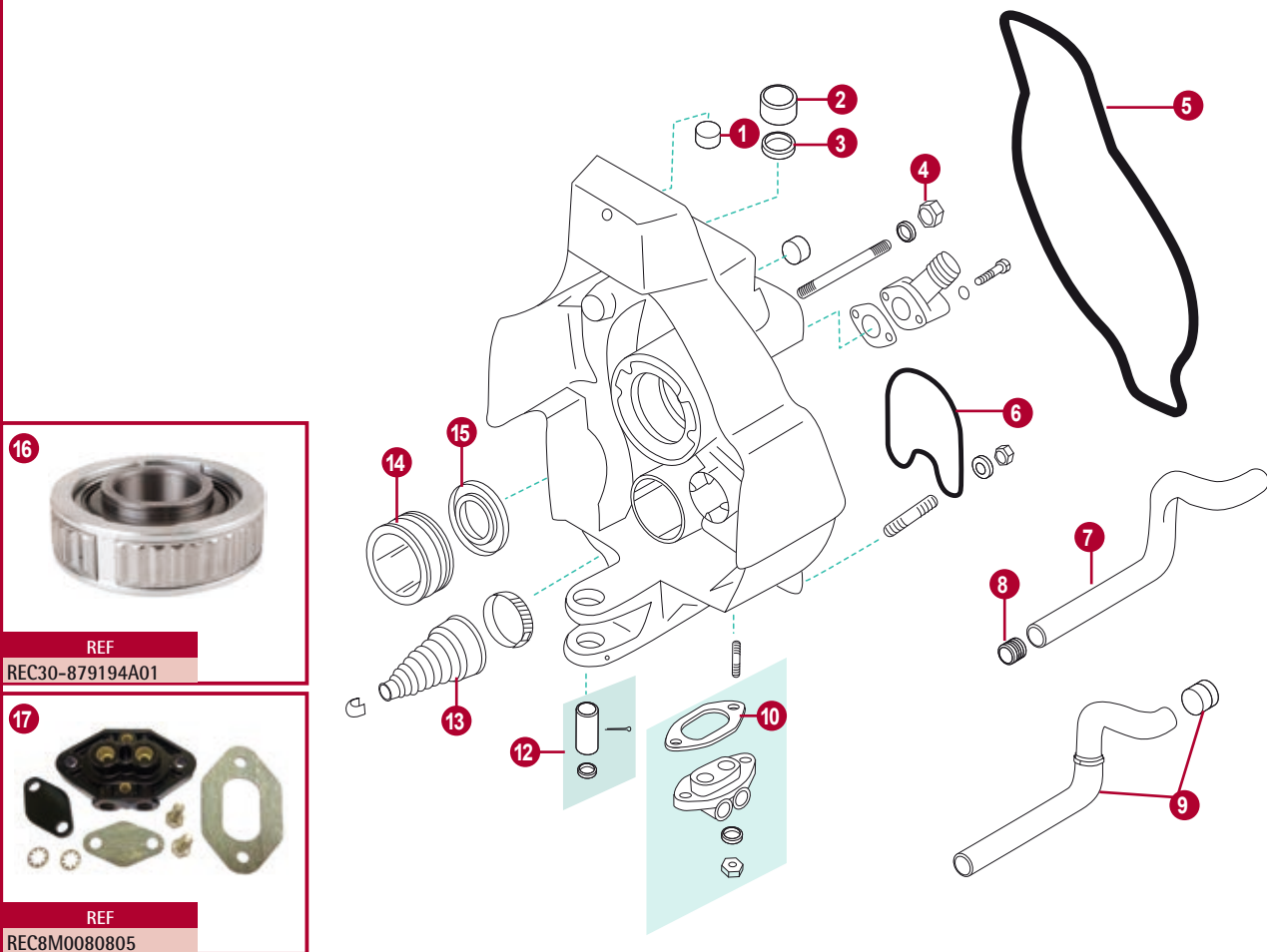

	REF	OEM		
1	RM23-98356	23-98356	CASQUILLO SUPERIOR	UPPER BUSHING
2	RM23-983571	23-983571	CASQUILLO INFERIOR	BUSHING - LOWER
3	REC26-8M2005029	26-416071	RETÉN	OIL SEAL
4	REC11-34933	11-34933	TUERCA	NUT
5	REC43713	43713	JUNTA TRANSOM	TRANSOM SEAL
6	REC41802	41802	RETÉN	SEAL
7	REC32-43437	32-43437	TUBO AGUA DESIGN I	WATER HOSE DESIGN I
8	REC41674T	41674T	CASQUILLO	INSERT
9	REC8M0062102	32-8M0062102	TUBO DE AGUA DESIGN II	WATER HOSE DESIGN II
10	REC27-988231	27-988231	JUNTA	GASKET
12	REC17-8M0073409	17-8M0073409	KIT PIN	PIN SET
13	REC74639Q02	74639Q02	FUELLE CABLE CAMBIO	SHIFT CABLE BELLOW
14	REC30-879194A01	879194A01 Et A02	COJINETE	GIMBAL BEARING
15	REC26-88416	26-88416	RETÉN ACEITE	OIL SEAL
16	REC30-879194A01	30-879194A01	COJINETE	BEARING
17	REC8M0080805	8M0080805	KIT CONECTOR TRIM	TRIM CONNECTOR KIT

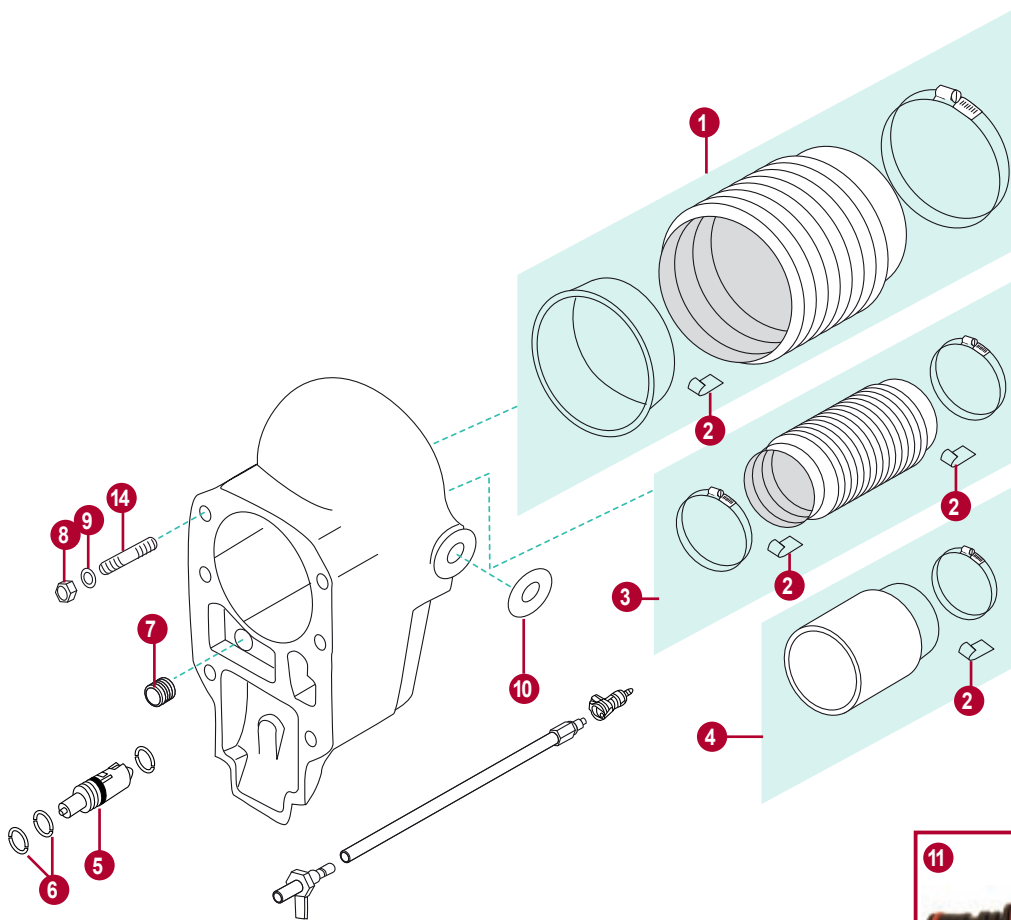

	REF	OEM		
1	REC86840A05	86840A05	FUELLE TRANSON	U-JOINT BELLOW
2	REC54-86049	54-86049	CLIP	CLIP
3	REC18654A1	18654A1	FUELLE ESCAPE	EXHAUST BELLOW
4	REC78458A1	78458A1	TUBO ESCAPE	EXHAUST TUBE
5	REC18920A1	18920A1	VÁLVULA COMPLETA	VALVE ASSEMBLY
6	REC25-48171	25-48171	ARO	O-RING
7	REC41674T	41674T	KIT CASQUILLO	INSERT
8	REC11-34933	11-859116	CIERRE	LOCKNUT
9	REC12-45176	12-35935	ARANDELA	WASHER
10	REC12-72498	12-72498	ARANDELA	WASHER
11	REC22-861150T02	22-861150A1	RACOR ACEITE	OIL RACORD
12	RM22-861163	22-861163	RACOR ACEITE	OIL RACORD
13	REC16755Q1	16755Q1	KIT JUNTAS Bravo & Blackhawk	GASKET SET Bravo & Blackhawk
14	REC16-59579	16-59579	PASADOR	SETTING PIN



**KIT FUELLE**

REF	OEM	
REC60932A4	60932A4 60932A1	1/R/Alpha One (3469428+)



**U-JPINT BELLOWS KIT**

REF	OEM	
REC86840A05	8M0062406 86840A3 86840A05	Bravo & Blackhawk



REF	OEM	
REC36223A2	36223A2 36223 36223A1	Colas antiguas Old styles drives (-3443920)



REF	OEM	
REC816431A1	816431A1	Alpha One Gen II



**CLIP FUELLE**

REF	OEM
REC54-86049	54-86049



**BELLOW CLIP**

**FUELLE DE ESCAPE**

REF	OEM	
REC78458A1	78458A1 78458	Bravo I, II & III



**EXHAUST BELLOWS**

REF	OEM	Ø IN.
REC18654A1	18654A1 32734 32734A3	Alpha & Bravo



**SILEMBLOCK**

REF	OEM		
REC23-99299	23-99299	ESPACIADOR	SPACER
REC12-32834	12-32834	ARANDELA FIBRA	FIBRE WASHER
REC12-35777	12-35777	ARANDELA	WASHER
REC10-97934	10-97934	TORNILLO	SCREW
REC11-863332	11-863332	CIERRE	LOCK
REC13-33734	13-33734	MUELLE	SPRING



**KITS SILEMBLOCK**

REF	OEM
REC865329A02	865329A02



REF	OEM
REC10-97934A1	10-97934A1



REF	OEM
REC21811	



# CAMBIO

# SHIFT

## KIT CABLE CAMBIO

## SHIFT CABLE ASSY KIT

REF	OEM	
REC865436A03	MC1/R/MR/Alpha One/Gen II	



REF	OEM	
REC815471T1	815471T1 Bravo I, II, III	



## ABRAZADERA CABLE

## CABLE CLIP

REF	OEM
REC54-38863	38863
	54-38863
	54-866507
	54-8M0090424
	54-8M0204733
	866507
	8M0090424
8M0204733	



## KIT CAMBIO

## SHIFT LEVER KIT

REF	OEM	
REC45518T1	45518T1 MC-1/R/MR Alpha One / Gen II	



## KIT RETÉN

## SEAL KIT

REF	OEM	
REC23-806036A1	23-806036A1 Alpha One Gen II (F094775+)	



## ACOPLAMIENTOS MOTOR

## ENGINE COUPLER ASSEMBLIES

Se usa en todos los Chevys antiguos en los que el retén trasero del cigüeñal es de dos piezas.

Used on all older Chevy engines with 2 piece rear main seals.



REF	OEM	
REC76850A2	76850A2	GM MR / ALPHA / BRAVO





## POWER TRIM

### LATIGUILLOS POWER TRIM

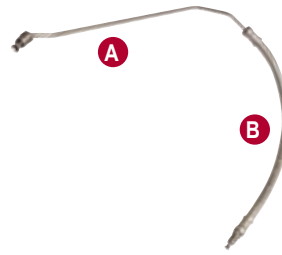

### POWER TRIM HOSES

REF	OEM		
REC32-864960	32-99902-1 32-864960	1/8"	A + B
REC32-864589	32-99902 32-864589		



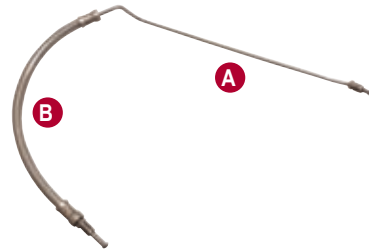

REF	OEM		
REC32-864959	32-99903-1 32-864959	1/8"	A + B
REC32-864588	32-99903 32-864588		





REF	OEM		
REC32-861127	32-861127 32-95858	1/8"	46"
REC32-861128	32-861128 32-95859		



REF	OEM		
REC32-86036	32-86036 32-86036Q	1/8"	14"



REF	OEM		
REC32-99904	32-99904	1/8"	15"



120-140-165-228-250-260-470-485-888-898



REF  
REC21990

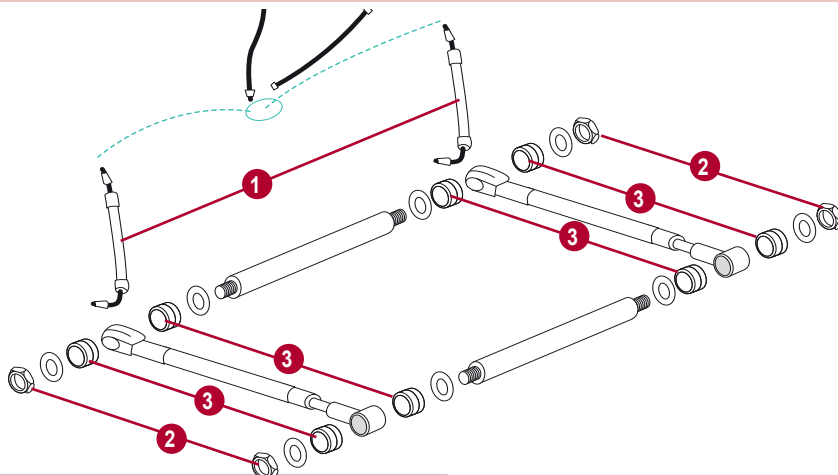

	REF	OEM		
1	REC32-86036	32-86036	LATIGUILLO TRIM	TRIM HOSE
2	REC11-862903	82671013	TUERCA ACERO INOX	LOCK NUT
3	REC23-89574	23-89574	ADAPTADOR GOMA	POWER TRIM RAM BUSHING
4	REC21990	45523 45706A4 77442A1 77443	KIT REPARACIÓN CILINDRO	POWER TRIM CYLINDER SERVICE KIT

R/MR/ALPHA ONE (1983-90)



REF  
REC8M0080805

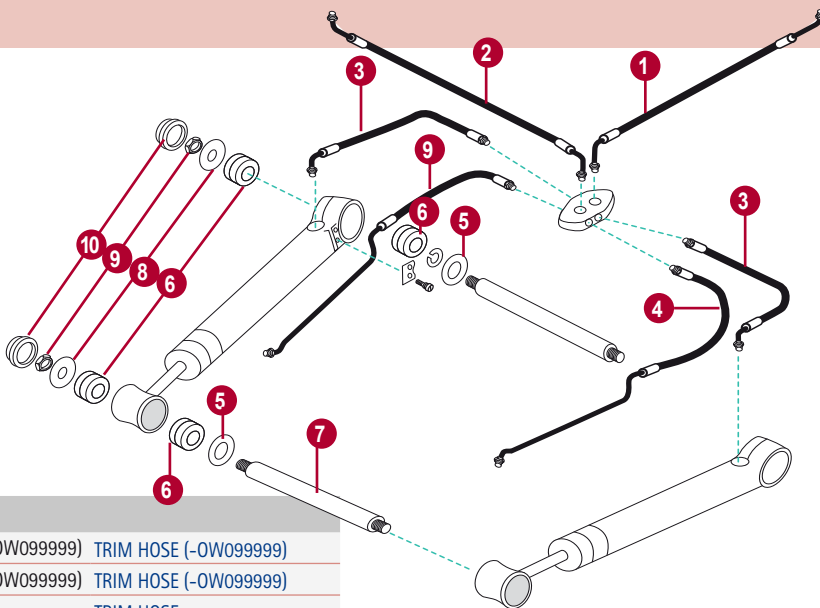

	REF	OEM		
1	REC32-861128	32-861128	LATIGUILLO TRIM (-OW099999)	TRIM HOSE (-OW099999)
2	REC32-861127	32-861127	LATIGUILLO TRIM (-OW099999)	TRIM HOSE (-OW099999)
3	REC32-99904	32-99904Q	LATIGUILLO TRIM	TRIM HOSE
4	REC32-864589	32-864589	LATIGUILLO PARA	TRIM HOSE FOR
	REC32-864960	32-864960	LATIGUILLO PARA	TRIM HOSE FOR
5	REC12-85058	12-85058	ARANDELA	WASHER
6	REC23-99291	23-99291T	ADAPTADOR GOMA	BALL GEAR NUT
7	REC32-864588	32-864588	LATIGUILLO para	TRIM HOSE for
8	REC12-44163	12-44163	ARANDELA	WASHER
9	REC11-34933	11-859116	TUERCA ACERO INOX	LOCK NUT
10	REC19-14842	19-14842	TAPA PLÁSTICO	CAP
11	REC8M0080805	8M0080805	KIT CONECTOR TRIM	TRIM CONNECTOR KIT

Para saber la referencia del pistón debemos revisar el nº grabado en el brazo

Number on cylinder must be checked in order to know piston reference

ALPHA ONE GEN II (1991+)



REF  
REC806191T



REF  
REC8M0080805

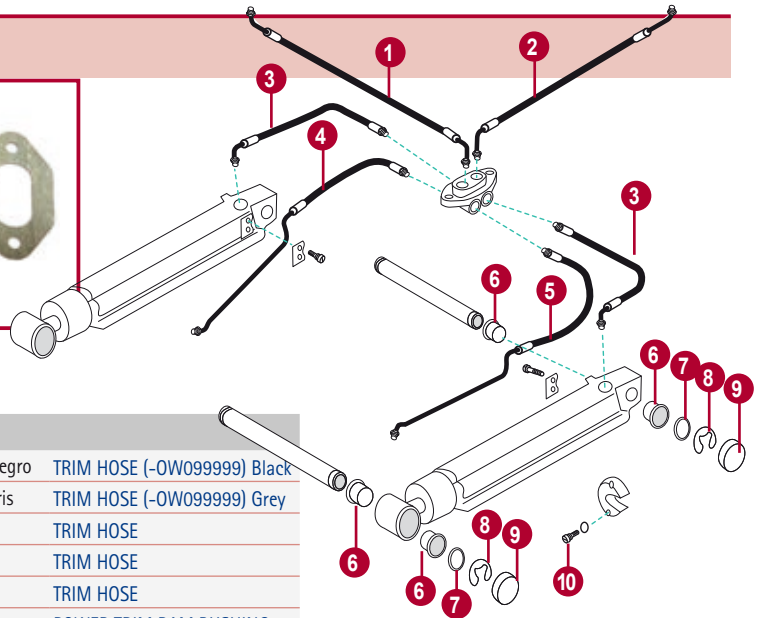

REF	OEM		
1	REC32-861127 32-861127	LATIGUILLO TRIM (-OW099999) Negro	TRIM HOSE (-OW099999) Black
2	REC32-861128 32-861128	LATIGUILLO TRIM (-OW099999) gris	TRIM HOSE (-OW099999) Grey
3	REC32-99904 32-99904Q	LATIGUILLO TRIM	TRIM HOSE
4	REC32-864959 32-864959	LATIGUILLO TRIM	TRIM HOSE
5	REC32-864960 32-864960	LATIGUILLO TRIM	TRIM HOSE
6	REC23-8159501 23-8159501	CASQUILLO	POWER TRIM RAM BUSHING
7	REC12-815952 12-815952	ARANDELA	WASHER
8	REC53-815949 53-815949	CIERRE METÁLICO	E-RING
9	REC19-815951 19-815951	TAPA PLÁSTICO	PLASTIC CAP
10	REC10-806290 10-806290	TORNILLO	SCREW
11	REC806191T 806191T	TAPÓN CILINDRO POWER TRIM Ø 48 MM (EXT)	POWER TRIM RAM END CAP Ø 48 MM (EXT)
12	REC8M0080805 8M0080805	KIT CONECTOR TRIM	TRIM CONNECTOR KIT

BRAVO



REF  
REC806191T



REF  
REC25-87400A2

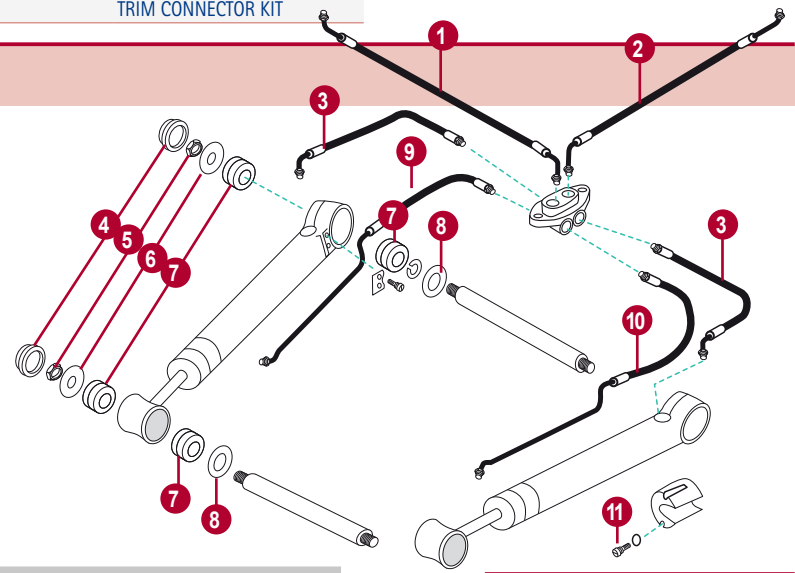

REF	OEM		
1	REC32-861127 32-861127	LATIGUILLO (-OW099999) Negro	TRIM HOSE (-OW099999) Black
2	REC32-861128 32-861128	LATIGUILLO (-OW099999) gris	TRIM HOSE (-OW099999) Grey
3	REC32-99904 32-99904Q	LATIGUILLO TRIM	TRIM HOSE
4	REC19-14842 19-14842	TAPA PLÁSTICO	PLASTIC CAP
5	REC11-34933 11-859116	TUERCA INOX	LOCK NUT
6	REC12-44163 12-44163	ARANDELA	WASHER
7	REC23-807073 23-807073	ADAPTADOR GOMA P.T.	P.T. RAM BUSHING
8	REC12-44164 12-44164	ARANDELA	WASHER
9	REC32-864588 32-864588	LATIGUILLO TRIM	TRIM HOSE
10	REC32-864589 32-864589	LATIGUILLO TRIM	TRIM HOSE
11	REC10-806290 10-806290	TORNILLO	SCREW
12	REC806191T 806191T	TAPÓN CILINDRO Ø 48 MM (EXT)	RAM END CAP Ø 48 MM (EXT)
13	REC25-87400A2 25-87400A2	KIT RETENES	POWER TRIM SEAL KIT
14	REC21920	KIT EJE SUJECCIÓN DELANTERO	POWER TRIM RAM BUSHING KIT (FRONT)
15	REC8M0080805 8M0080805	KIT CONECTOR TRIM	TRIM CONNECTOR KIT



REF  
REC21920



REF  
REC8M0080805

## HERRAMIENTAS

## TOOLS

### EXTRACTOR POLEA BOMBA DE DIRECCIÓN

### PULLEY REMOVER, DRIVE PUMP

REF

REC91-25034



### CENTRADOR MOTOR

### ENGINE ALIGNMENT TOOL

Centra el motor y la cola durante la instalación.

Aligns engine and drive unit during installation.

REF

OEM

REC91-805475A1 91-805475A1



### LLAVE TORNILLO LATERAL TRANSOM

### HINGE PIN TOOL

Instala y desinstala los tornillos laterales de las colas.

Removes and installs hinge pins from drive units.

REF

OEM

REC91-78310 91-78310



### LLAVES PARA ELEMENTOS DEL CAMBIO

### TOOLS FOR ELEMENTS TO DRIVESHAFT

Llave montaje y desmontaje casquillo sujeción tubo de agua.

Drive shaft adapter.

REF

OEM



REC91-43579 91-43579 Bravo I, II & III



Llave cable cambio. Para montaje y desmontaje de los cables de cambio en las colas. Shift cable tool. Installs and removes drive shaft bearing retainer on drive units.

REF

OEM



REC91-12037 91-12037 MC-I, R-MR, Alpha One, Gen II.



Llave montaje casquillos eje cambio.

Bushing removal tool.

REF

OEM



RM91-17273 91-17273 Bravo I, II & III



### LLAVE TUERCA CARDAN

### BEARING RETAINER WRENCH

REF

OEM



REC91-17256 91-17256 MC-I, R-MR, Blackhawk, Alpha y Bravo.



EXPANSOR DE FUELLES

BELLOWS EXPANDER TOOL

REF	OEM	
REC91-45497A1	91-45497A1	MC-1/R/MR Alpha One/Alpha One Gen II Bravo, Et Blackhawk



ÚTIL INSTALACIÓN ANILLO DE FUELLE

BELLOWS RING INSTALLATION TOOL

REF	OEM	
REC91-818162	91-818162	Alpha Gen II Et Bravo



SISTEMA DE PROPULSIÓN

PROPULSION SYSTEM

NÚCLEO DE HÉLICE

HUB KIT

REF	OEM	
REC835257K12	835257K12	



REF	OEM	
REC8M0101601	8M0101601 8M0101603	



KIT CIERRE DE HÉLICE

PROP LOCK KIT

REF	OEM	
REC11-69578Q1	11-69578/ A1/ Q1 69578A1/Q1/T1	40 HP, 70 HP



OEM --> REF

OEM	REF	OEM	REF	OEM	REF
7358	REC938-7499	216	60565	154	804424
11973	REC59341A1	219	60930	224-242	805100
12449	REC3860769	177	62092	157	805218
12708	REC12708	256	63196	158	805223
13037	REC13037	179	67202	220	805884
14241	REC27-14241	217	69729	177	806188
14259	REC809910	220	69887	221	806188
15961	REC13001	221	71327	158	806490
16012	REC32-16012	205	71646	158	806609
17464	REC11001	221	72778	197	807134
17464	REC11004	221	73379	230-232	807652
19685	REC3860769	177	75832	256	807653
20195	REC339543	220	76214	261	808033
20365	REC310584	220	76214	261	808483
26855	REC3852928	220	77123	265	808484
27018	REC326649	220	77443	273	808504
30224	REC326649	220	77594	158	809064
31305	REC553126	220	78402	177	809065
32509	REC304174	220	78458	270	809910
32734	REC18654A1	270	78485	158	809992
33466	REC302537	220	78820	158	810845
33756	REC305123	220	79223	219	810850
34127	REC34127T2	261	82138	179	810852
34127	REC34127T2AL	261	85691	221	811091
34510	REC10501	216	85701	221	811461
34532	REC12001	216	85704	221	811534
34623	REC8M0068784	171	85705	221	811636
34625	REC97258A1	172	85803	218	811637
35029	REC25-35029	220	86234	158	811639
35276	REC310584	220	86246	158	814622
35323	REC13508	218	86247	158	815425
35330	REC12001	216	87284	218	816607
35937	REC16-59579	276	87824	218	817119
36223	REC36223A2	270	89718	205	817377
36318	REC301967	220	89961	276	817378
36525	REC806490T	172	90806	171	818465
38191	RM733-810852	221	94286	261	818467
38547	REC1463-9382	181	94286	261	821509
38863	REC54-38863	271	94288	219	823728
39695	REC326849	220	94576	197	824317
41471	PAGB/T93-10	230	97258	172	827682
41802	REC41802	226-229-230-231-235-237-263-267	97335	219	828151/A1
42750	REC59341A1	219	97387	219	835076
43557	REC805759Q01	184	97399	157	846361
43713	REC43713	263-267	97401	158	846361
43994	REC821631Q1	262	97661	218	850484
43994	REC821631Q1AL	262	97661	218	850485
45523	REC21990	273	98555	177	850487
45711	REC326649	220	99757	230	853678
46335	REC46335	222-223-224-225-229-233-235-237	99948	216	854445
46399	REC46399	261	201951	220	859135
46399	REC46399AL	261	309955	276	859210
46860	REC86247T	158	479452	226	859892
47585	REC86234A4	158	668631	230-232	859893
47820	REC47820A1	261	802018	220	860231
47820	REC47820A1AL	261	802028	276	861249
48952	REC48952	172	802030	276	861578
49107	REC17985	214	802037	220	862031
49953	REC27-49955	220	802039	220	862998
49955	REC27-49955	220	802045	276	863725
52221	REC13001	221	802149	220	863786
52224	REC13002	221	802149	220	864148
52225	REC13024	221	802151	220	864297
52367	REC13501	218	802231	220	864493
52550	REC17985	214	802251	220	864572
53051	REC27-53045Q01	192	802257	220	865182
54552	REC62092T	157	802258	220	865182
54799	REC59341A1	219	802350	184	865193
56045	REC69729	177	802357	184	865598
58034	REC64851	184	802383	220	866507
58203	REC8540013	217	802416	153	878187
58284	REC12001	216	802464	182	878990
58390	REC909140	220	802555	218	879172
59341	REC59341A1	219	803148	169	881698
59579	REC16-59579	276	803149	170	881715
59755	REC69729	177	804412	182	881731
			804418	183	882376
			REC35-06007		REC3854311
			REC60930		REC805100
			REC62092T		REC3850397
			REC86247T		REC805223T
			REC313175		REC805884T
			REC69729		REC806188Q01
			REC13018		REC806188Q01AL
			REC86234A4		REC806490T
			REC86246T		REC304174
			REC94576		REC25-8071341
			REC22-73379		REC807652T
			REC3850812		REC807653T
			REC76214T1		REC32-808033
			REC76214T1AL		REC3854548
			REC77123		REC3854549
			REC21990		REC65L-13915-00
			REC86234A4		REC809064
			REC78403A2		REC809065
			REC78458A1		REC809910
			REC86246T		REC13507
			REC86247T		RM810845
			REC59341A1		REC13501
			REC3854138		RM733-810852
			REC13018		REC806490T
			REC13001		REC27-8M0094247
			REC13002		REC811534
			REC13024		REC3854261
			REC13502		REC3854003
			REC86234A4		REC3854001
			REC86246T		REC8540013
			REC86247T		REC8M0068784
			REC13502		REC816607
			REC13502		REC3860769
			REC32-897181		REC817377
			REC314502		REC3854002
			REC8M0068784		REC13012
			REC94286T1		REC13013
			REC94286T1AL		REC882751A04
			REC25-94288		REC809065
			REC94576		REC13502
			REC97258A1		REC827682T
			REC59341A1		REC3854138
			REC25-97387		REC809065
			REC862048A1		REC326649
			REC8M0058164		REC326849
			REC13504		REC3854331
			REC13506		REC3854311
			REC3860769		REC3854003
			REC27-99757		REC853678T
			REC12001		REC854445
			REC339543		REC11-859135
			REC309955		REC881879T11
			PAF15-07010004		REC315810
			REC10-668631		REC315810
			REC307450		REC27-8637251
			REC314502		REC861249A1
			REC315810		REC861578
			REC318717		REC862031T1
			REC319085		REC862998
			REC320785		REC27-8637251
			REC909048		REC22-863786A1
			REC909139		RM21325765
			REC909140		REC864297T01
			REC25-35029		REC864493
			REC313754		REC864572
			REC314491		REC865182Q01
			REC314728		REC865182Q02AL
			REC0580256		REC865193
			REC0581419		REC8M6500024
			REC910238		REC54-38863
			REC984491		REC8M6003194
			REC3854003		REC3852476
			REC802555		REC879172
			REC803148		REC15-808
			REC3843751		REC27-14241
			REC3854003		REC8M0054726
			REC3854548		REC882376

OEM	REF	OEM	REF	OEM	REF
882613	REC25-35029	220	10-43749	REC10-43749	226-229-231-235-237
882687	REC882687	156	10-53728	REC10-53728	223-224-226-229-231-235
883297	REC938-803860T	216	10-668631	REC10-668631	223-224
884727	REC46-8M0113733	195	10-74727	REC22-73379	225
884790	REC898253013	184	10-79953Q04	REC10-79953Q04	245-251-253
884792	REC898253T22	184	10-806290	REC10-806290	274
885165	REC8M0087834	169	10-816601	REC10-816601	251-253-259
885176	REC885176	162	10-824941	RM10-25299	222-223-225-233
888731	REC898253T23	184	10-861788	REC10-861788	175-176
889341	REC8M0098619	168	10-86801	REC10-86801	265-269
892617	REC892617	171	10-97934	REC10-97934	270
892665	REC35-892665	161	10-97934A1	REC10-97934A1	264-270
892681	REC892681	161-162	11-134371	REC11-862903	265-269
892683	REC26-892683	161	11-134391	REC11-34933	266
895207	REC895207	156-194	11-22339	REC11-22339	245-251-253-256
896523	REC25-94288	219	11-34933	REC11-34933	263-267
897181	REC32-897181	205	11-46335	REC46335	238
898141	REC3863130	170-187	11-52707Q1	REC11-52707Q1	247-249-255-257
1596110	REC13002	221	11-69578/A1/Q1	REC11-69578Q1	276
1596120	REC13024	221	11-859116	REC11-34933	245-247-249-259-268-273-274
3322070	REC32-33220	205	11-859135	REC11-859135	253
3349198	REC15000K	199	11-863332	REC11-863332	270
3853825	RM3853825	272	12-19183-3	REC12-191833	259
3854260	REC3854260	186	12-191833	REC12-191833	245-247-249-256-257-258
3854331	REC3854331	186	12-20084	REC12-20084	198-222-223-224
3854548	REC3854548	186	12-32666	REC12-32666	245-266
3916720	REC15000K	199	12-32834	REC12-32834	270
8018611	REC11004	221	12-35777	REC12-35777	270
8079821	REC27-8079821	164	12-35935	REC12-45176	251-253-266-268
8084841	REC3854549	184	12-41721	RM12-41721	265-269
8085041	REC65L-13915-00	154	12-44163	REC12-44163	273-274
8116361	REC3854261	184	12-44164	REC12-44164	274
8172761	REC8172761	255	12-45176	REC12-45176	259
8183812	REC8M0113182	204	12-45810	REC12-45810	245-251-253
8243171	REC13505	218	12-72498	REC12-72498	268
8503991	REC46-8M0113734	195	12-815472	REC12-815472	264
8504851	REC3854311	184	12-815952	REC12-815952	274
8623405	REC86234A4	158	12-85058	REC12-85058	273
8733261	REC13037	179	12644A1	REC12644A1	243
8818793	REC8M6000623	172	13-33734	REC13-33734	270
11992001	REC13010	221	13-35048	REC13-35048	223-224-225-226-229-231-233-235-237-238-256
14358001	REC32-14358001	230	13-39107	REC13-39107	225
44348001	REC32-44348001	230	13-41471	PAGB/T93-10	224
81637002	REC3854003	182	13-42351-1	REC13-423511	247-257
82671013	REC11-862903	273	13-423511	REC13-423511	249-255
85726001	REC13019	221	1347-6492A1	REC1347-816373A4	163
801331174	RM21325765	168	1347-7362A1	REC1347-816373A4	163
801763272	RM21325765	168	1347-804624R02	REC1347-816373A4	163
811637001	REC3854003	182-186	1347-816373A4	REC1347-816373A4	163
811858001	REC13011	221	1347-8292A4	REC1347-816373A4	163
854179001	REC8M0148530	196	1347-9415T	REC1347-816373A4	163
864297001	REC864297T01	171	1347-9662A4	REC1347-816373A4	163
879172105	REC3843100	172	13524A1	REC13524A1	184
879172151	REC895207	194	13524A4	REC13524A4	184
879194185	REC879194185	194	13524A5	REC13524A1	184
879194215	REC8M0093561	192	13524A6	REC13524A6	184
879194231	REC8M0093561	192	13524Q06	REC13524A6	184
879194233	REC8M0093561	192	13524T1	REC13524A1	184-187
879312023	REC8M0148530	196	13753A2	REC815407A2	184-187
881693002	REC881693002	162	13840A1	REC15353	220
881879010	REC8M6000623	172	1389-9562A1	REC3310-860070A2	163
881879011	REC881879T11	171	1396-4656	REC1396-4656	165
885342001	REC8M0148668	173	1396-5222	REC1396-5238	165
885342002	REC8M0148668	173-230-232	1396-5238	REC1396-5238	165
889659002	REC8M6000634	171	1397-2067	REC823427A1	165
896332057	REC896332057	204	1397-2634	REC823427A1	165
896332148	REC8M0093561	192	1397-3459	REC823427A1	165
896332162	REC879172	156	1397-5837	REC3302-9031	162
897345016	REC8M0155633	196	1397-6367A1	REC1397-6367A1	165
897447002	REC8M6000634	171	1397-7542/7	REC823427A1	165
898101425	REC8M0111642	204	1397-8872/3	REC823427A1	165
898253010	REC3854549	184	14348A1	REC807166A3	242
898253011	REC3854261	184	16-49545	REC16-49545	222-225-229-233-235-237-238
898253012	REC3854311	184	16-59579	REC16-59579	266-268-276
898253013	REC898253013	184	16-70236	REC16-70236	222-223
10-28636	REC10-28668	263	16-806300	REC16-806300	224
10-28668	REC10-28668	245-253-251			
10-32470	REC10-32470	247-249			
10-34510	REC10501	216			
10-37612	REC10-37612	237-238			
16457A4	REC805759Q01	184			
16755Q1	REC16755Q1	268-269			
16755Q1	REC86310	256			
16792A39	REC16792A39	264			
17-35973	REC331880	249			
17-8M0073409	REC17-8M0073409	267			
18-32665	REC18-32665	245-266			
18-82132M	REC314502	276			
18-89961	REC314502	276			
18654A1	REC18654A1	266-268-270			
18920A1	REC18920A1	266-268			
19-14842	REC19-14842	273-274			
19-815951	REC19-815951	274			
19-864689	REC19-864689	226-231			
19405A4	REC13524A6	184			
19674A07	REC19674A07	180			
19742A1	RM806193A48	194			
19742A3	RM806193A48	194			
22-328022	REC22-328022	223-229-235-237-238			
22-36382	REC22-36382	222-223-229-235-237			
22-41622	REC22-41622	223-229-233-235-237-238			
22-73379	REC22-73379	226-229-231-235-237-263			
22-806608A1	REC13980	222-223-224			
22-861150A1	REC22-861150T02	194-266-268			
22-861150A2	REC22-861150T02	194			
22-861150T02	REC22-861150T02	194			
22-861163	RM22-861163	194-266-268			
22-862210A01	REC862210A01	226-227-229-235-237			
22-862225	REC22-862225	191			
22-863786A1	REC22-863786A1	231			
22-863786A1	REC22-863786A1	226			
23-11992	REC13010	221			
23-11992001	REC13010	221			
23-29804T	REC23-29804T	247-249			
23-30617A2	REC23-30617A2	247-249			
23-804982	RM23-804982	221			
23-806036A1	REC23-806036A1	266-271			
23-806922	REC23-806922	191			
23-807073	REC23-807073	274			
23-811858	REC13011	221			
23-811858001	REC13011	221			
23-815921A21	REC23-815921A21	255			
23-8159501	REC23-8159501	274			
23-816583	REC23-816583	255			
23-818465	REC13012	221			
23-818467	REC13013	221			
23-847637	REC23-847637	265-269			
23-847638	RM23-847638	269			
23-85691	REC13018	221			
23-85701	REC13001	221			
23-85704	REC13002	221			
23-85705	REC13024	221			
23-85726001	REC13019	221			
23-89574	REC23-89574	273			
23-98356	RM23-98356	263-267			
23-983571	RM23-983571	263-267			
23-99291T	REC23-99291T	273			
23-99299	REC23-99299	270			
24-8M0094247	REC27-8M0094247	168			
25-201951		220			
25-20826	REC308627	219-257-258-259			
25-21836	REC25-21836	219-255			
25-23145	REC125017	219			
25-25439	REC25-25439	219-245-247-249-251-253			
25-26722	REC302588	219			
25-26802	REC25-8M0084884	195			
25-26802	REC303347	219			
25-26855	REC3852928	220			
25-30224	REC25-30224	192			
25-30224	REC326649	220			
25-30224Q	REC25-30224Q	219			
25-30613	REC25-30613	219-247-249			
25-31305	REC553126	220			
25-31534	REC25-31534	247-249-255-257			
25-31986	REC3852866	219			
25-32509	REC304174	220			
25-32546	REC25-32546	219-245-251-253			

OEM	REF		OEM	REF		OEM	REF	
25-33145	REC25-33145	219-247	26-805344	REC26-805344	257-258-259	27-815528	REC27-815528	224-243
25-33465	REC25-33465	198-219-257-259	26-807006	REC26-807006	219-256	27-815528	REC27-815528	224
25-33466	REC302537	220	26-811554	REC26-811554	217	27-8172771	REC27-8172771	255
25-33504	REC0307239	219-266	26-814622	RECB540013	217	27-818832	REC27-863726	241
25-33756	REC305123	220	26-816464-1	REC26-8164641	255	27-85046	REC27-850456	217
25-34821	REC25-34821	258	26-8164641	REC26-8164641	219-247-249	27-854129	REC27-8M0094247	168
25-35027	REC25-35027	251-253-256	26-816575A2	REC26-816575A2	255	27-856081	REC27-856081	247-249
25-35029	REC25-35029	220	26-816575A3	REC26-816575A3	255	27-856704	REC27-856704	247
25-35276	REC310584	220	26-821092	REC26-821092	219	27-856705	REC27-856705	225-241
25-36318	REC25-36318	255	26-8219471	REC26-8219471	217	27-858524	REC27-858524	247-249
25-36318	REC301967	220	26-823894	REC26-823894	219-245-251-253	27-860232	REC27-863726	241
25-39695	REC326849	220	26-861694	REC26-861694	259	27-860233	REC27-863724Q	241
25-39695	REC326649	220	26-864319	REC26-864319	253-255	27-863724	REC27-863724Q	241
25-45253	REC304174	220	26-88397	REC26-88397	251-253	27-863724Q	REC27-863724Q	229-235-237-241
25-457101	REC25-457101	219-256	26-88397A1	REC26-88397A1	251-253	27-8637251	REC27-8637251	229-235-237-241
25-45711	REC326649	220	26-88416	REC26-88416	263-267	27-863726	REC27-863726	229-235-237-241
25-47254	REC310414	219	26-89238	REC26-89238	219-247-249	27-864547A02	REC27-864547A02	242
25-47632	REC0554545	219	26-892683	REC26-892683	161	27-864547A02	REC270	226-231-241
25-48171	REC25-48171	219-266-268	26-8M0033407	REC26-8M0033407	259	27-864549A02	REC270	226-231-241
25-48452	REC302035	219	26-8M0050563	REC70817B	218	27-864549A02	RM27-864549A02	242
25-54029	REC25-33465	219	26-8M0150312	REC26-8M0150312	218	27-864550A02	REC270	241-226-231
25-55682	REC26-55682	219-263	26-90562	REC26-90562	198-219	27-864850A02	REC27-864850A02	242
25-55801	REC25-55801	219-245	26-965031	REC26-965031	219-245	27-871051	REC27-863726	241
25-58390	REC909140	220	26-97335	REC59341A1	219	27-881715	REC27-14241	217
25-62704	REC3852045	219	26-97664	REC70817B	218	27-883964T	REC27-14241	217
25-65936	REC331188	219	26-976641	REC70817B	218	27-89656-1	REC27-89656-1	192
25-67202	REC25-67202	219	27-14241	REC27-14241	217	27-896561	REC27-89656-1	225
25-67202	REC313175	220	27-14250	REC27-14250	217	27-898101475	REC27-8M0094247	168
25-70937	REC25-70937	219-245-251-253	27-18272	REC27-18272	225-241	27-8M0077608	REC27-49955	220
25-805331	REC3852865	219-259	27-33179Q02	REC27-33179Q02	192	27-8M2021920	REC27-33918	192
25-8071341	REC25-8071341	192	27-33395	REC27-33395	231-233-235-238-243	27-94914	REC27-94914	198
25-8071341	REC25-8M0084884	195	27-33956	REC27-33956	197	27-94996Q2	REC27-94996Q2	251-253-266-269
25-822370	REC25-33465	257-258	27-34213	REC27-34213	158	27-96429	REC27-96429	223-243
25-87400A2	REC25-87400A2	274	27-34486-3	REC27-344861	187	27-97542	REC27-856705	241
25-89633	REC32126	195	27-34897	REC27-34897	197	27-988231	REC27-988231	263-267
25-896332077	REC32077	194	27-34898	REC27-34898	158	27-995061	REC27-995061	263
25-896332126	REC32126	195	27-39915	REC27-39915	239-241	27-99757	REC27-99757	226-227-229-243
25-8M0039163	REC25-8M0084884	195	27-40431	REC27-40431	238	27-997771	REC27-99777Q02	241
25-8M0204651	REC326649	220	27-41812	REC27-41812Q	192	27-997772	REC27-99777Q02	241
25-90011	REC25-90011	219-249-255	27-41812Q	REC27-41812Q	192	27-99777Q02	REC27-99777Q02	222-223-224-225-233-238-241
25-94288	REC25-94288	219	27-41813	REC27-863724Q	241	28-161551	REC28-161551	197
25-97387	REC25-97387	219	27-42457	REC27-42457	158	28-8M0032833	REC28-8M0032833	255
26-12224	REC26-12224	219-247-249-255	27-42631-1	REC27-426311	249	30-72961	REC30-72961	198
26-12709	REC26-12709	219-256	27-430331	REC27-430331	255	30-879194A01	REC30-879194A01	263-267
26-14077	REC26-76868	219-255	27-46820	REC27-46820	237-238-243	30-88957T	REC30-88957T	247-249
26-14240	REC26-14240	217-219	27-47510Q	REC27-47510Q	192	30-88957T1	REC30-88957T	255
26-14756	REC26-14756	217	27-47590-1	REC27-475901	192	300-8M0044991	REC300-8M0044991	181
26-16709A2	REC26-16709A2	256	27-48042	REC27-48042	238-241	30224Q	REC326649	220
26-16977	REC26-16977	219-247-249	27-480431	REC27-480431	222-225-233-238-242	31-30956T	REC387247	247-249-255
26-32511	REC26-32511	219-245	27-48399	REC27-48399	164	31-32575T1	REC31-32575T1	245-253-251
26-32511A1	REC26-32511A1	245	27-48818Q01	REC27-48818Q01	192	31-35988A12	REC31-35988A12	245-251
26-33144A2	REC26-33144A2	247-249	27-49110	REC27-49110	197	31-42647A1	REC387817	249-255
26-34217	REC26-34217	218	27-49953	REC27-49953	217	31-61100A1	REC31-61100A1	245-251
26-36556	REC26-36556	257-258	27-49955	REC27-49955	220	31640Q4	REC31640Q4	261
26-36557	REC26-36557	245	27-524572	REC27-524572	164	31640Q4	REC31640Q4AL	261
26-38970	REC26-38970	247-249	27-52546	REC27-52546	239-243	32-14358	REC32-14358001	243
26-416071	REC26-8M2005029	263-267	27-52550	REC17985	214	32-14358001	REC32-14358001	226-227-229-231-235-237-243
26-41953	REC26-41953	219	27-53045Q01	REC27-53045Q01	192	32-14358T	REC32-14358001	243
26-43035	REC26-43035	219	27-53354	REC27-53354	222-243	32-16012	REC32-16012	205
26-43036	REC26-43036	219	27-55810 1	REC27-558101	245	32-32461	REC32-32461	205-263-266
26-43993	REC26-43993	219-256	27-60715	REC27-60715	164	32-32461A1	REC32-32461	205
26-45577 1	REC26-455771	219-247-249	27-64692	REC27-64692	164-222-223	32-33189	REC32-33189	205
26-45577-1	REC26-455771	255-259	27-64718A1	REC27-64718A1	245	32-33220	REC32-33220	205
26-455771	REC26-455771	257-258	27-65577	REC27-65577	164	32-3322070	REC32-33220	205
26-54925	REC26-54925	263	27-68714	REC27-68714A6	217	32-3322070	REC32-4172533	205-263-266
26-56397	REC26-56397	219	27-68715	REC27-68715	216-225-243	32-4172533	REC32-4172533	205-263-266
26-64818Q4	REC27-64818Q4	245-266-269	27-701431	REC27-701431	164	32-43437	REC32-43437	205-267
26-66302	REC26-66302	219-251-253-255	27-72805	REC27-72805	158	32-44348	REC32-44348001	243
26-69188	REC26-69188	219	27-73666	REC27-73666	216	32-44348001	REC32-44348001	227-229-231-235-237-243
26-69189	REC26-69189	219	27-73866	REC3852455	238-243	32-44348T	REC32-44348001	243
26-70081	REC26-70081	219	27-74830	REC27-74830	192	32-54236	REC32-54236	245
26-72785	REC26-72785	198-219	27-801333454	REC27-8M0094247	168	32-55483	REC32-33220	205
26-75413	REC26-75624	218	27-8052151	REC27-8052151	198	32-808033	REC32-808033	205
26-75624	REC26-75624	216-218	27-805760	REC27-805760	187	32-860220	REC32-860220	251-253
26-75988	REC26-75988	218	27-807218	REC27-807218	222-223-225-242	32-86036/Q	REC32-86036	272-273
26-76868	REC26-76868	219-247-249-257-258	27-807982	REC27-807982	164	32-861127	REC32-861127	272-273-274
26-76868A04	REC26-76868A04	257-258-259	27-8079821	REC27-8079821	164	32-861128	REC32-861128	272-273-274
26-79831	REC321466	219	27-8079821	REC27-8079821	164-223-224	32-864588	REC32-864588	272-273-274
26-804507	REC26-8M0150312	218	27-8146801	REC27-8146801	192	32-864589	REC32-864589	272-273-274
26-805080	REC26-861694	219						

OEM	REF		OEM	REF		OEM	REF	
32-864959	REC32-864959	272-274	39-17464	REC11004	221	50-8M0095471	REC50-8M0095471	175
32-864960	REC32-864960	272-273-274	39-801861	REC11004	221	50-99417A2	REC50-99417A2	176
32-87117/1	REC32-871171	205	39-801861T	REC11004	221	50-99418A2	REC50-99418A2	175
32-88795	REC32-88795	205	39-827651T	REC13019	221	53-29641	REC53-29641	249-255
32-897181	REC32-897181	205	392-7803A4	REC300-00879	181	53-815949	REC53-815949	274
32-8M0062102	REC8M0062102	205-267	392-805570A2	REC300-00879	181-187	54-38863	REC54-38863	271
32-8M0062309	REC32-4172533	205	392-806529A1	REC1463-9382	181	54-86049	REC54-86049	266-268-270
32-8M0062614	REC32-33220	205	392-863704T	REC3861985	181	54-866507	REC54-38863	271
32-95858	REC32-861127	272	392-881732	REC3861267	181	54-896332164	RM21325765	168
32-95859	REC32-861128	272	392-889925	REC3859078	181	54-8M0090424	REC54-38863	271
32-99902	REC32-864589	272	392-8M0054588	REC3861985	187	54-8M0204733	REC54-38863	271
32-99902-1	REC32-864960	272	392-9766	REC392-9766	183	55989Q9	REC55989Q9	262-263
32-99903	REC32-864588	272	392-9766Q1	REC392-9766	183	55989Q9	REC55989Q9AL/M	262
32-99903-1	REC32-864959	272	392-9766T	REC392-9766	183	56-90415A24	REC16-59579	276
32-99904	REC32-99904	272	393-3230	REC393-9459Q1	183	57-13457Q	REC57-13457Q	205
32-99904Q	REC32-99904	274-273	393-4988T/2	REC393-9459Q1	183	57-13458Q	REC966931	205
32193A2	REC1463-9382	181	393-9459Q1	REC393-9459Q1	183	57-32850	REC3852106	205
32734A3	REC18654A1	270	41141A2	REC862077A1	157	57-34359	REC57-34359	205
3302-804689	REC3302-804689	166	41674T	REC41674T	267-268	57-37619Q	REC57-34359	205
3302-804844002	REC3302-804844002	166	42121Q02	REC42121Q02/AL	261	57-37619T	REC57-34359	205
3302-804845	REC3302-804845	166	42419A1	REC42419A1	178	57-45856	REC3858462	205
3302-9031	REC3302-9031	162	42724A3	REC42724A3	245	57-48120Q1	REC829207	205
3302-9437	REC3302-804845	166	43-75325A3	REC43-75325A3	245-251	57-48122Q	REC57-48122Q	205
3310-804624R1	REC1347-816373A4	163	43557A1	REC805759Q01	184	57-49043A1	REC57-49043A1	205
3310-806077A2	REC3310-860070A2	163	44-850308	REC44-850308	255	57-49213A1	REC3858462	205
3310-806078A2	REC3310-860070A2	163	45518T1	REC45518T1	266-271	57-64032Q1	REC57-49043A1	205
3310-815396A2	REC3310-860070A2	163	45706A4	REC21990	273	57-65607T	REC57-65607Q	205
3310-860070A2	REC3310-860070A2	163	46-44292Q03	REC46-44292Q03	200-249	57-69143Q	REC3852106	205
3310-861245A1	REC3310-864943A01	163	46-60367A1	REC46-96148A8	201	57-74271Q	REC966903	205
3310-861448A1	REC3310-864942A01	163	46-72774A69	RM46-807151A8	196	57-77274	REC966900	205
3310-864941A01	REC3310-864941A01	163	46-807151A14	REC46-807151A14	198	57-78200Q1	REC57-78200Q1	205
3310-864942A01	REC3310-864942A01	163	46-807151A8	RM46-807151A8	196	57-807755Q05	REC57-807755Q05	204
3310-864943A01	REC3310-864943A01	163	46-807151A9	REC46-807151A9	196	57-816295Q	REC57-816295Q	205
3310-9350A2	REC3310-860070A2	163	46-862914T10	REC46-862914T10	196	57-861757Q	REC57-861757Q	204
3310-9562A1	REC3310-860070A2	163	46-879194401	REC46-879194401	196	57-861758Q	REC57-861758Q	204
34762A1	REC34762A1	262	46-96148A5	REC46-96148A8	201	57-865615Q01	REC57-865615Q01	204
34762A1	REC34762A1AL	262	46-96148A8	REC12120	200-249	57-865615Q03	REC57-865615Q03	204
35-11004A1	REC35-8M0046752	153	46-96148A8	REC46-96148A8	201	57-865615Q04	REC57-865615Q04	204
35-16595Q	REC3850559	154-156	46-96148T1	REC46-96148T1	247-249	57-865615Q06	REC57-865615Q06	204
35-16595T1	REC3850559	156	47-43026Q02	REC47-43026Q02	199-255	57-865615Q08	REC57-865615Q08	204
35-19485	REC127695-35150	156	47-43026Q06	REC47-43026Q06	199	57-879172120	REC57-879172120	204
35-19487	REC127695-35150	156	47-59362Q01	REC47-59362Q01	198-199	57-879194425	REC57-879194425	204
35-49088A2	REC35-49088A2	153	47-59362T6	REC47-59362T6	197	57-898101579	REC57-898101579	204
35-49088Q2	REC35-49088A2	153	47-801332602	REC3841697	199	57-898101624	REC57-879194425	204
35-52731	REC3850559	156	47-809866T	REC47-809866T	199	57-8M0074767	REC57-8M0097728	204
35-802886Q	REC35-06007	154	47-816814T	REC3593573	199	57-8M0088876	REC57-8M0088876	204
35-803470	REC3517857	156	47-831311350	REC47-809866T	199	57-8M0093495	REC57-8M0093495	204
35-803897Q1	REC35-8M0046752	153	47-853126	REC15000K	199	57-8M0097728	REC57-8M0097728	204
35-80470Q	REC3517857	156	47-862232A2	REC47-862232A2	199	57-93658Q	REC3858462	205
35-805312	REC35-805312	156	47-879194186	REC17937-0001	199	59078Q3	REC59078Q3	192
35-807256T	REC35-807256	155	47-879312025	REC10615K	199	59341A1	REC59341A1	219
35-850481	REC500MA	155	47-896332063	REC11979-0001	199	59362T6	REC47-59362T6	197
35-850481A1	REC500MA	155	47-89984Q5	REC47-89984Q5	200-247-249	60932A1	REC60932A4	270
35-864572	REC864572	153	47-89984Q5	REC864572	199	60932A4	REC60932A4	266-270
35-866171A01	REC35-866171A01	153	47-89984T4	REC47-89984T4	199-247-249	62092T	REC62092T	157
35-866340Q03	REC35-06003	154	47-8M0104229	REC47-862232A2	199	65533A1	REC65533A1	263
35-866594K01	RM35-866594Q01	153	47-F462065	REC47-F462065	199	69578A1/Q1/T1	REC11-69578Q1	276
35-866594Q01	RM35-866594Q01	153	48752T	REC48752T	247-249	70981A3	REC70981A3	223-225-229-233-235-237-243
35-879172143	REC35-879172143	155	50-12782	REC3854190	175	733-803850T	RM733-810852	221
35-879312041	REC35-879312041	156	50-47454	REC50-97499A2	176	733-810852	RM733-810852	221
35-881132T	REC35-8M0138697	154	50-56886	REC3854190	175	735-835001T	REC10006	221
35-883702Q	REC35-06004	154	50-65785A1	REC50-97499A2	176	735-850097	REC10006	221
35-884380T	REC35-8M0122423	153	50-69865A1	REC3854190	175	73873A1	REC73873A1	264
35-892665	REC35-892665	154	50-72550A2	REC50-97499A2	176	74639Q02	REC74639Q02	263-267-269
35-895207	REC895207	193	50-79604A3	REC50-97499A2	176	75832T	REC75832T	245-251
35-898272048	REC35-898272048	156	50-805991	REC3916854	176	75832T1	REC3850812	245-251
35-8M0020349	REC35-8M0122423	153	50-806963A2	REC50-806965A4	176	76214-4	REC762144/AL	261
35-8M0046752	REC35-8M0046752	153	50-806965A2	REC50-8M0090697	176	76214Q5	REC76214Q5/AL	261
35-8M0060041	REC35-8M0122423	153	50-806965A4	REC50-806965A4	176	76850A2	REC76850A2	272
35-8M0066483	REC35-8M0066483	156	50-806965A4	REC50-8M0090697	176	77442A1	REC21990	273
35-8M0067337	REC35-8M0067337	154	50-806965A4	REC50-99417A2	176	78403A1	REC78403A2	177
35-8M0116378	REC35-06007	154	50-808011A05	REC50-808011A05	176	78403A2	REC69729	177
35-8M0138697	REC35-8M0138697	154	50-80811A4	REC50-808011A05	176	78403A32	REC78403A2	177
35-8M0150917	REC882687	156	50-812429A2	REC50-8M0090697	176	78458A1	REC78458A1	268-270
35-8M6002131	REC35-8M6002131	155	50-863007A1	REC50-806965A4	176	802556T	REC938-8M0087884	216
35-8M6002390	REC35-8M6002390	155	50-863007A1	REC50-863007A1	175	803850T	RM733-810852	221
36-97335	REC3853341	217	50-864340A2	REC3885317	175	804483T	REC3854548	183
36223A1	REC36223A2	270	50-864340A2	REC50-99418A2	175	805025A2	REC3858261	160
36223A2	REC36223A2	270	50-88671A1	REC50-808011A05	176	805025A2	REC861155A6	160
39-17464	REC11001	221	50-8M0090697	REC50-8M0090697	176	805101T	REC805101T	259

OEM	REF		OEM	REF		OEM	REF	
805185A3	REC805185A3	185	821630Q1	REC821630Q1/AL	261	864297T01	REC864297T01	171
805185A37	REC805185A3	187	821631Q1	REC821631Q1/AL	261	864625T	REC864625T	204
805217A1	REC3850396	169	822777Q1	REC822777Q1/AL	262	864856A1	REC3850396	169
805218T	REC3850397	172	823426A1	REC823426A1	165	865182Q01	REC865182Q02AL	262
805222A1	REC805222A1	185-186	823427A1	REC823427A1	165	865329A02	REC865329A02	264-270
805223T	REC805223T	172	824317 1	REC13505	218	865496A01	REC865496A02	256
805224A1	REC3855194	170	827682T	REC827682T	159	865496A02	REC865496A02	253
805226A1	REC8M0125617	169	828151A1	REC882751A1	179	866169A01	REC866169T01	160
805227A1	REC805227A1	162	835001T	REC10006	221	866169T01	REC866169T01	160
805320A03	REC805320A03	171-265-269	835257K12	REC835257K12	276	866169Y01	REC866169T01	161
805447T	REC805884T	177	84-813715A1	REC15-103	183	866170A01	REC866170A01K	161
805536A2	REC805536A2	245-251-253	84-813720A10	REC15-801	182	866170A01	REC866170A01K	160
805544T	REC8M0077616	170	84-813720A11	REC15-601	182	866171A01	REC35-866171A01	161
805656A2	REC3858261	160	84-813720A13	REC15-405	182	86840A05	REC86840A05	268-270
805656A2	REC861155A6	160	84-813720A3	REC15-804	182	86840A3	REC86840A05	270
805656A5	REC3858261	160	84-813720A4	REC15-804	182	87-133982	REC87-133982	180
805656A5	REC861155A6	160	84-813720A5	REC15-401	182	87-18286A43	REC87-18286A43	180
805656A6	REC3858261	160	84-813720A5	REC15-402	182	87-19674A1	REC87-19674A1	180
805656A6	REC861155A6	160	84-813720A7	REC15-604	182	87-76416A1	REC3853839	179
805759A2/1	REC805759Q01	184	84-813720A8	REC15-801	182	87-805605A1	REC87-805605A1	171
805759A5	REC805759Q01	184	84-816608A1	REC15-815	182-187	87-808009A2	REC87-808009A2	264
805759Q01	REC805759Q01	184-187	84-816761Q13	REC15-405	186	87-808009A2	REC87-808009A2	264
805759T2	REC805759Q01	184	84-816761Q16	REC15-601	186-187	87-814281A5	REC87-814281A5	264
805759T2/1	REC805759Q01	184	84-816761Q17	REC15-804	186-187	87-815425T	REC8M0068784	171
805884T	REC805884T	177	84-816761Q7	REC15-604	182	87-858679T2	REC87-858679T2	180
805930A1	REC15533	220	84-816768A17	REC15-804	182	87-859032T02	REC87-859032T02	180
806105Q1	REC806105Q1/AL	261	84-817376T01	REC84-817376T01	186	87-864252	REC87-864252	172
806189Q1	REC806189Q1/AL	261	84-818781A4	REC15-804	182	87-864252A01	REC87-864252A01	172
806190Q1	REC806190Q1/AL	261	84-863656A1	REC15-813	183-187	87-892150Q02	REC87-892150Q02	187
806191T	REC806191T	274	84-863656A2	REC15-606	187	87-8M0052935	REC87-808009A2	264
806193A20	RM806193A48	194	84-866337T01	REC84-866337T01	190	87-91941A8	REC87-91941A8	180
806193A38	RM806193A48	194	84-892990T01	REC84-892990T01	190	879150A65	REC879150A65	262
806193A48	RM806193A48	194	84-8966539T01	REC84-8966539T01	190	879150A65	REC879150A65AL	262
806490T	REC806490T	172	84-896540T01	REC84-896540T01	190	879150A87	REC21622232	185-187
806612T	REC806612T	170	84-896542T05	REC84-896542T05	190	879194A01/A02	REC30-879194A01	267
806673T/1	REC806673T1	181	84-8M0055044	REC84-8M0055044	190	879312T67/76	REC3854138	179
807151A14	REC46-807151A14	200	842725A3	REC8M0073435	158	881070T	REC8M0125617	169
807166A1	REC807166A1	226-229-230-231-235-237-242	850484T	REC3854331	183	881879A6	REC881879T11	171
807166A3	REC807166A3	242	850484T2	REC3854331	183	881879T11	REC881879T11	171
807252Q3	REC807252Q3	193	852956A1	REC3858941	162	882751A04	REC882751A04	179
807252Q4	REC807252Q4	193	853678T	REC853678T	169	882751A1	REC3854138	179
807252Q5	REC807252Q5	193	859210T	REC881879T11	171	882751A2	REC3854138	179
807252T1	REC8M0089715	193	859604A1	REC881879T11	171	883297R1	REC938-803860T	216
807252T2	REC8M0091470	192	860256A4	REC8M0061381	191	883297R50	REC938-803860T	216
807252T3	REC807252Q3	193	860349A1	REC860349A1	162	883710A02	REC883710A02	188
807252T4	REC807252Q4	193	861006A1	REC8M0061381	191	884794A02	REC21622232	185
807252T6	REC807252Q3	193	861126A1	REC861126A1	162	884794A1	REC21622232	185
807652T	REC807652T	178	861155A2	REC861155A3	160	88751A02	REC40005334	185
807653T	REC807653T	178	861155A3	REC861155A3	160	888751A03	REC40005334	185-187
807729T	REC8M0153706	204	861155A5	REC3858261	160	888751A1	REC40005334	185
807757T	REC807757T	204	861155A6	REC861155A6	160	888756Q03	RECKITMMPALPHA2AL/M/ZN	251-253-255-262
807929A1	REC807929A1	255	861155A6	REC3858261	160	888756Q04	RECKITMMPALPHA1AL/M/ZN	247-249-262
807952A1	REC807952A1	162	861155A6	REC861155A6	160	888758Q02	RECKITMBRAVO1AL/M/ZN	256-257-262
807964A1	REC807964A1	185-186	861156A03	REC861156A03	161	888761Q03	RECKITMBRAVO23AL/M/ZN	258-262
808483T3	REC3854548	183	861156A1	REC861156A1	159	888761Q04	RECKITMBRAVO3AL/M/ZN	259-262
808504T1	REC65L-13915-00	154	861249A1	REC861249A1	169	889514A01	REC8M0052939	264
809463A1	REC3859054	179	861676A1	REC8M0073435	158	89-18080	REC3853869	179
81-64851	REC64851	184	861676T09	REC8M0073435	158	89-68258A4	REC852565	179
810845T	RM810845	220	861677T	REC861677T	157	89-853654A1	REC3853869	179
811635T3	REC3854260	183	862030T	REC862030T01	177	89-853654A1	REC852565	179
811637T	REC3854003	182	862030T01	REC862030T01	177	89-91975	REC89-96054T	179
811639T	REC3854001	169-182-186	862031T/1	REC862031T1	177	89-96054	REC89-96054T	179
812454A1	REC862048A1	157	862048A1	REC862048A1	157	89-96054T	REC89-96054T	179
812454A3	REC862048A1	157	862077A1	REC862077A1	157	89-96158/T	REC89-96158T	179
813715A1	REC15-103	183	862344A	REC862344A	158	89-99253	REC3853869	179
814281A7	REC8M0052939	264	862344A4	REC862344A4	158	892451T06	REC892451T06	190
815407A2	REC815407A2	183	862351T	REC862351T	196	892451T10	REC892451T10	190
815407Q02	REC815407A2	183-187	86246A1	REC86246T	158	892451T20	REC892451T20	190
815471T1	REC815471T1	271	86246T	REC86246T	158	892984A02	REC892984A02	188
816431A1	REC816431A1	266-270	86247A2	REC86247T	158	892984K32	REC892984K32	190
816597A1	REC816597A1	255	86247T	REC86247T	158	893353A03	REC893353A03	180
817119A1	REC3860769	177	862548A1	REC42419A1	178	893378A02	REC893378A02	190
817119A4	REC3860769	177	863077T	REC863077T	178	896377A01	REC896377A01	190
817119A4	REC78403A2	177	86307AR01	REC863077T	178	896542T01	REC896542T01	190
817275Q05	REC817275Q05	200	863444T1	RM863444T1	191	896542T03	REC896542T03	190
817377T	REC817377T	185	863631T1	RM863631T1	191	896542T05	REC84-896542T05	190
817378T	REC3854002	181	863786A1	REC22-863786A1	232	896542T08	REC896542T08	190
818383T	REC861677T	157	863802T2	REC863802T2	191	898253T22	REC898253T22	184-187
821509T01	REC882751A04	179	864148A01	RM21325765	168	898253T23	REC898253T23	184-187
821629Q1	REC821629Q1/AL	261	864244A2	REC864244A2	256	898253T24	REC1463-9382	181

OEM	REF		OEM	REF	
898253T27	REC3854002	181-186	8M6001253	REC3854549	184-186
8M0011213	REC8M0011213	188	8M6001254	REC3854261	184-186
8M0029482	REC300-8M0044991	181	8M6002428	REC8M6002428	162
8M0030550	REC8M0030550	188	8M6003194	REC8M6003194	170
8M0032176	REC876037	180	8M6005225	REC879194401	196
8M0039340	REC879150A65	262	8M6500024	REC8M6500024	204
8M0039340	REC879150A65AL	262	90576A4	REC13524A6	184
8M0052939	REC8M0052939	264	907964A1	REC807964A1	185
8M0054588	REC3861985	181	91-12037	REC91-12037	275
8M0054726	REC8M0054726	169	91-17256	REC91-17256	275
8M0056956	REC15000K	199	91-17273	RM91-17273	275
8M0057679	REC8M0133370	161	91-43579	REC91-43579	275
8M0057686	REC8M6002428	162	91-45497A1	REC91-45497A1	276
8M0057697	REC876037	180	91-78310	REC91-78310	275
8M0058164	REC8M0058164	158	91-805475A1	REC91-805475A1	275
8M0061381	REC8M0061381	191	91-818162	REC91-818162	276
8M0062084	REC3854311	184	91-888863	REC91-888863	186
8M0062406	REC86840A05	270	92497A3	REC78403A2	177
8M0062614	REC32-33220	205	938-4625	REC938-7499	216
8M0062770	REC8M0062770	160-161	938-7358	REC938-7499	216
8M0066646	REC8M0093480	192	938-7499	REC938-7499	216
8M0067268	REC57-8M0093495	204	938-802556	REC938-8M0087884	216
8M0067292	REC8M0093480	192	938-803860T	REC938-803860T	216
8M0068607	REC41802	230	938-883297R1	REC938-803860T	216
8M0068784	REC8M0068784	171	938-8M0087884	REC938-8M0087884	216
8M0073409	REC17-8M0073409	263	938-8M0115137	REC938-803860T	216
8M0073435	REC8M0073435	158	97-257	REC806490T	172
8M0077608	REC27-49955	220	97257A1	REC806490T	172
8M0077616	REC8M0077616	170	97258A1	REC97258A1	172
8M0079291	REC8M0079291	189	97399A2	REC862048A1	157
8M0080805	REC8M0080805	263-267-273-274	98-8M0121940	REC98-8M0121940	200
8M0084884	REC25-8M0084884	195	98230A1	REC98230A1	265-269
8M0087834	REC8M0087834	169	99370A2	REC99370A2	242
8M0087884	REC938-8M0087884	216	F1027	REC314502	276
8M0089715	REC8M0089715	193	F455342	REC326649	220
8M0090424	REC54-38863	271	F461342	REC304174	220
8M0091470	REC8M0091470	192	F462065	REC47-F462065	199
8M0092489	REC8M0092489	180	Fl1100255	REC13508	218
8M0093480	REC8M0093480	192	Fl1100305	REC13001	221
8M0093561	REC8M0093561	192	Fl1100382	REC13024	221
8M0094406	REC879194401	196	Fl1100573	REC13002	221
8M0095310	REC8M0095310	171-265-269	Fl1100609	REC10501	216
8M0095468	REC8M0142695	170-230	Fl1100651	REC12001	216
8M0095953	REC8M0095953	230	Fl1100810	REC13502	218
8M0098619	REC8M0098619	168	Fl1101076	REC59341A1	219
8M0100483	REC8M0100483	189	Fl1101190	REC938-7499	216
8M0100485	REC8M0100485	189	Fl1101207	REC12001	216
8M0101601	REC8M0101601	276	Fl1101263	REC59341A1	219
8M0101603	REC8M0101601	276	Fl1101295	REC809910	220
8M0111642	REC8M0111642	204	Fl5110026	RECBS40013	217
8M0113733	REC46-8M0113733	195	Fl6900041	REC12532	184
8M0113734	REC46-8M0113734	195	Fl6900100	REC12532	184
8M0117678	REC15-808	183	Fl6900152	REC97258A1	172
8M0122492	RM810845	220	Fl6900165	REC12532	184
8M0125617	REC8M0125617	169-224	Fl6900185	REC392-9766	183
8M0129714	REC8M0155633	196	Fl6900198	REC97258A1	172
8M0133370	REC8M0133370	161	GM10482803	REC3858984	182
8M0142542	REC8M0142542	173			
8M0142695	REC8M0142695	170			
8M0144930	REC8M0144930	180			
8M0146076	REC13507	218			
8M0148530	REC8M0148530	196			
8M0148668	REC8M0148668	173-224			
8M0150300	REC809910	220			
8M0153706	REC8M0153706	204			
8M0155633	REC8M0155633	196			
8M0188302	REC938-803860T	216			
8M0204674	REC94576	197			
8M0204733	REC54-38863	271			
8M0207773	REC3854138	179			
8M2000229	REC10-53728	230-232			
8M2000819	REC27-33395	232			
8M2003959	REC8M2003959	170-224-230-232			
8M2004414	REC8M2004414	230-232-241			
8M2015937	REC8M2015937	251-253			
8M2015938	REC8M2015938	251-253			
8M6000623	REC8M6000623	172			
8M6000634	REC8M6000634	171			
8M6000652	REC8M6002428	162			
8M6001222	REC898253013	184-187			

REF --> OEM

REF	OEM	
<b>P</b>		
PAF15-07010004	479452	226
PAGB/T93-10	41471	230
PAGB/T93-10	13-41471	224
<b>R</b>		
REC016940		150
REC0307239	25-33504	219-266
REC0554545	25-47632	219
REC0580256	802350	184
REC0581419	802357	184
REC0987883		175
REC10-28668	10-28636	263
REC10-28668	10-28668	245-253-251
REC10-32470	10-32470	247-249
REC10-37612	10-37612	237-238
REC10-43749	10-43749	226-229-231-235-237
REC10-53728	10-53728	223-224-226-229-231-235
REC10-53728	8M2000229	230
REC10-53728		232
REC10-668631	668631	230-232
REC10-668631	10-668631	223-224
REC10-79953Q04	10-79953Q04	152-245-251-253
REC10-806290	10-806290	274
REC10-816601	10-816601	251-253-259
REC10-861788	10-861788	175-176
REC10-86801	10-86801	265-269
REC10-97934	10-97934	270
REC10-97934A1	10-97934A1	264-270
REC10006	735-835001T	221
REC10006	735-850097	221
REC10006	835001T	221
REC10501	34510	216
REC10501	10-34510	216
REC10501	FI1100609	216
REC10615K	47-879312025	196-199
REC11-22339	11-22339	245-251-253-256
REC11-34933	11-134391	266
REC11-34933	11-34933	263-267
REC11-34933	11-859116	245-247-249-259-268-273-274
REC11-34933		266-268
REC11-52707Q1	11-52707Q1	247-249-254-255-257
REC11-6957801	11-69578/A1/Q1	276
REC11-6957801	69578A1/Q1/T1	276
REC11-859135	859135	204-251
REC11-859135	11-859135	253
REC11-862903	82671013	273
REC11-862903	11-134371	265-269
REC11-863332	11-863332	270
REC11001	17464	221
REC11001	39-17464	221
REC11004	17464	221
REC11004	8018611	221
REC11004	39-17464	221
REC11004	39-801861	221
REC11004	39-8018611	221
REC11979-0001	47-896332063	199
REC12-191833	12-19183-3	259
REC12-191833	12-191833	245-247-249-251-253-255-256-257-258
REC12-191833		151-255
REC12-20084	12-20084	198-222-223-224
REC12-32666	12-32666	245-266
REC12-32834	12-32834	270
REC12-35777	12-35777	270
REC12-44163	12-44163	273-274
REC12-44164	12-44164	274
REC12-45176	12-35935	251-253-266-268
REC12-45176	12-45176	259
REC12-45176		266-268

REF	OEM	
REC12-45810	12-45810	245-251-253
REC12-72498	12-72498	268
REC12-815472	12-815472	264
REC12-815952	12-815952	274
REC12-85058	12-85058	273
REC12001	34532	216
REC12001	35330	216
REC12001	58284	216
REC12001	99948	216
REC12001	FI1100651	216
REC12001	FI1101207	216
REC12120	46-96148A8	200-248-249
REC125017	25-23145	219
REC12532	FI6900041	184
REC12532	FI6900100	184
REC12532	FI6900165	184
REC12644A1	12644A1	243
REC12708	12708	256
REC127695-35150	35-19485	156
REC13-33734	13-33734	270
REC13-35048	13-35048	223-224-225-226-229-231-233-235-237-238-256
REC13-39107	13-39107	225
REC13-423511	13-42351-1	247-257
REC13-423511	13-423511	249-255
REC13-423511		255-257
REC13001	15961	221
REC13001	52221	221
REC13001	85701	221
REC13001	23-85701	221
REC13001	FI1100305	221
REC13002	52224	221
REC13002	85704	221
REC13002	1596110	221
REC13002	23-85704	221
REC13002	FI1100573	221
REC13010	11992001	221
REC13010	23-11992	221
REC13010	23-11992001	221
REC13011	811858001	221
REC13011	23-811858	221
REC13011	23-811858001	221
REC13012	818465	221
REC13012	23-818465	221
REC13013	818467	221
REC13013	23-818467	221
REC13018	69887	221
REC13018	85691	221
REC13018	23-85691	221
REC13019	85726001	221
REC13019	23-85726001	221
REC13019	39-827651T	221
REC13024	52225	221
REC13024	85705	221
REC13024	1596120	221
REC13024	23-85705	221
REC13024	FI1100382	221
REC13037	13037	179
REC13037	8733261	179
REC1347-816373A4	1347-6492A1	163
REC1347-816373A4	1347-7362A1	163
REC1347-816373A4	1347-804624R02	163
REC1347-816373A4	1347-816373A4	163
REC1347-816373A4	1347-8292A4	163
REC1347-816373A4	1347-9415T	163
REC1347-816373A4	1347-9662A4	163
REC1347-816373A4	3310-804624R1	163
REC1347-816373A4		164
REC13501	52367	218
REC13501	810850	218
REC13502	85803	218
REC13502	87284	218
REC13502	87824	218

REF	OEM	
REC13502	824317	218
REC13502	FI1100810	218
REC13504	97661	218
REC13505	8243171	218
REC13506	97661	218
REC13507	809992	218
REC13507	8M0146076	218
REC13508	35323	218
REC13508	FI1100255	218
REC13524A1	13524A1	184
REC13524A1	13524A5	184
REC13524A1	13524T1	184-187
REC13524A6	13524A4	184
REC13524A6	13524A6	184
REC13524A6	13524Q06	184-187
REC13524A6	19405A4	184
REC13524A6	90576A4	184
REC1396-4656	1396-4656	165-167
REC1396-5238	1396-5222	165
REC1396-5238	1396-5238	165
REC1397-6367A1	1397-6367A1	165
REC13980	22-806608A1	222-223-224-242
REC1463-9382	38547	181
REC1463-9382	32193A2	181
REC1463-9382	392-806529A1	181
REC1463-9382	898253T24	181
REC15-103	813715A1	183
REC15-103	84-813715A1	183
REC15-401	84-813720A5	182
REC15-402	84-813720A5	182
REC15-405	84-813720A13	182
REC15-405	84-816761Q13	186
REC15-405		185
REC15-601	84-813720A11	182
REC15-601	84-816761Q16	186-187
REC15-601		185
REC15-604	84-813720A7	182
REC15-604	84-816761Q7	182
REC15-604		185
REC15-606	84-863656A2	182-185-187
REC15-801	84-813720A10	182
REC15-801	84-813720A8	182
REC15-804	84-813720A3	182
REC15-804	84-813720A4	182
REC15-804	84-816761Q17	186-187
REC15-804	84-8167681A17	182
REC15-804	84-818781A4	182
REC15-804		182-185
REC15-808	881698	183
REC15-808	8M0117678	183
REC15-813	84-863656A1	183-187
REC15-815	84-816608A1	182-187
REC15-815		185
REC15000K	3349198	199
REC15000K	3916720	199
REC15000K	47-853126	199
REC15000K	8M0056956	199
REC15000K		196
REC15353	13840A1	220
REC15353	805930A1	220
REC16-49545	16-49545	222-225-229-233-235-237-238
REC16-59579	35937	276
REC16-59579	59579	276
REC16-59579	16-59579	266-268-276
REC16-59579	56-90415A24	276
REC16-70236	16-70236	222-223
REC16-806300	16-806300	224
REC16755Q1	16755Q1	151-152-268-269
REC16792A39	16792A39	264
REC17-8M0073409	17-8M0073409	267
REC17-8M0073409	8M0073409	263
REC17-8M0073409		267

REF	OEM	REF	OEM	REF	OEM
REC17000		REC21990	77442A1	REC26-32511	26-32511 219-245
REC17010		REC21990		REC26-32511A1	26-32511A1 245
REC17020		REC22-328022	22-328022	REC26-33144A2	26-33144A2 246-247-248-249
REC17030		REC22-328022		REC26-34217	26-34217 218
REC17040		REC22-36382	22-36382	REC26-36556	26-36556 257-258
REC17042		REC22-41622	22-41622	REC26-36557	26-36557 245
REC17046				REC26-38970	26-38970 247-249
REC17048				REC26-419533	26-41953 219
REC17100	207-208	REC22-67892A05		REC26-43035	26-43035 219
REC17102	208	REC22-73379	73379	REC26-43036	26-43036 219
REC17110	209	REC22-73379	10-74727	REC26-43993	26-43993 219-256
REC17116	209	REC22-73379	22-73379	REC26-455771	26-45577 1 219-247-249
REC17116	209	REC22-73379		REC26-455771	26-45577-1 255-259
REC17117	209	REC22-73379		REC26-455771	26-455771 257-258
REC17120		REC22-861150T02	22-861150A1	REC26-455771	26-455771 151-255
REC17124	211-212	REC22-861150T02	22-861150A2	REC26-54925	26-54925 263
REC17125	210-212	REC22-861150T02	22-861150T02	REC26-55682	25-55682 219-263
REC17140	210-212	REC22-861150T02		REC26-56397	26-56397 219
REC17140	214-215	REC22-862225	22-862225	REC26-66302	26-66302 219-251-253-255
REC17146	214-215	REC22-863786A1	863786	REC26-69188	26-69188 219
REC17200	207-208	REC22-863786A1	22-863786A1	REC26-69189	26-69189 219
REC17207	215	REC22-863786A1	22-863786A1	REC26-70081	26-70081 219
REC17210	208	REC22-863786A1	863786A1	REC26-72785	26-72785 198-219
REC17211	209	REC23-29804T	23-29804T	REC26-75624	26-75413 218
REC17212	209	REC23-30617A2	23-30617A2	REC26-75624	26-75624 216-218
REC17214	211	REC23-806036A1	23-806036A1	REC26-75988	26-75988 218
REC17220	210	REC23-806922	23-806922	REC26-76868	26-14077 219-255
REC17224	210	REC23-807073	23-807073	REC26-76868	26-76868 219-247-249-257-258
REC17230	211	REC23-815921A21	23-815921A21	REC26-76868	255-257-258
REC17231	212	REC23-8159501	23-8159501	REC26-76868A04	26-76868A04 257-258-259
REC17232	212	REC23-816583	23-816583	REC321466	26-79831 219
REC17240	213	REC23-847637	23-847637	REC26-805344	26-805344 257-258-259
REC17241	213	REC23-89574	23-89574	REC26-807006	26-807006 219-256
REC17242	213	REC23-99291	23-99291T	REC26-811554	26-811554 217
REC17243	214	REC23-99299	23-99299	REC26-8164641	26-816464-1 255
REC17246	213	REC25-21836	25-21836	REC26-8164641	26-8164641 219-247-249
REC17248	215	REC25-25439	25-25439	REC26-816575A2	26-816575A2 255
REC17310	209	REC25-30224	25-30224	REC26-816575A3	26-816575A3 254-255
REC17320	211-212	REC25-30224Q	25-30224Q	REC26-821092	26-821092 219
REC17340	214-215	REC25-30613	25-30613	REC26-8219471	26-8219471 217
REC17341	214-215	REC25-31534	25-31534	REC26-823894	26-823894 219-245-251-253
REC17342	214	REC25-32546	25-32546	REC26-861694	26-805080 219
REC17900	207-208	REC25-33145	25-33145	REC26-861694	26-861694 259
REC17903	207-208	REC25-33465	25-33465	REC26-864319	26-864319 253-255
REC17920	210	REC25-33465	25-54029	REC26-88397	26-88397 251-253
REC17921	210	REC25-33465	25-822370	REC26-88397A1	26-88397A1 251-253
REC17930	211-213	REC25-34821	25-34821	REC26-88416	26-88416 263-267
REC17931	211-212	REC25-35027	25-35027	REC26-89238	26-89238 219-247-249
REC17935	214-215	REC25-35029	35029	REC26-892683	892683 161
REC17937	214-215	REC25-35029	802231	REC26-892683	26-892683 161
REC17937-0001	47-879194186	REC25-35029	882613	REC26-8M0033407	26-8M0033407 259
REC17950		REC25-35029	25-35029	REC26-8M0150312	26-804507 218
REC17970	207-208	REC25-36318	25-36318	REC26-8M0150312	26-8M0150312 218
REC17971	210	REC25-457101	25-457101	REC26-8M2005029	26-416071 263-267
REC17980	211-212	REC25-48171	25-48171	REC26-90562	26-90562 198-219
REC17981	211-212	REC25-55801	25-55801	REC26-965031	26-965031 219-245
REC17982	211-212	REC25-67202	25-67202	REC27-14241	14241 217
REC17985	49107	REC25-70937	25-70937	REC27-14241	881715 217
REC17985	52550	REC25-8071341	25-8071341	REC27-14241	27-14241 217
REC17985	27-52550	REC27-8M0094247	811461	REC27-14241	27-881715 217
REC18-32665	18-32665	REC25-87400A2	25-87400A2	REC27-14241	27-883964T 217
REC18-8114	166	REC25-8M0084884	25-26802	REC27-142471	27-14250 217
REC18-8115	166	REC25-8M0084884	25-8071341	REC27-14250	27-14250 217
REC18654A1	32734	REC25-8M0084884	25-8M0039163	REC27-18272	27-18272 225-241
REC18654A1	18654A1	REC25-8M0084884	8M0084884	REC27-33179Q02	27-33179Q02 192
REC18654A1	32734A3	REC25-90011	25-90011	REC27-33395	27-33395 231-233-235-238-243
REC18654A1		REC25-94288	94288	REC27-33395	8M2000819 232
REC18920A1	18920A1	REC25-94288	896523	REC27-33395	27-33956 211
REC19-14842	19-14842	REC25-94288	25-94288	REC27-33918	27-8M2021920 192
REC19-47579		REC25-97387	97387	REC27-33956	27-33956 197
REC19-815951	19-815951	REC25-97387	25-97387	REC27-34213	27-34213 157-158
REC19-864689	19-864689	REC25W40U3		REC27-344861	27-34486-3 187
REC19674A07	19674A07	REC26-12224	26-12224	REC27-34897	27-34897 197
REC21622232	879150A87	REC26-12709	26-12709	REC27-34898	27-34898 158
REC21622232	884794A02	REC26-14240	26-14240	REC27-39915	27-39915 239-241
REC21622232	884794A1	REC26-14756	26-14756	REC27-41812Q	27-41812 192
REC21811		REC26-16709A2	26-16709A2	REC27-41812Q	27-41812Q 192
REC21920		REC26-16977	26-16977	REC27-42457	27-42457 158
REC21990	45523				
REC21990	77443				
REC21990	45706A4				

REF	OEM	
REC27-426311	27-42631-1	249
REC27-430331	27-430331	255
REC27-46820	27-46820	214-237-238-243
REC27-47510Q	27-47510Q	192
REC27-475901	27-47590-1	192
REC27-48042	27-48042	238-241
REC27-480431	27-40431	238
REC27-480431	27-480431	222-225-233-238-242
REC27-48399	27-48399	164-167
REC27-48818Q01	27-48818Q01	192
REC27-49110	27-49110	197
REC27-49953	27-49953	217
REC27-49955	49953	220
REC27-49955	49955	220
REC27-49955	27-49955	220
REC27-49955	27-8M0077608	220
REC27-49955	8M0077608	220
REC27-524572	27-524572	164-166-167-168
REC27-52546	27-52546	207-239-243
REC27-53045Q01	53051	192
REC27-53045Q01	27-53045Q01	192
REC27-53354	27-53354	208-222-243
REC27-5401401		152
REC27-558101	27-55810 1	245
REC27-60715	27-60715	164
REC27-64692	27-64692	164-166-222-223
REC27-64818Q4	26-64818Q4	245-266-269
REC27-64818Q4	27-64718A1	245
REC27-64818Q4		245-266
REC27-65577	27-65577	164
REC27-68714A6	27-68714	206-217
REC27-68715	27-68715	216-225-243
REC27-72805	27-72805	158
REC27-73666	27-73666	216
REC27-74830	27-74830	192
REC27-8052151	27-8052151	198
REC27-805760	27-805760	187
REC27-807218	27-807218	222-223-225-242
REC27-807473A1		211-212
REC27-8079821	8079821	164
REC27-8079821	27-70143	164
REC27-8079821	27-701431	164
REC27-8079821	27-807982	164
REC27-8079821	27-8079821	164-223-224
REC27-8079821		164-165-166-167
REC27-8146801	27-8146801	192
REC27-815528	27-815528	208-224-243
REC27-8172771	27-8172771	255
REC27-850456	27-85046	217
REC27-856081	27-856081	247-249
REC27-856704	27-856704	247
REC27-856705	27-856705	225-241
REC27-856705	27-97542	241
REC27-858524	27-858524	247-249
REC27-863724Q	27-41813	241
REC27-863724Q	27-860233	241
REC27-863724Q	27-863724	241
REC27-863724Q	27-863724Q	229-235-237-241
REC27-8637251	860231	241
REC27-8637251	863725	241
REC27-8637251	27-8637251	229-235-237-241
REC27-863726	27-818832	241
REC27-863726	27-860232	241
REC27-863726	27-863726	229-235-237-241
REC27-863726	27-871051	241
REC27-864547A02	27-864547A02	242
REC27-864850A02	27-864850A02	242
REC27-89656-1	27-89656-1	192
REC27-89656-1	27-896561	225
REC27-8M0094247	24-8M0094247	168
REC27-8M0094247	27-801333454	168
REC27-8M0094247	27-854129	168
REC27-8M0094247	27-898101475	168
REC27-8M0094247		168
REC27-94914	27-94914	198

REF	OEM	
REC27-94996Q2	27-94996Q2	151-152-251-253-266-269
REC27-96429	27-96429	207-208-223-243
REC27-988231	27-988231	263-267
REC27-995061	27-995061	263
REC27-99757	99757	230
REC27-99757	27-99757	226-227-229-243
REC27-99757		209
REC27-99777Q02	27-997771	241
REC27-99777Q02	27-997772	241
REC27-99777Q02	27-99777Q02	222-223-224-225-233-238-241
REC270	27-864547A02	226-231-241
REC270	27-864549A02	226-231-241
REC270	27-864550A02	241-226-231
REC270		226-231
REC28-161551	28-161551	197
REC28-8M0032833	28-8M0032833	255
REC294005		186
REC30-72961	30-72961	198
REC30-879194A01	30-879194A01	263-267
REC30-879194A01	879194A01/A02	267
REC30-879194A01		152-263-267
REC30-88957T	30-88957T	247-249
REC30-88957T	30-88957T1	255
REC30-88957T		255
REC300-00879	392-7803A4	181
REC300-00879	392-805570A2	181-187
REC300-8M0044991	300-8M0044991	181
REC300-8M0044991	8M0029482	181
REC301967	36318	220
REC301967	25-36318	220
REC302035	25-48452	219
REC302537	33466	220
REC302537	25-33466	220
REC302588	25-26722	219
REC303347	25-26802	219
REC304174	32509	220
REC304174	806609	220
REC304174	25-32509	220
REC304174	25-45253	220
REC304174	F461342	220
REC305123	33756	220
REC305123	25-33756	220
REC307450	802018	220
REC308627	25-20826	219-257-258-259
REC309955	309955	276
REC31-32575T1	31-32575T1	245-253-251
REC31-35988A12	31-35988A12	245-251
REC31-61100A1	31-61100A1	245-251
REC310414	25-47254	219
REC310584	20365	220
REC310584	35276	220
REC310584	25-35276	220
REC313175	67202	220
REC313175	25-67202	220
REC313754	802251	220
REC314491	802257	220
REC314502	89961	276
REC314502	802028	276
REC314502	18-82132M	276
REC314502	18-89961	276
REC314502	F1027	276
REC314728	802258	220
REC315810	802030	276
REC315810	859892	276
REC315810	859893	276
REC3164004	3164004	260-261
REC3164004AL	3164004	152-247-249-260-261
REC318717	802037	220
REC319085	802039	220
REC32-14358001	14358001	230
REC32-14358001	32-14358	243
REC32-14358001	32-14358001	226-227-229-231-235-237-243
REC32-14358001	32-14358T	243
REC32-16012	16012	205
REC32-16012	32-16012	205

REF	OEM	
REC32-32461	32-32461	205-263-266
REC32-32461	32-32461A1	205
REC32-32461		152
REC32-33189	32-33189	205-206
REC32-33220	3322070	205
REC32-33220	32-33220	205
REC32-33220	32-3322070	205
REC32-33220	32-55483	205
REC32-33220	32-8M0062614	205
REC32-33220	8M0062614	205
REC32-4172533	32-4172533	205-263-266
REC32-4172533	32-8M0062309	205
REC32-4172533		152
REC32-43437	32-43437	152-205-267
REC32-44348001	44348001	230
REC32-44348001	32-44348	243
REC32-44348001	32-44348001	223-224-226-227-229-231-235-237-243
REC32-44348001	32-44348T	243
REC32-54236	32-54236	245
REC32-808033	808033	205
REC32-808033	32-808033	205
REC32-860220	32-860220	251-253
REC32-86036	32-86036	272-273
REC32-86036	32-86036Q	272
REC32-861127	32-861127	272-273-274
REC32-861127	32-95858	272
REC32-861128	32-861128	272-273-274
REC32-861128	32-95859	272
REC32-864588	32-864588	272-273-274
REC32-864588	32-99903	272
REC32-864589	32-864589	272-273-274
REC32-864589	32-99902	272
REC32-864959	32-864959	272-274
REC32-864959	32-99903-1	272
REC32-864960	32-864960	272-273-274
REC32-864960	32-99902-1	272
REC32-871171	32-87117	205
REC32-871171	32-87117 1	205
REC32-871171		206
REC32-88795	32-88795	205
REC32-897181	89718	205
REC32-897181	897181	205
REC32-897181	32-897181	205
REC32-8M0071007		206
REC32-99904	32-99904	272
REC32-99904	32-99904Q	274-273
REC32077	25-896332077	194
REC320785	802045	276
REC32126	25-89633	195
REC32126	25-896332126	195
REC32175		226-227-229
REC326649	27018	220
REC326649	30224	220
REC326649	45711	220
REC326649	846361	220
REC326649	25-30224	220
REC326649	25-39695	220
REC326649	25-45711	220
REC326649	25-8M0204651	220
REC326649	30224Q	220
REC326649	F455342	220
REC326849	39695	220
REC326849	846361	220
REC326849	25-39695	220
REC3302-804689	3302-804689	164-165-166-167
REC3302-80484002	3302-80484002	164-165-166-167
REC3302-804845	3302-804845	166
REC3302-804845	3302-9437	166
REC3302-804845		164-167
REC3302-9031	1397-5837	162
REC3302-9031	3302-9031	162
REC3310-860070A2	1389-9562A1	163
REC3310-860070A2	3310-806077A2	163
REC3310-860070A2	3310-806078A2	163
REC3310-860070A2	3310-815396A2	163
REC3310-860070A2	3310-860070A2	163
REC3310-860070A2	3310-9350A2	163
REC3310-860070A2	3310-9562A1	163

REF	OEM		REF	OEM		REF	OEM	
REC3310-860070A2		164	REC3852865	25-805331	219-259	REC3861985	392-8M0054588	187
REC3310-864941A01	3310-864941A01	163-164	REC3852866	25-31986	219	REC3861985	8M0054588	181
REC3310-864942A01	3310-861448A1	163	REC3852928	26855	220	REC3861985		182
REC3310-864942A01	3310-864942A01	163	REC3852928	25-26855	220	REC3863130	898141	170-187
REC3310-864942A01		164-165	REC3853341	36-97335	213-217	REC387247	31-30956T	247-249-255
REC3310-864943A01	3310-861245A1	163	REC3853839	87-76416A1	179	REC387817	31-42647A1	249-255
REC3310-864943A01	3310-864943A01	163	REC3853869	89-18080	179	REC3885317	50-864340A2	175
REC3310-864943A01		165	REC3853869	89-853654A1	179	REC3916854	50-805991	176
REC331188	25-65936	219	REC3853869	89-99253	179	REC392-9766	392-9766	183
REC331880	17-35973	249	REC3853869		175-176	REC392-9766	392-9766Q1	183
REC33765		237-238	REC3854001	811639	169	REC392-9766	392-9766T	183
REC339543	20195	220	REC3854001	811639T	169-182-186	REC392-9766	F16900185	183
REC3412772	34127	261	REC3854002	817378	181	REC393-9459Q1	393-3230	183
REC3412772AL	34127	261	REC3854002	817378T	181	REC393-9459Q1	393-4988T	183
REC34762A1	34762A1	262	REC3854002	898253T27	181-186	REC393-9459Q1	393-4988T2	183
REC34762A1AL	34762A1	262	REC3854003	802464	182	REC393-9459Q1	393-9459Q1	183
REC35-06003	35-866340Q03	148-149-150-154	REC3854003	804412	182	REC40005334	88751A02	185
REC35-06004	35-883702Q	148-149-154	REC3854003	811637	182	REC40005334	888751A03	185-187
REC35-06007	60565	154	REC3854003	850487	182	REC40005334	888751A1	185
REC35-06007	35-802886Q	154	REC3854003	81637002	182	REC41674T	41674T	267-268
REC35-06007	35-8M0116378	154	REC3854003	811637001	182-186			226-229-230-231-235-237-263-267
REC35-19487	35-19487	156	REC3854003	811637T	182	REC41802	41802	
REC35-49088A2	35-49088A2	153	REC3854138	821382	179	REC41802	8M0068607	230
REC35-49088A2	35-49088Q2	153	REC3854138	828151/A1	179	REC42121Q02	42121Q02	261
REC35-49088A2		158	REC3854138	879312T67/76	179	REC42121Q02AL	42121Q02	261
REC35-802893Q		149-150	REC3854138	88275/A1/A2	179	REC42419A1	42419A1	178
REC35-802893Q01		148-149	REC3854138	8M0207773	170	REC42419A1	862548A1	178
REC35-805312	35-805312	156	REC3854190	50-12782	175	REC42724A3	42724A3	245
REC35-807256	35-807256T	155	REC3854190	50-56886	175	REC43-75325A3	43-75325A3	245-251
REC35-866171A01	35-866171A01	153	REC3854190	50-69865A1	175	REC43713	43713	263-267
REC35-866171A01	866171A01	161	REC3854260	3854260	186	REC821631Q1	43994	262
REC35-866171A01		149-150	REC3854260	811635T3	183	REC44-850308	44-850308	255
REC35-879172104		151	REC3854261	811636	184	REC45518T1	45518T1	266-271
REC35-879172143	35-879172143	151-155	REC3854261	8116361	184	REC46-44292Q03	46-44292Q03	200-249
REC35-879312041	35-879312041	151-156	REC3854261	898253011	184	REC46-807151A14	46-807151A14	198
REC35-892665	892665	161	REC3854261	8M6001254	184-186	REC46-807151A14	807151A14	200
REC35-892665	35-892665	154	REC3854261		183	REC46-807151A9	46-807151A9	196
REC35-892665		149-150	REC3854311	804424	184	REC46-862914T10	46-862914T10	196
REC35-898272048	35-898272048	151-156	REC3854311	850485	184-186	REC46-8M0113733	884727	195
REC35-8M0046752	35-11004A1	153	REC3854311	850485T	184	REC46-8M0113733	8M0113733	195
REC35-8M0046752	35-803897Q1	153	REC3854311	898253012	184	REC46-8M0113733	8M0113733	197
REC35-8M0046752	35-8M0046752	153	REC3854311	8M0062084	184	REC46-8M0113734	8503991	195
REC35-8M0046752		157-158	REC3854311		183	REC46-8M0113734	8M0113734	195
REC35-8M0066483	35-8M0066483	151-156	REC3854331	805484	186	REC46-8M0113734		197-204
REC35-8M0067337	35-8M0067337	151-155	REC3854331	3854331	183	REC46-96148A8	46-60367A1	201
REC35-8M0122423	35-884380T	153	REC3854331	850484T	183	REC46-96148A8	46-96148A5	201
REC35-8M0122423	35-8M0020349	153	REC3854331	850484T2	183	REC46-96148A8	46-96148A8	201
REC35-8M0122423	35-8M0060041	153	REC3854548	804418	183	REC46-96148T1	46-96148T1	247-249
REC35-8M0138697	35-881132T	154	REC3854548	808483	183			222-223-224-225-225-229-233-235-237
REC35-8M0138697	35-8M0138697	154	REC3854548	3854548	186	REC46335	46335	238
REC35-8M6002131	35-8M6002131	151-155	REC3854548	804483T	183	REC46399	46399	261
REC35-8M6002390	35-8M6002390	155	REC3854548	808483T3	183	REC46399AL	46399	261
REC3517857	35-803470	156	REC3854549	808484	184	REC47-43026Q02	47-43026Q02	152-199-255
REC3517857	35-80470Q	156	REC3854549	8084841	184	REC47-43026Q06	47-43026Q06	151-199
REC3593573	47-816814T	199	REC3854549	898253010	184	REC47-59362Q01	47-59362Q01	198-199
REC36223A2	36223	270	REC3854549	8M6001253	184-186	REC47-59362Q01		148-149-150-196
REC36223A2	36223A1	270	REC3855194	805224A1	170-173-174	REC47-59362T6	47-59362T6	197
REC36223A2	36223A2	270	REC3858261	805025A2	160	REC47-59362T6	59362T6	197
REC3841697	47-801332602	199	REC3858261	805656A2	160	REC47-809866T	47-809866T	199
REC3843100	879172105	172	REC3858261	805656A5	160	REC47-809866T	47-831311350	199
REC3843751	803149	170-173-174	REC3858261	805656A6	160	REC47-862232A2	47-862232A2	199
REC3850396	805217A1	169	REC3858261	861155A5	160	REC47-862232A2	47-8M0104229	199
REC3850396	864856A1	169	REC3858261	861155A6	160	REC47-862232A2		148-149-150-196
REC3850396		173-174	REC3858462	57-45856	205	REC47-89984Q5	47-89984Q5	152-246-248-151-200-247-249
REC3850397	805218	172	REC3858462	57-49213A1	205	REC47-89984T4	47-89984T4	152-199-247-249
REC3850397	805218T	172	REC3858462	57-93658Q	205	REC47-F462065	47-F462065	199
REC3850397		173	REC3858462		149-201-202	REC47-F462065	F462065	199
REC3850559	35-16595Q	154-156	REC3858941	852956A1	162-173	REC47820A1	47820	261
REC3850559	35-16595T1	156	REC3858984	GM10482803	182	REC47820A1AL	47820	261
REC3850559	35-52731	156	REC3859054	809463A1	175-176-179	REC48752T	48752T	247-249
REC3850812	75832	256	REC3860769	392-889925	181	REC48952	48952	172
REC3850812	75832T1	245-251	REC3860769	12449	177	REC50-806965A4	50-806963A2	176
REC3850812		256	REC3860769	19685	177	REC50-806965A4	50-806965A4	176
REC3852045	25-62704	219	REC3860769	817119	177	REC50-806965A4	50-863007A1	176
REC3852106	57-32850	205	REC3860769	817119A1	177	REC50-808011A05	50-808011A05	176
REC3852106	57-69143Q	205	REC3861267	392-881732	181			
REC3852106		148-201-202-203	REC3861985	392-863704T	181			
REC3852455	27-73866	210-213-238-243						
REC3852476	878990	240						

REF	OEM		REF	OEM		REF	OEM	
REC50-808011A05	50-80811A4	176	REC59341A1	97335	219	REC806190Q1	806190Q1	260-261
REC50-808011A05	50-88671A1	176	REC59341A1	26-97335	219	REC806190Q1AL	806190Q1	260-261
REC50-863007A1	50-863007A1	175	REC59341A1	59341A1	219	REC806191T	806191T	274
REC50-8M0090697	50-806965A2	176	REC59341A1	F11101076	219	REC806490T	806490T	36525
REC50-8M0090697	50-806965A4	176	REC59341A1	F11101263	219	REC806490T	806490	172
REC50-8M0090697	50-812429A2	176	REC60930	60930	224-242	REC806490T	811091	172
REC50-8M0090697	50-8M0090697	176	REC60932A4	60932A1	270	REC806490T	806490T	172
REC50-8M0095471	50-8M0095471	175	REC60932A4	60932A4	266-270	REC806490T	97-257	172
REC50-97499A2	50-47454	176	REC60932A4		151-152	REC806490T	97257A1	172
REC50-97499A2	50-65785A1	176	REC62092T	54552	157	REC806612T	806612T	170-173-174
REC50-97499A2	50-72550A2	176	REC62092T	62092	157	REC806673T1	806673T	181
REC50-97499A2	50-79604A3	176	REC62092T	62092T	157	REC806673T1	806673T1	181
REC50-99417A2	50-806965A4	176	REC62092T		159	REC807166A1	807166A1	226-229-230-231-235-237-242
REC50-99417A2	50-99417A2	176	REC64851	58034	184	REC807166A3	14348A1	242
REC50-99418A2	50-864340A2	175	REC64851	81-64851	184	REC807166A3	807166A3	242
REC50-99418A2	50-99418A2	175	REC65533A1	65533A1	263	REC807252Q3	807252Q3	193
REC500442		186	REC65L-13915-00	808504	154	REC807252Q3	807252Q3	193
REC500MA	35-850481	155	REC65L-13915-00	8085041	154	REC807252Q3	807252T6	193
REC500MA	35-850481A1	155	REC65L-13915-00	808504T1	154	REC807252Q4	807252Q4	193
REC500MACON		157	REC65L-13915-00		150	REC807252Q4	807252T4	193
REC53-29641	53-29641	249-255	REC69729	56045	177	REC807252Q5	807252T4	193
REC53-815949	53-815949	151-274	REC69729	59755	177	REC807252Q5	807252Q5	193
REC53400		227-229-235-237	REC69729	69729	177	REC807652T	807652	178
REC54-38863	38863	271	REC69729	78403A2	177	REC807652T	807652T	178
REC54-38863	866507	271	REC70817B	26-8M0050563	218	REC807653T	807653	178
REC54-38863	54-38863	271	REC70817B	26-97664	218	REC807653T	807653T	178
REC54-38863	54-866507	271	REC70817B	26-976641	218	REC807757T	807757T	204
REC54-38863	54-8M0090424	271	REC70981A3	70981A3	223-225-229-233-235-237-243	REC807929A1	807929A1	255
REC54-38863	54-8M0204733	271	REC73873A1	73873A1	264	REC807952A1	807952A1	162
REC54-38863	8M0090424	271	REC74639Q02	74639Q02	152-263-267-269	REC807952A1		173-174
REC54-38863	8M0204733	271	REC75832T	75832T	245-251	REC807964A1	807964A1	185-186
REC54-815504320		151	REC76214T1	76214	261	REC807964A1	907964A1	185
REC54-86049	54-86049	266-268-270	REC76214T1AL	76214	261	REC809064	809064	165-167
REC553126	31305	220	REC76214T1AL	76214	261	REC809065	809065	165
REC553126	25-31305	220	REC762144	76214-4	261	REC809065	823728	165
REC55989Q9	55989Q9	152-262-263	REC762144AL	76214-4	261	REC809065	835076	165
REC55989Q9AL	55989Q9	152-262	REC76214Q5	76214Q5	260-261	REC809065		164
REC55989Q9M	55989Q9	262	REC76214Q5AL	76214Q5	152-260-261	REC809910	14259	220
REC57-13457Q	57-13457Q	149-201-202-203-205	REC76850A2	76850A2	272	REC809910	809910	220
REC57-34359	57-34359	205	REC77123	77123	265	REC809910	8M0150300	220
REC57-34359	57-37619Q	205	REC78403A2	78402	177	REC809910	F11101295	220
REC57-34359	57-37619T	205	REC78403A2	78403A1	177	REC80W90U6		152
REC57-34359		149-201-202	REC78403A2	78403A2	177	REC811534	811534	165-166-167-168
REC57-48122Q	57-48122Q	202-203-205	REC78403A2	817119A4	177	REC815407A2	13753A2	183
REC57-49043A1	57-49043A1	205	REC78403A2	92497A3	177	REC815407A2	815407A2	183
REC57-49043A1	57-64032Q1	205	REC78458A1	78458	270	REC815407A2	815407Q02	183-187
REC57-49043A1		148-201-202	REC78458A1	78458A1	268-270	REC815471T1	815471T1	152-271
REC57-65607Q	57-65607T	148-201-205	REC78458A1		152	REC816431A1	816431A1	151-152-266-270
REC57-78200Q1	57-78200Q1	202-203-205	REC802555	802555	218	REC816597A1	816597A1	255
REC57-807755Q05	57-807755Q05	203-204	REC803148	803148	169-173-174	REC816607	816607	266
REC57-816295Q	57-816295Q	205	REC805100	805100	259	REC817275Q05	817275Q05	152-200
REC57-861757Q	57-861757Q	203-204	REC805101T	805101T	259	REC8172761	8172761	255
REC57-861758Q	57-861758Q	203-204	REC805185A3	805185A3	185	REC817377	817377	185-186
REC57-865615Q01	57-865615Q01	203-204	REC805185A3	805185A37	187	REC817377	817377T	185
REC57-865615Q03	57-865615Q03	148-149-203-204	REC805222A1	805222A1	185-186	REC821629Q1	821629Q1	160-261
REC57-865615Q04	57-865615Q04	148-149-203-204	REC805223T	805223	172	REC821629Q1AL	821629Q1	260-261
REC57-865615Q06	57-865615Q06	203-204	REC805223T	805223T	172	REC821630Q1	821630Q1	260-261
REC57-865615Q08	57-865615Q08	148-149-203-204	REC805223T		173-174	REC821630Q1AL	821630Q1	260-261
		148	REC8M0125617		173-174	REC821631Q1	821631Q1	260-261
			REC805227A1	805227A1	162-174	REC821631Q1AL	821631Q1	152-260-261
			REC805320A03	805320A03	152-171-265-269	REC822777Q1	822777Q1	262
REC57-879172120	57-879172120	151-204	REC805536A2	805536A2	245-251-253	REC822777Q1AL	822777Q1	262
REC57-879194425	57-879194425	204	REC805759Q01	43557	184	REC823426A1	823426A1	164-165-166-167-168
REC57-879194425	57-898101624	204	REC805759Q01	16457A4	184	REC823427A1	1397-2067	165
REC57-879194425		151	REC805759Q01	43557A1	184	REC823427A1	1397-2634	165
REC57-898101579	57-898101579	151-204	REC805759Q01	805759A2/1	184	REC823427A1	1397-3459	165
REC57-898101580		201	REC805759Q01	805759A5	184	REC823427A1	1397-7542/7	165
REC57-8M0088876	57-8M0088876	203-204	REC805759Q01	805759Q01	184-187	REC823427A1	1397-8872/3	165
REC57-8M0093495	57-8M0093495	204	REC805759Q01	805759T2	184	REC823427A1	823427A1	165
REC57-8M0093495	8M0067268	204	REC805759Q01	805759T2/1	184	REC823427A1		164-166
REC57-8M0093495		151	REC805884T	805884	177	REC824326002		209
REC57-8M0097728	57-8M0074767	204	REC805884T	805447T	177	REC827682T	827682	159
REC57-8M0097728	57-8M0097728	204	REC805884T	805884T	177	REC827682T	827682T	159
REC57-8M0097728		203	REC806105Q1	806105Q1	260-261	REC829207	57-48120Q1	148-149-201-202-205
REC59078Q3	59078Q3	148-192	REC806105Q1AL	806105Q1	152-260-261	REC835257K12	835257K12	276
REC59341A1	11973	219	REC806188Q01	806188	261	REC84-817376T01	84-817376T01	186
REC59341A1	42750	219	REC806188Q01AL	806188	261	REC84-819514T26		178
REC59341A1	54799	219	REC806189Q1	806189Q1	260-261	REC84-866337T01	84-866337T01	190
REC59341A1	59341	219	REC806189Q1AL	806189Q1	152-260-261			
REC59341A1	79223	219						

REF	OEM		REF	OEM		REF	OEM	
REC84-892990T01	84-892990T01	190	REC864625T	864625T	204	REC895207	879172151	194
REC84-896539T01	84-896539T01	190	REC865182Q01	865182	261	REC895207	35-895207	193
REC84-896540T01	84-896540T01	190	REC865182Q02AL	865182	261	REC895207		151
REC84-896542T05	84-896542T05	190	REC865182Q02AL	865182Q01	262	REC896332057	896332057	204
REC84-896542T05	896542T05	190	REC865193	865193	204	REC896377A01	896377A01	190
REC84-8M0055044	84-8M0055044	190	REC865329A02	865329A02	264-270	REC896542T01	896542T01	190
REC852565	89-68258A4	179	REC865436A03		152-271	REC896542T03	896542T03	190
REC852565	89-853654A1	179	REC865496A02	865496A01	256	REC896542T08	896542T08	190
REC853678T	853678	169	REC865496A02	865496A02	253	REC898253013	884790	184
REC853678T	853678T	169	REC865496A02		256	REC898253013	898253013	184
REC853678T		173-174	REC866169T01	866169A01	160	REC898253013	8M6001222	184-187
REC854445	854445	169-174	REC866169T01	866169T01	160	REC898253013		184
REC860349A1	860349A1	162-174	REC866169T01	866169Y01	161	REC898253T22	884792	184
REC861126A1	861126A1	162-173-174	REC866170A01K	866170A01	161	REC898253T22	898253T22	184-187
REC861155A3	861155A2	160	REC866170A01K	866170A01	160	REC898253T23	888731	184
REC861155A3	861155A3	160	REC86840A05	86840A05	268-270	REC898253T23	898253T23	184-187
REC861155A6	805025A2	160	REC86840A05	86840A3	270	REC8M0011213	8M0011213	188
REC861155A6	805656A2	160	REC86840A05	8M0062406	270	REC8M0030550	8M0030550	188
REC861155A6	805656A5	160	REC86840A05		151-152	REC8M0052939	814281A7	264
REC861155A6	805656A6	160	REC87-133982	87-133982	180	REC8M0052939	889514A01	264
REC861155A6	861155A5	160	REC87-18286A43	87-18286A43	180	REC8M0052939	8M0052939	264
REC861155A6	861155A6	160	REC87-19674A1	87-19674A1	180	REC8M0052939		264
REC861156A03	861156A03	161	REC87-805605A1	87-805605A1	171	REC8M0054726	881731	169
REC861156A1	861156A1	159	REC87-808009A2	87-808009A2	264	REC8M0054726	8M0054726	169
REC861249A1	861249A1	169-173-174	REC87-808009A2	87-808009A2	264	REC8M0054726		174
REC861578	861578	264	REC87-808009A2	87-8M0052935	264	REC8M0058164	97401	158
REC861677T	818383T	157	REC87-808009A2		264	REC8M0058164	8M0058164	158
REC861677T	861677T	157	REC87-814281A5	87-814281A5	264	REC8M0058164		159
REC861677T		159	REC87-858679T2	87-858679T2	180	REC8M0061381	860256A4	191
REC862030T01	862030T	177	REC87-858679T2	87-858679T2	180	REC8M0061381	861006A1	191
REC862030T01	862030T01	177	REC87-859032T02	87-859032T02	180	REC8M0061381	8M0061381	191
REC862031T1	862031	177	REC87-864252	87-864252	172	REC8M0061381	32-8M0062102	205-267
REC862031T1	862031T	177	REC87-864252A01	87-864252A01	172	REC8M0062102	8M0062770	160-161
REC862031T1	862031T1	177	REC87-892150Q02	87-892150Q02	187	REC8M0062770		171
REC862048A1	862048A1	157	REC87-91941A8	87-91941A8	180	REC8M0068784	34623	171
REC862048A1	97399	157	REC87-91941A8	8M0032176	180	REC8M0068784	90806	171
REC862048A1	812454A1	157	REC876037	8M0057697	180	REC8M0068784	815425	171
REC862048A1	812454A3	157	REC879150054		151	REC8M0068784	87-815425T	171
REC862048A1	862048A1	157	REC879150A65	879150A65	262	REC8M0068784	8M0068784	171
REC862048A1	97399A2	157	REC879150A65	8M0039340	262	REC8M0073435	842725A3	158
REC862048A1		159	REC879150A65AL	879150A65	262	REC8M0073435	861676A1	158
REC862077A1	41141A2	157	REC879150A65AL	8M0039340	262	REC8M0073435	861676T09	158
REC862077A1	862077A1	157	REC879172	879172	156	REC8M0073435	8M0073435	158
REC862077A1		159	REC879172	896332162	156	REC8M0073435		159
REC862210A01	22-862210A01	226-227-229-235-237	REC879172		151	REC8M0077616	805544T	170
REC862344A	47585	158	REC879194185	879194185	194	REC8M0077616	8M0077616	170
REC862344A	71327	158	REC879194401	46-879194401	196	REC8M0077616		174
REC862344A	77594	158	REC879194401	8M0094406	196	REC8M0079291	8M0079291	189
REC862344A	86234	158	REC879194401	8M6005225	196	REC8M0080805	8M0080805	263-267-273-274
REC862344A	8623405	158	REC879194401		197	REC8M0080805		169
REC862344A	86234A3	158	REC881693002	881693002	162-174	REC8M0087834	885165	169
REC862344A	86234A4	158	REC881879T11	859210	171	REC8M0087834	8M0087834	169
REC862344A		159	REC881879T11	881879011	171	REC8M0089715	807252T1	193
REC862351T	862351T	196	REC881879T11	859210T	171	REC8M0089715	8M0089715	193
REC86246T	71646	158	REC881879T11	859604A1	171	REC8M0089715		148-149-150
REC86246T	78485	158	REC881879T11	881879A6	171	REC8M0091470	807252T2	192
REC86246T	86246	158	REC881879T11	881879T11	171	REC8M0091470	8M0091470	192
REC86246T	86246A1	158	REC882376	882376	155	REC8M0091470		148-149-150
REC86246T	86246T	158	REC882687	882687	156	REC8M0092849	8M0092849	180
REC86246T		159	REC882687	35-8M0150917	156	REC8M0093480	8M0066646	192
REC86247T	46860	158	REC882751A04	821509	179	REC8M0093480	8M0067292	192
REC86247T	63196	158	REC882751A04	821509T01	179	REC8M0093480	8M0093480	192
REC86247T	78820	158	REC882751A04	882751A04	179	REC8M0093480		151
REC86247T	86247	158	REC883710A02	883710A02	188	REC8M0093561	879194215	192
REC86247T	86247A2	158	REC883710A02		188	REC8M0093561	879194231	192
REC86247T	86247T	158	REC885176	885176	162-173-174	REC8M0093561	879194233	192
REC86247T		159	REC89-96054T	89-91975	179	REC8M0093561	896332148	192
REC862998	862998	170-173-174-224	REC89-96054T	89-96054	179	REC8M0093561	8M0093561	192
REC863077T	863077T	178	REC89-96054T	89-96054T	179	REC8M0093561		151
REC863077T	86307AR01	178	REC89-96158T	89-96158	179	REC8M0095310	8M0095310	171-265-269
REC86310	16755Q1	256	REC89-96158T	89-96158T	179	REC8M0095953	8M0095953	230
REC863802T2	863802T2	191	REC892451T06	892451T06	190	REC8M0098619	889341	168
REC864244A2	864244A2	256	REC892451T10	892451T10	190	REC8M0098619	8M0098619	168
REC864297T01	864297	171	REC892451T20	892451T20	190	REC8M0098619		168
REC864297T01	864297001	171	REC892617	892617	171	REC8M0100483	8M0100483	189
REC864297T01	864297T01	171	REC892681	892681	161-162-174	REC8M0100485	8M0100485	189
REC864493	864493	148-149-150-193	REC892984A02	892984A02	188	REC8M0101601	8M0101601	276
REC864572	864572	153	REC892984K32	892984K32	190	REC8M0101601	8M0101603	276
REC864572	35-864572	153	REC893353A03	893353A03	180	REC8M0111642	898101425	204
REC864572		150	REC893378A02	893378A02	190	REC8M0111642	8M0111642	204
			REC895207	895207	156-194	REC8M0113182	8183812	204
						REC8M0125617	805226A1	169

REF	OEM		REF	OEM	
REC8M0125617	881070T	169	REC98-8M0121940	98-8M0121940	200
REC8M0125617	8M0125617	169-224	REC98230A1	98230A1	265-269
REC8M0133370	8M0057679	161	REC984491	802416	153
REC8M0133370	8M0133370	161	REC99155T2		149-150
REC8M0142542	8M0142542	173	REC99370A2	99370A2	242
REC8M0142695	8M0095468	170-230	RECBS40013	58203	217
REC8M0142695	8M0142695	170	RECBS40013	814622	217
REC8M0144930	8M0144930	180	RECBS40013	26-814622	217
REC8M0148530	854179001	196	RECBS40013	FI5110026	217
REC8M0148530	879312023	196	RECEFP-KT		160
REC8M0148530	8M0148530	196	RECGS01030		151
REC8M0148668	885342001	173	RECK309		226-231
REC8M0148668	885342002	173-230-232	RECK591		226-231
REC8M0148668	8M0148668	173-224	RECKITALPHAI		151
REC8M0153706	807729T	204	RECKITBRAVO		151-152
REC8M0153706	8M0153706	204	RECKITMBRAVO23AL		152
REC8M0155633	897345016	196	RECKITMBRAVO3AL		151-152
REC8M0155633	8M0129714	196	RECKITGENEII		151
REC8M0155633	8M0155633	196	RECKITMALPHA1AL	888756Q04	151-152-245-247-249-260-262
REC8M2003959	8M2003959	170-224-230-232	RECKITMALPHA1M	888756Q04	260-262
REC8M2004414	8M2004414	230-232-241	RECKITMALPHA1ZN	888756Q04	260-262
REC8M2015937	8M2015937	251-253	RECKITMALPHA2AL	888756Q03	151-152-251-253-255-260-262
REC8M2015938	8M2015938	251-253	RECKITMALPHA2M	888756Q03	260-262
REC8M6000623	8818793	172	RECKITMALPHA2ZN	888756Q03	260-262
REC8M6000623	881879010	172	RECKITMBRAVO1AL	888758Q02	256-257-160-262
REC8M6000623	8M6000623	172	RECKITMBRAVO1M	888758Q02	260-262
REC8M6000634	889659002	171	RECKITMBRAVO1ZN	888758Q02	260-262
REC8M6000634	897447002	171	RECKITMBRAVO23AL	888761Q03	258-260-262
REC8M6000634	8M6000634	171	RECKITMBRAVO23M	888761Q03	260-262
REC8M6002428	8M0057686	162	RECKITMBRAVO23ZN	888761Q03	260-262
REC8M6002428	8M6000652	162	RECKITMBRAVO3AL	888761Q04	259-260-262
REC8M6002428	8M6002428	162	RECKITMBRAVO3M	888761Q04	260-262
REC8M6003194	878187	170	RECKITMBRAVO3ZN	888761Q04	260-262
REC8M6003194	8M6003194	170	RECKITMMPHA1M	888756Q04	262
REC8M6500024	865598	204	RECKITMMPHA2M	888756Q03	262
REC8M6500024	8M6500024	204	RECMC00004	47-89984Q5	199
REC909048	802149	220	RECPG260		175
REC909139	802149	220	RECRK21069		157
REC909140	58390	220	REC27-815528	27-815528	224
REC909140	802151	220	RM10-25299	10-824941	222-223-225-233
REC909140	25-58390	220	RM12-41721	12-41721	265-269
REC91-12037	91-12037	275	RM21325765	864148	168
REC91-17256	91-17256	275	RM21325765	801331174	168
REC91-25034		275	RM21325765	801763272	168
REC91-43579	91-43579	275	RM21325765	54-896332164	168
REC91-45497A1	91-45497A1	276	RM21325765	864148A01	168
REC91-78310	91-78310	275	RM21325765		168
REC91-805475A1	91-805475A1	275	RM22-861163	22-861163	194-266-268
REC91-818162	91-818162	276	RM23-804982	23-804982	221
REC91-888863	91-888863	186	RM23-847638	23-847638	269
REC910238	802383	220	RM23-98356	23-98356	263-267
REC938-7499	7358	216	RM23-983571	23-983571	263-267
REC938-7499	938-4625	216	RM27-864549A02	27-864549A02	242
REC938-7499	938-7358	216	RM35-866594Q01	35-866594K01	153
REC938-7499	938-7499	216	RM35-866594Q01	35-866594Q01	153
REC938-7499	FI1101190	216	RM35-866594Q01		148
REC938-803860T	883297	216	RM3853825	3853825	272
REC938-803860T	883297R1	216	RM46-807151A8	46-72774A69	196
REC938-803860T	883297R50	216	RM46-807151A8	46-807151A8	196
REC938-803860T	8M0188302	216	RM57-862054Q		148-201
REC938-803860T	938-803860T	216	RM733-810852	38191	221
REC938-803860T	938-883297R1	216	RM733-810852	810852	221
REC938-803860T	938-8M0115137	216	RM733-810852	733-803850T	221
REC938-8M0087884	802556T	216	RM733-810852	733-810852	221
REC938-8M0087884	8M0087884	216	RM733-810852	803850T	221
REC938-8M0087884	938-802556	216	RM806193A48	19742A1	194
REC938-8M0087884	938-8M0087884	216	RM806193A48	19742A3	194
REC94286T1	94286	261	RM806193A48	806193A20	194
REC94286T1AL	94286	261	RM806193A48	806193A38	194
REC94576	94576	197	RM806193A48	806193A48	194
REC94576	8M0204674	197	RM810845	810845	220
REC966900	57-77274	205	RM810845	810845T	220
REC966903	57-74271Q	201-202-205	RM810845	8M0122492	220
REC966931	57-13458Q	202-203-205	RM863444T1	863444T1	191
REC97258A1	34625	172	RM863631T1	863631T1	191
REC97258A1	97258	172	RM91-17273	91-17273	275
REC97258A1	97258A1	172			
REC97258A1	FI6900152	172			
REC97258A1	FI6900198	172			

## POLÍTICA DE GARANTÍA RECMAR

Todos los productos comercializados por **RECMAR** deben ser instalados y utilizados por personal competente bajo su exclusiva responsabilidad. **RECMAR** no se responsabiliza de las consecuencias producidas por una instalación defectuosa o inapropiada de ningún artículo que no incluya soluciones de instalación.

El instalador será el responsable de verificar la correcta aplicación de las recomendaciones del fabricante en cuanto a compatibilidades de uso.

Los artículos comercializados por **RECMAR** están amparados por la garantía legal.

**RECMAR** distribuye los artículos presentes en sus catálogos únicamente a profesionales, nunca a particulares o cliente final, el importe de la instalación jamás estará incluido en el precio por lo que no será responsable de ésta.

Los artículos comercializados por **RECMAR** disponen de una garantía limitada por defectos de fabricación, los periodos pueden variar entre los 3 años y los 3 meses, descartando los artículos considerados como consumibles: productos eléctricos, baterías y otros que carecen de periodo alguno, si necesita conocer el plazo exacto del producto contacte con el departamento comercial.

El material que enviamos diariamente desde **RECMAR** a nuestros clientes es examinado antes de empaquetarse para su perfecta integridad y evitar daños en el transporte. Recuerde que es muy importante inspeccionar las cargas en presencia del transportista. Cuando se observen daños en la caja, deberá incluirse en el albarán de entrega del transportista una mención del tipo (CONFORME MERCANCÍA, SALVO INSPECCIÓN), y deberá ser firmada por usted y el transportista. En caso de recibir material defectuoso por estas causas debe hacerlo constar tanto al transportista como a **RECMAR** para poder reclamar a la empresa de transporte correspondiente.

## SOLICITUD DE GARANTÍA

La garantía siempre estará sujeta a la valoración final del departamento técnico de **RECMAR**. Esta valoración se llevará a cabo en nuestras instalaciones o en caso necesario por el fabricante del artículo, en ambas opciones el artículo tiene que estar físicamente en nuestras instalaciones centrales de Viladecans. El tiempo para la resolución será un máximo de 30 días naturales desde su recepción.

Para enviar el artículo defectuoso, debe ir a la página web [www.recambiosmarinos.es](http://www.recambiosmarinos.es), o [www.usarecmar.com](http://www.usarecmar.com) ir a su cuenta y seleccionar TRAMITAR GARANTÍA dentro del área privada, desde aquí podrá descargar el archivo para la solicitud de garantías de motores y piezas, y seguir las instrucciones.

**RECMAR** no asumirá ningún préstamo de reemplazo durante el proceso de garantía.

## EXCLUSIONES DE GARANTÍA

**RECMAR** no podrá ser acusado como responsable del defecto ante:

- Desgaste normal del producto.
- Defectos de instalación o uso inadecuado.
- Instalación de un artículo no destinado a ese modelo.
- Daños por causa externa (accidente, rayo, fluctuación de corriente...)
- Defectos y consecuencias relacionadas con el transporte.
- Alteraciones en instalaciones o barcos destinados a la competición.

En caso de rechazo de la garantía, el cliente tiene la posibilidad de recuperar su artículo defectuoso poniéndose en contacto con nosotros vía e-mail solicitando la devolución del mismo dentro de los 7 días naturales siguientes a la fecha en que se le informó del rechazo de garantía.

**RECMAR** no forma parte de las garantías comerciales anunciadas en ocasiones por los fabricantes.

## RECMAR WARRANTY POLICY

All products sold by **RECMAR** must be installed and used by competent personnel under their exclusive responsibility. **RECMAR** shall not be responsible for the consequences of the faulty or improper installation of any item that does not include installation solutions.

The fitter will be responsible for checking that the manufacturer recommendations have been followed correctly in terms of compatible uses.

Articles sold by **RECMAR** are covered by legal warranty.

**RECMAR** distribute the products only to professionals and never to private final clients. The cost of installing the part would never be included in the price for which reason, **RECMAR** would never be responsible for its installation.

Articles sold by **RECMAR** are covered by warranty for manufacturing defects for a limited period of time that may vary between 3 years and 3 months, except for the articles considered consumable, electrical products, batteries and others that are not covered at all. For information on the exact warranty period of an article, please contact the Sales Department.

The goods that **RECMAR** sends every day to its customers are examined before being packed to ensure their perfect integrity and avoid damage during shipping. Remember that it is essential to check the goods in the presence of the dispatcher. If the package is damaged, the dispatcher's delivery note must mention what type (CONFORMING GOODS, UNLESS INSPECTED), and must be signed by you and by the dispatcher. If you receive damaged goods for these reasons you must notify both the dispatcher and **RECMAR** to be able to make the claim to the relevant delivery company.

## WARRANTY CLAIMS

Warranties are always subject to **RECMAR** Technical Department's assessment. The assessment will be carried out on **RECMAR**'s premises or, if necessary, by the article's manufacturer. In both cases, the article must be physically on **RECMAR**'s premises in Viladecans. Assessment time will not exceed 30 calendar days from receiving the article.

To return the faulty item, visit [www.recambiosmarinos.es](http://www.recambiosmarinos.es), or [www.usarecmar.com](http://www.usarecmar.com), go to your account and select PROCESS WARRANTY in the private section. From there you will be able to download the file to claim the warranty of engines and parts and follow the instructions.

**RECMAR** will not charge for the loan of the replacement during the warranty process.

## WARRANTY EXCLUSIONS

**RECMAR** shall not be responsible for product faults in the following cases:

- Normal wear and tear of a product.
- Installation faults or improper use.
- Installation of an article not designed for the model in question.
- Damage due to external causes (accidents, lightning, power surges...)
- Defects and consequences of transport.
- Alterations to installations or to boats intended for competitions.

If the warranty is refused, the customer may retrieve the faulty article by contacting **RECMAR** via email and requesting that the article is returned to them within 7 calendar days from the day the warranty was refused.

**RECMAR** does not apply the warranties offered from time to time by manufacturers.



**RECMAR**  
USA

1917 NW 79 Ave  
Miami, FL 33126

Ph. 786-962-5020

[info@usarecmar.com](mailto:info@usarecmar.com)

[www.usarecmar.com](http://www.usarecmar.com)

**RECMAR**<sup>®</sup>

Jocelyn Bell, 26  
08840 Viladecans  
Barcelona

phone: (+34) 93 662 66 55

[info@recambiosmarinos.es](mailto:info@recambiosmarinos.es)  
[www.recambiosmarinos.es](http://www.recambiosmarinos.es)

[www.recmar.es](http://www.recmar.es)