



PLASTIMO

HAPPY BOATING TO YOU !

2026 / 2027

www.plastimo.com





WELCOME TO PLASTIMO'S UNIVERSE

For over 60 years, our company has been both a witness to and a driving force behind developments in the nautical sector. Building on its rich history, it has successfully adapted to market requirements while remaining true to its core values : safety, ergonomics, service and enjoyment.



CONSTANT INNOVATION, OUR DRIVING FORCE

In a sector that is constantly evolving, we have always been able to anticipate and satisfy market expectations. Innovation is part of our DNA: every product we create or distribute is the result of research and development. We strive to push the boundaries of technology to offer our customers equipment that is increasingly efficient, durable and adapted to their needs.



EXPLORE OUR CATALOGUE, DESIGNED FOR YOU

Discover in this catalogue a selection of carefully chosen products, the result of our expertise and our collaborations with leading brands, as well as our own production. As a manufacturer, we design and manufacture a wide range of products in Lorient. Whether you are a boating enthusiast or a sector professional, you will find the equipment that meets your requirements here.



HUMAN BEINGS AT THE HEART OF OUR EXPERTISE

Behind every Plastimo product are women and men driven by excellence. Their expertise, passion and commitment are the foundations of our success. It is thanks to them that we are constantly innovating and developing lasting trust-based relationships with our customers.



STRONG PARTNERSHIPS, BASED ON TRUST

Over the years, we have built strong relationships with brands that, like us, focus on quality and innovation. These partnerships, which are renewed and strengthened at every stage, enable us to offer our customers the very best products. Together, we share the same vision: to make every boating experience unique and memorable, ensuring safety, performance and enjoyment.



OPERATING IN
MORE THAN
90
COUNTRIES

OVER
60 YEARS
OF EXPERIENCE

7500 M²
LOGISTICS
WAREHOUSE



ISO 9001 CERTIFICATION

Plastimo is ISO 9001 certified, demonstrating our commitment to excellence and continuous improvement. This certification reflects the stringency of our quality system, guaranteeing products and services that meet the most rigorous requirements. It strengthens the confidence of our customers and partners by attesting to our ability to innovate and optimise our processes. By placing customer satisfaction at the heart of our approach, we ensure sustainable performance and unrivalled reliability. Thanks to this commitment, our brand stands out in the market and offers superior quality solutions adapted to everyone's needs.



DISCOVER OUR WEBSITE

WWW.PLASTIMO.COM

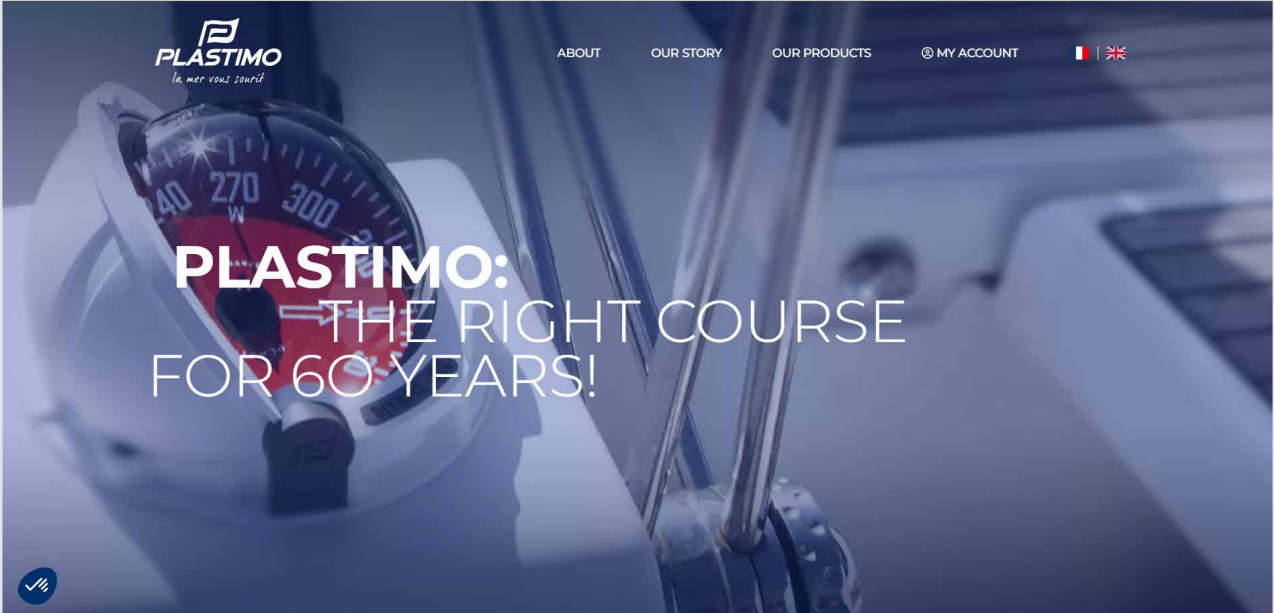

ABOUT OUR STORY OUR PRODUCTS MY ACCOUNT  

PLASTIMO:
THE RIGHT COURSE
FOR 60 YEARS!



FOR OVER
60 YEARS

our brand has been following sailors around the world. Discover all the key dates in our history.

EASILY
ACCESS

the list of our dealers and service stations around the world.

REGISTER YOUR
LIFERAFTS

online.

EXPLORE OUR **PRODUCT** RANGES
with their detailed descriptions.



1963

Plastimo was born with the growth of modern recreational boating. In 1963, Antoine Soubert believes that a real opportunity exists to make something more available to the sport: rafts, and more precisely inflatable rafts. He creates Plastimo on the island of Ré, Brittany. A 24-page catalogue showcasing 40 products. Plastimo registers a 25.5% growth every year until 1970 and employs 55 people in 1966. The "Green Card" (ownership) and its 4 must-haves are born and become the common standard in the most prestigious French sailing clubs until the 1970s.



1970

Safety at sea. The brand's first stretch net, immediately. Historical partnership group quality in France with Plastimo and leaders. The initial family business turns into an international company with 8000 B & C Equipments. Plastimo awarded the "Helmuth" CTR de Récompense in 1970. Plastimo issues its first export catalog. The catalogue now features 2000 products, out of which 50% is now manufactured in France by a 100 and some.



Jeweller's craftsmanship and competition from our Liferaft division. The manufacturer department is created. The birthplace of the Lorient range: rope, inflatables, the first inflatable entirely manufactured in plastic and featuring the unique double-bubble both cockpit and cabin. The brand product comes from the 1976: the first recreational accessories and painting Plastimo as the first European sailing manufacturer. In 1976, the compass range includes models made from complex composite materials, specifically designed for recreational boating and sailing. It has been 50 years since the first instruments in regular glass.

PLASTIMO
happy boating to you!

A TEAM BY YOUR SIDE



PLASTIMO
INTERNATIONAL SALES CONTACT
exportsales@plastimo.com

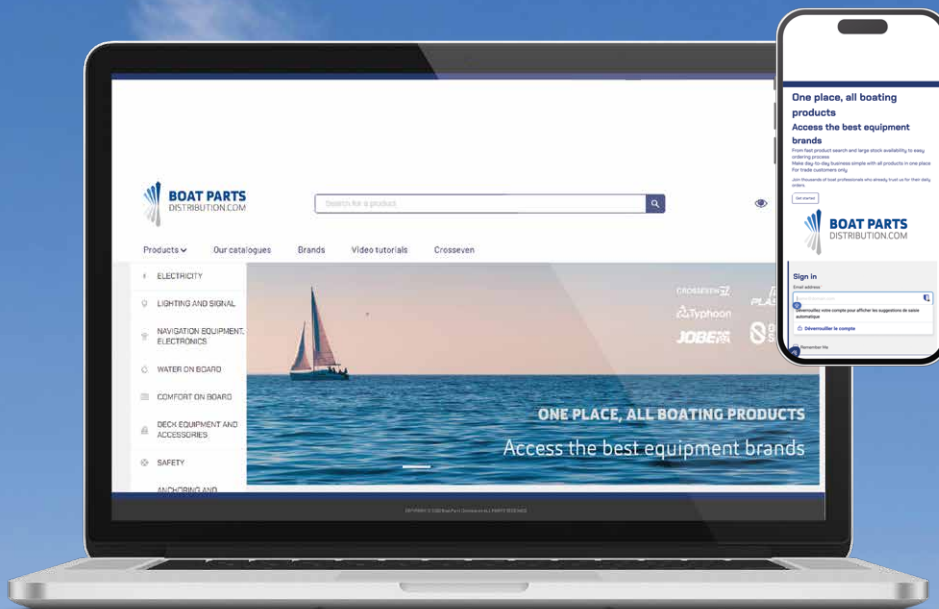

VISIT US ONLINE

DISCOVER THE ENTIRE PLASTIMO RANGE AT WWW.BOATPARTSDISTRIBUTION.COM

- Discover our entire range of products in just a few clicks
- View all our catalogues in digital format
- View your professional rates and recommended retail prices
- Order your spare parts with ease
- Check stock availability and replenishment dates
- Create a multi-profile account for your team, manage your shopping carts, and centralise your delivery and billing addresses



DISCOVER OUR RANGE OF MERCHANDISING PRODUCTS DESIGNED TO MEET YOUR NEEDS.



FOR ADDITIONAL INFORMATION, PLEASE CONTACT YOUR SALES REPRESENTATIVE.

CONTENTS

15 SAFETY

- | | | | |
|-------|---|----|-------------------------------------|
| 18 | Recreational boating inflatable lifejackets | 55 | Audible and visual signalling |
| 27 | Professional inflatable lifejackets | 56 | Floating lights |
| 39 | Foam lifejackets | 59 | Safety knives |
| 30/42 | SOLAS inflatable and foam lifejackets | 60 | Bailing |
| 42 | Bosun's chairs | 61 | Safety ladders |
| 43 | Safety harnesses | 61 | Floating anchors |
| 44 | Lanyards | 62 | First aid kit |
| 46 | Lifelines | 64 | Drinking water and survival rations |
| 47 | Rescue range | 65 | Survival |
| 48 | Horseshoe lifebuoys | 66 | Grab bags |
| 50 | Ring buoys | 67 | Equipment bags |
| 52 | IOR poles | 68 | Pyrotechnics |
| 54 | Buoyant cushions | 69 | Liferafts |
| 54 | Lifeguard rescue buoy | | |

87 WATER ON BOARD

- | | | | |
|----|------------------------|----|----------------|
| 88 | Water pressure system | 93 | Flexible tanks |
| 89 | Manual bilge pumps | 95 | Deck showers |
| 92 | Fixed freshwater tanks | 98 | Faucets |

99 MOORING

- | | | | |
|-----|-------------------------|-----|-----------------------|
| 100 | Tenders | 134 | Bollards |
| 109 | Jockey console | 136 | Ropes |
| 121 | Davits | 139 | Fenders |
| 121 | Cargo boom assembled | 145 | Bumpers |
| 122 | Hand propulsion systems | 147 | Inflatable race buoys |
| 124 | Boat hooks | 149 | Ladders |
| 127 | Anchors | | |

157 NAVIGATION

- | | | | |
|-----|-------------------------------------|-----|------------------------|
| 158 | Heading compasses | 192 | AIS Transceivers |
| 178 | Tactical compasses | 193 | Navigational equipment |
| 179 | Specialty compasses | 194 | VHF Radios |
| 180 | Compasses for kayak and small boats | 199 | Chart table equipment |
| 181 | Handbearing compasses | 200 | Marine binoculars |
| 186 | GPS | 203 | Barometers |
| 187 | Onboard navigation | 205 | Codes and signals |
| 191 | Sensors | | |

207 COMFORT**208** Cowl vents and dorade boxes**210** Fabric windsocks**211 ELECTRICITY****212** Handheld spotlights**213** LED torches**215** Headlamps**217 CHANDLERY****218** Deck equipment**219** Jib reefing**223** Wires and shrouds**225** Chainplates**227** Pad eye, nut and eye bolt**230** Handrails**231** Deck mounting hardware**232** Deck hatches**236** Padlocks and latches**237 ENGINE ENVIRONMENT****239** Marine engine accessories**239** Fuel system**244** Ventilation**250** Outboard motor bracket**251** Boat covers



© Guillaume Gaterait



© Guillaume Gaterait



© JM Liot-Alea-Disobey-Macif



© Polaryse - Julien Champollon

A World Solo Round-The-World record in 2017, winner of the Transat Jacques Vabre (2015) and Bakerly (2016), François Gabart contributed his expertise by testing the new SLR 196 life jacket in real conditions alongside Tom Laperche on the Ultim SVR Lazartigue. **B** Charlie Dalin, winner of the last Vendée Globe (2024/2025), embodies excellence, performance and the values we share through our commitment to him. **C** Yoann Richomme, two-time winner of the Solitaire du Figaro (2016 and 2019) and two-time winner of the Route du Rhum (2018 and 2022) in the Class 40 category. In Imoca, he is the winner of the Retour à la Base 2023 and The Transat 2024. On 15 January 2025, he crossed the finish line of the 2024-2025 Vendée Globe in second place.



INSPIRED BY CHAMPIONS

To ensure that sailors benefit from the latest developments in products tested under the most extreme conditions, Plastimo has always enjoyed the collaboration of the most successful racers. Their demands stimulate our creativity and their successes drive our ambitions: a real motivation for our technicians to raise the bar always higher.



RESEARCH AND DEVELOPMENT

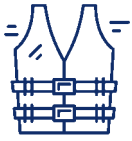

SAFETY

At the heart of the brand's DNA, as evidenced by the lifejackets, tethers and harnesses developed by the R&D department in Lorient. From ladders to fenders, inflatable dinghies to bilge pumps, safety is at the heart of every Plastimo design.



ERGONOMICS

At sea, simplicity is key. Even the most innovative product is only valuable if it is intuitive to use and ergonomic. For Plastimo, ergonomics contributes to the correct use of the product, and is therefore a guarantee of quality... and safety.



SAILORS RE-INVENT SAILING PRACTICES, PLASTIMO RE-INVENTS EQUIPMENT



JM Liot©



JM Liot©

Tom Laperche, French offshore racing champion.
Figaro Bénéteau 3 equipped with Plastimo airbags.



SERVICE

Our presence on the market for over 60 years has given us maturity and a perfect knowledge of market and boaters's needs. Plastimo is aware of changes in practices and boats, and the requirements of its customers. More than ever this year, the key words will be adapted and efficient logistics, and a sales team that listens to our professional network.



ENJOYMENT

We always keep your objective in focus: the pleasure of enjoying the sea with complete confidence. Whether you are a yachtsman who wants to enjoy a successful family cruise, a competitive sailor who never gives up, or a professional keen to satisfy your customers, we all share the sea as a link to escape and good times together.

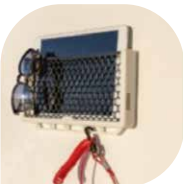
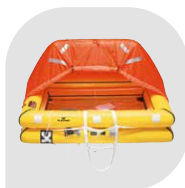

DESIGNER AND MANUFACTURER SINCE 1963



© POLARYSE - Julien Champollion

SAFETY

Recreational boating inflatable lifejackets ...	18	Audible and visual signalling	55
Professional inflatable lifejackets	27	Floating lights	56
Foam lifejackets	39	Safety knives	59
SOLAS inflatable and foam lifejackets	30/42	Bailing	60
Bosun's chairs	42	Safety ladders	61
Safety harnesses.....	43	Floating anchors	61
Lanyards	44	First aid kit	62
Lifelines	46	Drinking water and survival rations	64
Rescue range	47	Survival	65
Horseshoe lifebuoys	48	Grab bags	66
Ring buoys	50	Equipment bags	67
IOR poles	52	Pyrotechnics	68
Buoyant cushions	54	Liferafts	69
Lifeguard rescue buoy	54		



BUOYANCY AIDS AND LIFEJACKETS

A lifejacket is a piece of personal protective equipment (PPE). When worn and used correctly, it helps to increase the chances of survival in the event of falling into the water.





It must be chosen based on various criteria:

- **Legal requirements** in force in the country and for the activity practised (cruising, regattas, seaside activities, maritime professions and professional activities, etc.)
- **Conditions of use** (type of boat, frequency of use, dirty environment, sitting position, etc.), which determine the points to be prioritised: comfort, flexibility, buoyancy, robustness.
- **Body type** (adult, child, build) and clothing or equipment worn with the lifejacket (coastal or work clothing, etc.)
- And, of course, **your own tastes and preferences!**

EUROPEAN STANDARDS & DIRECTIVES

Buoyancy aids and lifejacket must meet the requirements of:

- European standard ISO 12402.
 - European regulation EU 2016/425 on PPE (Personal Protective Equipment).
- The essential CE marking indicates that the jacket is compliant.

	50 Newton buoyancy aid  EN ISO 12402-3	100 Newton lifejacket  EN ISO 12402-4	150 Newton lifejacket  EN ISO 12402-3	275 Newton lifejacket  EN ISO 12402-2
Use Category	Coastal navigation, coastal shipping, beach activities. For experienced swimmers.	Coastal and sheltered waters navigation.	Offshore navigation.	Offshore navigation, extreme conditions and professional use.
Type of boat	Canoeing, windsurfing, dinghy sailing, water skiing, jet skiing, kitesurfing, stand-up paddle.	Sailing ships and motor vessels.	Sailing ships and motor vessels.	Sailing and motor vessels, industrial and commercial vessels.
Performances	Does not ensure turning over. Ensures that the respiratory tract remains above water for a conscious wearer.	Ensures reversal in 10 seconds*	Ensures reversal in 5 seconds*	Ensures reversal in 5 seconds*, even when wearing heavy protective clothing (recommended for clothing that may trap air).
Reflective material	Optional	Surface area 100 cm ²	Surface area 300 cm ²	Surface area 400 cm ²
Whistle	Optional	Mandatory	Mandatory	Mandatory
Rescue loop	Optional	Optional	Mandatory	Mandatory
Crutch strap	-	Useful	Useful	Useful

*of most users.



SOLAS

When are SOLAS lifejackets required?

SOLAS-approved lifejackets are used on board commercial or passenger vessels (including pleasure boats over 25 m). They must meet the requirements of the European Directive on marine equipment SOLAS-MED 2014/93/EU.



GOOD TO KNOW

Which life jacket should I choose based on my weight and height?

Check the size, weight and chest measurements indicated on the lifejacket label. Be sure to try on the lifejacket before purchasing it.

REMEMBER: a lifejacket is worn OVER clothing and must fit properly.







Particular case of young children

Children weighing less than 30 kg must wear a category 100 N lifejacket in accordance with regulations. When cruising offshore or practicing seashore activities, a child's lifejacket must ensure that the wearer will turn safely on his/her back and must also feature retro-reflective tapes for visibility and a grab loop.

INFLATABLE LIFEJACKETS

Which inflation mechanism?

As a designer and manufacturer of lifejackets for over 50 years, Plastimo provides you with some key information to help you better understand how your inflatable lifejacket works and choose the model that suits you best for your application.

Type of inflation	How does it work?	Use / Type of activity
 BUCCAL	By blowing air.	Auxiliary or emergency inflation, mandatory on all inflatable lifejackets. Allows pressure to be adjusted during use and the lifejacket to be deflated after impact.
 MANUAL	The user pulls the percussion cord. The cylinder is pierced, releasing the CO ₂ into the inner tube.	Activities involving frequent or repeated immersion (beginner paddle boarders, abseiling team members, etc.).
 AUTOMATIC	The cartridge contains a water-soluble component that dissolves on contact with water, releasing the percussion system from the cylinder and thus the CO ₂ into the inner tube.	Essential if the user cannot swim. Highly recommended in general, as it provides optimum safety: immediately operational even if the person overboard is unconscious.
 AUTOMATIC PRO-SENSOR	Same operation as the automatic system.	Same use as the automatic system. Combined with a window on the vest cover: the indicators on the impact head allow you to quickly check the operational status of the system at any time. Essential for inexperienced users.
 HAMMAR HYDROSTATIC	When the trigger is submerged, the hydrostatic valve opens. Water comes into contact with a water-sensitive membrane, which triggers the CO ₂ cylinder to be activated.	Activities where the lifejacket may be subjected to significant or frequent water splashes (regattas, sailing in difficult conditions, etc.). Performance may be limited if the valve is not sufficiently submerged.

THE 'PLUS' IN SAFETY:
All lifejackets, including automatic models, can also be activated MANUALLY.
All lifejackets are equipped with a mouthpiece for additional inflation.

The various equipment and accessories



INTEGRATED HARNESS

Reduces the risk of man overboard: only a lifejacket with an integrated harness has the stainless steel buckle or textile ring that allows you to attach the lanyard connecting you to the boat. Essential for night sailing or in rough seas, for bow crew or in regattas, and for solo sailing. Also highly recommended for children.



With harness



Without harness



CRUTCH STRAP

Prevents the inflated vest from riding up and makes swimming easier.

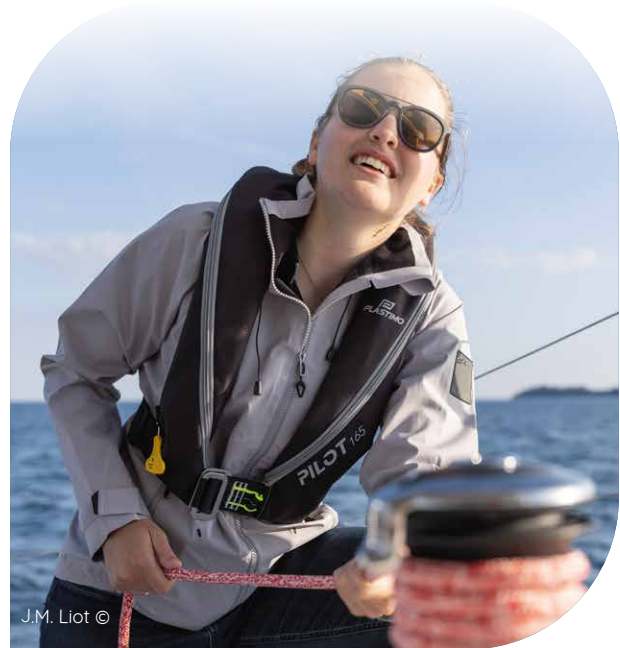

J.M. Liot ©



SPRAYHOOD

Protection placed in front of the face to protect the airways from waves or spray. Greatly improves survival in rough seas (also known as a hood).



HOW TO CHOOSE YOUR INFLATABLE LIFEJACKET?

GOOD TO KNOW

- All our lifejackets are equipped with the following standard safety features:
- Whistle
 - 25 mm polypropylene strap tow handle (for grabbing the rescued person and pulling them out of the water)
 - Retro-reflective tape
 - Buccal inflation valve



	SLR 196	PILOT 165	EVO 165
Actual buoyancy	196 N	165 N	165 N
Performance level (standard)	150 N (EN ISO 12402-3)	150 N (EN ISO 12402-3)	150 N (EN ISO 12402-3)
Inflation (CO₂ cylinder)	38 g	33 g	33 g
Firing Mechanism	Manual only	✓	✓
	UML MK5 automatic water-soluble cartridge	✓	-
	UML Pro Sensor automatic water-soluble cartridge	-	-
	UML Elite automatic water-soluble cartridge	✓	✓
	Hammar automatic hydrostatic	✓	✓
Lifejacket's closure	Aluminium 'Stab lock' buckle	316L stainless steel or polyamide and fibreglass double push-button buckle	
Waist size	60-150 cm	55-140 cm (XXL : 55-175 cm)	60-130 cm
Quick-adjust belt	-	-	-
Integrated harness (EN ISO 12401)	Textile buckle	Textile buckle with retro-reflective thread	
Crutch Strap	Double, included	According to model	Double, included
Outer cover	Closure	QBZ® zip	Zip
	Main fabric	Extra flexible polyester	
	Retro-reflective element	✓	-
	Viewing window	✓	-
	Zip pocket	✓	-
Sprayhood (EN ISO 12402-8)	According to model	Option	Option
Key features	<ul style="list-style-type: none"> - Neoprene collar - Belt with 5 presets - Easy-to-fold cover and inner tube - Quick release valve - Molle® strap for accessories 	<ul style="list-style-type: none"> - Extra flexible, technical fabric - Lightweight, ergonomic vest - Easy-to-put-on harness - Refined, optimised fit 	<ul style="list-style-type: none"> - Short teardrop cut - Pull-over design - Comfort patch on the front
Compatible flashlights		<ul style="list-style-type: none"> - Lonako SL3 ref. 2263071 / ref. 2263075 - Daniamant W3 ref. 60833 	
Compatible beacons		<ul style="list-style-type: none"> - MOB 1 (ref. 67778) - MOB2 (ref. P205314) - PLB3 (ref. 71155) 	
Lifejacket weight (from ... g / ex. manual model without harness)	1100	690	890
Recommended use	Offshore and recreational boating	Multi-activity, frequent use	Multi-activity, active use



NEO 165	NEO 165 FISHERMAN	PILOT 180	PILOT 300	EVO J (Junior)	NEO J (Junior)
165 N	165 N	180 N	300 N	110 N	110 N
150 N (EN ISO 12402-3)	150 N (EN ISO 12402-3)	150 N (EN ISO 12402-3)	275 N (EN ISO 12402-2)	150 N (EN ISO 12402-3)	150 N (EN ISO 12402-3)
33 g	33 g	38 g	60 g	24 g	24 g
✓	✓	✓	-	-	-
✓	✓	-	-	✓	✓
-	-	-	-	-	-
-	-	✓	✓	-	-
✓	-	-	✓	-	-
316L stainless steel or polyamide and fibreglass buckle	Polyamide and fibreglass buckle	316L stainless steel or polyamide and fibreglass buckle		316 stainless steel buckle	
55-140 cm		55-175 cm		30-110 cm	30-90 cm
-	-	According to model	Yes	-	-
Textile buckle with retro-reflective thread	-	Textile buckle		Textile buckle with retro-reflective thread	
According to model	Included	According to model	Included	Included	Included
Hook and loop fastener		QBZ® zip		Hook and loop fastener	
Extra flexible polyester	Flexible polyester, green camouflage	High-strength flexible polyester		Flexible polyester	Extra flexible polyester
-	-	-	-	-	-
-	-	✓	✓	-	-
-	-	-	-	-	-
-	-	Option	Option	-	-
- Extra soft, technical fabric - Compact and lightweight design		- High-strength fabric - High buoyancy volume - Strap for accessories (beacons, flashlights)	- High-strength fabric - Very high buoyancy volume - Strap for accessories (beacons, flashlights)	- Short teardrop cut - Pull-over design - Comfort patch on the front	- Extra soft, technical fabric - Compact and lightweight - Strap for accessories (beacon, flashlight)
	- Lonako SL3 ref. 2263071 / ref. 2263075 - Daniamant W3 ref. 60833				- Lonako SL3 ref. 2263071 / ref. 2263075 - Daniamant W3 ref. 60833
- MOB 1 (ref. 67778) - MOB2 (ref. P205314) - PLB3 (ref. 71155)		- MOB 1 (ref. 67778) - MOB2 (ref. P205314) - PLB3 (ref. 71155) - M100	- MOB 1 (ref. 67778) - MOB2 (ref. P205314) - PLB3 (ref. 71155) - M100 - M200		- MOB 1 (ref. 67778) - MOB2 (ref. P205314)
760	760	1 020	1 120	770	630
Multi-activity, standard use	Recreational fishing, sea or inshore waters	Intensive and offshore boating. Professional and industrial applications. Heavy wearers or wearers of heavy clothing		Multi-activity, frequent use	Multi-activity, standard use

WATER ON BOARD

MOORING

NAVIGATION

COMFORT

ELECTRICITY

CHANDLERY

ENGINE ENVIRONMENT

INFLATABLE LIFEJACKET SLR 196

INNOVATION BY **PLASTIMO**



A concentrate of features imagined by the sailing elite and designed thanks to the expertise of the Plastimo R&D team. Exclusive design coupled with a choice of high-tech materials make this vest a "must have" in its category. Category 150 approved, true buoyancy: 196 N.

Controlled design

- Exclusive dual-chamber technology.
- Optimized bladder design with ergonomically enhanced collar.
- Release handle integrated into vest.
- Modern design with high-tech materials and Carbon-effect fabric.

Safety and performance

- 196 N buoyancy for improved rollover efficiency and freeboard.
- Quick purge on the bladder to adjust pressure and deflate vest if needed.
- Pocket for easy access to inflation system.
- High-strength harness with textile buckle.

Lightweight and ergonomic

- Ultra-flexible, fits perfectly on the shoulders for greater ease in maneuvering.
- Intuitive to put on and adjust (belt with invisible webbing and 6 presettings).
- Quick & lightweight aluminum buckle closure.
- Neoprene collar.

EXCLUSIVE Plastimo TECHNOLOGY: Design and conception based on a structural cover and inside bladder made with polyurethane film. Technology mastered and proven for over 40 years on Plastimo liferafts.



© Guillaume Gatefait

François Gabart provided his expertise to the design of the SLR 196 lifejacket by testing it in real-life conditions alongside Tom Laperche aboard the Ultim SVR Lazartigue

Article number	Harness	Release mechanism	Model	Color
70453	with	Automatic Pro Sensor Elite	Optional sprayhood	Carbon black
70454	with	Hydrostatic HAMMAR	Optional sprayhood	Carbon black
71026	with	Hydrostatic HAMMAR	With sprayhood	Carbon black

Options and spare parts



Safety sprayhood 64950
Protects the face and airways of the man overboard.



Flashlight auto 2263071



Double blade safety knife 65475



Crutch strap 70940

Re-arming kit
For auto Pro Sensor system : 65872
(Water-dissolving cartridge only : 64496)
For Hammar system : 71038
(Inflator head only : 71037)



GOOD TO KNOW

Find all accessories for inflatable lifejackets on pages 32 / 33.

GOOD TO KNOW

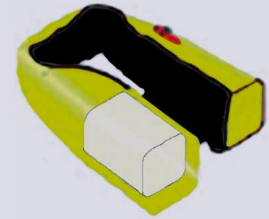

Design and construction based on a structural cover and a polyurethane film chamber. Exclusive technology mastered and proven for over 40 years on Plastimo liferafts.



Padded '3D fit' back panel with mesh: comfort and breathability

High-strength harness with textile buckle

Neoprene collar

Access pocket for the percussion system

Coated fabric reinforcement

Molle® attachment system for securing accessories

Adjustable, double and removable crutch strap



Quick release valve to adjust pressure and deflate the jacket

Strap for accessories

High-visibility fabric with retro-reflective strips

Chamber attached to the cover

Rescue handle



• Quick-release 'Stab-Lock' aluminium buckle



• Quick-fit belt with strap integrated into the vest, 6 pre-settings for quick adjustment
• Carbon-effect fabric reinforcement

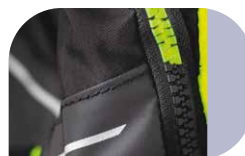

• Soft cover with QBZ® zip (Quick Burst Zip by YKK)



• Quick-release handle, ergonomic and integrated into the lifejacket



• Optimised bladder design with reinforced ergonomic neck: ensures optimum support for the head above water



PILOT 165 INFLATABLE LIFEJACKET



Always closer to your expectations, and always at a reasonable price, the iconic Pilot 165 lifejacket confirms its reputation as the universal lifejacket: now even lighter and more comfortable, it is ideal for all boating activities (coastal sailing, regular outings, cruising, racing...). And because the most effective lifejacket is the one you actually enjoy wearing, we have redesigned the outer cover to enhance comfort and bring elegance and modernity, while still ensuring the essentials: full protection of the lifejacket's functional components.

- Flexible and close to the body to accompany every movement.
- Reduced and optimized cut without being compacted to retain more flexibility.

Firing system fitted with the Cylinder Safe Retainer (CSR).
Certified in category 150N, actual buoyancy 165N.

Zippered cover with double opening :

- Lightweight, flexible fabric.
- Perfect finish, controlled opening of the cover.
- Provides better protection for the inner tube and prevents unexpected opening of the cover.
- Easier repacking during maintenance operations.
- Allows you to quickly check the condition of the head.

On lifejackets with harness : Ergonomic harness with textile buckle: more ergonomic horizontal position. High-resistance fiber with retro-reflective insert. Lightweight buckle stiff enough to easily hit the carabiner (lanyard optional).

On lifejackets without harness : Double safety buckle: double push-button, quicker to operate.

Version XXL : Automatic lifejacket with harness, equivalent to model ref. 66801 but with a belt designed for waist sizes from 60 to 175 cm

Certified compatible with:

- Ocean Signal MOB1, MOB2 and PLB3 beacons
- Lonako SL3 and Daniamant W3 flash lamps



Harness	Crutch strap	Release mechanism	Size	Color		
				Red	Black	Blue
without	without	Manual	One size	66781	66785	66783
		Automatic UML	One size	66795	66799	66797
		Hydrostatic HAMMAR	One size	66807	66811	66809
with	with	Manual	One size	-	66788	-
		Automatic UML	One size	66796	66800	-
with	without	Manual	One size	66789	66793	66791
		Automatic UML	One size	66801	66805	66803
			XXL	68786	-	-
		Hydrostatic HAMMAR	One size	66813	66817	66815
	with	Automatic UML	One size	66802	66806	-



GOOD TO KNOW

Would you like to personalize our lifejackets with your brand and logo?
Get in touch and we'll make it happen for you!



GOOD TO KNOW

Find all accessories for inflatable lifejackets on pages 32 / 33.



EVO 165 INFLATABLE LIFEJACKET

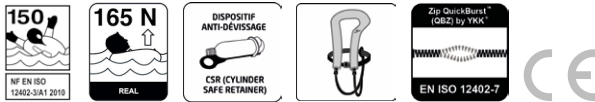

Lifejacket with a unique design: a "teardrop" like shape that frees the shoulders for greater freedom of movement. Its design has been optimized to provide great flexibility and comfort. Available in different versions for the whole family.

- **Short cut & ergonomic.**
- Flat & close to the body to facilitate upper-body movements.
- Shaped for a very active sailing (allows, for example, a wide range of motion at the helm).
- Comfortable to wear also in sitting position (kayak, fishing...).
- Ventral comfort patch, integrated into the waistband of the lifejacket.
- Black color.

Easy to put on: it slips on through the head.

Zippered cover:

- Perfect finish and better protection for the inner bladder.
- Controlled opening of the cover, quick and easy access to lifejacket components.

Removable and adjustable double crutch strap.

Models with integrated harness:

- Harness buckle in high-strength fabric.
- Lightweight fiber, with retroreflective insert.

Ref.	Release mechanism	Harness
66945	Manual	without
66955	Automatic Pro Sensor Elite	without
66961	Automatic Pro Sensor Elite	with



EVO-J JUNIOR INFLATABLE LIFEJACKET

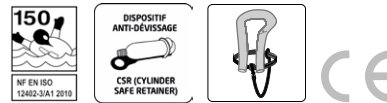

- Automatic lifejacket for children from 20 to 50 kg.
- Soft, lightweight fabric.
- 110 N buoyancy greater than the minimum 90 N required by regulations: increases freeboard and rollover performance.
- Neoprene collar for greater comfort.
- Adjustable backbone for a perfect fit.
- Integrated harness (ISO 12401) with high-strength fiber textile buckle to attach the harness.
- Firing mechanism fitted with a Cylinder Safe Retainer system (CSR)

Ref.	Harness	Release mechanism	Model
67360	with	Automatic UML	Red

NEW PLASTIMO

NEO-J INFLATABLE LIFEJACKET

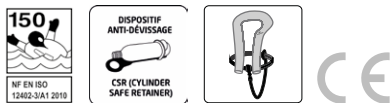

Lightweight, ergonomic lifejacket designed for children from 15 to 40 kg.

- UML automatic firing mechanism
- Firing mechanism fitted with a Cylinder Safe Retainer system (CSR)
- Equipped with textile buckle harness and crutch strap.
- Soft, lightweight fabric.
- Adjustable belt from 30 to 90 cm.
- Closing buckle in 316L stainless steel.
- ISO 12402-3 certified, buoyancy category 150 N.

Certified compatible with:

- AIS MOB1 and MOB2 Ocean Signal beacons.
- Lonaco SL3 and Daniamant W3 flash lamps.

Ref.	Color
P206049	Red
P206050	Navy blue



GOOD TO KNOW

Find all accessories for inflatable lifejackets on pages 32 / 33.



NEO 165 INFLATABLE LIFEJACKET

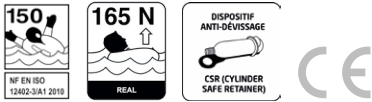

Lifejacket designed to provide comfort and safety. It combines lightness and compact size to save space. It is suitable for pleasure boating or professional use.

- 165 N of buoyancy.
- Cover with hook-and-loop fastener.
- Coated fabric polyamide.
- High-visibility bladder (fluorescent).

- Firing head fitted with Cyclinder Safe Retainer (CSR)
 - Available in version with or without harness (harness loop textile).
 - Ref. P200678 : color red black border / Ref. P200379 : color red gray border.
- Certified compatible with:
- Ocean Signal MOB1, MOB2 and PLB3 beacons.
 - Lonako SL3 and Daniamant W3 flash lamps.

Harness	Crutch strap	Release mechanism	Color			
			Red	Navy blue	Black	Olive
without	without	Manual	P202424	P200650	-	-
		Automatic UML	P200651	-	-	-
without	with	Manual	P200373	P200374	P200372	P200381
		Automatic UML	P200376	P200377	P200375	P200382
with	with	Automatic UML	P200678/P200379	70044	P200378	-
		Hydrostatic HAMMAR	-	P200559	-	-

NEW PLASTIMO

NEO 165 FISHERMAN INFLATABLE LIFEJACKET

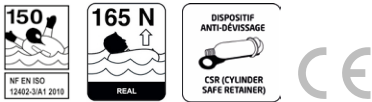

For recreational anglers or fish farming professionals looking for a lightweight, comfortable safety product.

- Lifejacket category 150 N, real buoyancy 165 N.
 - Camouflage coated outer cover
 - High-visibility inner bladder (fluorescent) with retro-reflective bands.
- Recommended use: sea, river or lake fishing, on foot or by boat, fish farming professions.
Available with manual or automatic release system. Certified compatible with:
- Ocean Signal MOB1, MOB2 and PLB3 beacons.
 - Lonako SL3 and Daniamant W3 flash lamps.



Ref.	Release mechanism
P205980	Manual
P205981	Automatic UML

GOOD TO KNOW

Would you like to personalize our lifejackets with your brand and logo?
Get in touch and we'll make it happen for you!

GOOD TO KNOW

Find all accessories for inflatable lifejackets on pages 32 / 33.

NEW PLASTIMO



PILOT 180 INFLATABLE LIFEJACKET

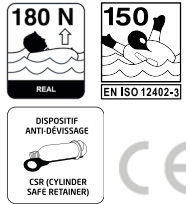

The Pilot 180 lifejacket is designed for both recreational boating and professional activities.

With a buoyancy rating of 180 N, it features a durable protective cover made from 300-denier polyamide fabric. This cover provides effective protection against wear and tear during activities such as recreational sport fishing or professional fishing, as well as for industrial applications.

The Pilot 180 lifejacket is ISO 12402-3 certified, guaranteeing its safety and reliability.

- The buoyancy has been increased to 180N to improve rollover efficiency and freeboard for wearers of heavy clothing.
- Ergonomic black collar in polyester fabric with polyurethane coating for improved flexibility.

- Closing buckle in fiberglass/polyamide (without harness) or 316L stainless steel (with harness).
 - Textile soft loop for deck harness (for harness equipped versions).
 - Inner bladder in fluorescent yellow SOLAS-certified fabric, coated with polyurethane.
 - 300-denier nylon fabric for the cover, UV-treated.
 - Manual inflation string located at the bottom of the vest, positioned close to the body to prevent accidental snagging.
 - Optional sprayhood ref 64950
- Certified compatible with:
- Ocean Signal beacons MOB1, MOB2, PLB3 and M100.
 - Lonako SL3 and Daniamant W3 flashlamps.

Harness	Crutch strap	Release mechanism	Number of burners	Color	
				Navy blue	Red
without	without	Manual	Without flash light	P200925	P200931
		Automatic Pro Sensor Elite	Without flash light	P200490	P200933
with	with	Automatic Pro Sensor Elite	With flash light	P200491	P200934

PILOT 300 INFLATABLE LIFEJACKET

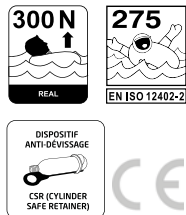

GOOD TO KNOW

Find all accessories for inflatable lifejackets on pages 32 / 33.

The Pilot 300 lifejacket is designed for both recreational boating and professional activities. With a buoyancy rating of 300 N, it is designed for deep-sea sailing, corpulent wearers or wearers equipped with heavy clothing.

It features a durable protective cover in 300 denier polyamide fabric. This cover provides effective protection against wear and tear during activities such as recreational sport fishing or professional fishing, as well as for industrial applications. The Pilot 300 lifejacket is ISO 12402-2 certified, guaranteeing its safety and reliability.

- 300N buoyancy improves rollover efficiency and freeboard, particularly beneficial for users wearing heavy clothing.
- Ergonomic black collar in polyester fabric with polyurethane coating for improved flexibility.
- Closing buckle available in fiberglass/polyamide (without harness) or 316L stainless steel (with harness).

- Textile soft loop for deck harness (for harness equipped versions).
 - XXL belt, from 55 to 175 cm. Quick-adjustment system, except P206595.
 - High-strength textile harness buckle (for model with harness).
 - Fluorescent yellow SOLAS-certified fabric bladder, coated with polyurethane.
 - 300-denier nylon fabric for cover, UV-treated.
 - Manual inflation string located at the bottom of the vest, positioned close to the body to prevent accidental snagging.
 - Firing pin viewing window.
 - Servicing date viewing window, except P206595.
 - Optional: sprayhood ref. 64950.
- Certified compatible with:
- Ocean Signal beacons MOB1, MOB2, PLB3, M100 and M200.
 - Flash lamps Lonako SL3 and Daniamant W3.

Ref.	Color	Release mechanism	Harness	Crutch strap
P206595	Red	Automatic Pro Sensor Elite	without	with
P204464	Navy blue	Automatic Pro Sensor Elite	with	with
P204465	Red	Hydrostatic HAMMAR	without	with



INFLATABLE LIFEJACKET SEAPACK 150

Ref. 67327



- Vest with manual release.
- Buoyancy chamber protected by a watertight vacuum bag, with quick tear-open.
- Ensures rollover.
- Features exceed standard requirements: buoyancy increased to 165 N and retrieval handle.
- Suitable for all navigation categories.
- May be used on passenger vessels (in accordance with applicable regulations).
- After use, the vest can be repackaged in a resealable spare bag (after cylinder replacement).
- Designed for use in an emergency situation (evacuation).
- Very compact: ideal size for a survival or weapons bag: 310 x 220 x 45 mm / Weight: 610 g (packaged with vest).
- Yellow polyurethane. Strap for attaching a safety lamp.
- Mouth inflation nozzle, whistle, 300 cm² of retro-reflective strips.
- Belt: glass-filled polyamide buckle + 40 mm wide webbing, adjustable (waist circumference 60 to 130 cm).

PLASTIMO



PILOT POCKET INFLATABLE LIFEJACKET

Ref. 65850

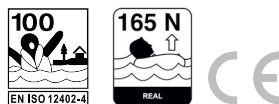

High performance

Rated 100 N category with 165 N actual buoyancy.

Keeps head and airways above water and turns wearer in the upright position.

With 165 N actual buoyancy and the addition of a grab handle, performance features are superior to the standard requirements.

Comfortable

- Lightweight and compact, leaves the wearer's upper body totally free.
- Ergonomic shape to really hug the wearer's body.
- Neoprene on inner side for added softness and comfort : feels smooth and comfy when worn next to the skin.

Easy to operate

- Manual firing : jacket will not inflate if it is heavily splashed (waves) or dropped repeatedly in the water when wearer is in learning mode.
- In case of emergency, pull the handle to unfold the air chamber and then slip over your head and pull the cord to inflate.
- Can also be inflated directly (without pulling it out of bum bag first) and then pulled over your head once inflated.

Practical and roomy

- Flat zipped pocket on the front to stash your essentials (keys etc...).
- Removable triangular pouch for additional stowage space.

RESCUE BELT INFLATABLE SAFETY BUOY

Ref. 67140



- Designed in a highly resistant material, it has two handles that enable one or two people to hold on easily.
- The buoy is attached to the fanny pack by a 1 m strap: once triggered, this buoyancy aid can be transmitted to a nearby person in difficulty to tow them to the beach.
- This buoyancy aid has been developed in partnership with water-walkers.
- Flottability 150 N.
- Mandatory for people supervising hiking in the sea groups



HOW TO CHOOSE YOUR INFLATABLE LIFEJACKET?



	NEO PRO 165	PRO 165	PILOT PRO 180	PILOT PRO 300	SOLAS 150 N	SOLAS 180N	SOLAS 275N
SOLAS approval	-	-	-	-	✓	✓	✓
Actual buoyancy	165 N	165 N	180 N	300 N	170 N	180 N	300 N
Performance level (standard)	EN ISO 12402-3	EN ISO 12402-3	EN ISO 12402-3	EN ISO 12402-2	-	-	-
Inflation (CO ₂ cylinder)	33 g	33 g	38 g	60 g	2 x 33 g	2 x 33 g	2 x 60 g
Triggering	UML MK5 automatic water-soluble cartridge	-	-	-	✓	✓	✓
	UML Elite automatic water-soluble cartridge	-	✓	✓	-	-	-
	Hammar automatic hydrostatic	✓	✓	-	✓	-	-
Lifejacket's closure	316L stainless steel or polyamide and fibreglass buckle	Stainless steel buckle	316L stainless steel buckle	316L stainless steel buckle	316L stainless steel buckle	316L stainless steel buckle	316L stainless steel or polyamide and fibreglass buckle
Waist size	55 - 140 cm	55 - 175 cm	55 - 175 cm	55 - 175 cm	55 - 175 cm	55 - 175 cm	55 - 175 cm
Quick-adjust belt	-	-	Standard on models with harnesses	On yellow models	According to model	✓	According to model
Integrated harness (EN ISO 12401)	According to model Textile buckle with retro-reflective thread	316 L stainless steel buckle	According to model 316 L stainless steel buckle	According to model 316 L stainless steel buckle	316 L stainless steel buckle	316 L stainless steel buckle	According to model 316 L stainless steel buckle
Crutch Strap	- Standard on model with harness - Optional on model without harness, ref. 50524	Single, optional, ref. 50524	- Standard double on model with harness - Single, optional on model without harness, ref. 50524	Standard, single on models without harness and double on yellow models	Simple, standard	Double, standard	Simple, standard
	Closure	Hook-and-loop fastener	Zip	Compact QBZ® Zip	Compact QBZ® Zip	Hook-and-loop fastener	Double QBZ® Zip
Outer cover	Main fabric	High-strength PVC-coated fabric, fireproof	Resistant and durable PVC, easy to clean, or fire-resistant Cordura	Resistant and durable PVC, easy to clean	High-strength polyamide or fire-resistant Panotex	High-strength polyamide coated with PVC on one or both sides, depending on model	High-strength polyamide coated with PVC on one or both sides, depending on model
	Retro-reflective element	-	✓	✓	✓	-	✓
	Viewing window	-	-	✓	✓	-	-
Fire resistance	-	✓	✓ (black model)	-	✓ (Panotex model)	-	-
Sprayhood (EN ISO 12402-8)	-	Optional, ref. 64950	Optional, ref. 64950	Optional, ref. 64950	Standard on Panotex fire-resistant model	- Optional, ref. 64950, on 64290 et 64291, - Standard on ref. 65336	Standard on models with harness
Key features	- Lightweight and compact - Durable and easy-to-clean cover	- Lightweight and compact - Fire-resistant cover that is easy to maintain	- Ergonomic black collar made of polyurethane-coated polyester fabric - High buoyancy volume	- Ergonomic black collar made of polyurethane-coated polyester fabric - Very high buoyancy volume - Molle® attachment strap	- Ergonomic and protective double chamber bladder - Fire-resistant version	- Asymmetrical double chamber bladder - High-resistance, washable model	- Ergonomic and protective double chamber bladder - Very high buoyancy volume
Compatible flashlights	- Lonako SL3 ref. 2263071 and 2263075 - Daniamant W3 ref. 60833	- Integrated Lonako SL3 ref. 2263071 - Daniamant W3 ref. 60833	- Lonako SL3 ref. 2263071 and 2263075 - Daniamant W3 ref. 60833	- Lonako SL3 ref. 2263071 and 2263075 - Daniamant W3 ref. 60833	Aquaspec AQ8A	Integrated Daniamant W3	Aquaspec AQ8A
Compatible beacons	Ocean Signal MOB1, MOB2 and PLB3	Ocean Signal MOB1, MOB2 and PLB3	Ocean Signal MOB1, MOB2, PLB3 and M100	Ocean Signal MOB1, MOB2, PLB3, M100 and M200	Ocean Signal MOB1, MOB2, PLB3 and M200	-	Ocean Signal MOB1, MOB2, PLB3 and M200
Lifejacket weight (from ..kg / ex. manual model without harness)	0,800 Kg	0,900 Kg	0,950 Kg	1,200 Kg	1,750 Kg	1,580 kg (ref. 64290) 1,665 kg (ref. 65336)	2,200 Kg
Recommended use	Recreational or professional use, standard use	Recreational or professional use, frequent use	Recreational, sport or commercial fishing, industrial applications	Intensive and offshore navigation. Professional and industrial applications. Heavy-set wearers or those wearing heavy clothing.	Professional use: fishing, oil rigs, wind farms, welding (Panotex)	Professional use: fishing, oil rigs, wind farms	Professional use: fishing, oil rigs, wind farms. Heavy-set wearers or those wearing heavy clothing

NEW PLASTIMO



NEO PRO 165 INFLATABLE LIFEJACKET

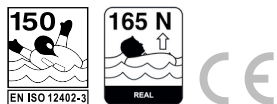

Designed to provide both comfort and safety, this lifejacket combines lightweight construction with a compact design for space saving. Suitable for both leisure boating and professional use.

- True buoyancy 165N.
- Cover with hook-and-loop closure.
- Heavy duty PVC-coated fabric cover, very easy to clean and maintain.
- High-visibility fluorescent bladder.
- Hammar Hydrostatic inflation System.
- Available in yellow with harness and crutch strap (textile harness buckle) or orange without harness, without crutch strap.

Certified compatible with:

- Ocean Signal MOB1, MOB2 and PLB3 beacons.
- Lonako SL3 and Daniamant W3 flash lamps.



Ref.	Color	Harness	Crutch strap
P200561	Orange	without	without
P200560	Yellow	with	with



PILOT PRO 180 INFLATABLE LIFEJACKET



The Pilot Pro 180 is designed for both recreational boating and professional activities.

With a buoyancy rating of 180 N, it is offered in 2 versions of durable protective cover:

- in orange or yellow PVC double-coated fabric.
- in black fireproof cordura fabric.

Those covers provides effective protection against wear and tear during activities such as recreational sport fishing or professional fishing, as well as for industrial applications.

The Pilot Pro 180 lifejacket is ISO 12402-3 certified, guaranteeing its safety and reliability.

An innovative lifejacket:

- Buoyancy has been increased to 180N to improve rollover efficiency and freeboard for heavy clothing wearers.
- Ergonomic black collar in polyester fabric with polyurethane coating

for improved flexibility.

- Closing buckle in 316L stainless steel.
 - Bladder made with SOLAS-certified fluorescent yellow fabric, coated with polyurethane.
 - Manual inflation string located at the bottom of the vest, positioned close to the body to prevent accidental snagging.
 - Firing mechanism fitted with Cylinder Safe Retainer (CSR).
 - Double-opening zip, allows quick check of head condition and facilitates maintenance operations.
 - Flame-retardant fabric (EN 15025 compliant), slows fire spread, on vest ref. P200916.
 - Optional sprayhood mask ref. 64950.
- Certified compatible with:
- Ocean Signal beacons MOB1, MOB2, PLB3 and M100.
 - Lonako SL3 and Daniamant W3 flash lamps.

Release mechanism	Harness	Crutch strap	Color		
			Yellow	Orange	Black
Automatic Pro Sensor Elite	without	without	P200478	P200482	-
	with	with	P200479	P200483	P200916

NEW PLASTIMO



GOOD TO KNOW

Find all accessories for inflatable lifejackets on pages 32 / 33.

PRO 165 INFLATABLE LIFEJACKET AUTO HAMMAR WITH HARNESS AND FLASHLIGHT

Ref. P205768

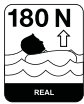

The Plastimo Pro 165 lifejacket is designed for professional activities.

- With a buoyancy rating of 165 N, it features a heavy duty, washable protective cover.
- The firing system is hydrostatic (Hammar MA1) and prevents untimely triggering even in the event of heavy water splashes.
- The fabric of the cover and collar are fire-resistant (M2). The cover will effectively protect against dirt and wear during activities such as fishing, sport or commercial or for tough industrial applications.



- Stainless steel buckle closure and harness with stainless steel "D" buckle.
 - The cover is equipped with Solas retroreflective stripes.
 - SOLAS approved flashlight included.
 - The PRO 165 lifejacket is ISO 12402-3 certified.
- Certified compatible with:
- Ocean Signal MOB1, MOB2 and PLB3 beacons.
 - Lonako SL3 and Daniamant W3 flashlights.



PILOT PRO 300 INFLATABLE LIFEJACKET

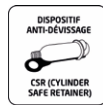

The Pilot Pro 300 is designed for both recreational boating and professional activities. With 300N buoyancy, it features a durable protective fabric cover with ultra-resistant double PVC coating featuring anti-UV and anti-mould treatment. The cover provides protection against wear and tear in activities such as recreational sport fishing or professional fishing, as well as for industrial applications. It features SOLAS retroreflective strips with MOLLE system for attaching accessories such as a VHF radio. The Pilot Pro 300 lifejacket is certified 275N EN ISO 12402-2.

An innovative lifejacket:

- Buoyancy increased to 300 N to improve rollover efficiency and freeboard, ideal when wearing heavy equipment and clothing.
- Ergonomic black collar in polyester fabric with polyurethane coating for improved flexibility.



- 316L stainless steel buckle.
 - XXL belt, adjustable from 55 to 175 cm, with quick-adjust system (except orange model, ref. P204496).
 - 316L stainless steel harness D-ring.
 - High-visibility SOLAS-certified fluorescent yellow bladder, polyurethane-coated.
 - Double PVC-coated fabric cover.
 - Manual inflation pull tab located at the bottom of the jacket, positioned close to the body to prevent accidental snagging.
 - Viewing window for inflation system status.
 - Optional: anti-brass mask ref. 64950.
- Certified compatible with:
- Ocean Signal beacons MOB1, MOB2, PLB3, M100 and M200.
 - Lonako SL3 and Daniamant W3 flash lamps.

Ref.	Color	Release mechanism	Harness	Crutch strap
P204496	Orange	Automatic Pro Sensor Elite	without	with
P204497	Yellow	Automatic Pro Sensor Elite	with	with
P204498	Yellow	Hydrostatic HAMMAR	without	with

 GOOD TO KNOW

SOLAS lifejackets are designed for professional use on commercial vessels, fishing boats, wind, oil and offshore platforms... They offer an optimal level of technicality to enable professionals to carry out their activity in complete safety. All SOLAS-certified lifejackets feature a double-chamber bladder ensuring a very high level of safety, perfectly adapted to the conditions of use of this type of lifejacket.

- 2 firing mechanisms
- 2 overpressure valves
- 2 mouthpieces for buccal inflation



 GOOD TO KNOW

Find all accessories for inflatable lifejackets on pages 32 / 33.

AUSTRAL 180N INFLATABLE LIFEJACKET SOLAS

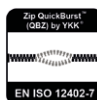

SOLAS vests are designed for professional use: merchant ships, fishing vessels, wind, oil or offshore platforms... They offer an optimal level of technicality to enable professionals to carry out their activity in complete safety.

One size: from 43 kg. Waist circumference: 55-175 cm.

Unrivalled performance

- Actual buoyancy increased to 180N.
- Dual chamber with 2 independent inflation systems.
- Inflation system fitted with a Cylinder Safe Retainer (CSR).
- Manual and automatic release.
- Asymmetrical air chamber with articulated collar to optimize freeboard and rollover while providing head-out-of-water support.

Controlled design & durable materials

- Tough, flexible technical fabrics.
 - Outer cover closed by a YKK QBZ® (Quickburst) zip, for better inner tube protection, prevents unexpected cover openings.
 - Zip with 2 opening points for faster inflation.
- Maximum equipment level
- Integrated harness.
 - Double crutch strap.
 - Integrated SOLAS flashlight.
 - Pocket with safety line.
 - Strap for emergency beacon and accessories.
 - Belt with quick-adjust buckle.

Ref.	Release mechanism	Harness	Crutch strap	Color	Sprayhood
64290	Automatic UML	with	with	Red	Cover with retro-reflecting strips.
64291	Automatic UML	with	with	Orange	Cover with retro-reflecting strips. High resistance, washable (coating on both sides).
65336	Automatic UML	with	with	Orange	Cover with retro-reflecting strips. High resistance, washable (coating on both sides). Sprayhood.

NEW PLASTIMO



SOLAS 150 INFLATABLE LIFEJACKET PANOTEX FIRE-PROOF COVER WITH HARNESS AND CRUTCH STRAP

Ref. P206525

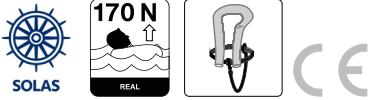

SOLAS lifejacket with fire-retardant cover for professional use: suitable for commercial vessels, fishing boats, oil platforms, wind farms, and offshore operations.

- Fireproof cover in aluminized Panotex® fabric, hook-and-loop closure.
 - Double chamber with 2 independent automatic UML inflation systems.
 - Firing system fitted with Cylinder Safe Retainer(CSR).
 - Bladder with optimized design to improve rollover and freeboard performance.
 - Stainless steel buckle with quick-adjust waist belt, from 55 to 175 cm.
 - Crutch strap.
 - Lifting loop, whistle, retro-reflective tapes.
 - One size, from 43 kg upwards.
- Certified compatible with:
- Ocean Signal MOB1, MOB2, PLB3 and M200 beacons.
 - Aquaspec AQ8 flash lights.



WATER ON BOARD

MOORING

SOLAS 150 INFLATABLE LIFEJACKET RED UML WITH HARNESS AND CRUTCH STRAP

Ref. P206526



SOLAS 150 N lifejacket for professional use with harness and crutch strap

- Red polyamide cover, hook-and-loop closure.
 - Twin chamber with 2 independent UML automatic inflation systems.
 - Firing system fitted with Cylinder Safe Retainer(CSR).
 - Optimised bladder design for enhanced freeboard and fast turn-over performance.
 - Stainless steel buckle with quick-adjust waist belt, from 55 to 175 cm.
 - Crutch strap.
 - Lifting loop, whistle, retro-reflective tapes.
 - One size, from 43 kg upwards.
- Certified compatible with:
- Ocean Signal MOB1, MOB2, PLB3 and M200 beacons.
 - Aquaspec AQ8 flashing lights.



NAVIGATION

COMFORT

SOLAS 275 INFLATABLE LIFEJACKET

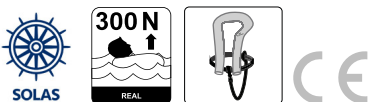

Inflatable lifejacket with dual inflation system and twin air chambers, offering high buoyancy.

Designed for professional use: fishing vessels, commercial ships, oil platforms, wind farms...

The SOLAS-approved 275 N lifejacket is designed for use both as a working lifejacket and as an emergency evacuation lifejacket.

Incredibly light and comfortable, it provides excellent support to the neck and head – a critical feature for unconscious casualties.

With an actual buoyancy of 300 N, this lifejacket is suitable for wearing over heavy clothing or survival suits.

- For users > 43 kg
- Adjustable waist belt from 55 to 175 cm
- Waist buckle in fiberglass/polyamide (without harness) or stainless steel 316L (with harness)
- Stainless steel 316L harness D-ring (harness versions)
- Actual buoyancy: 300 N, twin chamber
- 2 x UML MK5 inflators
- Retro-reflective tape on bladder
- Integrated lifting loop

GOOD TO KNOW

Find all accessories for inflatable lifejackets on pages 32 / 33.

- 2 cover versions: polyamide or heavy-duty PVC
- Sprayhood on harness versions
- Supplied with Aquaspec AQ8A flashing light
- Compatible with survival suits
- Compatible with Ocean Signal beacons: MOB1, MOB2, PLB3, M200



ELECTRICITY

CHANDLERY

ENGINE ENVIRONMENT

Ref.	Material	Color	Harness	Crutch strap
P206593	Polyamide	Red	without	with
P206150	Polyamide	Red	with	with
P206149	PVC	Orange	with	with



SAFETY SPRAYHOOD

Ref. 64950



- Easily fits over a Plastimo inflatable lifejacket.
- Protects the face and airways of the man overboard.
- Increases chances of survival.
- Y-shape so as not to obscure accessories whose function is to transmit (beacon, flashlight...) or facilitate location (reflective strip).
- Optimum visibility: fluorescent orange color and reflective stripes on head and chest.
- Required by many racing regulations.
- Certified to fit vests: Pilot 165, EVO 165, SL180, Pilot Pro 180, Pilot 275, Pilot 290, Pilot Race, Austral SOLAS.

SELECTED BY **PLASTIMO**

WHISTLE

Ref. 52937



- Polypropylene whistle.
- Required on all lifejackets from 100 N.
- ISO 12402-8.
- Dimensions: 7.3 x 1.9 x 2 cm (L x H x W).
- Weight: 5 g.
- Sound power: 100 dB at 5 m.

SELECTED BY **PLASTIMO**



SIGNALING MIRROR RED DOT

Ref. 27177

- Only this type of mirror equipped with a viewfinder allows the luminous glow to be directed towards the rescue.



CRUTCH STRAP FOR INFLATABLE LIFEJACKET

- Highly recommended: prevents the vest from riding up and facilitates swimming.
- Polyester webbing with plastic buckles.

Ref.	Type	Model
50524	Single	For Pilot 165, Neo 165, Pilot 180, Pilot 275
65997	Double	For SL 180, Pilot 290, Austral



POUCH WITH MOLLE® ATTACHMENT SYSTEM FOR LIFEJACKET

- Available in 4 models.

Ref.	Model
63565	Small size: 4 x 4 inches
63566	Medium size, vertical format: 4 x 7.5 inches
63567	Medium size, landscape format: 6.7 x 4 inches
63568	Large size: 6.7 x 7.5 inches



DOUBLE BLADE SAFETY KNIFE

Ref. 65475

- Stainless steel rope-cutting blade, non-slip plastic handle.
- Ergonomically designed for excellent grip in emergency situations.
- Safety blade rounded inside, sharp inside.
- Length: 13.5 cm.
- Delivered with holster (for belt or vest waist strap).

SELECTED BY PLASTIMO

MANUAL FLASHLIGHT



SOLAS

- Individual LED lights for lifejackets, vests or wetsuits.
- Recommended for activities with the possibility of immersion or frequent contact with water (jet-skiing, windsurfing, paddling, kayaking, kitesurfing).
- Expiry date 5 years.
- Compact model.
- Recyclable alkaline battery.
- Shatter: 51 to 54/minute.
- Weight: 37 g including clip.



Ref.	Model
2263075	Unit
2263076	20 pack

SELECTED BY PLASTIMO

AUTOMATIC FLASHLIGHT



SOLAS

- Individual LED lights for lifejackets, vests or wetsuits. They trigger on contact with water. They can be switched on and off manually.
- Expiry date 5 years.
- Compact model.
- Recyclable alkaline battery.
- Bursts: 51 to 54/minute.
- Weight: 37 g including clip.



Ref.	Model
2263071	Unit
2263072	20 pack
70595	Unit - with fitting for inflatable jacket's oral tube



PLASTIMO

SAFETY FLASHLIGHT YELLOW

Ref. 301733

4 LED flashlight, floating and waterproof to 100 meters. Ideal for boating, diving, jet skiing...

- 4 very bright white LEDs, lifetime: 5,000 hours.
- 50-70 flashes per minute.
- Repairable to 2 km.
- ABS case and polycarbonate optics.
- Weight: 190 g with batteries.
- Power supply: 3 AA batteries (not included).
- Delivered with safety strap and armband strap.
- Dimensions: H. 122 x Ø 52 mm.



Daniamant
Be safe at sea

W3 AUTOMATIC LED FLASHLIGHT



SOLAS

Automatic activation by sensor contact with water. Can be switched off manually. Protected by an extra-flat dome guaranteeing wide diffusion of the light signal and considerably reducing the risk of damage during rescue operations.

- Autonomy: 8 hours.
 - Flashes: 55/mn.
 - Range: 2 MN.
 - Lithium battery (5-year life).
- SOLAS / MED / USCG / Canada / Russia / South Africa approved.
For use on jet-ski, windsurf, paddle, kayak, kitesurf, etc. choose the manual model.

	Ref.	Model
A	60833	Clip
B	62058	Clip et support for inflatable jacket's oral tube
C	61941	4 mounts



CYALUME
TECHNOLOGIES

SNAPLIGHT LIGHTSTICK

100% reliable, unbreakable, non-corrosive, waterproof, non-toxic, flameless and non-flammable, non-sparking and battery-free, it can be used in all circumstances.

- 15 x 2 cm cylinder, waterproof and buoyant, with fixing eye.
- Instantly produces a bright light.
- Minimum range 1 MN.
- Phthalate-free.

	Ref.	Lighting colour	Run Time	Quantity
A	301487	Green	12 h	2
A	19668	Green	12 h	10
B	65933	Green	12 h	24
C	P202139	Yellow	12 h	10
D	65935	Red + Green + White	8 h (white) 12 h (red & green)	3

INFLATABLE LIFEJACKETS SERVICING



Checking and reviewing lifejackets

In the absence of a regulation setting a revision frequency, Plastimo recommends:

- A **regular visual inspection** carried out by the skipper, who is responsible for the safety of his crew.
- A complete revision carried out **at least every 3 years at the factory** by Plastimo or one of its **approved stations**. In the case of intensive or professional use, an annual revision is required.

Visual inspection

Before each trip out of the sea, we strongly recommend that you check your lifejacket's general condition, following the indications in the user's manual. This consists in checking the major components and making sure that none of them gives evidence of any wear and tear :

- Outer cover
- Inflatable chamber
- Straps
- Fastening buckles
- Whistle
- Retroreflective tapes
- CO₂ bottle
- Firing head

Since May 2020, Plastimo incorporate a Cylinder Safe Retainer (CSR) in the production of all their inflatable lifejackets*. Lifejackets currently in use will be upgraded to include the CSR when they are sent for servicing to the Plastimo factory or to a Plastimo approved station.



*UML inflation heads, models MK2, MK5, M2, M3 and Pro Sensor.



Pay particular attention to

FIRING HEAD

The gas bottle must be full, firmly secured/ screwed and showing no sign of corrosion. Check the correct status of the green safety indicators (green clip or green bright spot).



EXPIRY DATE

Expiry date on the firing head of automatic or hydrostatic inflation models.



Approved service station/factory servicing

A complete inspection at the factory or an approved service station involves:

- Thoroughly checking the overall condition of the lifejacket and its components.
- Inflating and checking the air chamber for leaks.
- Checking the inflation system (impact head, CO₂ cylinder).
- Upgrading the lifejacket, for example in the event of regulatory changes.
- Folding and repackaging the lifejacket according to a specific procedure.



Use-by-date / product lifetime

The lifespan of a lifejacket is a maximum of 10 years after the date of initial purchase (lifejackets certified to ISO 12402:2020). The lifespan depends directly on the quality of storage, frequency and conditions of use. Storing the lifejacket in a dry place during winter preserves all components and helps to increase the lifespan of the lifejacket. Plastimo recommends replacing lifejackets that show signs of wear and tear.



GOOD TO KNOW

For more information, contact an approved service center or the after-sales department.

Find all approved service centers at www.plastimo.com or look for them **in stores with this sticker**. These service stations are also authorised to service lifejackets for professional use and PFDs, which are subject to annual servicing by regulation.



Which refill kit for your lifejacket?
Identify the type of percussion head

	SLR 196	Neo-J Pilot Junior EVO-j	Neo 165 Neo Pro 165 Pro 165 Pilot 165 ; EVO 165 Seapack ; Seashore Pilot Pocket Rescue belt Pilot Race Quickfit ; Easyfit	Pilot 180 Pilot Pro 180 SL180	Pilot 275 IOR Dan Buoy	Pilot 290 Pilot 300 Pilot Pro 300	SOLAS 150 Austral 180	SOLAS 275		
Buoyancy	196 N	110 N	150 N - 165 N	180 N	275 N	290 N - 300 N	150 N - 180 N	275 N		
Bottle model	38 g	24 g	33 g	38 g	60 g	60 g	2 x 33 g	2 x 60 g		
COMPLETE RECHARGE KIT										
PERCUSSION SYSTEM ONLY										
Uml manual (no automatic trigger cartridge)		-				-	-	-	-	-
Automatic MK5 UML										
Pro Sensor Automatic (with indicators) UML MK2 MK3		-				-	-	-		-
Pro Sensor «Elite» Automatic (with indicators)		-				-	-	-		-
Hammar Automatic (hydrostatic) A1		-				-	-	-		-
Hammar Automatic (hydrostatic) MA1		-					-	-		
										(Pilot 290) (SLR 196)

ENGINE ENVIRONMENT

CHANDLERY

ELECTRICITY

COMFORT

NAVIGATION

MOORING

WATER ON BOARD

SAFETY



PLASTIMO



SAFETY EXPERTISE FOR PROFESSIONALS

Designed for the most extreme environments, these new lifejackets combine optimised comfort, enhanced functionality and proven reliability, making this range the reference for safety and performance at sea.



Typhoon[®]

EXPLORE WITH CONFIDENCE

HUDSON / 50 N BUOYANCY AID

Ergonomic design for flexibility & movement | Front entry YKK zip | Front chest pocket with zip | Internal whistle | Crotch strap | Fully adjustable shoulder and waist webbing straps | Quick release front clasp | Elasticated side panels | BS EN ISO 12402-5 approved



CLUB MASTER BUOYANCY AID

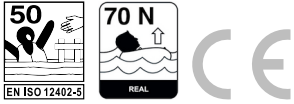

This buoyancy aid vest ensures its wearer's safety thanks to its many features:

- Highly resistant coated polyester fabric cover.
- Flotation by polyethylene foam.
- Closing and adjustments by 2 straps with buckles : waistband and chest strap.
- Belt passed through a back tunnel, to avoid any risk of snagging.
- Wide, elasticated armholes.
- Elasticated waist.
- Whistband.
- Undercut.

Straps color-coded by size.



Ref.	Size	Wearer's weight	Color
63937	XS	<30 kg	Yellow
63938	S	30-40 kg	Blue
63939	M	40-60 kg	Grey
63940	L	60-80 kg	Black
63941	XL	>80 kg	Red

LIFEJACKET KID'O



These foam lifejackets are perfectly suited to the youngest, in all situations. Certified in category 100N, they ensure rollover and keep the head out of the water.

- Polyethylene foam provides buoyancy and impact protection.
- Buoyancy exceeds standard requirements.

- Large wrap-around collar keeps the head out of the water.
- High visibility: bright colors and retroreflective stripes.
- Easy to put on: zip closure and adjustable belt with plastic buckle.
- crutch strap: prevents the vest from riding up when the child is in the water.

Wearer's weight	Color	
	Yellow	Orange
3-8 kg	71022	71018
8-15 kg	71023	71019
15-30 kg	71024	71020
30-40 kg	71025	71021

TYPHOON LIFEJACKET - 100 N

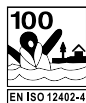

This lifejacket:

- Ensures rollover and keeps the head out of the water.
- Equipped with retro-reflective strips, whistle and crutch strap.
- Zip closure, adjustable belt with buckle closure. Drawstring at base.
- Buoyancy by polyethylene foam.
- 100% polyester fabric, fluorescent orange.

Ref.	Wearer's weight	Size
61091	40-50 kg	S
61092	50-70 kg	M
61093	70-90 kg	L
61094	+ 90 kg	XL

TYPHOON LIFEJACKET - 150 N



This lifejacket:

- Ensures rollover and keeps the head out of the water.
- Equipped with retro-reflective strips, whistle, towing handle and double adjustable crutch strap.
- Hanging tab for flashlight (W3 lamp ref. 60833 included depending on model).
- Zip closure, adjustable belt with buckle closure. Drawstring at base.
- Buoyancy by polyethylene foam.
- 100% orange polyester fabric.

In compliance with Division 240, regulatory vest in France for all boating categories.

Wearer's weight	Size	Flashlight	
		Without flash light	With flash light
40-50 kg	S	61087	61625
50-70 kg	M	61088	61626
70-90 kg	L	61089	61622
+ 90 kg	XL	61090	61627

PLASTIMO



STORM LIFEJACKET - 100 N



- Assures rollover and keeps head out of water.
- Equipped with retro-reflective strips & whistle.
- Clipping tab for flashlight (W3 lamp ref. 60833 included depending on model).
- Fastened with a round-the-waist cord.
- Buoyancy by polyethylene foam.
- 100% polyester fabric, fluorescent orange.

Wearer's weight	Size	Flashlight	
		Without flash light	With flash light
40-50 kg	S	58358	58361
50-70 kg	M	58359	58362
+ 70 kg	L	58360	58363

STORM LIFEJACKET - 150 N



This lifejacket:

- Ensures rollover and keeps the head out of the water.
- Equipped with retro-reflective strips, whistle, towing handle and adjustable double crutch strap.
- Hooking tab for lamp flash (W3 lamp ref. 60833 included depending on model).
- Fastened with a round-the-waist cord.
- Buoyancy by polyethylene foam.
- 100% orange polyester fabric.

Without flash light	With flash light	Wearer's weight	Size
58352	58355	40-50 kg	S
58353	58356	50-70 kg	M
58354	58357	+ 70 kg	L



STORM BUOYANCY AID - 50 N



- Fastening by drawstring.
- Flotation by polyethylene foam.
- Fabric 100% polyester, fluorescent orange.
- Does not roll over and has no signalling or tracking equipment.

Ref.	Wearer's weight	Size
63739	40-50 kg	S
63740	50-70 kg	M
63741	+ 70 kg	L/XL



SAFETY BAG BLACK

Ref. 62338

- PVC-coated polyester bag with reinforced rigid bottom.
- Zipper system closure.
- Composed of 2 interior mesh compartments for storage of armbands and safety equipment.
- Portage: 2 groupable hand loops with integrated handle.
- 2 hook-and-loop straps for gaff support; 1 outer PVC crystal pocket, useful for storing armament list or any other document.
- Capacity: 110 L.
- Bag sold without armament.
- Gaff and armbands sold separately.



SET OF STORM LIFEJACKETS - 100 N +70 KG



- Pack of Storm lifejackets with PVC storage bag.
- Zip-closure bag and mesh for ventilation.
- Bras size L/XL for wearer + 70 kg (ref. 58360).
- Available in pack of 4 or 6 buoyancy aids.

Ref.	Set of	Dimensions
60909	4	L 62 x l 35 x H 30 cm
60910	6	L 62 x l 35 x H 45 cm



DOG FLOTATION VEST

Flotation ensured by flexible closed-cell foam. Closing and adjustments:

- 2 straps with quick-release buckles on body.
 - Strap with buckle and hook-and-loop at neck.
- Equipped with:
- Reflective stripes.
 - Leash attachment loop.
 - Lifting handle.

The S model is also suitable for cats.

Ref.	Size	Back length	Neck size	Max. chest girth
70596	S	23 cm	max. 45 cm	45 cm
70597	M	30 cm	max. 56 cm	56 cm
70598	L	36 cm	max. 63 cm	63 cm
70599	XL	41 cm	max. 75 cm	74 cm



PLASTIMO

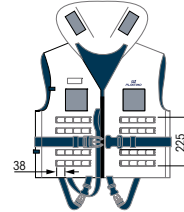
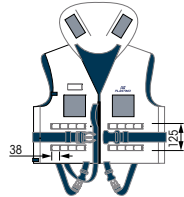

TYPHOON NAVY LIFEJACKET



Lifejacket features:

- Buoyancy 150 N by polyethylene foam.
- Highly abrasion- and tear-resistant 600 D polyester fabric cover.
- Closing: zip, adjustment belt with buckle and tightening lace.
- Adjustable double crutch strap.
- Comfort: ergonomic 3-part collar.
- Visibility: 300 cm² of retro-reflective strips.
- Towing handle.

Other accessories available on request: signaling mirror, 2 recall tips, fluorescein sachet, chemiluminescent stick...

Molle® (*)type attachment system consisting of straps sewn onto the vest cover.

- 2 Molle® straps on size S
- 4 Molle® straps on sizes M, L and XL

(*)Modular Lightweight Load-carrying Equipment

Without flash light	With flash light	Wearer's weight	Size
63557	65216	30-50 kg	S
63558	65217	50-70 kg	M
63559	65218	70-90 kg	L
63560	65219	90 + kg	XL



PLASTIMO

BOSUNS CHAIR PRO-COMFORT BLACK

Ref. 68797

No compromises for the Pro-Comfort model, which ensures safety and comfort.

Composed of two adjustable straps around the thighs for greater support and reassurance.

Optimum adjustment and fit ensured by 2 side straps that allow the back to be wedged and tilted.

Reinforced back support ensured by 2 straps that pass over the top and bottom of the back, ideal for hoisting yourself up the mast.

- 220 denier polyester fabric.
- Bucket seat.
- 40 mm wide thigh straps.
- 45 mm wide back straps.
- 2 thigh tightening adjustments.
- 2 seat tilt adjustments.
- MOLLE® system on each side.
- 1 tool bag with gusseted pocket: 52 x 21 x 8 cm. The bag attaches to the chair with 2 straps. This bag is also used to store the chair.
- Maximum working load: 150 kg.



PLASTIMO

POUCH WITH MOLLE® ATTACHMENT SYSTEM FOR LIFEJACKET

Available in 4 models.

Ref.	Model
63565	Small size: 4 x 4 inches
63566	Medium size, vertical format: 4 x 7.5 inches
63567	Medium size, landscape format: 6.7 x 3.9 inches
63568	Large size: 6.7 x 7.5 inches

SELECTED BY **PLASTIMO**

SOLAS LIFEJACKET



Buoyancy Aid designed to equip fishing and commercial boats, passenger vessels and pleasure cliferaft over 25 meters. Format optimized for minimal bulk: the lifejackets stack perfectly without wasting space.

- Certified in category 150 N.
- Flotation by polyethylene foam.
- SOLAS retro-reflective strips on chest, collar and outer edges (actual surface area almost 30% greater than regulatory requirements).
- Whistle ISO 12402-8.
- Floating safety line with hook neatly folded in bespoke pocket.
- Polypropylene webbing hauling handle.
- Waist fastening with composite plastic buckle and toggle below chin for good body fit.

Mandatory Solas flashlight : don't forget to order it separately if you choose a buoyancy aid that doesn't come with one.

The owner must ensure that the fitting complies with the regulations of the country in which the vessel is registered.

Ref.	Model	Size
P201028	15 to 43 kg	Child
P204036	> 43 kg	Adult



PLASTIMO

BOSUN'S CHAIR FIRST BLACK

Ref. 68796

This First model is the perfect answer to a need for practicality. Easy front adjustment and a semi-rigid backrest for safe and efficient climbing.

- 220 denier polyester fabric.
- Ergonomic front adjustment with all-round sliding belt.
- Rigid pocket opening.
- 1 deep pocket: 36 x 20 cm.
- 1 practical semi-deep pocket for small items: 26 x 20 cm.
- MOLLE® system on one pocket.
- Maximum working load: 100 kg.

GOOD TO KNOW

Try on your harness : a harness is personal; the straps must be adjusted to your build, and it's essential that you know how to put it on quickly. Try it on and, above all, adjust it. If the harness is worn with an inflatable vest, it should be worn underneath the vest.

Take care of your harness : the harness is a fundamental element of your safety and should therefore receive your full attention. Unlike a lifejacket, on which buoyancy can be tested and possible signs of wear can appear visibly, a harness can lose its original performance without obvious signs.

- Rinse it after use.
- Check the seams regularly.
- Never store it in a damp place.
- Systematically dispose of and replace a harness that shows signs of wear and/or has been stressed. We recommend that regular racers and sailors, whose harnesses are used intensively and are particularly exposed to UV rays, change their harnesses every year.
- Never use a harness for anything other than its intended purpose.

DECK SAFETY HARNESS DOUBLE ADJUSTMENT

Ref. 66829



Ergonomically designed, double-adjustable harness. Quick, easy adjustment.

- Minimum/maximum chest circumference: 50-130 cm.
- Belt and shoulder straps adjust simultaneously.
- X-shaped back construction guarantees excellent comfort and total freedom of movement.
- Once the harness is adjusted, the excess webbing attaches to the belt with hook-and-loop fasteners.

- Black and fluorescent bi-color for easy spotting.
 - Textile buckle lanyard attachment point can be spotted at night thanks to the retroreflective thread sewn into the buckle.
 - Harness buckle breaking load: 2,000 DaN - 2,040 kg.
 - Wide 45 mm webbing.
 - Delivered in a mesh storage bag.
- With its optimized adjustment system, this harness fits all sizes, even juniors (from 20 kg).



DECK SAFETY HARNESS SINGLE ADJUSTMENT

Ref. 66830



- Adjustable harness belt.
- Min/max chest circumference: 80-120 cm (from 50 kg).
- Textile loop lanyard attachment point can be spotted at night thanks to the retroreflective thread sewn into the loop.

- Harness buckle breaking load: 2,000 DaN - 2,040 kg.
- Wide 45 mm webbing.
- Weight 250 g.
- Delivered in a mesh storage bag.



DECK SAFETY HARNESS SIMPLE ADJUSTMENT WITH TETHER

- Textile loop tether attachment point can be spotted at night thanks to the retroreflective thread sewn into the loop.
- Min/max chest circumference: 80-120 cm (from 50 kg).
- Double-security stainless steel snap hook.

- Harness buckle breaking load: 2,000 DaN - 2,040 kg.
- Wide 45 mm harness webbing.
- Spout opening: 14.5 mm.
- Delivered in mesh storage bag.



Ref.	Model
67037	Simple adjust. harness + 1 hook tether
67038	Simple adjust. harness + 2 hooks tether

 GOOD TO KNOW

The tether is the essential complement to the inflatable vest, provided you have selected a lifejacket model "with harness", fitted with a buckle.

- Very supple polyester webbing with retroreflective thread for quick and easy nighttime spotting.
- All Plastimo tethers are equipped with self-closing carabiners to prevent untimely opening.
- Load indicator: when the tether is subjected to too great a load (e.g. during a fall), the overload indicator cuts out, revealing a label indicating that the tether needs to be replaced.
- Flat, elastic or double version with a width of 23 mm.
- Delivered in a mesh storage bag.
- ISO 12401 approved.

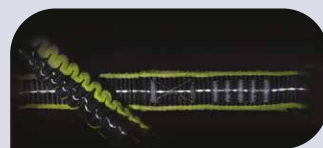

Retro-reflective filter



TETHER - STAINLESS STEEL SNAP HOOK



- Double safety.
- Bill opening: 14.5 mm.
- Weight: 145 g.

	Ref.	Number of hooks	Weight	Lanyard length	Type of lanyard
A	66834	1	215 g	1.5 m	Flat lanyard
B	66838	2	345 g	1.5 m	Flat lanyard
C	66836	1	225 g	1 - 1.5 m	Elastic lanyard
D	66840	2	355 g	26 cm	Elastic lanyard
E	66865	3	550 g	Flat lanyard 1 m + extendable lanyard 1 to 1.5 m	Double lanyard



TETHER - ALUMINIUM HOOK WITH FERULE



- Easy opening and closing with ferrule.
- Light and compact.
- Spout opening: 20 mm.
- Weight: 100 g.

	Ref.	Number of hooks	Weight	Lanyard weight	Type of lanyard
A	66833	1	175 g	1.5 m	Flat lanyard
B	66837	2	275 g	1.5 m	Flat lanyard
C	66835	1	185 g	1 - 1.5 m	Elastic lanyard
D	66839	2	285 g	1 - 1.5 m	Elastic lanyard

GOOD TO KNOW

When the tether is subjected to an overload (e.g. during a fall), an 'overload' indicator disconnects, revealing a label indicating that the tether must be replaced.

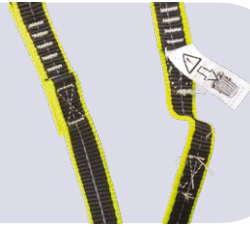

TETHER - ALUMINIUM DOUBLE SAFETY HOOK



- Rugged carabiner with double safety lever.
- Ultra-fast opening in a single gesture.
- Spout opening: 22 mm.
- Weight: 130 g.



	Ref.	Number of hooks	Weight	Lanyard Weight	Type of lanyard
A	66866	1	215 g	1 - 1.5 mm	Elastic lanyard
B	66867	2	340 g	1 - 1.5 mm	Elastic lanyard
C	66842	3	515 kg	1 m version + 1m extendable to 1.5 m 3 carabiners m	Double lanyard



3-HOOK DECK HARNESS TETHER

Ref. 67494

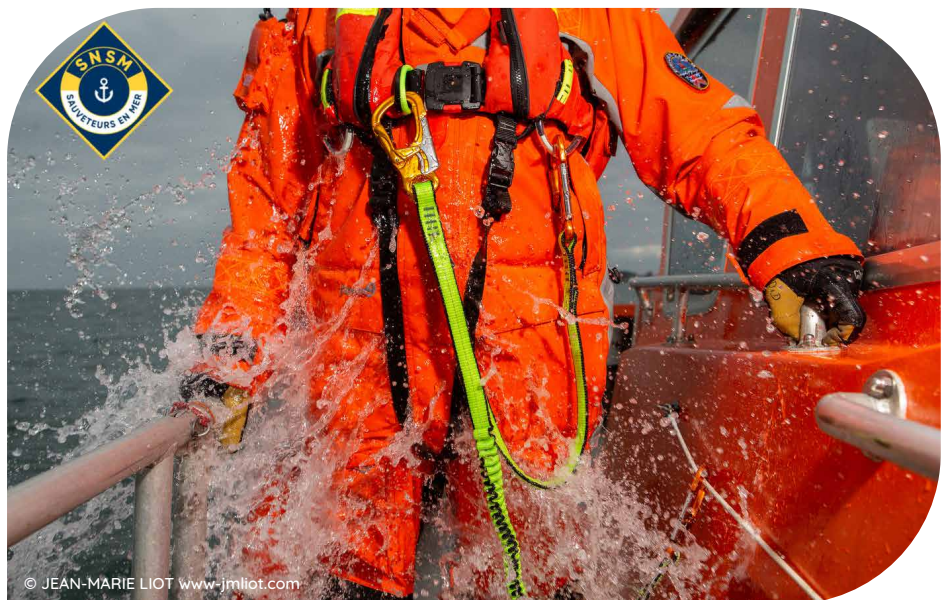

© JEAN-MARIE LIOT www.jmliot.com

Fundamentally committed to safety, Plastimo innovates with the SNSM (French Coastguards). On each new product development project, Plastimo surrounds itself with experts. To develop this specific tether, Plastimo's teams collaborated with the SNSM. The association asked Plastimo to co-develop and manufacture the tether that lifeguards will wear on all their operations. This co-development has resulted in a technical and innovative product, now accessible to all boaters.

- Single-strand design: unlike traditional tethers designed from 2 separate strands, the SNSM-Plastimo tether is constructed from a single strand over its entire length. This design offers optimum safety and performance.
- Flexible webbing with retroreflective thread for quick nighttime spotting.
- Double-safety aluminum snap hooks with anti-grip treatment, yellow for attachment to the harness and orange for attachment to the boat. A hard anodizing process optimizes the orange carabiners' resistance to scratching.

- 100 cm short flat strand, 110-175 cm long elastic strand.
- Two overload indicators: when the indicator comes loose, the tether needs replacing.
- Delivered with mesh storage pouch.
- Breaking load: 1.650 kg.
- Weight: 570 g.
- Designed by Les Sauveteurs en Mer (French Coastguards).

 **GOOD TO KNOW**

As with all fibers, even imperceptible aging occurs over time (UV, salt water, temperature). Ideally, you should winterize your lifelines. In any case, they should be changed regularly, and necessarily after a cumulative outdoor exposure time of 2 years.



RETRO-REFLECTIVE STRAP JACKLINE

- Ultra-flat polyester straps, 26 mm wide.
- Retroreflective thread for easy spotting.
- Fastening buckle at each end.
- Strength 2.400 DaN (2.450 kg).
- Sold in pairs, without shackle.
- A label is provided on the lanyard to indicate its in-service date.

Ref.	Lenght	Color
66984	6 m	White
66985	7 m	White
66986	8 m	White
66987	9 m	White
66988	10 m	White
66989	12 m	White
66990	14 m	White



CLASSIC STRAP JACKLINE

- Ultra-flat polyester straps, 30 mm wide.
- Strength 2.000 DaN (2.040 kg).
- Sold in pairs, without shackle.

Ref.	Lenght	Color
36214	6 m	Yellow
36215	7 m	Yellow
36216	8 m	Yellow
36217	9 m	Yellow
36218	10 m	Yellow
66981	12 m	Yellow
62102	14 m	Yellow

GOOD TO KNOW

The "Rescue" range is made up of products designed to help recover men overboard. Once the equipment has been dislodged, the boat simply encircles the castaway, enabling him to grab the buoy without having to swim, and then be brought back to

the boat. The products Rescue Buoy and Rescue Ring offer the added advantage of having a line coiled on a spool. This simple procedure also makes it possible to test the product outside an emergency maneuver, an additional guarantee of safety.



RESCUE LINE®

- Instantly usable jet line, consisting of an end coiled up in a bag for retrieving a man overboard. The Rescue Line also proves very useful for river sports such as canoeing, liferafting, etc. The jet line is weighted so it can be thrown by hand a reasonable distance, even in windy conditions. It has a loop at each end so both rescuer and castaway can attach themselves to the line. It's easy to repack in its bag.
- Colored bag yellow for easy spotting.
- Floating rope orange, Ø 8 mm.
- Rope breaking load: 400 kg (20 m) / 700 kg (36 m).

Ref.	Length
27020	20 m
P205834	36 m



RESCUE SLING®

Complete man-overboard recovery system for hoisting the castaway aboard, using a hoist if necessary. The design of the Rescue Sling® makes it one of the most effective man-overboard recovery systems on the market. Instructions for use are given on the back of the bag.

- Lift belt type buoy.
- Resistance: 200 kg.
- Belt buoyancy: 75 N.
- Retroreflective tape.
- Large enough to go over a lifejacket.
- Floating rope orange, Ø 8 mm, length 36 m.
- Easy to install. 3 fixing points on tube.

Ref.	Color
P205835	White
P205836	Yellow



HOLDER FOR PULPIT MOUNTING

Ref. 30766

Support designed for Rescue Line® 20 m and 36 m and able to accommodate any cylindrical object (Ø max. 11 cm).

- Height: 30 cm.
- Delivered with fixing screws.
- Composed of:
- 1 Plasticlip, adaptable to any horizontal or vertical tube, diameter from 18,5 to 25,5 mm.
- A stainless steel wire support.

SELECTED BY PLASTIMO



SILZIG MOB BUOY

Ref. 65559

Three-in-one man-overboard device: towing, buoyancy and reboarding assistance. Fast to deploy in the event of man overboard.

Cylindrical buoy provides better hydrodynamics for easier towing.

Depending on local applicable regulations, it can replace a horseshoe buoy (to be completed with a lighting device). Full-length harness strap, finished with a 40 mm-wide polyester buckle on one side, and a Wichard snap hook on the other.

- Coated polyester exterior, 650 g/m².
- 2 rigid handles (50 mm tubular polyester webbing) make it easy for on-board crew to pick up the castaway.
- Low bulk and easy on-board storage: always on

- station, the product fits perfectly on the lifeline, along the balcony or at the bottom of a RIB.
- Buoyancy: 142.2 N.
- Length: 200 cm / inside Ø: 8 cm.
- Weight: 1.5 kg.

RESCUE BUOY®

The principle is simple: connect an approved horseshoe buoy to a properly coiled end, easily uncoiled, and ready for use. Includes:

- Orange horseshoe buoy: buoyancy 147 N.
- 40 m of orange floating rope.
- Cover made of coated, UV-resistant canvas, with hanging lugs for balcony.
- Resistance of rope: 400 kg.
- Dimensions: height: 60 cm, width: 65 cm, thickness: 14 cm.
- Weight: 2.3 kg without light.

Model	Cover colour	
	Yellow	White
With floating light	27023	35716
Without floating light	27022	35717

PLASTIMO



PLASTIMO

INFLATABLE HORSESHOE BUOY

The inflatable horseshoe buoy consists of 4 parts:

- A bracket positioned on the boat's balcony.
 - An ABS case containing the lifebuoy.
 - The yellow polyurethane-coated fabric buoy (with retro-reflective stripes, floating anchor, lanyard).
 - The case is connected to the support by a lanyard.
- In the event of a man overboard, simply throw the case in the direction of the castaway. The tension exerted on the rope triggers the inflation and releases the buoy (which is no longer attached to the support). The box floats, attached to the buoy. Delivered with floating anchor and line. Buoyancy: 150 N.

Model	Color	
	White	Yellow
With light & whistle	65019	64888
Without light, without whistle	65018	64887

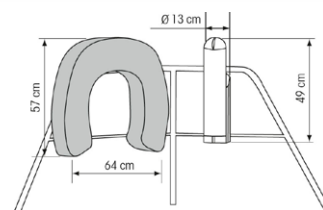

SELECTED BY **PLASTIMO**



RAIL MOUNTING KIT

Ref. 415010

- Balcony mounting kit for IOR Dan Buoy and inflatable horseshoe buoy.
- Kit with black polyamide fasteners and screws.
- For optimal mounting of the IOR Dan Buoy and inflatable horseshoe buoy set, provide 2 mounting kits.

PLASTIMO



UML MANUAL RE-ARMING KIT - 33 G

Ref. 40199

Complete UML refill kit to reactivate the inflation system of your inflatable vest or inflatable horseshoe buoy. Includes :

- CO2 33 g bottle.
- Green safety clips.

This kit is also suitable for our Plastimo inflatable horseshoe buoys.



HORSESHOE BUOY WITH REMOVABLE COVER

- Flotation 147 N by polyethylene foam.
- High-strength, washable PVC-coated fabric cover.
- Zip cover closure.
- Large opening suitable for virtually any build.
- Delivered with integral die and polyamide snap hook.
- The equipped buoy set includes a buoy, a reversing light and a stainless steel wire support.
- Dimensions: 43 x 62 x 11 cm (H x W x Th.).
- The yellow and orange buoys comply with Plaisance France regulations (Division 240).

Ref.	Color	Actual buoyancy	Model
63457	Yellow	147 N	Buoy only
63465	Yellow	147 N	Buoy set
63750	Orange	147 N	Buoy only
63751	Orange	147 N	Buoy set
63753	White	147 N	Buoy only
63754	White	147 N	Buoy set

Color	Complies with	Dimensions	Model	
			Buoy only	Buoy set
Yellow	Yachting Regulations France - Division 240	Height 43 x width 62 x thickness 11	63457	63465
Orange	Yachting Regulations France - Division 240	Height 43 x width 62 x thickness 11	63750	63751
White		Height 43 x width 62 x thickness 11	63753	63754

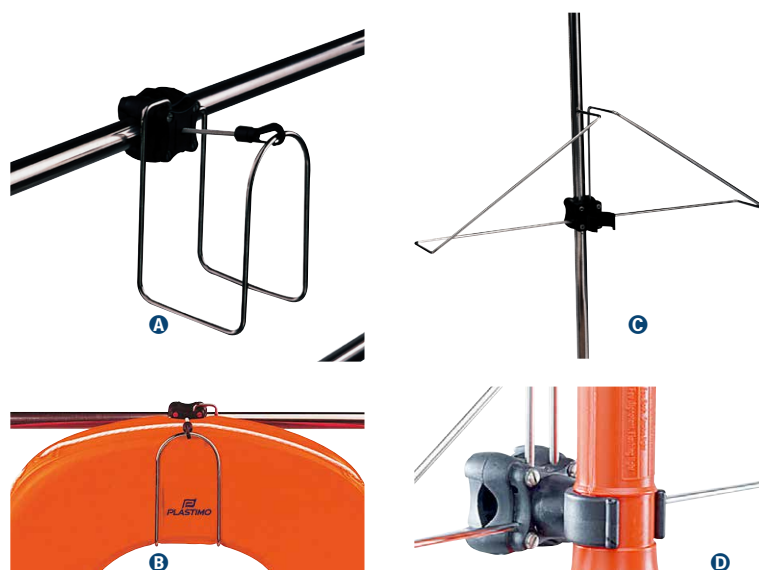

HORSESHOE BUOY RACK

Plastimo has developed this bracket to attach a horseshoe buoy to a tube :

- 1 Plasticlip, adaptable to any tube \varnothing 18.5 to 25.5 mm.
- 1 stainless steel wire support for horseshoe buoy up to 10.5 cm thick.
- 1 bungee cord + snap hook to hold the buoy (on buoy support alone).
- Delivered with fixing screws.

	Ref.	Model
A B	37800	Rack for buoy
C D	31437	Rack for buoy and light



SOLAS RING LIFEBOUY



SOLAS

SOLAS-approved lifebuoy. Indispensable on professional vessels, on docks and on the banks of rivers, ponds and waterways.

- Equipped with 4 retro-reflective strips.

- 3 m peripheral thread.
- Polyethylene structure, filled with polyurethane foam.
- Maximum stowage height: 30 m above the waterline.

Ref.	Model	External diameter	Inner diameter	height	Weight	Actual buoyancy
61967	Without throwing line	61 cm	41 cm	13.5 cm	2.7 kg	145 N
61968	Without throwing line	73 cm	44 cm	10.5 cm	3 kg	144 N
61970	With a 30 m throwing line	73 cm	44 cm	10.5 cm	3.5 kg	144 N
61969	Heavy model, without throwing line.	73 cm	44 cm	10.5 cm	4.6 kg	140 N



RING BUOY RACK

Ref. 37832

Composed of:

- 1 Plasticlip, adaptable to balcony or stanchion from Ø 18.5 to 25.5 mm.
- 1 stainless steel wire support receiving the buoy.
- 1 bungee cord + plastic snap hook to hold the buoy.
- Delivered with fixing screws.

SELECTED BY PLASTIMO



THROWING LINE FOR BUOY

- Floating polypropylene. Regulated to equip lifebuoys.
- Length : 30 m.
- Ø : 8 mm.

Ref.	Color
43767	Orange
53134	White

RESCUE RING SOLAS LIFEBOUY®

Ref. 35926

SOLAS-compliant product set:

- 1 crown buoy Ø 73 cm - buoyancy 144 N (ref. 61698).
- 1 Stella reversing floating light (ref. 196482).
- 30 m of floating yellow rope, polyethylene, Ø 10 mm.
- All contained in a UV-resistant, yellow-coated canvas cover with balcony hooks.
- Dimensions: Ø 750 mm x Th. 110 mm.





CONTAINER FOR SOLAS RING BUOY

Protecting and signalling buoys located on the coast or near inland waters (lake, river).

- Made of polyethylene.
- Fixed to a wall, post or tube.
- Compatible with crown buoy Ø 61 cm and 73 cm.
- Available with or without crown buoy Ø 73 cm.
- Dimensions (H x W x D): 75 x 85 x 26.5 cm.

Ref.	Model
62240	Container only
62241	Container with Ø 73 cm ring buoy and rope

CONTAINER WITH DOOR FOR RING BUOY

Case with door for crown buoy.

- For buoy Ø 61 and 73 cm.
- Made of polyethylene.
- Equipped with a window to view the presence of a buoy.
- Delivered with instructions for use label.
- Fixed to wall, post or tube.
- Box only, without buoy.
- Box dimensions: 90 x 90 x 28 cm (H x W x D).

Ref.	Model
64204	Container with door
68757	Spare handle



POLES FOR RING BUOY CONTAINER

Galvanized steel posts for attachment of crown buoy box.

- Compatible with boxes without or with door.
- Base dimensions: 30 x 30 cm.
- Piercing 1.2 mm.

Available in 2 sizes:

- Height 1.5 m, section 60 x 40 mm.
- Height 2 m, section 100 x 50 mm.



Ref.	Height
40213	1.5 m
59037	2 m

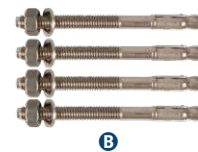

FIXING KITS FOR RING BUOY CONTAINER

Fastening flanges and bolts for crown buoy boxes. Compatible with boxes without or with door:

- Fastening flanges for 4.5 cm tube (set of 2).
- Fastening flanges for 6 cm tube (set of 2).
- Bolts for wall mounting (set of 4).

	Ref.	Model
A	59038	Fixing clamps for 4.5 cm rail
	40214	Fixing clamps for 6 cm rail
B	59039	Wall mounting kit

 **GOOD TO KNOW**

A system for locating a man overboard, the IOR Dan Buoy was made mandatory by World Sailing regulations on yachts participating in offshore races.

Have your inflatable IOR Dan Buoy or horseshoe buoy checked and serviced

To keep an inflatable Dan Buoy or horseshoe buoy in perfect working order, they should be checked and serviced regularly.

- Before each sea outing, their general condition can be visually checked. This examination includes a check on the condition of the main components (outer case, inflatable chamber, retro-reflective strips, CO2 cylinders - in particular check cylinder tightness-, inflation head, marker light - check the light's validity date-). Replace refill kit if necessary.
- A complete overhaul at regular intervals includes checking the inflation system and chamber tightness. We advise you to carry a spare kit per inflatable Dan Buoy or buoy.

SELECTED BY PLASTIMO

INFLATABLE IOR DAN BUOY

Assures man-overboard recovery and provides 150 N buoyancy.

Can be used as a "device for locating and assisting a person who has fallen overboard", replacing a horseshoe buoy.

Pole:

- Yellow nylon fabric, polyurethane coated.
- Inflated height above water: 1.98 m.
- Adjustable webbing seat to support the weight of a man overboard.
- Handle for easy gripping.
- A 0.75 cd auto-trigger light, 8-hour autonomy.
- Red and yellow flag (32 x 20 cm).
- Retro-reflective strips (200 cm²).
- Whistle.
- A rigid ballast with V-shaped reinforcements, acting like a keel for optimized stability.
- A floating anchor (28 x 28 cm).

Case:

- An ABS case, height 49 cm x Ø 13 cm.
- Weight: 3.8 kg.
- Optional balcony mounting kit.

Case assembly and pole deployment:

- The ABS case containing the IOR pole is positioned on the boat's balcony (optional kit: ref.415010).
- The case is connected to the support by a rope.
- In the event of a man overboard, simply throw the case in the direction of the castaway.
- The tension exerted on the rope triggers the inflation and releases the buoy
- (which is no longer connected to the support).
- The case floats, attached to the buoy.

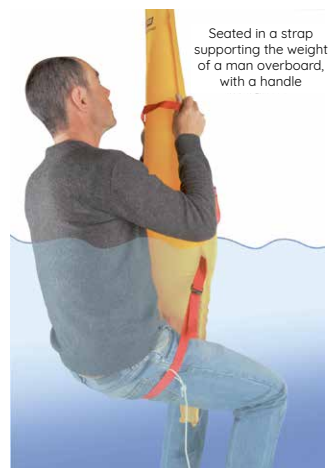

Seated in a strap supporting the weight of a man overboard, with a handle

Ref.	Model
61073	White container
63455	Yellow container

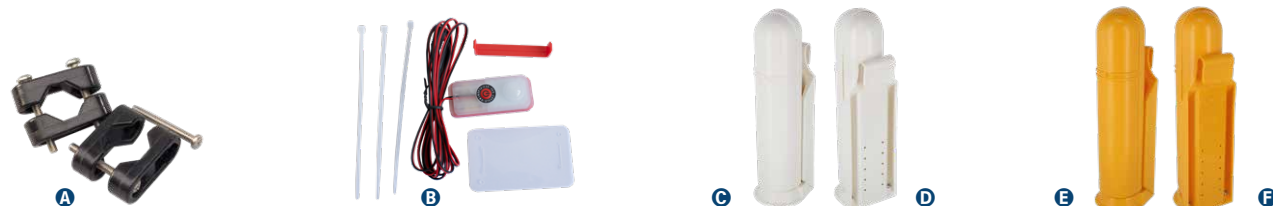
ACCESSORIES AND SPARE PARTS FOR IOR DAN BUOY

For poles: ref. 40203, ref. 177788, ref. 63455 and ref. 61073

	Ref.	Model
A	415010	Rail mounting kit
B	63456	Spare light kit
C D	52240	White spare canister
E F	53417	Yellow spare canister



INSHORE DAN BUOY

Ref. 176928

- Black fiberglass boom length 2.14 m.
- Float protected by rigid plastic housing.
- Lead ballast sheathed in yellow plastic.
- Pavillon and 25 mm reflective tape.
- 3 m Ø 8 mm floating rope.

TELESCOPIC IOR DAN BUOY ORANGE FLOAT

Ref. 55664

- Ergonomic design and very good stability.
- Compliant with race rule specifications.
- World Sailing - RSO compliant.

Composed of:

- 1 telescopic fiberglass pole with 1/4-turn lock.
- 1 soft orange PVC cylindrical float shock-resistant and ergonomic for a good grip (height 360 mm, Ø 180 mm x 80 mm).
- 1 red and yellow man overboard flag 480 x 330 mm. 4 m of floating yellow rope designed to be connected to a lifebuoy.
- 1 integrated lead ballast.
- 1 clamp and its toggle to keep the flag rolled up.

To make up the illuminated version, add the optional lighting kit. Runs on a 9 V battery. Situated 2.30 m above the water's surface, the light switches on automatically when the pole is thrown overboard by separating the pole and the clip-switch, which remains connected to the boat. To adapt the lighting assembly, simply slide its lower part into the tube positioned at the top of the pole.

Dimensions:

- Extended height: 3.52 m (3.64 m with lighting option).
- Folded height: 1.95 m (2.07 m with lighting option).
- Overwater height: 2.30 m (2.42 m with lighting option).

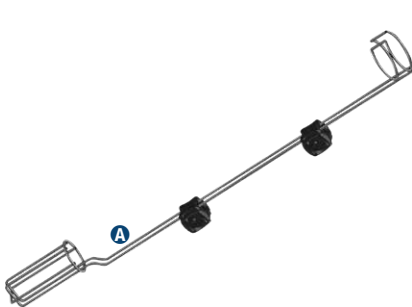

ACCESSORIES AND SPARE PARTS FOR TELESCOPIC IOR DAN BUOY

	Ref.	Model
A B	56397	Holder for telescopic IOR dan buoy
C	16205	Fixed light kit
D	66499	LED bulb for IOR telescopic dan buoy light.
E	10742	Spare flag for IOR dan buoy
F	16703	Fixing clip for IOR dan buoy flag



BUOYANT CUSHION

- Lightweight polyethylene foam covered by a heavy-duty coated fabric cover.
- Very comfortable, provides effective buoyancy aid in man-overboard situations.
- Peripheral straps ensure a secure grip.
- Easy care thanks to its washable cover: rinses in fresh water and dries in the sun.
- The red cushions comply with Division 240, and can replace a horseshoe buoy.

	Ref.	Modèle	Couleur	Longueur	Largeur	Hauteur	Flottabilité	Poids
A B	70600	Double - 1 person	Red	740 mm	370 mm	75 mm	150 N	0.62 kg
C D	70601	Double - 1 person	Navy blue	740 mm	370 mm	75 mm	150 N	0.62 kg
E F	70602	Triple - 2 persons	Red	1180 mm	395 mm	70 mm	300 N	0.97 kg



LIFEGUARD RESCUE BUOY

Ref. 70620

- Designed for sea or freshwater rescue.
- Its shape and weight have been defined to facilitate a precise throw to the person in difficulty.
- Once the victim is gripped to the buoy, the rescuer can tow the victim to the boat or shore. Made of polyethylene with polyurethane foam filling.

- Delivered with pull line and shoulder strap.
- Dimensions: 670 x 230 x 135 mm.
- Weight: 1.4 kg.



TRUMP AND MINI-TRUMP

- The simplicity of a foghorn and the power of a horn: over 100 dB effortlessly.
- Wear-free, unalterable, ecological and economical.
- Imperdable because it floats.
- The Mini-Trump is the more compact version.
- The Trump and Mini-Trump are regulatory.

Ref.	Model	Diameter	Weight	Length
27180	Trump - Comes in a tube canister, with lanyard and 2 spare diaphragms.	70 mm	140 g	195 mm
37894	Mini trump - Shell pack	50 mm	50 g	87-163 mm



FOG HORN

Ref. 16183

- Highly resistant polyamide.
- Length: 30 cm
- Diameter: 8 cm



COLREG 72 BRASS SHIP BELL

Ref. 417988

- Bell mounted on swing clamp.
- Removable polished brass bell.
- Mandatory on vessels equal to or greater than 20 m in length.
- Compliant with COLREG requirements.

SELECTED BY PLASTIMO



FOG HORN

- Loudness: 115 dB at 2 meters.
- Protects the ozone layer.
- From liquefied gas at the touch of a finger.
- Clip-on cartridge.
- Content: 300 ml

	Ref.	Model	Material
A	64388	Complete horn	Inflammable Gas
B	64389	Replacement cartridge	Inflammable Gas
C	64390	Complete horn	Non-Flammable Gas
D	64391	Replacement cartridge	Non-Flammable Gas

SELECTED BY PLASTIMO

WHISTLE

Ref. 52937

- Polypropylene whistle.
- Required on all lifejackets from 100 N.
- ISO 12402-8.
- Dimensions: 7.3 x 1.9 x 2 cm (L x H x W).
- Weight: 5 g.
- Sound power: 100 dB at 5 m.



SELECTED BY PLASTIMO

MOTRING CONE

Ref. 39552

- Folding, indicates motor running.
- Folded size: 47 x 33 cm.



ANCHOR BALL

- International signal, to be used to indicate that your boat is at anchor.
- Folds flat for easy storage.

Ref.	Diameter
16185	30 cm
39553	35 cm



LIFEBUOY STEADY LIGHT

- Designed to complement horseshoe buoys.
- Visibility range: 360°.
- Optimum visibility thanks to the position of the lighting optic 10 cm above the water.
- Autonomy: > to 6 hours.
- Runs on 4 x R20 alkaline batteries (not supplied).
- Dimensions: 360 x 100 mm (H x Ø)

Principle of operation of the fixed light:

- The spring is in permanent contact with the bulb base and the positive terminal of the batteries.
- The wire is in permanent contact with the bulb socket.
- At rest, the weight of the batteries compresses the spring and breaks contact with the negative terminal of the batteries and the wire.
- When the fire is thrown into the water, the geometry of the fire causes it to automatically position itself vertically.
- The batteries then slide into the tube, and come into contact with the wire that powers the bulb.

	Ref.	Model
A	57718	Lifbuoy steady light
B	57719	Lifbuoy steady light with bracket
C	54499	E10 krypton bulb for lifbuoy light



PLASTICLIP HOLDER

Ref. 37034

For attaching a reversing light or any object from Ø 40 to 45 mm, to horizontal or vertical tubing. Suitable for Ø 18.5 to 25.5 mm tubing. Delivered with fixing screw.



LED FLOATING SAFETY FLASHLIGHT ULTRA COMPACT

Ref. 64047



SOLAS

Features among the most compact and lightweight on the market. Automatically triggers when the light is uncoupled from its support. Can be used on platforms (76 m drop test validated).

- Visibility range: 360°.
- Autonomy: 2 hours minimum.
- Luminous intensity: 2 candela minimum.
- Weight: 91 g (light alone), 115 g (light and bracket).
- Dimensions light alone 75 x 78 mm (Ø x H).
- Dimensions light with holder 86 x 97 mm (Ø x H).
- Integrated lithium battery (5-year life).
- Delivered with polypropylene holder and cord (1 m long) to connect to a lifbuoy.
- SOLAS/MED and US Coastguards approved.



SIRIUS LED FLOATING SAFETY FLASHLIGHT

Ref. 63655



SOLAS

- Floating LED light with automatic ignition by contact with seawater.
- Can be stored in any position without risk of accidental ignition.
- Lithium battery and circuit enclosed in polyurethane foam to prevent oxidation.
- An essential accessory for horseshoe buoys.
- Delivered with stand and 2.65 m of cord.



SELECTED BY PLASTIMO

STELLA FLOATING LED-TYPE FLASH LIGHT



SOLAS

LED flashing reverse light.

- Very compact, low power consumption.
- LED flashing light 60 flashes/min.
- Light output 2 candelas.
- Autonomy 8h.
- Powered by 1 type D / LR20 battery (not supplied).
- Weight: 90 g (without battery).
- Dimensions: 160 x 80 x 80 mm.
- Accessory: clamp: ref. 45184 (for horizontal or vertical tube Ø 20 to 30 mm)



	Ref.	Model
A	196482	Light with activation in upside down position
B	45184	Mounting clamp

GOOD TO KNOW

Model	Stella	Sirius
Reference	196482	63655
Triggering	By overturning	By contact with seawater
Visibility range	360°	360°
Battery life	Around 8 hours	> 12 hours
Flash	60 flashes / minute	ND (50-70 flashes / minute)
Light intensity	2 candela	3 candela
Battery	Battery Alkaline type R20 x1 (not supplied)	Integrated lithium (lifetime 5 years)
Weight	90 g (without battery)	310 g
Dimensions	160 x 80 x 80 mm	220 x 100 mm (H x Ø)
Accessories	Support clip (ref. 45184)	-

DYE MARKER

- Easy to spot by day from a ship, plane or helicopter.
- The person in distress disperses the fluorescein in the water: it dissolves instantly, forming a fluorescent slick.
- Visible in clear weather up to 10 km by plane, remains visible for about an hour.
- Delivered in a welded waterproof bag, with attachment cord.
- Other formats than those shown below on request.



PLASTIMO



Ref.	Packaging	Dimensions
38861	Sealed sachet 40 g + blister pack	185 x 80 x 12 mm
301124	40 g sachet	185 x 80 x 12 mm
62236	80 g sachet	185 x 80 x 17 mm

SELECTED BY **PLASTIMO**

ADHESIVE REFLECTING TAPE



SOLAS

On a lifejacket, a harness, a garment: reflective strips combined with a glow stick optimize spotting.

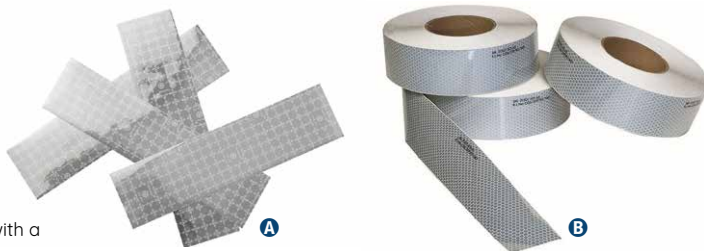

	Ref.	Model
A	60906	4 tapes L. 20 cm x W. 5 cm
B	206359	1 roll L. 45.7 m x W. 5 cm

SELECTED BY **PLASTIMO**

FLUORESCENT STORM JIB

The storm jib provides greater boat stability and makes it easier to find your way around at sea in difficult sailing conditions.

Designed by a master sailmaker and made from polyester, the storm jib features:

- A high grammage (380 g/m²).
- A small surface area (4 m², 5 m² or 6 m²).
- A collected shape.

- A highly visible color (fluo).
- It complies with OSR specifications. The fluo storm jib is equipped with a quick-release carabiner and can be quickly stowed on a releasable prop or any flying prop.
Delivered with storage bag.
Available in 3 sizes, for boats from 8 to 14 m.



Ref.	Surface	Luff	Leech	Foot
38009	4 m ²	4.68 m	3.32 m	2.53 m
38010	5 m ²	5.79 m	4.15 m	2.66 m
38011	6 m ²	5.90 m	4.52 m	2.80 m

SELECTED BY **PLASTIMO**

CABLE CUTTER

- Model designed for cable cutting.
- Indispensable aboard sailboats for cutting shrouds in the event of dismasting.
- Three models available.
- Not suitable for cutting chain.

	Ref.	Length	For cable
A	63579	45 mm	6-8
B	63580	60 mm	10-12
B	63581	90 mm	14-16



SELECTED BY PLASTIMO



FLOATING SAFETY KNIFE

- Floating knife with round tip.
- 7 cm stainless steel blade, rigid and serrated for cutting rope or net.
- Plastic handle.

	Ref.	Model
A	300744	Fix
B	11053	Foldable

BLUE FOLDING KNIFE SAFE

Ref. 67427



Versatile marine knife with safety lock, blue anodized aluminum handle, non-slip pad for good grip.

- Smooth blade.
- Folding stainless steel blade.
- Unfolded knife length: 17.5 cm.
- Folded knife length: 10.5 cm.
- Blade length: 7 cm.
- Weight: 80 g.
- Color: blue and black.

Holster: nylon fabric with belt loop.

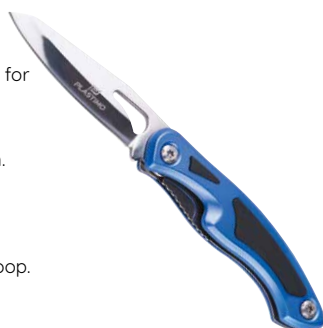

SELECTED BY PLASTIMO

SAFETY KNIFE MILSPEC HPA

Ref. 71312



The FSK MILSPEC safety knife is made of AUS8 steel and Teflon. Its blade is 3 mm thick. Its cutting power is extraordinary, thanks to the combined effectiveness of its razor-sharp edge and the toothed part of the blade (1st third). This flat, space-saving knife is extremely lightweight. Its ergonomics are perfect, and its carrying possibilities are multiple.

- Complete kit enabling the sheath to be attached to a strap or to a MOLLE or other system.
- Powerful and secure Sheepfoot profile.
- Black color.
- Delivered with its sheath.
- Total length 20 cm.

SELECTED BY PLASTIMO

HAND LEAD LINE

- Lead sinker line with capillot every meter and color change every 10 m.
- Exists in 30 m and 50 m.
- Braid diameter: 4 mm.
- Lead sinker 0.615 kg with suet reserve.
- Total weight: 905 g in 30 m / 1.030 g in 50 m.

	Ref.	Modele
	417053	30 m
	39258	50 m

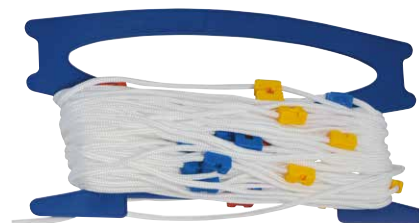

ST. STEEL KNIFE

Ref. 36087



Ultra-flat, all-stainless steel knife slips easily into a pocket. 100% Italian quality.

- Folding serrated stainless steel blade.
- Shredder.
- Splicer.
- Cap lifter.
- Unfolded knife size: 18.5 cm.
- Folded knife size: 11.5 cm.
- Blade size: 7.5 cm.



SAFE MULTI-TOOL

Safe multi-tool pliers with safety lock: smooth blade, serrated blade, saw, pliers, file, wire cutter, splicer, bottle opener, can opener.

	Ref.	Color
A	67426	Wood
B	67425	Black

HAND PUMP

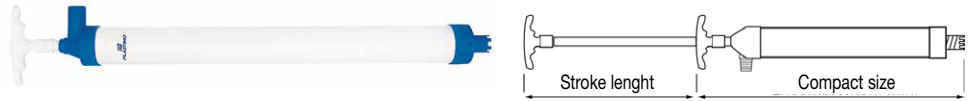

Pump sold alone or with 1 m hose. Spare parts: Hose Ø 25 mm and length 25 m for hand pump.

Ref. Pump alone	Ref. Pump + with 1 m hose	Flow	Min. dimensions	Stroke
14089	27074	0.50 L/min	480 mm	330 mm
14105	27075	0.75 L/min	630 mm	480 mm
14090	27076	1 L/min	790 mm	640 mm



WOODEN PLUGS

Set of conical wooden pegs of various heights and diameters.

Ref.	Description
16323	9 conical pins: 2 x height. 40 mm x Ø 10-4 mm* 2 x height. 50 mm x Ø 16-8 mm* 2 x height. 60 mm x Ø 22-14 mm* 2 x height. 70 mm x Ø 30-18 mm* 1 x height. 80 mm x Ø 35-25 mm*
10103	9 conical pins: 3 x height 110 mm x Ø 29-19 mm* 3 x height 110 mm x Ø 39-29 mm* 3 x height 110 mm x Ø 50-40 mm*
47428	6 conical pins: 2 x height 60 mm x Ø 22-15 mm* 1 x height 115 mm x Ø 22-19 mm* 1 x height 110 mm x Ø 39-29 mm* 2 x height 110 mm x Ø 49-39 mm*

* Maximum-minimum diameter

SELECTED BY PLASTIMO

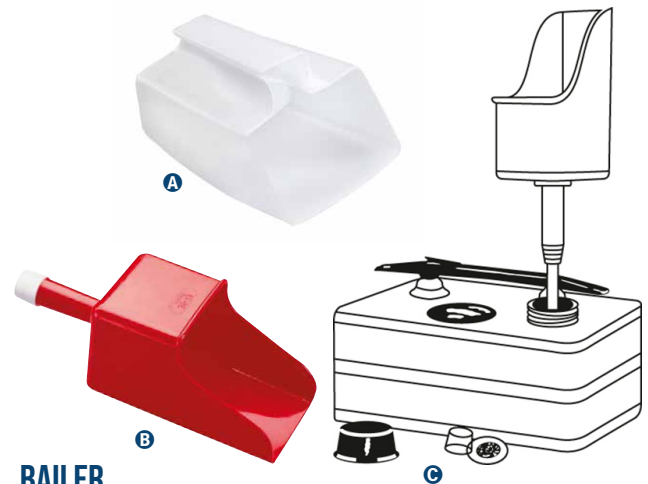

BAILER

Plastic bailer flexible or rigid.

	Ref.	Model	Dimensions
A	16207	Floating, flexible bailer	180 x 125 mm
B C	44677	Bailer-funnel with filter	290 x 110 mm



PLASTIC BUCKET

- Plastic bucket, eye handle.
- Capacity: 10 L.
- Exists without end (delivered individually) or with end (delivered by 5).



Ref.	Model	Packaging
14375	Bucket without cord	1
17576	Bucket with rope	5

SELECTED BY PLASTIMO

RUBBER BUCKET

Ref. 71656

Outigom rubberized bucket, 11 liters with galvanized steel eye handle.

- Supple rubberized material.
- Made from over 95% recycled materials.
- Properties (strength, flexibility) very similar to natural rubber but without the disadvantages associated with weight.
- Frost, heat and impact resistant.
- Molded grip.



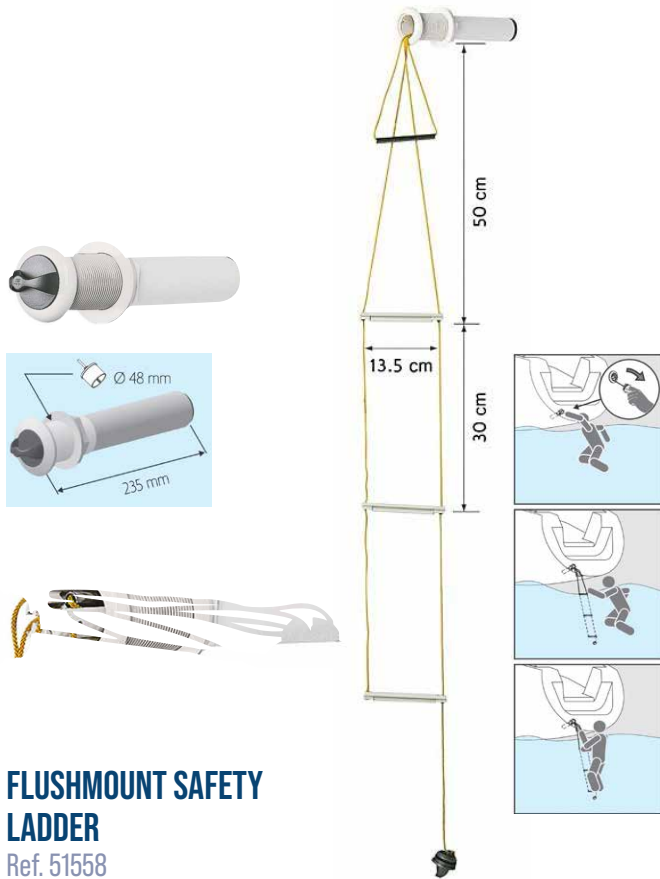

FLUSHMOUNT SAFETY LADDER

Ref. 51558

Allows one person to climb back aboard easily without external assistance. For everyday use (swimming), or in the event of a man overboard. Composed of 3 polypropylene steps and a stainless steel handle connected by a highly resistant, easy-to-spot end (yellow polyester Ø 3 mm). The ladder is stored in a polyamide tube closed by a gray polypropylene plug for a perfect seal. The person who has fallen overboard removes the plug, deploys the ladder, and hoists himself aboard.

- Lightweight.
- Easy flush mounting (like a through-hull).
- Store out of the sun.

To be mounted on transom or stern skirt (sailboat or motorboat), very slightly above the waterline.

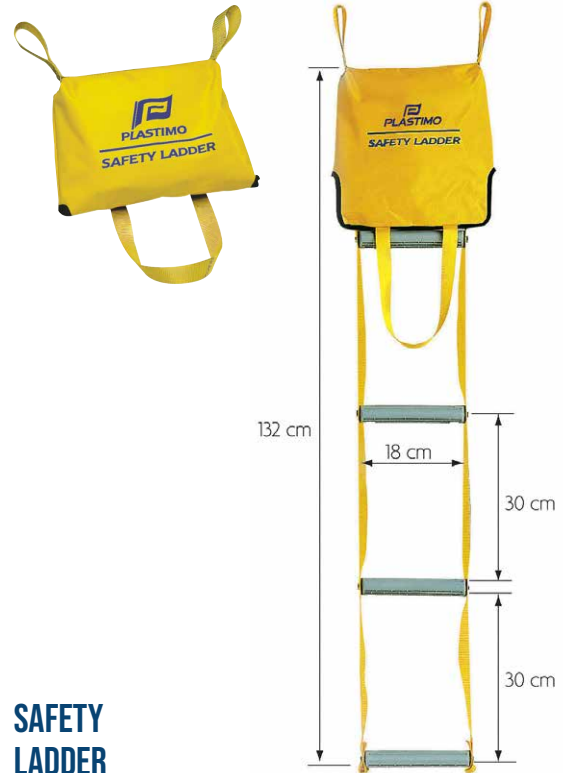

SAFETY LADDER

Designed to improve safety on board, this ladder comes in a bag with two handles: one is used to secure the bag along the freeboard or transom, the other allows the person who has fallen in the water to trigger the opening of the bag, releasing the ladder to help them back on board.

- Large, grooved steps for safe, comfortable foot support.
- Lightweight
- Available in 2 lengths.

Ref.	Model
29008	4-step emergency ladder
29009	5-step emergency ladder



SEA ANCHOR

- Foldable, heavy-duty models.
- Various uses depending on the model.

	Ref.	Dimensions	Model	Material	Rope length
A	25354	Length 80 cm - Width 35 cm	For IOR pole, horseshoe buoy, etc.	Polyester fabric	-
B	52957	Length 60 cm x Diameter 40 cm	For SOLAS liferafts, up to 10-person	PVC-coated grid fabric	30 m
C	52559	Length 90 cm - Width 75 cm	For SOLAS liferaft, up to 10-person	PVC coated fabric	30 m
D	18668	Length 120 cm x Diameter 60 cm	For sailing boats and motor boats	PVC coated fabric	-



FIRST AID SET

- Packaged in a soft, fully waterproof pouch, Crewmedic first-aid kits have been specially designed to provide essential first-aid equipment while waiting for the nearest professional help to arrive.
- Available in 3 versions: 30, 60 or 180 minutes.
- Equipped with a hanging cord, Crewmedic kits float and feature a hermetic closure system.
- Validity: 4 years.

	Ref.	Model
A	59041	30-minute model. Ideal for small boats, wind or kite surf, dinghies, jet-skis. Recommended for the immediate emergency situations. Dimensions : 17 x 10 x 3 cm.
B	59042	60-minute model. Suitable for boats up to approx. 7 m. Recommended for coastal navigation. Dimensions : 31 x 14 x 6 cm
C	59043	180-minute model. Complete set, suitable for coastal or cross-channel use. Dimensions : 24 x 24,5 x 10 cm.

GOOD TO KNOW

Contents	30-minute model	60-minute model	180-minute model
Antiseptic wipes	4	4	10
Adhesive dressings (standard)	10	20	20
Safety pins	-	12	12
Eye compress	1	1	2
Physiological solution	1	2	2
Sterile adhesive compress wide	1	2	5
Special burn gel	1	1	1
Finger bandage	1	1	1
Resuscitation face shield	1	1	1
First aid assistance	1	1	1
Vinyl gloves	-	1 pair	1 pair
Triangular scarf	-	1	2
Sterile medium pressure dressing	-	1	2
Sterile medium pressure bandage	-	5	5
Instant ice pack	-	1	1
Bandage dispenser	-	1	1
Wide sterile compressive dressing	-	-	1
Rescue blanket	-	-	1
Crepe band	-	-	1
Sterile gauze compress	-	-	1 x 5
Special burn dressing	-	-	1
Light sticks (30 minutes)	-	-	1

SELECTED BY PLASTIMO



ANTI-SEASICKNESS WRIST BAND - BOW OF 12 PAIRS

Ref. 1010400

- Natural method to effectively combat nausea for all seasickness sufferers.
- Based on the principle of acupressure (acupuncture without needles), with no side effects.
- Suitable for adults, pregnant women and children.
- One-size-fits-all elastic wristbands.
- Washable and reusable.
- Presented in a plastic case.
- Sold in pairs.



FIRST AID KITS

- First-aid kits for on-board first aid while waiting for professional help.
- 3 first-aid kits for coastal, semi-high-seas and river, or high-seas navigation.
- Presented in plastic cases.

Our first-aid kits contain medical supplies. These products and instruments can be used to treat most minor incidents as first aid. We recommend that skippers add to their on-board first-aid kit according to the sailing schedule and the specific needs of certain crew members. References 66002, 66003 and 66004 comply with French regulations for pleasure boating (Division 240).



	Ref.	Model	Navigation area	Description
A	66002	Coastal	Coastal	Coastal navigation at sea: less than 6 MN from a shelter. Gray case, 22 x 27 x 7 cm. Weight 0.400 kg
B	66003	Offshore/Waterways	Offshore	Semi-coastal navigation at sea and inland waters: 6 to 60 MN from a shelter. White case, 22 x 27 x 7 cm. Weight 0.700 kg
C	66004	Ocean	Blue water	Offshore sailing: beyond 60 MN from a shelter. White case, 37 x 25 x 9 cm. Weight 1.500 kg
D	10320	Offshore	Blue water	Recommended more than 3 MN from the coast. Contains essential first-aid supplies. Dimensions: 26 x 17 x 9 cm
E	10321	Coastal	Coastal	Recommended up to 3 MN from shore. Planned to meet the needs of minor incidents on board. Dimensions: 26 x 17 x 9 cm
F	10322	Basic	Basic	Recommended for small boats and tenders. Dimensions: 20.5 x 14 x 5.5 cm

GOOD TO KNOW

Content	Coastal	Offshore/ Fluvial	Ocean	Contenu	Basic	Coastal	Offshore
	A	B	C		D	E	F
English/French medical guide	1	1	1	Wall mount	-	-	Included
Sterile gauze compresses 7.5 x 6.5 cm	5	5	5	First aid advice (English)	1	1	1
Adhesive dressings to cut 1m x 6 cm	1	1	1	Triangular bands	-	2	3
Adhesive dressings 1.9 x 7.2 cm	10	10	10	Single-use thermometers (°C)	-	-	5
Small round adhesive plasters	10	10	10	Survival blanket	-	-	1
Paraffin bandages 10 x 7.5 cm	-	-	8	Plastic fingers	-	-	10
Plaster roll 5 m x 1.25 cm	1	1	1	Scissors	-	1	1
Adhesive restraint tape	-	-	1	Stainless steel pliers	-	-	1
Elastic cohesive tape 4 m x 10 cm	-	1	1	Safety pins	6	6	6
Hemostatic cushion	-	1	1	Assortment of dressings	10	10	20
Chlorhexidine sachets	-	10	10	Adhesive sutures	-	-	10
Hydro-alcoholic gel (100 ml bottle)	-	1	1	Eye compress	-	-	1
Examination gloves	-	5 pairs M 5 pairs L	5 pairs M 5 pairs L	Sterile gauze compresses (7.5 x 7.5 cm)	3	3	1
Survival blanket	-	1	1	Stretchable non-sterile gauze strips	2	1	3
Safety pins	-	-	12	Sterile bandages	2	4	4
Pair of scissors	-	-	1	Cleaning wipes	2	12	10
Electronic thermometer	-	-	1	Waxed sterile compresses	-	-	3
				Microporous sponges	1	-	1
				Antiseptic cream (15 g tube)	1	1	-
				Double-sided dressings	1	2	2
				Sterile woven adhesive dressing	-	1	-

 GOOD TO KNOW

The ultimate safety feature: **food on board**, essential for any sailor likely to be away from help for any length of time.

Drinking water and survival rations are part of the grab bag in addition to distress signals, a portable VHF, personal beacons etc...

Plastimo food supplies comply with all international standards or recommendations governing maritime, aeronautical as well as humanitarian activities managed by NGOs.

It's the ideal equipment in the grab bag to complement a coastal or offshore liferaft (- 24h).

Certifications and approvals:

Survival regulations: SOLAS 74-94, ISO 18813:2006, IMO MSC 48(66) LSA Code, RINA. Guaranteed GMO-free cereals. Certified Halal.

Drinking water: SOLAS 74-94, ISO 18813:2006, IMO MSC 48(66) LSA Code. MSN1676(M). reg. 99 Marine Marchande. Bureau Veritas certified 0062-23889 N°8960 14 5310350 (NATO).

SURVIVAL FOOD RATIONS



SOLAS

Ideal equipment in the grab bag to complement an inshore or offshore liferaft -24 hours.

- Presented in individually vacuum-packed tablet-rations.
- One 515 g box = 10.410 kJ = 2.392 kcal.
- One box contains 7 rations of 73.5 g wrapped in an aluminized pouch.
- In survival situations, the recommended daily consumption is a maximum of 3 rations per person.
- Validity period: 5 years.
- Reference 301541 corresponds to the quantity per person required by most racing classes.



Ref.	Packaging	Weight
301541	1 box of 7 biscuits (73.5 g each)	515 g
14116	1 Box = 20 Each	10.3 kg

 GOOD TO KNOW

Why packaged water rather than bottled water?

Packaged drinking water undergoes a special treatment that guarantees it will remain pure and bacteria-free for 5 years*, regardless of temperature variations (from -30°C to +40°C). Commercially bottled drinking water is considered pure for a maximum of 2 years.

** For this reason, water is one of the items replaced in a life liferaft during the mandatory tri-annual overhaul.*

FRESH WATER IN VACUUM SACHET



SOLAS



- Sourced from very pure water, survival water is treated and packaged under the regular control of an independent organization (Bureau Veritas).
- Presented in individual 125 ml sachets for easy, controlled consumption.
- Packaging in tri-layer aluminized polyethylene film guarantees bacterial non-contamination of the water, as well as very high mechanical resistance: sachets are designed to withstand compression in a life liferaft, as well as a 35 m drop (SOLAS nome) without puncturing or exploding. Duration of validity : 5 years.
- Reference 300448 corresponds to the quantity per person required by most racing classes.

Ref.	Model	Packaging	Volume
300448	Fresh water in vacuum sachet 1.5 L (12 x 125 ml)	12 sachets of 125 ml in a sealed pouch (1.5 L).	1.5 L
35541	Fresh water in vacuum sachet 14 L (112 x 125 ml)	1 Box = 28 Each	14 L
21368	Fresh water in vacuum sachet 15 L (120 x 125 ml)	1 Box = 5 Each	15 L



PLASTIMO

happy boating to you!

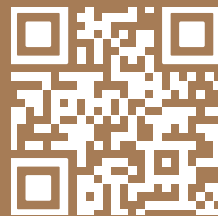

Discover EZ Range

IT'S SO EZ!

THE RELIABLE SOLUTION FOR QUICK AND CONTROLLED INSTALLATION.

ANCHORS

A good anchor is your best insurance policy. What is a good anchor ? An anchor that enables you to face all situations safely : open berth in a nice calm weather, or "emergency" berth when the boat drifts towards the rocks.

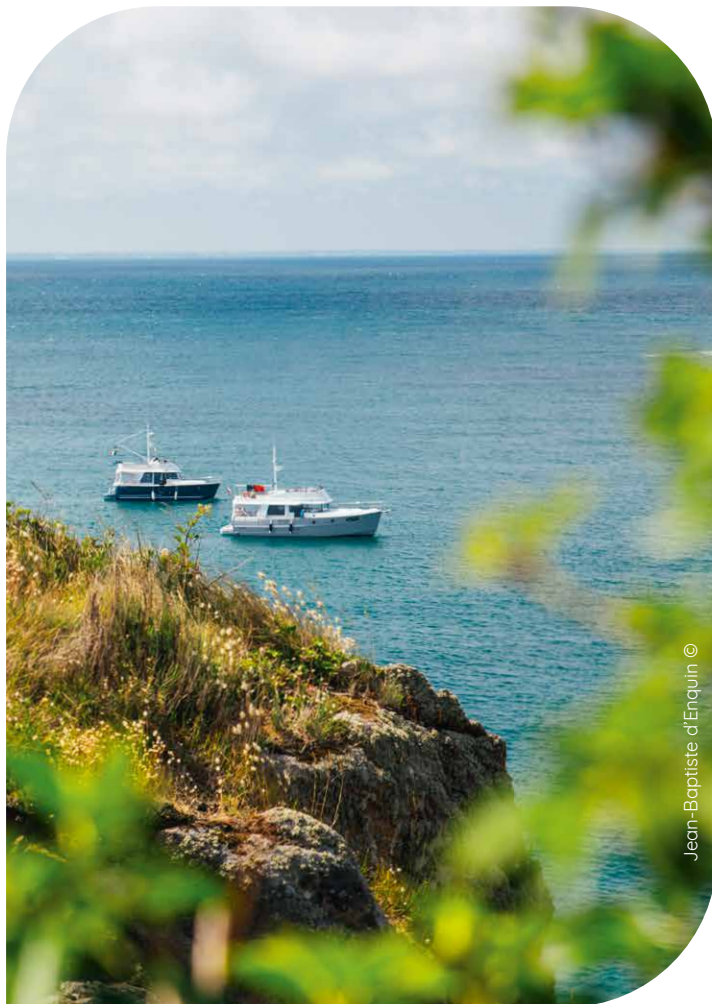

THE BASIC RULES OF A GOOD ANCHORING SYSTEM

Do not overlook the importance of every element in your anchoring system : it is only by selecting top quality elements and assembling them correctly together that one obtains a perfectly reliable anchoring.

- **Chain** : diameter must be generous and length at least 5 times the boat length (see table).
- **Rope** : opt for polyamide, which provides good abrasion and tension resistance, with a good stretching capacity (18 to 25%) to absorb the surges that waves impact on the anchor.

Numerous tests carried out throughout the world have demonstrated that the geometric proportions of the anchor are more important than its actual weight.

Anchors such as the Kobra, bites into the seabed within seconds due to its weighted tip and holds very well thanks to its broad shoulders. Tests carried by French magazines Voile Magazine and Moteur Boat Magazine gave clear evidence that "a 6 kg Kobra anchor held a 600 kg traction load, in a mixed sand-mud seabed", which corresponds approx. to the traction exerted by a 42-knot wind on a 9 m boat, where a 12 kg anchor is traditionally recommended.

When the local regulation imposes a minimum anchor weight for a given size of boat, it is imperative to follow strictly the regulation. In the absence of a specific regulation, we suggest that you use our table as a guide, to select your primary and secondary anchors.



The anchor weight is only given as an indication, per length of boat. However, this criterion alone is not sufficient, and your anchor selection should also recognise the specific construction of your vessel.

Which anchor for which boat and use ?

Max. boat length	Boat displacement	Min. anchor weight		Ø Shackle	Ø Chain	Ø Nylon rope
Dinghy, tender, Optimist	-	2 kg	4,4 lb	8 mm	6 mm	6 mm
Dinghy, inflatable boat, small catamaran up to 4 m	300 kg	3,5 kg	7,7 lb	8 mm	6 mm	6 - 8 mm
Boat up to 5.50 m	800 kg	6 kg	13 lb	8 mm	6 mm	10 mm
6,50 m	1000 kg	8 kg	17 lb	8 mm	6 - 7 mm	10 mm
7,50 m	2000 kg	10 kg	22 lb	10 mm	8 mm	14 mm
9 m	3000 kg	12 kg	26 lb	10 mm	8 mm	14 mm
10,50 m	4500 kg	14 kg	31 lb	10 mm	8 mm	14 mm
12,50 m	8000 kg	16 kg	35 lb	12 mm	10 mm	18 mm
16 m	12000 kg	20 kg	44 lb	12 mm	10 mm	18 mm
18 m	16000 kg	24 kg	50 lb	16 mm	12 mm	22 mm
20 m	20000 kg	34 kg	75 lb	16 mm	14 mm	24 mm
25 m	30000 kg	40 kg	88 lb	16 mm	14 mm	24 mm
+ 25 m	+ 30000 kg	60 kg	140 lb	18 mm	16 mm	28 mm

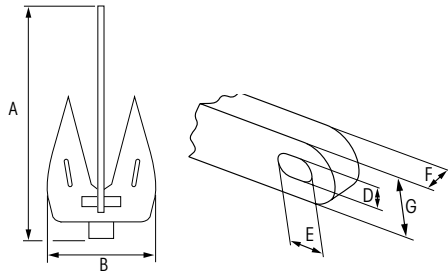
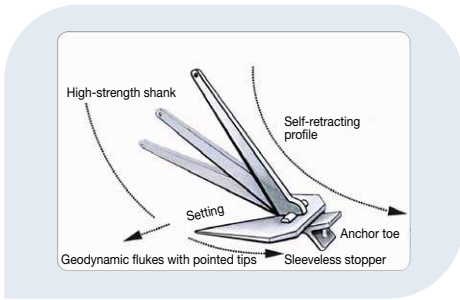

BRITANY ANCHOR

Very high-strength galvanized steel (55 kg of steel per mm²). Instant grip:

- To prevent jamming, the Britany has no rear clamp.
- To prevent a stone from getting stuck, the Britany has no articulation cage.
- Very fine tines: an essential condition for fast grip in the hardest ground.
- Geodynamic paddles, ensuring a perfect hold.
- Ultra-strong one-piece weight, which ensures perfect resistance even to strong lateral traction and avoids going backwards.
- Narrow heel, the primary condition for good burial.

The weight of the anchor is given as a guide, depending on the length of the boat.

Reinforcement ribs from 35 kg./ul>Reinforcement ribs from 35 kg./ul>Reinforcement ribs from 35 kg.



The Britany is the only flat anchor without a hinge cage, eliminating any risk of shank jamming due to clogging and ensuring instant setting.

Ref.	Maximum boat length	Weight kg	A mm	B mm	D mm	E mm	F mm	G mm
16456	3 m	2 kg	410	185	10	20	12	22
16457	4 m	3,5 kg	498	219	10	20	14	26
16458	5,5 m	6 kg	547	270	12	24	14	30
16459	6,5 m	8 kg	647	312	12	24	14	30
16460	7,5 m	10 kg	732	347	14	28	16	37
16461	9 m	12 kg	786	347	14	28	18	41
16462	10,5 m	14 kg	788	368	14	28	18	41
16463	12,5 m	16 kg	841	368	16	32	20	41
16464	16 m	20 kg	910	414	16	32	22	41
16465	18 m	25 kg	970	451	16	32	22	44
16466	20 m	35 kg	1038	522	19	38	22	52
16467	25 m	45 kg	1085	550	25	50	25	64
16468	+ 25 m	65 kg	1196	594	28	56	30	72
16469	+ 25 m	90 kg	1297	666	31	62	35	80

GRIP ANCHOR

Hot-dip galvanized steel.
3 m boats : Canoe , Tender
4 m boats : Dinghy , tender

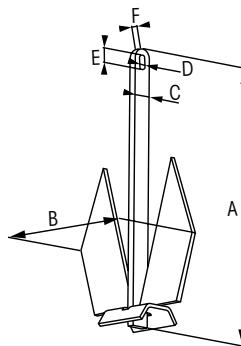

Ref.	Maximum boat length	Weight kg	A mm	B mm	C mm	D mm	E mm	F mm
16453	3 m	2,5 kg	390	186	24	12	24	14
16454	4 m	5 kg	482	244	35	12	24	14
16455	5,5 m	7 kg	580	313	40	12	24	14
26894	6,5 m	9 kg	630	348	45	16	32	16

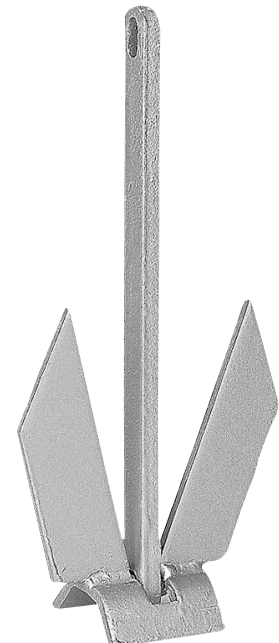



PLASTIMO

happy boating to you!



Discover our
anchors



PLASTIMO ANCHORS

DESIGNED FOR QUICK ATTACHMENT AND OPTIMAL HOLD ON ALL SURFACES



DC ANCHOR

High holding power plow-type anchor. Lloyds certified anchor. The shape of the rod combined with a wide base and weighted tip guarantee quick release and immediate burial thanks to a very low center of gravity. Fits perfectly on the davit. High-quality, hot-dip galvanized steel binder. Limit of elasticity 420 MPa.



Ref.	Boat length	Weight kg	A mm	B mm	C mm	H mm	D mm	E mm	F mm	G mm
63714	6-9 m	4 kg	514	303	230	217	16	35	8 ± 0,35	32
63715	9-12 m	6 kg	593	350	265	254	16	35	10 ± 0,4	32
63716	12-15 m	10 kg	695	410	310	293	19	42	12,1 - 13,5	38
63717	15-18 m	16 kg	812	482	362	339	19	42	12,1 - 13,5	44
63718	18-20 m	20 kg	877	518	392	370	24	48	16 ± 0,4	48
63719	20-21 m	25 kg	945	558	415	397	24	48	16 ± 0,4	52
63720	21-23 m	32 kg	1023	603	445	425	26	62	18 ± 0,5	56
63721	23-24 m	40 kg	1099	665	489	461	24	48	20 ± 0,5	52
63722	24-27 m	50 kg	1175	695	523	486	24	48	20 ± 0,5	52
63723	27-30 m	63 kg	1270	760	567	537	28	56	22 ± 0,5	60



KOBRA ANCHOR

Fast-burial anchor with very high holding power, thanks to its weighted tip and extra-wide base. The Kobra's exceptional performance results from its special geometry, allowing you to safely select one to two sizes below the usually recommended standards. Very high-strength 55kg/mm² galvanized steel.

• **Kobra 1 with tilting rod (patented)**

The Kobra anchor can remain stationary on the davit or be easily stowed in the anchor locker thanks to its tilting rod.

Very efficient, it can also be used with a simple leaded line in "picnic" anchoring, avoiding unnecessary effort in the absence of a windlass.

• **Kobra 2 with fixed rod**

Anchor delivered with unbolted rod (for transport).

To be bolted before use.

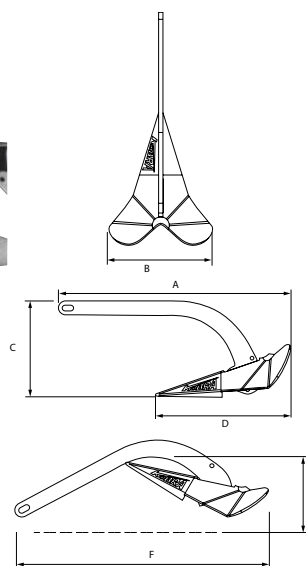

Ref.	Model	Boat length	Weight kg	A mm	B mm	C mm	D mm	E mm	F mm
39140	Galvanised tilting KOBRA 1	4 m	2 kg	408	182	168	238	132	441
39141	Galvanised tilting KOBRA 1	6 m	4 kg	523	236	218	310	170	567
37680	Galvanised tilting KOBRA 1	8 m	6 kg	592	270	247	359	190	638
37688	Galvanised tilting KOBRA 1	10 m	8 kg	640	294	265	388	205	693
37649	Galvanised tilting KOBRA 1	12 m	10 kg	698	322	290	424	222	758
49223	Galvanised fixed KOBRA 2	13 m	12 kg	739	341	305	452	234	800
49226	Galvanised fixed KOBRA 2	14.50 m	14 kg	789	361	330	500	254	852
49229	Galvanised fixed KOBRA 2	16 m	16 kg	815	374	340	503	259	881
49296	Galvanised fixed KOBRA 2	18 m	20 kg	863	409	366	536	275	940
49304	Galvanised fixed KOBRA 2	20 m	25 kg	937	456	395	586	296	1023
49360	Galvanised fixed KOBRA 2	25 m	35 kg	1029	483	446	644	331	1121



ANCHOR FHD GALVA

Galvanized steel: heat-treated to increase tensile strength.

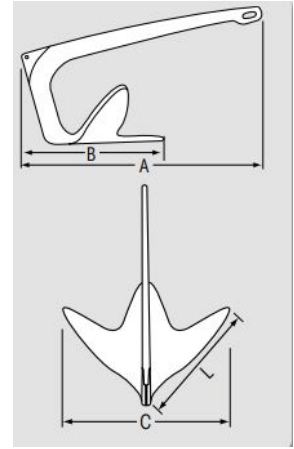
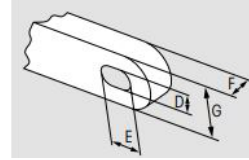

Ref.	Boat lenght	Weight kg	A mm	B mm	C mm	L mm	E mm	D mm	F mm	G mm
P206005	3,50 m	2,5 kg	150	360	200	135				
P206006	5 m	5 kg	470	260	300	215	24,5	9	9,7	29
P206007	6,5 m	7,5 kg	470	300	330	240	27,5	14,2	12,5	33,8
P206008	7,5 m	10 kg	520	315	370	265	30,6	13	13	32,5
P206009	10,5	15 kg	620	365	440	320	38	14,5	14,5	38
P206010	16 m	20 kg	690	390	450	330	40	22	22	51
P206011	19 m	30 kg	750	440	570	410	45	17	20	50



FHD ANCHOR STAINLESS STEEL

316L stainless steel: steel treated with pickling and passivation baths

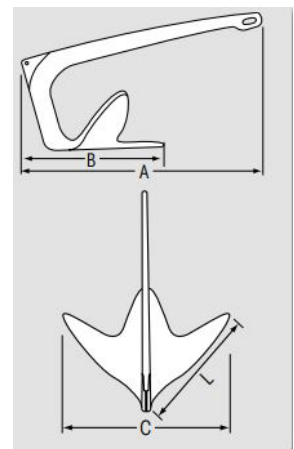
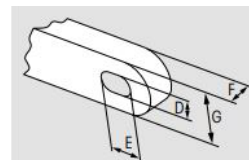

Ref.	Boat lenght	Weight kg	A mm	B mm	C mm	L mm	E mm	D mm	F mm	G mm
P206012	5 m	5 kg	470	260	300	215	24,5	9	9,7	29
P206013	6,5 m	7,5 kg	450	285	340	240	27,5	14,2	12,5	33,8
P206014	7,5 m	10 kg	520	315	375	270	30,6	13	13	32,5
P206015	10,5 m	15 kg	615	355	440	310	38	14,5	14,5	38
P206016	16 m	20 kg	650	395	460	330	40	22	22	51
P206017	19 m	30 kg	765	450	515	375	40	22	22	51

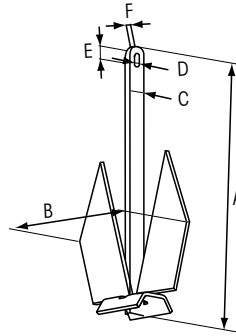

FLAT ANCHOR

The most common anchor; a must-have base. Hot-dip galvanized steel.

Ref.	Boat length	Weight kg	A mm	B mm	C mm	D mm	E mm	F mm
401040	5,50 m	4 kg	410	235	33	12	23	13
401041	5,50 m	6 kg	470	270	40	14	28	15
401042	6,5 m	8 kg	510	305	40	16	32	15
401043	7,5 m	10 kg	580	320	40	16	32	15
401044	9 m	12 kg	590	340	40	16	32	20
P205998	10 m	14 kg	630	375	40	20	40	20
401047	11 m	15 kg	650	375	50	20	40	20
P205999	11,50 m	16 kg	700	375	50	20	40	20
401048	16 m	20 kg	730	400	60	20	45	20
401049	20 m	30 kg	810	500	60	25	50	27
401054	25 m	40 kg	910	510	67	25	50	27
404955	18 m	25 kg	755	440	58	25	50	25
414194	+ 25 m	50 kg	1000	560	85	26	55	27
414195	+ 25 m	75 kg	1135	620	88	35	70	27

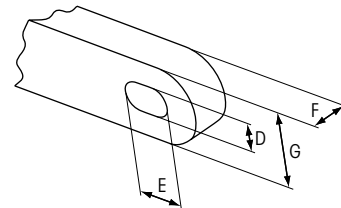
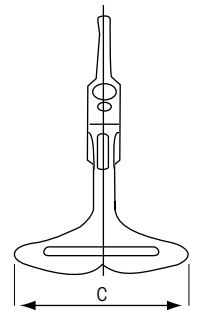
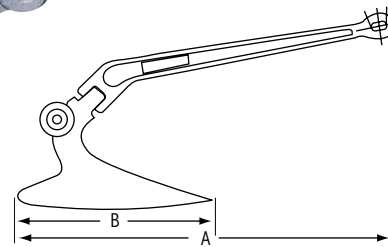

SOC ANCHOR

Plough-type anchor. Available in galvanized cast steel.

Ref.	Boat length	Weight kg	A mm	B mm	C mm	D mm	E mm	F mm	G mm
37846	5,5 m	7 kg	750	400	250	19	19	18	44,5
37847	6,5 m	9 kg	800	410	270	15	15	19	42
37848	9 m	12 kg	930	440	305	16,7	16,7	25,5	51,4
37849	12,5 m	15 kg	970	480	320	17,5	17,5	21	48
37850	17 m	22 kg	1080	670	420	23	23	21,6	55

FOLDING GRAPNEL WITH STRAIGHT FLUKES

Hot-dip galvanized steel.



Ref.	Weight kg	Length mm
P205990	0,7 kg	190 mm
P205991	1,5 kg	330 mm
P205992	2,3 kg	350 mm
P205993	3,5 kg	410 mm
P205994	5,5 kg	470 mm
P205995	7,5 kg	530 mm
P205996	10 kg	620 mm
P205997	12 kg	640 mm

FOLDING GRAPNEL WITH SPOON FLUKES

Hot-dip galvanized steel.



Ref.	Weight kg	Length mm
P205984	1,5 kg	300 mm
P205985	2,5 kg	360 mm
P205986	3,2 kg	410 mm
P205987	4 kg	450 mm
P205988	6 kg	550 mm
P205989	8 kg	570 mm

ROCKFISH GRAPNEL

Galvanized steel.



Ref.	Weight	Length
13255	0,7 kg	360 mm
13256	1,3 kg	435 mm

BOW SHIELDS

316 stainless steel plate. Protects the bow against shocks sustained when the anchor is raised. Fold marks allow installation on any type of bow. The version with hole allows the passage of a towing ring. Fixed by 12 stainless steel screws Ø 4.2 mm (not supplied).

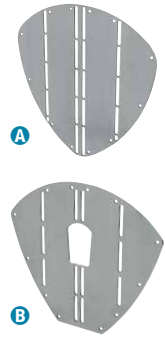

	Ref.	Width	Height	Thickness	Weight
A	58388	350 mm	345 mm	1,5 mm	650 g
B	59040	320 mm	277 mm	1,5 mm	650 g

MUSHROOM ANCHOR

Steel anchor with PVC coating. Ideal for small boats (kayaks, tenders...) for use on mud or fine sand bottoms. Once in place, silt or fine sand enters through the holes in the cup, causing a suction cup effect. Perfectly suited to freshwater use. The anchor's rounded shape prevents damage to the boat's hull.



Ref.	Weight kg	Height mm	Diameter mm	For shackle
67301	3,6 kg	180 mm	160 mm	8 mm
67302	4,5 kg	190 mm	200 mm	8 mm
67303	6,8 kg	240 mm	220 mm	12 mm
67304	9,1 kg	250 mm	240 mm	12 mm

Accessories

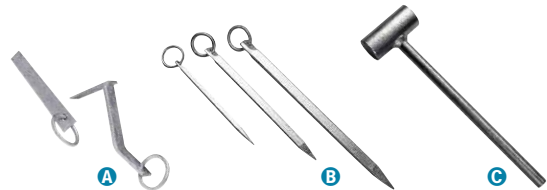

Galvanized steel mooring stakes

	Ref.	Description	Model
A	13967	Anchor spike for rocky seabed	Straight
	13968	Anchor spike for rocky seabed	Cranked
	27505	Picket for loose bottoms	12 x 300 mm
B	27506	Picket for loose bottoms	20 x 425 mm
	27507	Picket for loose bottoms	25 x 550 mm
C	27498	Hammer	



SCREW-TYPE BOLLARDS, 316 STAINLESS STEEL

Ref.	Diameter	Height	Width	Base	Bore diameter	Pitch
51177	50 mm	95 mm	130 mm	92 x 92 mm	6 mm	60 x 60 mm
51178	60 mm	120 mm	160 mm	97 x 122 m	8 mm	65 x 95 mm
51179	70 mm	142 mm	180 mm	118 x 140 mm	8 mm	80 x 105 mm
416146	80 mm	172 mm	200 mm	150 x 120 mm	10 mm	80 x 115 mm

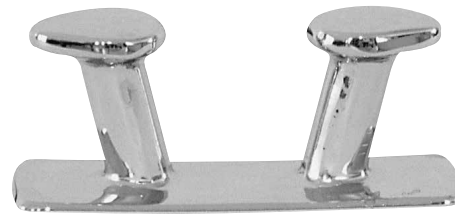

THREADED CHROMED BRASS BOLLARD

Ref.	Diameter	Height	Length	Width	Pitch	Tapping
401489	65 mm	65 mm	170 mm	40 mm	90 mm	M10
418325	85 mm	74 mm	200 mm	65 mm	105 mm	M12
418326	90 mm	87 mm	250 mm	80 mm	135 mm	M14

SAFE ANCHORING

The variety of seabeds and the length of the anchor rode impact the anchor holding power enormously. It is therefore recommended to have systematically 2 anchoring systems, regardless of boat size and regulation.

BOWER AND SECONDARY ANCHOR

Use for example a plough anchor Kobra-type, efficient on 80 % of seabeds, and a flat Britany-type anchor, ideal for soft grounds.

A THIRD ANCHORING RODE

Is also advisable : aluminium anchor with a weighted rope. Easy to handle by the whole crew and ideally suitable for a "lunch-hook", it can also be used as an extra emergency anchor.

SCOPE OF ANCHOR LINE

Should be determined according to the water depth below the keel and the wind conditions :

- less than 10 m : 3 times the water depth, up to Force 3
5 times the water depth, up to Force 6
7 times the water depth, up to Force 9 ;
- more than 10 m : no more than 5 times the water depth ;
- beyond Force 9 : you should set 2 anchors, either each on its own line, or both anchors on the same line.

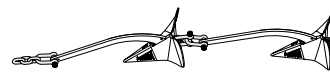
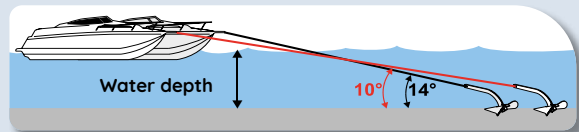

2 anchors connected together



2 anchors on same line, with a 2 to 5 m chain interval

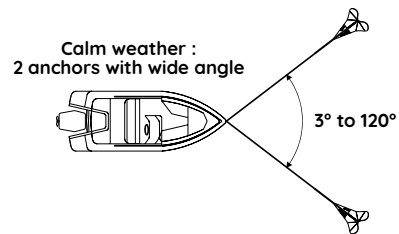

Calm weather :
2 anchors with wide angle

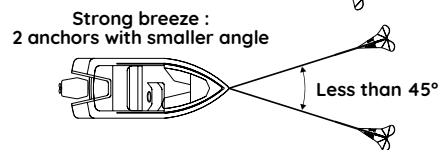

Strong breeze :
2 anchors with smaller angle

INFOS

To help you make the right choice, Plastimo offers all the anchoring essentials in a package consisting of a Brittany, Grip or Kobra anchor, with the appropriate chain, shackles and rope.

PLASTIMO

BRITANY PACKAGE

Ref.	35202	35203	35204	35205	35206	35207	65847
Anchor	Britany 8 kg	Britany 10 kg	Britany 12 kg	Britany 14 kg	Britany 16 kg	Britany 20 kg	Britany 25 kg
Boat length	< 6,5 m	6,5 - 7,5 m	7,5 - 9 m	9 - 10,5 m	10,5 - 2,5 m	12,5 - 16 m	25 m
Boat weight	< 1 T	1 - 2 T	2 - 3 T	3 - 4 T	4 - 8 T	8 - 12 T	< 16 T
Chain diameter	6 mm	8 mm	8 mm	8 mm	10 mm	10 mm	
Chain length	13 m	15 m	18 m	21 m	25 m	32 m	
Rope diameter	10 mm	14 mm	14 mm	14 mm	18 mm	18 mm	
Rope length	20 m	23 m	27 m	32 m	38 m	48 m	
Shackle diameter	8 mm	10 mm	10 mm	10 mm	12 mm	12 mm	
Mooring weight	25 kg	31 kg	52 kg	60 kg	109 kg	140 kg	

KOBRA PACKAGE

Ref.	46564	46566
Anchor	Kobra 4 kg	Kobra 6 kg
Boat length	4 - 6 m	6 - 8 m
Chain diameter	6 mm	6 mm
Chain length	8 m	10 m
Rope diameter	6 mm	8 mm
Rope length	30 m	30 m
Shackle diameter	8 mm	8 mm
Mooring weight	12,2 kg	16,4 kg

GRIP PACKAGE

Ref.	46565	46567
Anchor	Grip 5 kg	Grip 7 kg
Boat length	4 - 6 m	6 - 8 m
Chain diameter	6 mm	6 mm
Chain length	8 m	10 m
Rope diameter	6 mm	8 mm
Rope length	30 m	30 m
Shackle diameter	8 mm	8 mm
Mooring weight	13,5 kg	17,4 kg

MOORING PACKAGE

Composed of a length of chain, a length of rope and a shackle to equip the anchor of your choice. DIN 766A (ref. P201964 to P201968 delivered without shackles)

Ref.	53242	53243	53244	53245	53246
Anchor	< 8 kg	8-10 kg	10-12 kg	12-14 kg	15-20 kg
Boat length	< 6,50 m	6,50 - 7,50 m	7,50 - 9 m	9 - 12 m	12 - 16
Chain diameter	6 mm	6 mm	8 mm	8 mm	10 mm
Chain length	10 m	13 m	15 m	18 m	21 m
Chain diameter	8 mm	12 mm	14 mm	14 mm	18 mm
Rope length	20 m	25 m	25 m	32 m	40 m
Shackle diameter	8 mm	8 mm	10 mm	10 mm	12 mm

CROSSEVEN

P201964	P201965	P201966	P201967	P201968
< 8kg	10-12 kg	12-14 kg	12-14 kg	15-20 kg
6,50 m	7,50 - 9 m	9 - 12 m	9 - 12 m	12 - 16 m
6 mm	8 mm	8 mm	8 mm	10 mm
13 m	15 m	18 m	23 m	28 m
10 mm	14 mm	14 mm	14 mm	18 mm
20 m	25 m	30 m	35 m	40 m



OCTOPLAIT POLYESTER **MADE IN FRANCE**

Very aesthetic, often used on large yachts. High elongation coefficient. Good tensile, abrasion and UV resistance. Very flexible. Easily spliced. Rope color: black.



Ref.	Diameter	Breaking load	Weight/m	Length
51388	10 mm	1 500 kg	75 g	220 m
51391	12 mm	2 000 kg	100 g	220 m
51394	14 mm	2 500 kg	130 g	220 m
51397	16 mm	3 000 kg	180 g	110 m
51400	18 mm	3 900 kg	210 g	110 m
51403	20 mm	4 600 kg	264 g	110 m
51406	24 mm	5 700 kg	320 g	110 m
51409	28 mm	8 400 kg	420 g	110 m



GOOD TO KNOW

Deduct 20-50% of the breaking strength depending on the connections used. It is advisable to make splices whenever possible, and to thimble them if they are in contact with a metal part. To preserve your ropes and keep their mechanical characteristics,

protect them from abrasion and stress by using mooring shock absorbers. For winter storage, the rope should be rinsed with fresh water and dried before storage. A second mooring is required on board to cope with the forecast gales.

DOUBLE BRAIDED POLYESTER

High-strength braided mooring ropes. Available in 16 or 24 spindle versions, these polyester ropes offer great strength and durability for reliable nautical use.

Black	Breaking load	Weight/m	Length	Color		
				White	Black	Navy blue
6 mm	878 kg	30 g	200 m	P201806	P201815	P201824
8 mm	1350 kg	46 g	200 m	P201807	P201816	P201825
10 mm	1941 kg	67 g	200 m	P201808	P201817	P201826
12 mm	3371 kg	119 g	200 m	P201809	P201818	P201827
14 mm	4188 kg	150 g	100 m	P201810	P201819	P201828
16 mm	5108 kg	186 g	100 m	P201811	P201820	P201829
18 mm	7264 kg	266 g	100 m	P201812	P201821	P201830
20 mm	8071 kg	296 g	100 m	P201813	P201822	P201831
24 mm	12757 kg	475 g	100 m	P201814	P201823	P201832



MOORING LINES - 3-STRAND POLYESTER

High-tenacity 3-strand mooring spools. Ideal for mooring, these polyester rope spools offer great strength and durability, suitable for use in nautical environments.

Black	Breaking load	Weight/m	Length	Color		
				Black	Navy blue	White
8 mm	1320 kg	45 g	200 m	P201767	P201780	P201793
10 mm	1900 kg	65 g	200 m	P201768	P201781	P201794
12 mm	2500 kg	115 g	200 m	P201769	P201782	P201795
14 mm	2909 kg	146 g	100 m	P201770	P201783	P201796
16 mm	3262 kg	179 g	100 m	P201771	P201784	P201797
18 mm	3528 kg	256 g	100 m	P201772	P201785	P201798
20 mm	6290 kg	287 g	100 m	P201773	P201786	P201799
22 mm	6467 kg	348 g	100 m	P201774	P201787	P201800
24 mm	8577 kg	452 g	100 m	P201775	P201788	P201801
26 mm	10092 kg	509 g	100 m	P201776	P201789	P201802
28 mm	11000 kg	573 g	100 m	P201777	P201790	P201803
30 mm	15017 kg	692 g	100 m	P201778	P201791	P201804
32 mm	18011 kg	759 g	100 m	P201779	P201792	P201805



MOORING AND ANCHORING LINES

High-tenacity stainless steel thimble 3-strand mooring kit Designed in durable polyester, this kit is ideal for secure mooring thanks to its increased strength. It includes a stainless steel thimble for optimum protection.



Black	Breaking load	Weight/m	Length	Color		
				Black	Navy blue	White
10 mm	2225 kg	66 g	8 m	P201833	P201848	P201863
			12 m	P201834	P201849	P201864
		30 m	P201835	P201850	P201865	
12 mm	2500 kg	118 g	8 m	P201836	P201851	P201866
		117 g	12 m	P201837	P201852	P201867
		116 g	30 m	P201838	P201853	P201868
			40 m	-	-	P201869
14 mm	2908 kg	150 g	8 m	P201839	P201854	P201870
		148 g	12 m	P201840	P201855	P201871
		147 g	30 m	P201841	P201856	P201872
			50 m	-	-	P201873
		183 g	8 m	P201842	P201857	P201874
16 mm	3262 kg	182 g	12 m	P201843	P201858	P201875
		180 g	30 m	P201844	P201859	P201876
		262 g	8 m	P201845	P201860	P201877
		260 g	12 m	P201846	P201861	P201878
18 mm	3528 kg	258 g	30 m	P201847	P201862	P201879



BRAIDED POLYESTER MOORING ROPE WITH SPLICED EYE

16-spindle double-braided polyester mooring kit offers optimum strength and is equipped with a spliced eye for reliable and convenient mooring.

- With spliced eye.
- Polyester.
- Available in 3 colors: black, navy blue and white.
- Individually packaged in mesh bags.
- 6 different diameters: 10 mm / 12 mm / 14 mm / 16 mm / 16 mm / 20 mm / 24 mm.
- 6 different lengths: 6 m / 7 m / 9 m / 11 m / 12 m / 15 m.

Black	Breaking load	Weight/m	Length	Color		
				Black	Navy blue	White
10 mm	2200 kg	74 g	6 m	P201880	P201886	P201892
12 mm	3500 kg	129 g	7 m	P201881	P201887	P201893
14 mm	3850 kg	160 g	9 m	P201882	P201888	P201894
16 mm	6100 kg	196 g	11 m	P201883	P201889	P201895
20 mm	9550 kg	315 g	12 m	P201884	P201890	P201896
24 mm	14000 kg	494 g	15 m	P201885	P201891	P201897



POLYESTER MOORING LINE WITH STAINLESS STEEL THIMBLE SPLICE

Mooring kit in 16-strand double-braided polyester, offers optimum strength and is equipped with a spliced eye on thimble for reliable and convenient mooring.

- With a spliced eye on stainless thimble.
- Polyester.
- Available in 3 colors: black, navy blue and white.
- Individually packaged in mesh bags.
- 6 different diameters: 10 mm / 12 mm / 14 mm / 16 mm / 20 mm / 24 mm.
- 6 different lengths: 6 m / 7 m / 9 m / 11 m / 12 m / 15 m.

Black	Breaking load	Weight/m	Length	Color		
				Black	Navy blue	White
10 mm	1962 kg	69 g	6 m	P201898	P201904	P201910
12 mm	2647 kg	122 g	7 m	P201899	P201905	P201911
14 mm	3850 kg	153 g	9 m	P201900	P201906	P201912
16 mm	6100 kg	189 g	11 m	P201901	P201907	P201913
20 mm	9550 kg	305 g	12 m	P201902	P201908	P201914
24 mm	14000 kg	481 g	15 m	P201903	P201909	P201915





PLASTIMO

happy boating to you!



Discover our fenders



PERFORMANCE FENDERS

A RANGE OF FENDERS COMBINING MANUFACTURING PRECISION AND GUARANTEED STRENGTH

INFOS

Thanks to the indications on the fender, you can check the ideal pressure at any time, either with a pressure gauge or by measuring the circumference of the fender.

PLASTIMO**TWO-COLOUR INFLATED PERFORMANCE FENDER**

Same technical features as the Performance fenders, in a two-tone version: fender body white, black cones. Use horizontally or vertically.

Optimal shock absorption regardless of the point of impact on the fender, thanks to perfect distribution of the PVC over the entire fender. Delivered with rope.

Ref.	Boat length max.	Diameter	Length	Eye diameter	Overall diameter
63902	6 m	10 cm	40 cm	1,3 cm	10,5 cm
63903	8 m	13 cm	50 cm	1,6 cm	14 cm
63904	10 m	15 cm	60 cm	2 cm	15,9 cm
63905	12 m	20 cm	80 cm	2,7 cm	21,3 cm
63906	12 m	21 cm	62 cm	2,7 cm	22,9 cm
63907	14 m	23 cm	85 cm	2,8 cm	24,8 cm
65488	Monohull 16 m+ / Catamaran 14 m+	30 cm	110 cm	2,8 cm	32 cm

**PERFORMANCE TWO-TONE FENDER - UNINFLATED**

Ref.	Boat length max.	Diameter	Length	Eye diameter	Overall diameter
63908	6 m	10 cm	40 cm	1,3 cm	10,5 cm
63910	10 m	15 cm	60 cm	2 cm	15,9 cm
63911	12 m	20 cm	80 cm	2,7 cm	21,3 cm
63912	12 m	21 cm	62 cm	2,7 cm	22,9 cm
63913	14 m	23 cm	85 cm	2,8 cm	24,8 cm
65492	Monohull 16 m+ / Catamaran 14 m+	30 cm	110 cm	2,8 cm	32 cm
63909	8 m	13 cm	50 cm	1,6 cm	14 cm

SPARE VALVE

Black valve cap Injected polyethylene valve.

- Replaces in seconds.
 - Eliminates any risk of corrosion.
 - Equipped with a protective cap.
- For Performance fenders and Bumper. Supplied in packs of 6.

Ref.	Color
63935	Black
63936	White

**ADAPTER FOR PLASTIMO VALVE**

Ref. 56860

Injected polyethylene valve.

- Replaces in seconds.
- Eliminates any risk of corrosion.
- Equipped with a protective cap.

For inflating Performance fenders and Bumper. Compatible with all our inflators. Supplied in packs of 10 units.

**FENDER FOR LARGE YACHTS**

White, UV-resistant PVC. Durable brass valve.

Ref.	Boat length max.	Diameter	Length	Eye diameter
39622	15 m	35 cm	110 cm	3 cm
39623	18 m	45 cm	140 cm	3 cm

**PLASTIMO****Options and accessories** 

Brass adapt valv arc/multi/ladder fender
67111

Screw onto the valve: allows use of an inflator or bicycle pump.

Adaptable to models: Spherical fenders, Parabor models, single-ring fenders (ref. 39624 & ref. 39625), models Page 193 of our catalog, ARC models (ref. 65560, ref. 65561, ref. 65562), and scale fenders Page 197.

MADE BY **PLASTIMO**



ARTICULATED RIB FENDER

Original system devised by the Plastimo Design Office, particularly suited to RIBs or boats with very rounded shapes. While a traditional fender pulls away from the float and can end up slipping off, the articulated fender hugs the shape of the boat perfectly and remains in the ideal position to provide protection. Made from rotomolded, UV-resistant PVC, in white, blue or black. Delivered with 1 m of 5 mm diameter rope. Patent no. B63B59/00

Diameter	Lenght	Color		
		Blanc	Blue	Black
12 cm	48 cm	66345	66346	66428
15 cm	60 cm	66780	66876	66875



PLASTIMO

ARC FENDER

Purposeful PVC fender, black end caps. Protects the hull and can be used as a step for easy on-board access. Dimensions: 54 x 43 x 20 cm. Weight: 1.8 kg.

	Ref.	Color
A	65560	White
B	65561	Navy blue
C	65562	Black



INFOS

Black cover in high-abrasion polyester with polyurethane coating.

- Stitched straps along the length of the frog for increased tear resistance.
- Stitched straps at the bottom of the cover allow the fender to be used horizontally.

Black heat-sealed PVC air chamber (thickness 0.9 mm), Halkey Roberts valve. Recommended pressure: 0.25 bar (3.50 PSI).



SINGLE INFLATABLE FENDER

Space-saving and effective protection. Delivered with 2 m of 10 mm diameter end.

Ref.	Diameter	Lenght	Weight
65493	25 cm	50 cm	0,950 kg
65494	30 cm	75 cm	1,390 kg
65495	35 cm	100 cm	2,080 kg
65496	40 cm	120 cm	2,800 kg
65497	50 cm	150 cm	4,050 kg



DOUBLE INFLATABLE FENDER

Two fenders slipped into a cover. For large units or foil boats. Large microfiber patch on the hull side to avoid any marks on the boat. Large area provided for marking the fenders.

Ref.	Width	Fender diameter	Lenght	Width
66118	60 cm	30 cm	75 cm	3,14 kg
66120	100 cm	50 cm	80 cm	5,56 kg

Options & accessoires

Spare cover
Replacement cover for single inflatable fender in high-abrasion-resistant black polyester, polyurethane coating.

Ref.	For fender
66906	65493
66907	65493
66908	65495
66909	65496
66910	66910

Options and accessories



Foot pump 4 L
57713



	Ref.	Capacity	Max pressure	Dimensions
A	57713	4 L	500 mbar - 7,2 psi	28 x 21 x H 6 cm
B	10157	5 L	600 mbar - 8,7 psi	29 x 21 x H 8 cm
C	36900	Replacement nozzle		



FLEECE-COVERED FLAT FENDER

- Ideal for wedging between two side-by-side boats, this fender also offers effective protection at pontoons or quayside.
- Closed-cell polyethylene foam with white PVC outer shell, one side fleece-lined to preserve the hull.
- Useable horizontally or vertically.
- Superposable, the two fenders are easily assembled using a lacing cord (not supplied).
- Detachable and washable, they are easy to care for.
- Fleece fiber adds comfort when the fender is used as a cushion or die back.

Ref.	Thickness	Width	Lenght
56922	10 cm	20 cm	60 cm
56923	10 cm	40 cm	60 cm



FLAT FENDER

- Flat fender made of high-density closed-cell foam board offering excellent pressure resistance.
- Use in vertical or horizontal position.
 - Foam covered by a waterproof nylon/PVC fabric cover with zipper. Navy color.
 - Easy to remove and clean.
 - Delivered with rope.
 - Can also be used as a cushion or die back.

Ref.	Thickness	Width	Lenght	Rope
62298	6 cm	25 cm	30 cm	2,10 m
62299	12 cm	30 cm	40 cm	2,60 m
62300	12 cm	40 cm	50 cm	3 m



FLAT TYPE FENDER

- Semi-rigid fenders: no risk of deflation.
 - Made from closed-cell polyethylene foam, they effectively protect the hull.
 - Do not absorb water and repel hydrocarbons.
 - Easy to stack in a trunk.
 - Do not mark the hull.
 - Easy to clean.
- Can also be used as a cushion for sitting or kneeling.

Lenght	Width	Thickness	Color	
			Blue	Grey
49 cm	19 cm	5 cm	14518	64402
65 cm	24 cm	8 cm	64401	64403
96 cm	31 cm	8 cm	14520	64404



LONG FENDER SOCKS

- Covers for single and double fender thickness.
- 100% acrylic, UVBS8 treated
- High strength and flexibility
- These covers are made from 100% acrylic material, offering high strength and flexibility. They are highly UV-resistant and made from a non-abrasive, stain-resistant acrylic fabric and loop knit that is both durable and fade-resistant (tested to British Standard EN ISO105-B02 Grade 7 for UV light resistance).

To preserve their appearance, simply hand wash with cold water and a small amount of detergent if necessary.

Designed to fit Plastimo, Majoni and Polyform beater guards.

- Single thickness: Supplied in pairs
- Double thickness: Supplied individually

Model	For Diameter	Lenght	Thickness	Color			
				Black	Beige	Navy blue	Grey
F01M	12 - 15 cm	40 - 50 cm	Simple	P205554	P205577	P205600	-
F02	18 - 20 cm	60 - 66 cm	Simple	P205555	P205578	P205601	-
F1	12 - 15 cm	58 - 61	Simple	P205556	P205579	P205602	P205625
F2	21 - 23 cm	61 - 62 cm	Simple	P205557	P205580	P205603	P205626
F3	20 - 24 cm	70 - 80 cm	Simple	P205558	P205581	P205604	P205627
F4	22 cm	104 cm	Simple	P205559	P205582	P205605	P205628
			Double	P205568	P205591	P205614	P205637
F5	23 - 30 cm	78 - 90 cm	Simple	P205560	P205583	P205606	P205629
			Double	P205569	P205592	P205615	P205638
F6	29 cm	109 cm	Simple	P205561	P205584	P205607	P205630
			Double	P205570	P205593	P205616	-
F7	38 cm	102 cm	Simple	P205562	P205585	P205608	P205631
			Double	P205571	P205594	P205617	-



SPHERICAL FENDER SOCKS

Model	For Diameter	Lenght	Thickness	Color		
				Black	Navy blue	Grey
A1	29 - 30 cm	37 - 38 cm	Simple	P205563	P205609	P205632
			Double	-	P205618	-
A2	35 - 39 cm	48 - 50 cm	Simple	P205564	P205610	P205633
			Double	-	P205619	-
A3	45 - 47 cm	58 - 62 cm	Simple	P205565	P205611	P205634
			Double	-	P205620	P205643
A4	55 cm	71 - 73 cm	Simple	P205566	P205612	P205635
			Double	-	P205621	P205644
A5	65 - 71 cm	88 - 94 cm	Simple	P205567	P205613	P205636
			Double	-	P205622	P205645



SELECTED BY PLASTIMO

FENDER SOCK, ONE SIZE FITS ALL

Ref. 24733

Polyamide sock. Adaptable to nearly any size and type of fender in our range, thanks to its continuous tubular fabric of great elasticity and strength.

- Supplied in 5-meter lengths, with 12 plastic clamps.
- Suitable for 6 fenders from Ø10 to 25 cm.



STANDARD ONE-FENDER MODEL

Delivered complete with clamp, screws and 316 L stainless steel wire support.

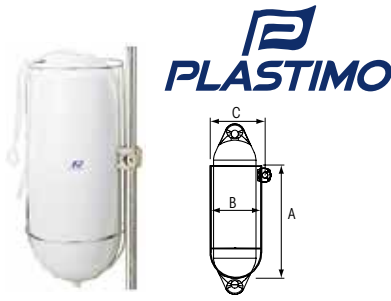

Ref.	Fender diameter	A	B	C
36189	200 mm	455 mm	205 mm	235 mm
36190	230 mm	558 mm	235 mm	265 mm
36191	250 mm	475 mm	255 mm	285 mm

STANDARD 3-FENDER MODEL

Delivered complete with clamp, screws and bracket in 316 L stainless steel wire.

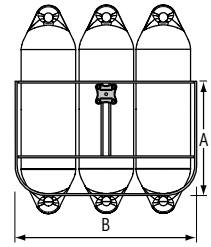

Ref.	Fender Diameter	A	B
36207	150 mm	310 mm	460 mm
36209	200 mm	455 mm	610 mm

UNIVERSAL HOLDER

Unique system: the height-adjustable clamp is equipped with spring-mounted 136 L stainless steel rings that hold the fender in place at each end. Once the fender is removed, the rings fold down completely; the deck is clear and movement is facilitated. Designed for vertical attachment (e.g. chandelier, balcony) or horizontal attachment (front balcony). Patented model.

Ref.	Fender Diameter	A
36203	90 - 200 mm	180 mm

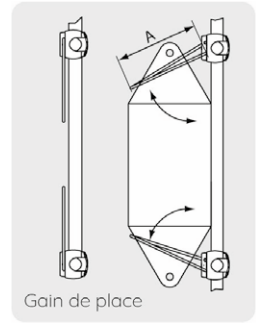

DOCK PROTECTIONS

Composed of 100% closed-cell foam, Bacell® offers excellent puncture resistance and optimal shock absorption. These protective elements leave no marks on the boat and are UV-treated. Accessories included: 4 plastic mounting plates + stainless steel screws.

Ref.	Model	Length	Width	Thickness
A 57406	Marina Fender	1000 mm	140 mm	60 mm
B 57407	Fender List	940 mm	85 mm	44 mm

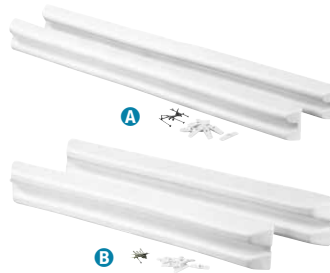

Le Marina Fender et le liston de protection Fender List peuvent être découpés et courbés pour épouser plus facilement les contours du ponton.

SELECTED BY PLASTIMO

DOCK FENDER 500 X 120 MM

Ref. 16339



Specifically designed for mounting on a flat surface. Fixing by 8 Ø 7 mm screws (not supplied).

SELECTED BY PLASTIMO

RUBBER DOCK FENDER

Ref. 13710

White rubber.
• Dimensions: 30 x 10 x 4 cm.



SELECTED BY PLASTIMO

ANGLE DOCK FENDER

Ref. 16340

Foldable to an angle of 90°. Fixed by 8 Ø 7 mm screws (not supplied). Unfolded length: 490 mm.

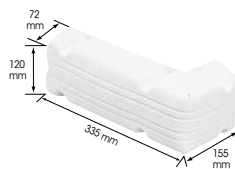

DOCKWHEEL

Ref. 66437

Effectively protects your boat from bumps on pontoon corners. Aid for docking. PVC wheel diameter 30 cm, width 15 cm, mounted on plastic support. Support size: L: 17,5 cm x H: 8 cm



INFOS

Whether you're sailing solo or with a crew, whether you're a beginner or an experienced skipper, the Bumper® will save you a few scares when you arrive at the pontoon, especially in high winds or strong currents! The Bumper® is a real bumper to be fixed to the pontoon; depending on its location, it will protect

the bow or the side of the boat. Useable on all types of pontoon and purlin: right-angled, or rounded. Made from rotomolded PVC, 150 mm thick on the impact area. UV-protected. Maximum pressure: 0.10 bar / 1.45 psi. Registered model.

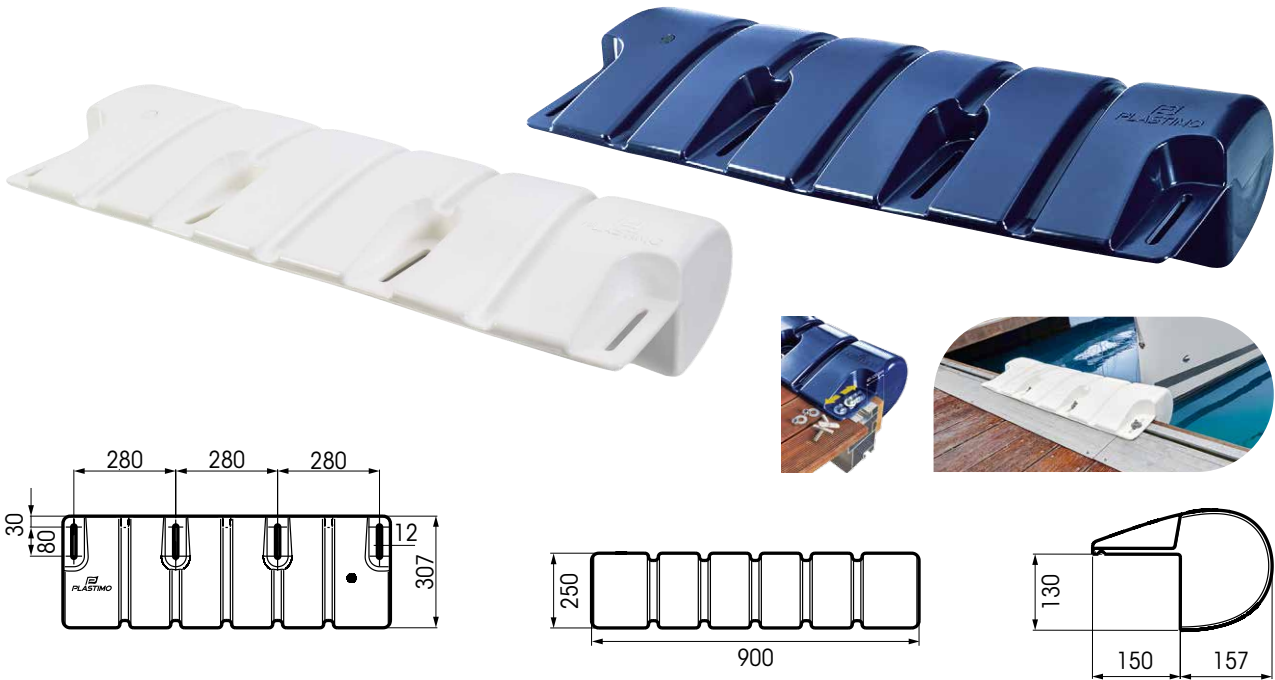

BUMPER, NO-DRILL UNIVERSAL MOUNT

Unique, patented fastening system.

- Useable on all types of pontoon and purlin thanks to its no-drill system: the bolt head locks into the groove.
- Made from rotomolded PVC, 150 mm thick in the impact area.
- UV-protected. Fixing kit not included, to be ordered separately.
- Patent no. 17-50436
- Adaptable to all pontoons with the possibility of adjustment from 40 to 120 mm from the edge of the pontoon.

- Dimensions: Ø 307 x 900 mm.
- Fixing kit not included, to be ordered separately.
- Adaptable to all pontoons with the possibility of adjusting from 40 to 120 mm from the pontoon edge.
- Most marinas prohibit boaters from drilling into pontoons. The foamed Bumper® is ideal for boats over 9 m and is also recommended for high-traffic areas such as the technical pontoon (fuel and water supply ...)

Ref.	Model	Color
65690	3/4 foam Bumper® universal fastener	White
65928	3/4 foam Bumper® universal fastener	Blue
65929	3/4 foam Bumper® universal fastener	Grey
66365	Bumper® 3/4 universal mount foam-filled	White

SPARE VALVE



Black valve cap Injected polyethylene valve.

- Replaces in seconds.
 - Eliminates any risk of corrosion.
 - Equipped with a protective cap.
- For Performance fenders and Bumper. Supplied in packs of 6.

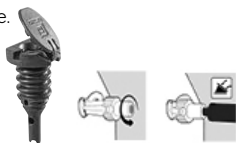

Ref.	Color
63935	Black
63936	White

ADAPTER FOR PLASTIMO VALVE

Ref. 56860



Injected polyethylene valve.

- Replaces in seconds.
 - Eliminates any risk of corrosion.
 - Equipped with a protective cap.
- For inflating Performance fenders and Bumper. Compatible with all our inflators. Supplied in packs of 10 units.

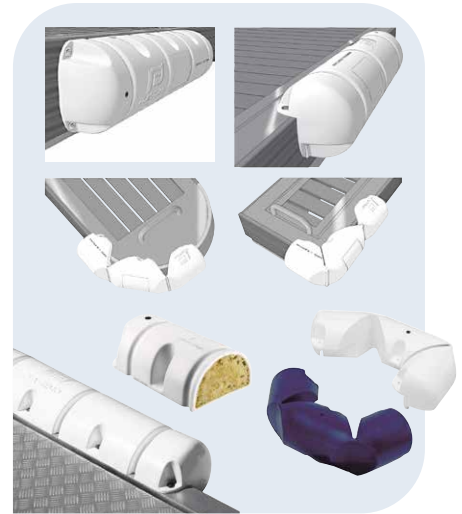

BUMPER, STANDARD MOUNT

The foamed Bumper® is ideal for boats over 9 m and is also recommended for high-traffic areas such as technical pontoons (fuel and water supply, etc.).

Model	Dimensions	Color		
		White	Blue	Grey
Bumper® 3/4 standard	Ø 180 x 400 mm	38082	39357	66401
	Ø 250 x 900 mm	30102	37781	36856
Bumper® 3/4 standard foam mounting	Ø 250 x 900 mm	37783	-	-
Bumper® 1/2 standard	Ø 180 x 400 mm	38558	39358	66399
	Ø 250 x 900 mm	38068	39356	51025
Bumper® 1/2 fixation standard	Ø 250 x 900 mm	39362	-	-
Articulated standard Bumper®	Ø 180 x 800 mm	39146	39359	-



DOCKING POLE

Ref. 29640

Whether you're casting off mooring lines or retrieving them when docking, the mooring-rope-carrying pole allows you to operate in complete safety: the ends are within easy reach, without having to jump onto the quay or pontoon.

Extremely strong, aluminum pole mounted on a large stainless steel spring which allows you to grip the pole without risk of breaking it Height 1.10 m.

Options and accessories

Fixing kit for bumper

64014

Fixing kit To fix the Bumper® in the aluminum groove of the pontoon: 1 T-bolt, 1 lock nut and 1 extra-large washer. Two to three kits required per Bumper.



	Ref.	Model
A	64014	1 fixing kit
A	65843	4 fixing kit

St. steel bolting kit x 4 for bumpers **65843**

Options and accessories

Kit of fastening clamps **36663**

Some ports do not allow screw/bolt fastening. In this case, you will fasten your Bumper® using the clamp kit (except for the articulated model).





REGATTA MARK BUOYS

Inflatable buoys made of UV-resistant yellow PVC 1100 Dacitex, requiring no special care. Equipped with 3 carrying handles, 3 anchoring points and a quick-deflation valve. Equipped with transparent pocket(s) 69 x 60 cm allowing the introduction of graphics or logos. The buoy must not be weighted under any circumstances, as its principle is to move freely on the water without offering any resistance.

- Delivered with repair kit: 1 tube of glue and 1 piece of PVC.
- Replacement valve: ref. 50881

	Ref.	Model	Color	Diameter	Height
A	P201636	Spherical	Yellow	1,50 m	1,60 m
B	P201637	Spherical	Orange	1,50 m	1,60 m
C	P201638	Cylindrical	Yellow	0,90 m	1,50 m
D	P201644	Triangular	Yellow	-	1,50 m
E	P201645	Triangular	Orange	-	1,50 m
F	P201646	Triangular	Green	-	1,50 m





BUOY FOR REGATTA TRAINING

Lightweight, extremely easy to set up and use. Gets wet and up in no time at all.

- Quick inflation and deflation: buoy equipped with a Halkey Roberts-type 1/4-turn valve allowing the use of most inflators.
- Easy to hoist aboard thanks to its numerous handles.
- Easy to transport: takes up very little space when folded. Delivered in a storage bag.
- PVC 1100 Decitex: robustness and rigidity.
- Drifts little under the action of the wind, and holds vertically thanks to the ballast and a large submerged part (52 cm).
- Spare valve: ref.50881.

Ballast buoy

The pocket with removable bag and hook-and-loop fastener holds a ballast of approx. 14 kg (recommended weight for larger models (ref. 38076, ref. P201639 and ref. P201640, to be made with pebbles, cobbles, etc.). This pocket can also be used to store excess mooring line, thus avoiding any risk of snagging in the rudder or daggerboard as the buoy passes. Bottom handle for mooring.

Ref.	Height	Diameter	Color
38076	1,88 m	26 cm	Yellow
P201639	1,88 m	26 cm	Orange
P201640	1,88 m	26 cm	Green
P201641	1,30 m	15 cm	Yellow
P201642	1,30 m	15 cm	Orange
P201643	1,30 m	15 cm	Green



Ballast buoy



Poignée du fond pour amarrer le mouillage.

JUMBO REGATTA MARK BUOY

Ref. 40266

The Jumbo regatta buoy, designed for large yachts, is easy to spot even on very long courses thanks to its 3.20 m height. Made from 1100 decitex PVC, it is perfectly resistant to handling, and to possible collisions during regattas. The three reinforced attachment points, located under its base, allow it to be weighted according to sea and wind conditions.

- 5 handles spread across the structure facilitate handling.
- 3 60 cm x 90 cm pockets for logo or advertising.
- 2 rings at the top for attaching a flag.
- Deflated, its footprint remains minimal.
- Folded dimensions: 1 m x 40 cm x 20 cm.
- Inflated dimensions: length of triangular base 2 m; Ø of cylinder at top 60 cm.
- Weight: 16 kg.
- Inflation: 20 min. with electric inflator. Halkey Roberts type 1/4-turn valves allowing use of most inflators.
- Reinforced attachments.
- Flap attachment rings.
- 5 handling handles.



valve: ref. 50881.



Repair kit : ref. 24816.Spare



5 handling handles.

LADDERS

PLASTIMO

Boarding ladders are often associated to comfort and fun but they remain first and foremost a safety element on board (EN ISO 15085 standard, July 2003). Therefore Plastimo has chosen to further improve the comfort and sturdiness of its ladders.



J. Keagopian

Provides unparalleled comfort and safety.

The width and depth of the anti-slip steps enable you to keep your feet always flat on the step, thus feeling safe and steady. The material and smooth shape of the steps are soft to bare-feet, adding to your comfort. Withstands the harsh marine environment. The use of materials with a proven record of reliability such as 316L stainless steel, polypropylene guarantees the durability and the performance of the ladder. In our Brittany-based factory, all our products are tested in a seawater fog laboratory, where the product undergoes accelerated ageing to reproduce the extremely harsh marine environment.

Two concepts have been developed by our R&D department :

- The exclusive assembly process which allows the steps to keep horizontal, whatever the shape and inclination of the free-board, transom or skirt, simply with an allen key.
- The specific design of the steps, slightly curved and rounded also deep and wide, helps keep your feet away from the free-board and increases the rigidity of the ladder to make boarding safer and easier

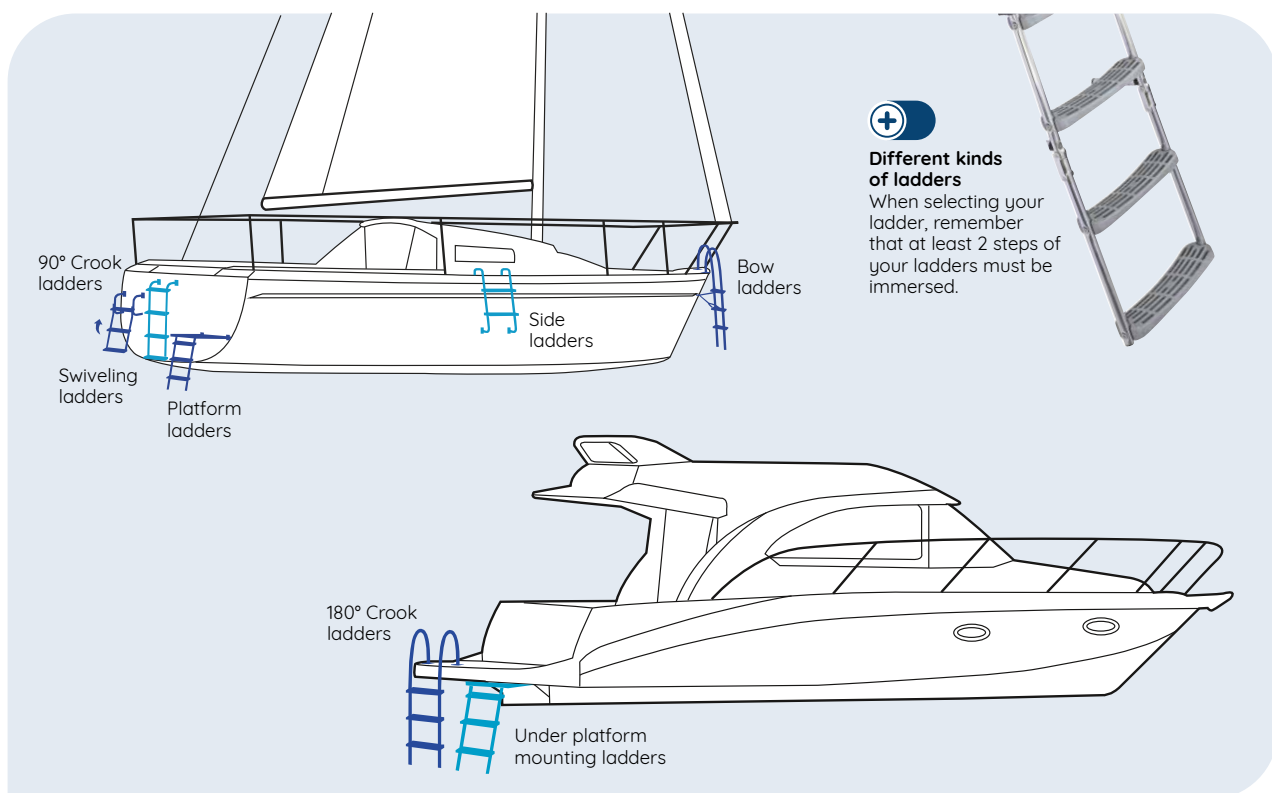

FOLDING LADDER 180° CROOK

- High hooks for easy boarding.
- Inox 316 L
- Removable ladder:
- Add plates ref. 27073 and the ladder becomes removable

Ref.	A	B	Number of steps
55695	1050 mm	405 mm	2 fixed + 2 mobile
55696	1300 mm	655 mm	2 fixed + 3 mobile
55697	1300 mm	405 mm	3 fixed + 2 mobile
55698	1550 mm	655 mm	3 fixed + 3 mobile
30535	1050 mm	405 mm	2 fixed + 2 mobile
65958	2120 mm	370 mm	3 fixed + 3 mobile



LADDER 180° FOR NARROW TRANSOM, 2+2

Ref. 30535

2 fixed + 2 mobile rungs

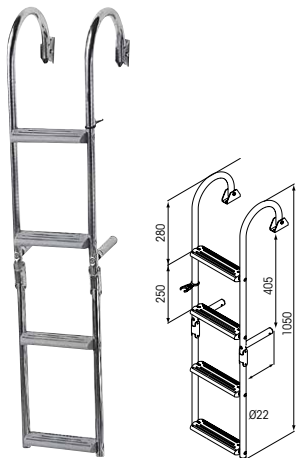

TELESCOPIC FOLDING LADDER

Ref. 65958

6 rungs. High grips for easy boarding.

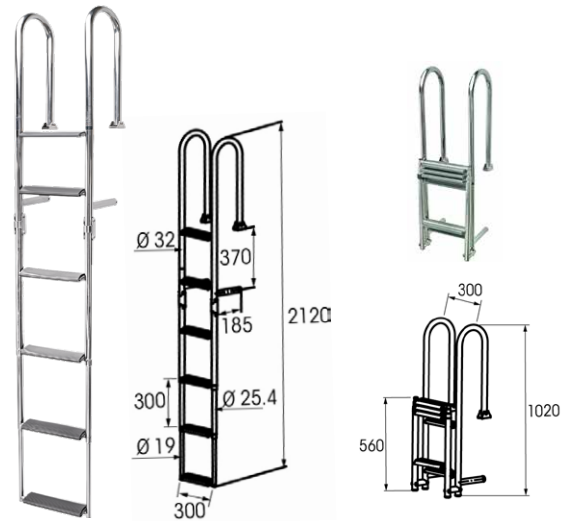

FOLDING ST. STEEL LADDER 90° CROOK

- Inox 316L.
- Add plates ref. 27073 and the ladder becomes removable

Ref.	A	B	Material	Number of steps
55699	785 mm	300 mm	Stainless steel	1 fixed + 2 mobile
55700	835 mm	370 mm	Stainless steel	2 fixed + 2 mobile
55701	1085 mm	620 mm	Stainless steel	2 fixed + 3 mobile
55702	1085 mm	370 mm	Stainless steel	3 fixed + 2 mobile
55703	1335 mm	620 mm	Stainless steel	3 fixed + 3 mobile
30536	835 mm	370 mm	Inox 316L	2 fixes + 2 mobiles

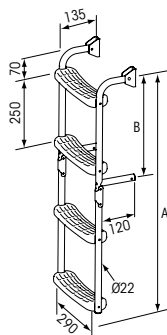

LADDER 90° FOR NARROW TRANSOM, 2+2

Ref. 30536

2 fixed + 2 mobile rungs

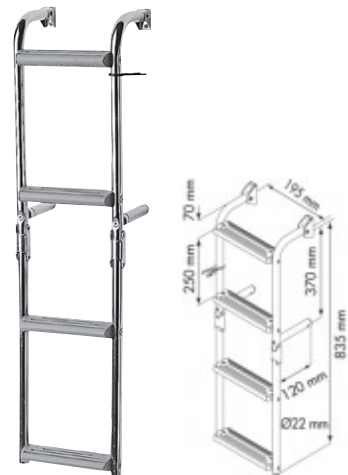

SKIRT AND PLATFORM LADDER

Ref. 55694

Thanks to the exclusive steps, the same ladder can be used alternately for bathing and for access to the boat from the pontoon.

- 1 fixed rung + 3 mobile

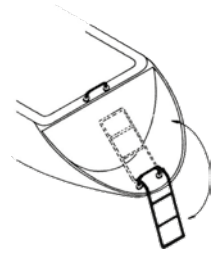
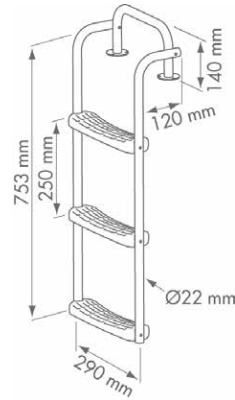

TILT-UP TELESCOPIC LADDER FOR TRANSOM

Ref. 65957

4 steps

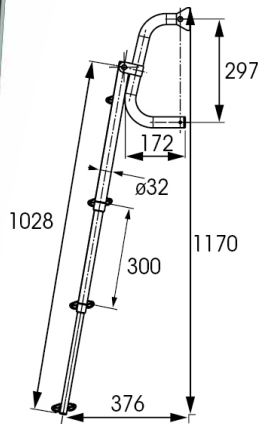
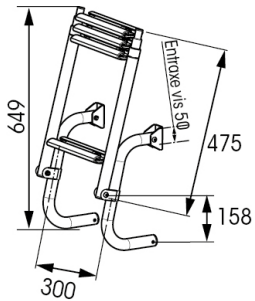

LADDER FOR NARROW TRANSOM

Ref. 29398

3 grey plastic rungs.
316L stainless steel tube.
Handrail-type fixed part.

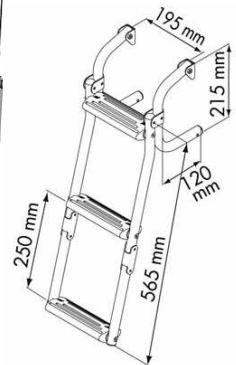

TELESCOPIC LADDER

Platform assembly.

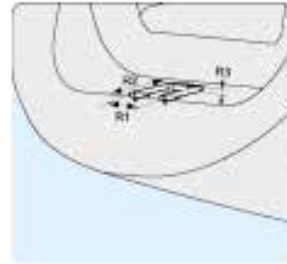
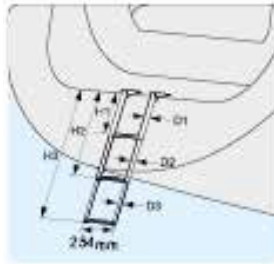

Ref.	Model	H1	H2	H3	D1	D2	D3	R1	R2	R3
48682	Swivelling 3 steps	250 mm	505 mm	790 mm	31,8 mm	25,4 mm	19 mm	305 mm	365 mm	40 mm

ABOVE PLATFORM MOUNTING TELESCOPIC LADDER, TEAK STEPS

Ref. 66531

4 rungs. Large handles for easy boarding.



ABOVE PLATFORM MOUNTING TELESCOPIC DIVE LADDER

Ref. 66553

4 rungs. Specifically designed for scuba diving: non-slip "parrot" steps suitable for boarding by a person wearing flippers.

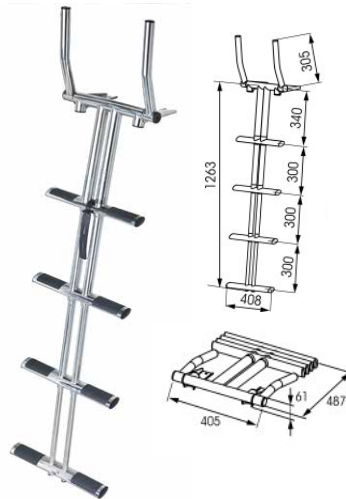

TELESCOPIC LADDER, PVC STEPS

Ref. 66344

3 rungs. Slip-resistant grey PVC steps, 70 mm wide for better stability. Ergonomic shape, comfortable even in bare feet. Exclusive Plastimo design with integrated shock absorber system.

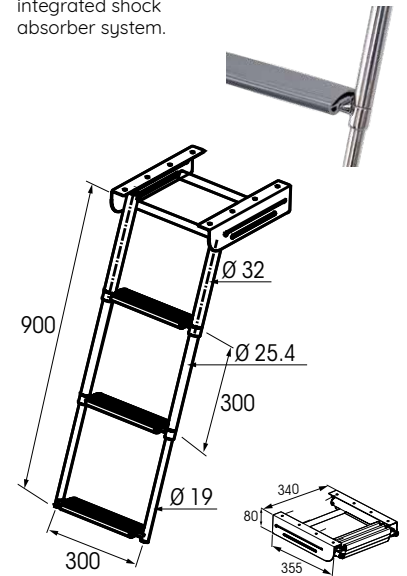

TELESCOPIC LADDER FOR PLATFORM

Stainless steel telescopic ladder (316L).
Under-platform mounting.

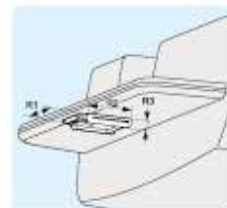

Ref.	Model	H1	H2	H3	H4	D1	D2	D3	D4	R1	R2	R3
48684	Fold-away 3 steps	290 mm	580 mm	860 mm	-	31,8 mm	25,4 mm	19 mm	-	295 mm	300 mm	66 mm
57036	Fold-away 4 steps	290 mm	580 mm	860 mm	1150 mm	38,5 mm	31,8 mm	25,4 mm	19 mm	303 mm	318 mm	78 mm



PLATFORM & TELESCOPIC LADDER

Ref. 65959

3 rungs. Slip-resistant gray PVC steps, 70 mm wide for greater stability. Ergonomic shape, comfortable even in bare feet. Exclusive Plastimo design with integrated shock-absorbing system.

SELECTED BY PLASTIMO



TELESCOPIC LADDER, PVC PLATFORM

Ref. 29390

Stainless steel ladder, designed for all types of boats. Guarantees comfort and stability thanks to its platform and wide, non-slip steps.

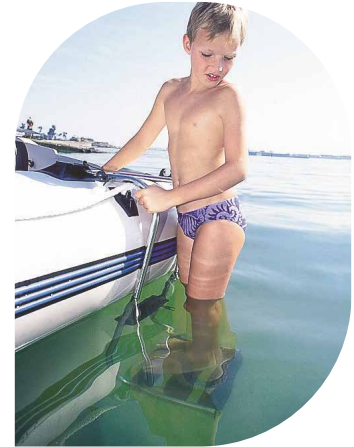

IMMERSED PLATFORM LADDER

Ref. 29181

- Designed for all types of dinghies from 3 to 6 metres, semi-rigid or full-bottom.
- Featuring stainless steel uprights and a mini submerged platform for kneeling and disposing of heavy or bulky equipment (diving block, fins, shotgun).
- The diver then has easy access to the board.
- Ideal also for climbing back aboard after swimming.

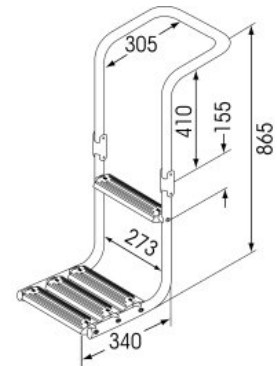

ST. STEEL LADDER

Ref. 29392

- 3 rungs: supplied with two plates allowing the ladder to be attached to and removed from the bow instantly.
- Exclusive Plastimo: steps with adjustable horizontality.
- Bow ladder, width 195 mm, 180° brackets.
- Shape designed to perfectly fit the boat's bow.
- Stainless steel 316 L structure + 3 gray plastic steps.
- Stainless steel 316 L.

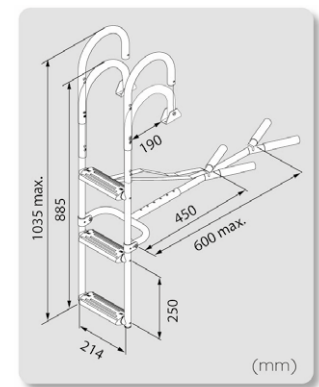

Options and accessories

Two-in-one system 66581
two-in-one crutch to convert bow ladder: ref. 29392 into accommodation ladder.



BOARDING LADDER

Quickly installed, it allows easy boarding.
Pad for anti-theft system.
2 rungs.

Ref.	A	B
55705	90 mm	485 mm
55706	245 mm	630 mm

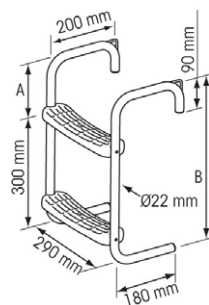

BOARDING LADDER

Fold-down, non-slip plastic-coated handles. Aluminum tube diameter 25 mm. Plastic steps, width 355 mm, depth 70 mm. Height between steps: 255 mm. Handle width (L): 260 mm.



Ref.	Model	Total height
35911	2 steps	650 mm
35912	3 steps	930 mm
35913	4 steps	1210 mm



COLLAPSIBLE BOARDING LADDER

Plastic steps, width 295 mm. Assembled on synthetic rope, protected in plastic tubes that stiffen the uprights between the steps. Height between steps: 200 mm. Easy folding, the steps interlock for a reduced footprint. Nonslip steps.

Ref.	Model
62149	3 steps
62150	4 steps

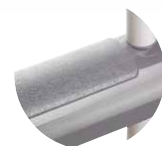

FASTENINGS

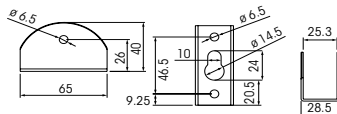

	Ref.	Designation	Diameter
A	413569	Stainless steel U-bolts.	Ø 25 cm
B	408233	Fixings (x2) inox.	Ø 25 mm
C	416898	Stainless steel tube knob.	Ø int. 22 mm

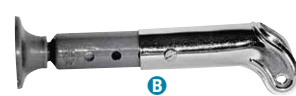
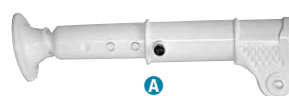

STAND-OFFS

Length: 145 / 215 mm. Diameter: 25 mm. Delivered in pairs.

	Ref.	Color
A	414158	White
B	414159	Grey



LADDER STEPS

Plastic honeycomb step.
For 25 mm diameter tube.

	Ref.	Dimensions	Center distance	Type of fasteners
A	409684	265 x 68 mm	257 mm	screw Ø 5,5 x 38 TCL (not supplied)
B	409645	370 x 70 mm	345 mm	Integrated rivet



ARTICULATION FOR LADDER, ST.S Ø 25 MM

Ref. 408234

Stainless steel articulation.
Adjustable Ø 25 mm steps.

ACCESSORIES FOR PLASTIMO LADDERS

GOOD TO KNOW

Adjustable steps : customise and adjust the steps inclination to match the transom angle

Unique step-adjusting concept, designed by our Research & Development department. This exclusive assembly process allows to keep the steps horizontal, whatever the shape and inclination of the free-board, transom or skirt. You just need to add a step inclination kit that fits between the st. steel tube and the actual step.

Simply adjust the inclination of the steps with an allen key, which enables you to convert a "series" ladder into a "customised" ladder.

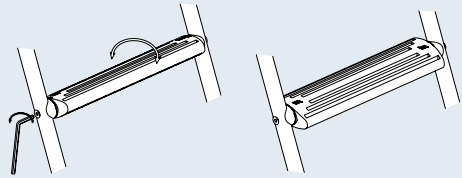

Accessories & Spares

A. Spare stand-offs, st. steel (x 2) 36932
• Ø 22 mm.

B. Stand-off extensions, st. steel (x 2) 12563
• Length 120 mm, Ø 25 mm.

To increase the length of stand-offs in order to incline the ladder slightly and thus facilitate climbing back on board.

C. St. steel fixing plates for stand-off extensions (x 2) 12586
• For tube Ø 25 mm.

If your ladder is fixed permanently, these plates offer 4 fixing points, so as to have a better rigidity of the whole set.

D. St. steel fixing brackets for stand-offs (x 2) 12587
• For tube Ø 22 mm.

Same use as above 12586.

E. Fixing plates with trunnion nut (x 2) 27073
• Suitable for brackets 12586 & 12587.

Allow ladder to be mounted and removed easily

F. Grey step, fixed 58835

• For ladder tube Ø 22 mm, width 295 mm.

G. Grey step, adjustable horizontally 15680

• For ladder tube Ø 22 mm, width 295 mm.

End-pieces and screws included.

ON INCLINED TRANSOMS

H 15° transoms : St. steel fixing brackets stand-offs 35435

• Tube Ø : 25 mm. Length : 22 cm.

For ladders ref. 55700 and 55702.



REF ACCESSORIES	36932	12563	12586	12587	27073	58835	15680	35 435
REF LADDERS	A	B	C	D	E	F	G	H
29181							X	
29390							X	
29392			X		X			
29398		X		X				X
30535	X	X		X	X			X
30536	X	X		X	X			X
55694						X		
55695	X	X		X	X	X		X
55696	X	X		X	X	X		X
55697	X	X		X	X	X		X
55698	X	X		X	X	X		X
55699	X	X		X	X	X		X
55700	X	X		X	X	X		X
55701	X	X		X	X	X		X
55702	X	X		X	X	X		X
55703	X	X		X	X	X		X
55704	X	X				X		X
55705						X		
55706						X		



PLASTIMO
happy boating to you!



COMPASSES | The right course

For over 50 years, Plastimo has been designing and developing compasses suitable for all types of navigation and all types of boats, always focusing on quality and safety.

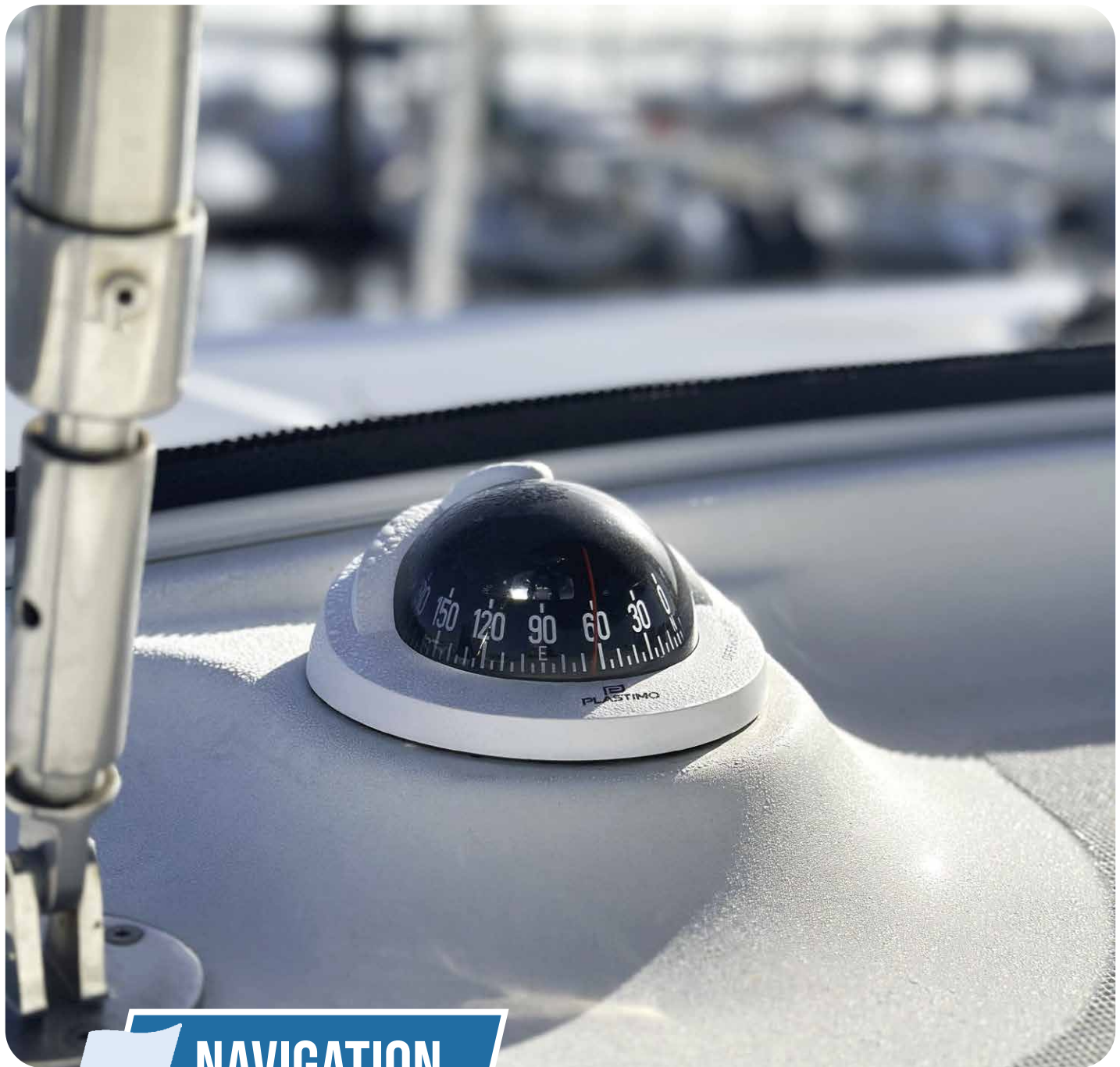

NAVIGATION

Heading compasses	158	AIS Transceivers	192
Tactical compasses	178	Navigation equipment	193
Specialty compasses	179	VHF Radios	194
Compasses for kayak and small boats	180	Chart table equipment	199
Handbearing compasses	181	Marine binoculars	200
GPS	186	Barometers	203
Onboard navigation	187	Codes and signals	205
Sensors	191		



PLASTIMO COMPASSES : OVER 50 YEARS ON THE RIGHT COURSE



For ultimate quality, Plastimo selects the best components in order to ensure that your compass is a highly dependable instrument which will provide years of reliable service.

- Perfectly watertight, Viton® or semi-rigid ultrasonically welded membranes absorb changes in liquid volume caused by temperature and atmospheric pressure variations.
- All plastic components -and more specifically the material used for the dome- are carefully selected to withstand shocks, UV-rays and harsh marine environment.
- The crystal transparency of the dome and the exceptional magnifying index of the fluid contribute to the perfect legibility of the card. .

Viton® is a registered trade mark of Dupont de Nemours

GOOD TO KNOW

The French regulation of October 11, 2024 (Division 240), which governs the safety of pleasure craft, strengthens the technical requirements related to onboard compasses:

It must now be watertight, fixed to the vessel, and visible from the helm.

Independent from any power source, except for lighting. It must display the heading from the main steering position.

It must be Class A or B, properly compensated, and illuminated.

The **magnetic compass** remains a reliable and autonomous solution, allowing the vessel to maintain its course even in the absence of functional electronic systems, thereby ensuring crew safety.

Compasses complying with ISO 25862:

2019 or ISO 14227:2001 standards are considered compliant with this requirement, with no further justification necessary.

QUALITY ASSURANCE : more than just expertise, it's a philosophy

In addition to regulations, each compass must meet Plastimo's stringent requirements. Compasses undergo continuous validation, leaving nothing to chance.

- **Accelerated ageing tests**, carried out in our laboratories, guarantee that the dome and all other components are totally impervious to UV rays.
- **Vibration tests used to simulate the vibrations generated by rough sea and high-speed** : the card must remain absolutely stable, whatever the vibration frequency. While the regulation requires tests from 7 to 40 Hz, Plastimo challenges its compasses to tests between 5 and 100 Hz.
- **Temperature tests** : our compasses are tested in heated and refrigerated cabinets from +60° to -30° C (+180° to -70 °F). Even in these extreme temperatures, the compass must not leak or develop bubbles.
- **Stability tests** : when the card is deflected (40° or 90°), it must return to its original position and settle within a predetermined time (called the "half-period").
- **Precision and accuracy** are tested on each cardinal point. After a 95° deflection, the card must return to its original position, within a 1° maximum allowance.
- **Packaging protection** : in order to guarantee optimum protection during transport, we regularly drop test our packaged compasses from a 1 metre height to a hard surface.
- **Final quality tests** : assembled, packaged and ready for shipment, Plastimo compasses are once again inspected with a statistical sampling.

* Time required for the compass card to swing to the opposite direction and come to a stop after passing the origin point.



5 years
warranty

These stringent tests and quality assurance procedures allow Plastimo to offer a 5-year warranty on all its compasses, and to certify an outstanding quality that meets all European and ISO 25862 specifications.



GUIDED TOUR OF THE COMPAS JEWELLER'S

Produced from state-of-the-art injection moulding machines, domes are individually inspected, thus eliminating the slightest risk of imperfection-optical or mechanical.

Compass production is fully controlled in our Lorient (France) factory. Every compass card is balanced manually to ensure its perfect horizontality.

This is an extremely delicate operation, requiring patient and scrupulous craftsmanship

Printing and legibility of the card must pass microscopic examination. Quality and durability of the printing are fundamental. Once the compass is assembled, the magnification of the card is such that the slightest flaw would be intolerable. Plastimo owes its position as market leader to this uncompromisingly stringent selection of cards.

A Plastimo compass is a meticulously engineered instrument. The complexity of components and the extreme accuracy required at every stage forbids production automation ; every compass is assembled manually. Even when brand new, it already has an interesting history...

The oven test is used to detect possible leaks. Each compass is placed for 1h30 in a cabinet heated to +60 °C. As this produces an expansion of the fluid, the diaphragm compensates for volume fluctuations.



HOW TO SELECT YOUR COMPASS?

Selecting the best compass for your boat is extremely important, as the compass will be the helmsman's or pilot's navigation mate for many years. To help you choose, we suggest that you ask yourself the following simple but essential questions :



© Jean Marie Liot

• What type of boat do you own?

Dinghy, cruising boat, racing boat, powerboat, kayak or yawl... You should know that the main differences between a sailboat and a powerboat (in terms of compass construction) are the heeling angle and the resistance to vibration and shocks. These technical elements are of course integrated in the engineering of our compasses.

• What is your navigation programme ?

Day sailing, cruising, passage making, racing... you will select a compass with or without lighting, with or without compensation, with the right card balanced for the geographical card where you are going to sail, with a plain or tactical card.

• Which size of compass ?

If the compass is designed to be read from a distance, you will need

a larger compass. Generally speaking and as a benchmark indication, you should select a card apparent diameter between 70 and 90 mm, for a 5 to 9 m boat (17-30 ft).

• Which type of mounting ?

Flushmounted on a horizontal, vertical or inclined bulkhead, on a binnacle or minibinnacle, on a bracket, in a take-away or mast-mounted version... you must choose a compass which remains easily readable (shape of card) at all times. The Plastimo range of compasses covers all mounting options and all our models are designed for minimum drilling and screwing. Last but not least, be stylish : often located at the heart of your boat, your compass should ideally match and enhance the character of your boat ; you will therefore pay particular attention to its design and colour.

Flat card

A flat card is read on the back edge, where the lubberline is located. The fluid magnifies the numerals which become easier to read. In addition, the flat card provides a global view of the card and its North point in relation to the boat's direction.



Conical or cylindrical card

Reading from the front and the top of the card. In addition to front reading, this type of card usually features numerals and cardinal points on the top part of the card, thus providing two reading possibilities. This card is particularly suitable when steering or piloting is done sitting or standing



INSTALLATION ON BOARD



FLUSHMOUNT ON HORIZONTAL SURFACE

This extra-flat version provides an excellent viewing angle and also reduces vibrations by absorbing them. On a powerboat, a flushmount compass is ideal for the flybridge, the upper deck or the central steering pod ; on a sailboat, a flushmount compass will be ideally located on either side of the deck or mounted on a binnacle.



BRACKET

Very popular on powerboats, a bracket allows for swift and easy mounting whatever the location. It is particularly suitable on surfaces with awkward angles. A bracket-mount compass can generally be taken away for safe storage, which is a real plus on a powerboat with no cabin.



MINI-BINNACLE

Ultra-slim and compact version ; does not require any cut-out hole. The compass can be taken away for safe storage.



MAST-MOUNTING

If you have only little space available, mast installation can be the answer. It is very easy to carry out thanks to a specific mast mounting kit.



FLUSHMOUNT ON VERTICAL OR INCLINED SURFACE

(often known as bulkhead or dashboard compass)

A bulkhead compass is generally mounted on the cockpit side of the cabin bulkhead, allowing easy viewing from the cockpit (and also from the cabin, with the famous Contest 101). On a powerboat, this is ideally suitable for a vertical dashboard or a central steering pod.



BINNACLE FOR STEERING WHEEL

For sailboats with a steering wheel.



ON FIXING BRACKET

Often a multi-function compass (combines course + handbearing functions), this type of compass is also removable for storage.

COMPENSATION

Compasses are supplied with built-in compensation, or can be further equipped with an optional compensation. Compensating a compass consists in adjusting the position of the 2 magnets, in order to affect the horizontal component of the card by modifying the North/South and East/West deviation. The compensation procedure is a delicate operation and should ideally be carried out by a professional compass adjuster.

How to compensate a compass

Use a second compass as the reference ; a handbearing compass is often the most convenient, provided it is interference-free. The North-South screw corrects North-South heading ; the East/West screw corrects East-West heading.

- Run the boat along the Northerly course selected as per your handbearing compass and adjust your steering compass by turning the North and South screws either way, so that the steering compass also points North.
- Repeat the procedure, running the boat Easterly.
- Run the boat Southerly and this time, reduce the deviation by half.
- Run the boat Westerly and reduce the deviation by half.
- Note : Upon completing the compensation procedure, it is essential to draw a new deviation table.



OFFSHORE® 55 COMPASS



MADE BY PLASTIMO

The ideal compass on **all powerboats up to 6 meters**
Universal balancing



- Bracket mounting: Large, sturdy base to dampen vibrations.
- Card: Safe, reliable navigation whatever the weather or light conditions (perfectly stable conical card, apparent Ø 55 mm). Individual balancing of each card, graduation every 5° in front reading.
- Integrated heading indicator.
- Materials: All parts treated with UV protection, scratch-resistant dome.
- Watertightness: One-piece collar and bowl with integrated membrane for absolute watertightness. Also available with lighting and compensation 5-year warranty.

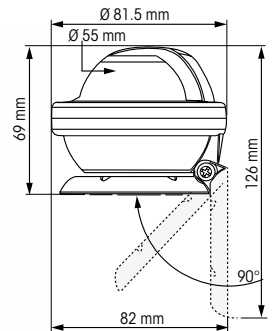

	Ref.	Card colour	Flange	Compass lighting	Compensation
A	63854	Black	White	Optional	Optional
B	63855	White	Black	Optional	Optional
A	P206122	Black	Black	Included	Included
B	P206123	White	White	Included	Included

Accessories

	Ref.	Model
A	62037	LED lamp 12/24 V
B	17673	Compensation box



OFFSHORE® 75



Ideal for motorboats from 5 to 8 m



Mounting:

- Mounted on horizontal surface: very compact (screw attachment).
- Mounted in dashboard: attach to any surface regardless of inclination (screw attachment). Interchangeable with any compass of equivalent size.
- Mini-binnacle: to be fixed on a horizontal surface thanks to a unique bracket system that makes the compass removable.
- Bracket : wide, sturdy vibration-damping base. To be screwed on at any angle, just make sure To make the bracket-mounted compass removable, it can also be fitted with clip-plate.

Balancing zones:

- Zone A: Northern Hemisphere.
- Zone B: South Atlantic, Indian Ocean, Central Pacific, Tahiti, Reunion.
- Zone ABC: Worldwide.

	Ref.	Mounting method	Color	Card type	Card colour	Compass lighting	Compensation	Compass balancing
A	63857	Flush mount	Black	Conical	Black	Included	No	Zone ABC
B	63858	Flush mount	White	Conical	White	Included	No	Zone ABC
A	63859	Dashboard, vertical / sloping bulkhead	Black	Conical	Black	Included	No	Zone AB
C	63860	Dashboard, vertical / sloping bulkhead	White	Conical	White	Included	No	Zone AB
D	63861	On mini-barrel	Black	Conical	Black	Included	Optional	Zone ABC
E	63862	On mini-barrel	White	Conical	White	Included	Optional	Zone ABC
F	63863	On mini-barrel	White	Conical	Black	Optional	Optional	Zone ABC
G	63864	On bracket	White	Conical	Black	Optional	Optional	Zone ABC
H	63865	On bracket, horizontal/ vertical plane	Black	Conical	Black	Included	Optional	Zone ABC
I	63866	On bracket, horizontal/ vertical plane	White	Conical	White	Included	Optional	Zone ABC

Accessories

	Ref.	Model	Description
A	37035	Black stand for compass	Ideal to fix compasses Offshore 75 Mini-binnacle, Offshore 75 and Offshore 95 equipped with a bracket.
B	17673	Compensation box	Mini-Contest, Contest 101 & 130, Mini-B, Offshore 75



OFFSHORE® 75

The Offshore 75 benefits from all Plastimo's compass know-how and industrial technology. Ideal for powerboats from 5 to 8 m. Equipped with the exclusive "Vibration Absorber" system, the Offshore 75 card has exceptional stability in all sailing conditions. Vibration resistance, LCIE test report no. 30 559 010. Exclusive "VIBRATION ABSORBER" system: minimal point of contact between the pivot and the clamp.



Card

Safe, reliable and comfortable sailing whatever the weather conditions and light.

- Perfectly stable tapered card with an apparent diameter of 70 mm.
- Individual balancing of each card.
- Graduation every 5° in frontal reading and compact digits for easy reading.

Lighting

Led integrated to diffuse the light well and guarantees good reading without tiring the eyes.



Lubber Line
Red in color for quick location.

Materials

- All parts anti-UV treated.
- Scratch-resistant dome.

GOOD TO KNOW



Absolute tightness

- One-piece collar and bowl.
- Viton® diaphragm with high expansion and retraction capacity: the diaphragm compensates for liquid volume, temperature and atmospheric pressure variations, preventing bubbles from forming.
- Lighting integrated into the tank.



Access to compensation or lighting

Easy thanks to a unique collar unclipping system. Compensation (optional)
Only bracket and mini-binnacle versions can accommodate the compensation box.

OFFSHORE® 95



Ideal for motorboats from 6 to 10 m.



	Ref.	Mounting method	Color	Card type	Card colour	Compass lighting	Compensation
A	65732	Flush mount	Black	Flat	Black	Included	Included
B	65733	Flush mount	Black	Conical	Black	Included	Included
C	65734	On bracket	Black	Flat	Black	Included	Included
D	65735	On bracket	Black	Conical	Black	Included	Included
E	65736	Flush mount	White	Flat	Black	Included	Included
F	65737	Flush mount	White	Conical	Black	Included	Included
G	65738	Flush mount	White	Conical	White	Included	Included
A	65739	On bracket	White	Flat	Black	Included	Included
H	65740	On bracket	White	Conical	Black	Included	Included
I	65741	On bracket	White	Conical	White	Included	Included

GOOD TO KNOW



Perfect sealing

- One-piece collar and bowl.
- Viton® diaphragm with high expansion and contraction capacity: the diaphragm compensates for variations in liquid volume as a function of temperature and atmospheric pressure, preventing bubbles from forming.

Materials

- All parts UV-treated.
- Scratch-resistant dome.



Lighting

LED lighting for good light diffusion without eye fatigue. Access to compensation or lighting.

Access to compensation or lighting

- Ease through a unique bezel unclipping system.
- Compensation adjustable from the outside without opening the compass on the bracket version.

- Card**
- Exceptional legibility in all weather and light conditions for ease of use and optimum reliability.
- Perfectly stable canonical or flat 81 mm apparent diameter.
 - Individual balancing of each card. Graduation every 5°.

Lubber line
Red for quick identification.



Mounting

- Horizontally mounted: very compact design, bore diameter compatible with the Offshore 90 and other compasses on the market.
- Bracket: wide and sturdy base that absorbs vibrations. Can be screwed in at any angle, ensuring only that the compass/card assembly remains horizontal. To make the compass removable from the bracket, it can also be mounted on the tab

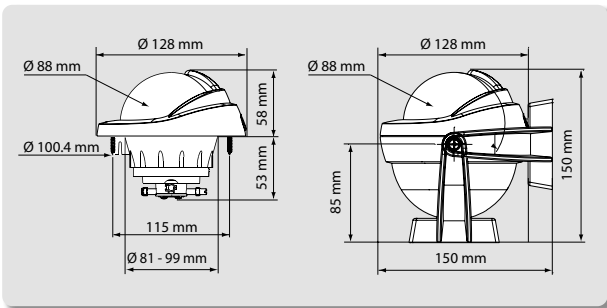

Excellent vibration resistance for improved card stability. Exclusive "Vibration Absorber" system: minimal point of contact between pivot and clamp.



Options and accessories

Protective cover white (ref. 55402) or black (ref. 55599).



Options and accessories

Plasticlip (compass holder ref. 37035).



OFFSHORE® 105



Ideal for motorboats from 8 to 12 m

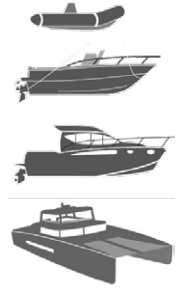
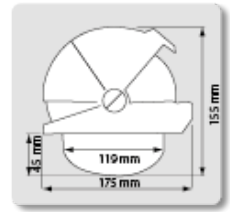

8-12m



A



B



C



D



E

Flushmount or bracket-mounted, it fits all helm stations or instrument panels and features optimal readability. Magnetic shock-mounted equipment for excellent shock and vibration resistance.

- Card : graduated every 5°. Heading reminder every 30°.
 - Multi-zone balancing : around the world with just one compass.
 - Hood : retractable protective hood in 3 sliding sections.
 - Mounting type: supplied as a flush-mount version as standard, it can be bracket-mounted using the optional bracket kit.
 - Shock and vibration resistance: magnetic equipment mounted on shock absorber.
 - Lubber line: 1 lubber line.
 - Lighting : LED 12-24 V.
 - Retractable protective cover: adjust it according to the brightness to avoid reflections. Totally closed, the compass is perfectly protected.
- The bracket version allows the compass to be mounted on a dashboard or bulkhead.
To obtain a bracket-mounted compass, you need to order a flush-mount compass, plus a bracket. The bracket kit includes bracket and screws (black bracket **ref. 17268**, white bracket **ref. 17267**).

Multi-zone balancing: around the world with just one compass.

	Ref.	Color	Card type	Card colour	Compass lighting	Compensation
A	65001	Black	Conical	Black	Included	Included
B	65002	White	Conical	Black	Included	Included
C	65003	White	Conical	White	Included	Included
D	65004	Black	Flat	Black	Included	Included
E	65005	White	Flat	Black	Included	Included

GOOD TO KNOW



Perfect sealing

- One-piece collar and bowl.
- Viton® diaphragm with high expansion and contraction capacity: the diaphragm compensates for variations in liquid volume as a function of temperature and atmospheric pressure, preventing bubbles from forming.



LED lighting

- Energy-saving.
- High shock resistance.
- Extended longevity.
- The same bulb is suitable for 12 or 24 V power supply.

LNE-tested vibration resistance.

- Exclusive "Vibration Absorber" system: minimal point of contact between pivot and clamp.

OFFSHORE® 115



Ideal for motorboats from 8 to 12 meters

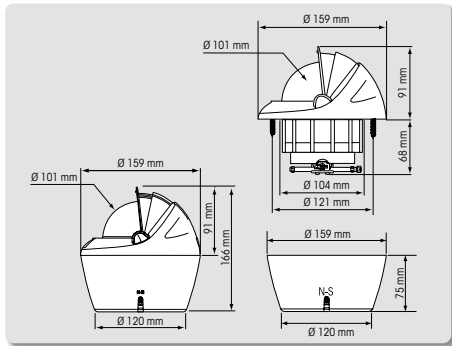

Built-in sliding cover, composed of 3 telescopic parts, with cushioned closing



This compass combines sturdiness and performance. Available with a conical or flat card (1 lubber line), it offers precise graduation every 5° with a heading reminder every 30°. Its retractable protective cover with brake guarantees optimum safety.

Designed to resist shock and vibration, it can be flush-mounted on a horizontal plane or mounted on a binnacle as an option. It incorporates LED lighting for perfect visibility even at night and benefits from compensation as standard. Delivered complete with screws and drilling template, it is SOLAS ISO 25862 approved, ensuring compliance with the most demanding maritime safety standards.

	Ref.	Mounting method	Color	Card type	Card colour	Compass lighting	Compensation
A	60992	Flush mount	Black	Flat	Black	Included	Included
B	60991	Flush mount	Black	Conical	Black	Included	Included
C	60993	Flush mount	White	Flat	Black	Included	Included
D	60990	Flush mount	White	Conical	Black	Included	Included
E	60989	Flush mount	White	Conical	White	Included	Included

Accessories

	Ref.	Model
A	61000	Binnacle for Offshore 115, Olympic 115
B	61001	Binnacle Offshore 115, Olympic 115
C	61002	Offshore 115
D	61003	Offshore 115



OFFSHORE® 135



Ideal for motorboats over 10 m



The famous Offshore compass with retractable cover for motorboats 10 m and over. Flush-mounted or bracket-mounted, it adapts to all helm stations or instrument panels and features optimum readability. Magnetic shock-mounted equipment, for excellent resistance to shock and vibration.

- Card: graduated every 5°, Heading reminder every 30°.
- Hood: retractable protective hood in 3 sliding sections.
- Mounting type: supplied as a flush-mounted version as standard, it can be bracket-mounted using the optional bracket kit.
- Shock and vibration resistance: magnetic crew mounted on shock absorber.
- Lubber line: 1 lubber line.
- Lighting: 12-24 V LED.
- Retractable protective hood: adjust it according to brightness to avoid reflections. Totally closed, the compass is perfectly protected.

Balancing zones:

Zone A: Northern Hemisphere.

Zone B: South Atlantic, Indian Ocean, Central Pacific, Tahiti, Reunion.

Supplied as a flush-mount version as standard, it can be bracket-mounted for dashboard or bulkhead installation.

To obtain a bracket-mounted compass, it is necessary to order a flush-mount compass, plus a bracket.

	Ref.	Color	Card type	Card colour	Compass balancing	Compass lighting	Compensation
A	23484	Black	Conical	Black	Zone A	Included	Included
B	23493	White	Conical	Black	Zone A	Included	Included
C	65350	Black	Flat	Black	Zone ABC	Included	Included
D	65524	White	Flat	Black	Zone ABC	Included	Included
E	23485	Black	Conical	Black	Zone B	Included	Included
B	23494	White	Conical	Black	Zone B	Included	Included

OFFSHORE 105 & 135 MOUNTING BRACKET

Fastened to a slide, the bracket makes the compass removable. The bracket kit includes the bracket and screws.

	Ref.	Model	Color
A	17268	Offshore 105	Black
B	17267	Offshore 105	White
A	17260	Offshore 135	Black
B	17262	Offshore 135	White



MINI-CONTEST®



The precision and ease of reading of the Contest card, in a reduced format for bulkhead mounting on sailboats up to 9 m. Ideal on fast sailing boats and sportsboats.



MINI-CONTEST:

- Red conical card graduated every 5°, apparent Ø 81 mm. Heading reminder every 30°.
- Mounting recessed on vertical bulkhead.
- 3 Lubber lines.
- heeling scale with heading reminder every 10°.
- Balancing: zone ABC worldwide.
- Optional compensation.
- LED lighting 12-24.
- Delivered with protective cover, drilling jig, threaded rods.
- Certified to ISO standard 25862.

Heeling scale : heel return every 10°.

Delivered with protective cover, drilling jig, threaded rods.

	Ref.	Color	Card type	Card colour	Compass lighting	Compensation
A	65742	Black	Conical	Red	Included	Optional
B	65743	White	Conical	Red	Included	Optional



COMPASS MINI-CONTEST ADVANSEA BLACK Z/A

Ref. 28976

The Mini-Contest AdvanSea is a high-precision compass designed to integrate seamlessly with the AdvanSea range of electronic instruments.

- Card: cylindrical card graduated every 5°, Heading reminder every 30°.
- Lubber lines: 3 lubber lines at 45°.
- Heeling scale: heel reminder every 15°. Balancing: zone A (northern hemisphere).
- Lighting: LED 12-24 V.
- Delivered with protective cover, drilling template.

Black card.

Mounting : recessed on vertical plane.

Options and accessories:

AdvanSea protective cover: white ref. 29361

Compensation: ref. 17673.

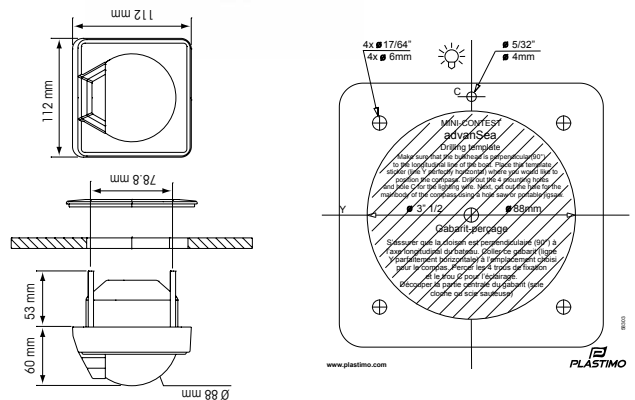



Mounting

Installed on vertical surface:

- Interchangeable with compasses of equivalent size.
- Adapts to all wall thicknesses:
- Normal thickness (40 mm max): threaded rod fixing.
- Thickness greater than 40 mm or boat with counter-molding (fastening by Parker screws on both sides of the partition).

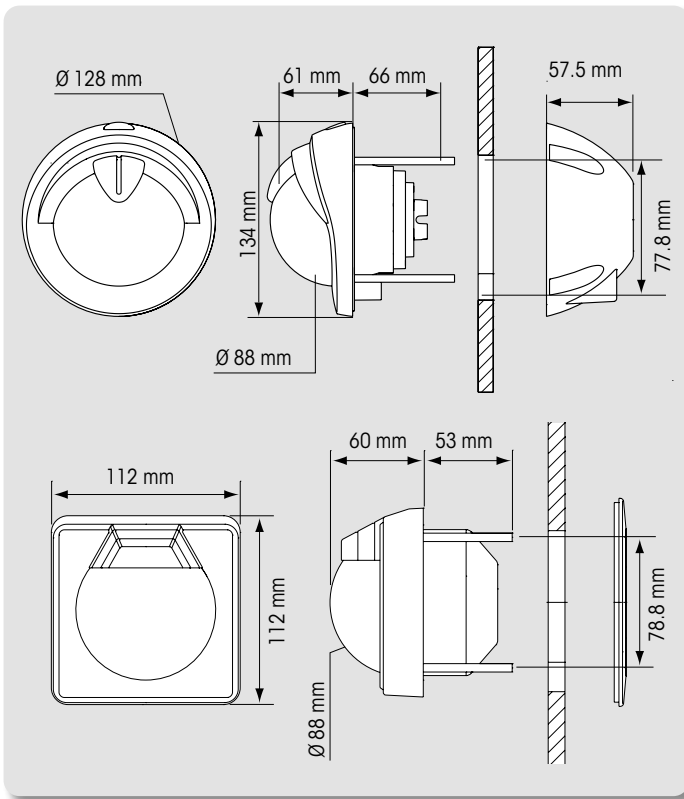

GOOD TO KNOW



Perfect sealing

- One-piece flange and bowl.
- High-expansion Viton® diaphragm: compensates for changes in liquid volume due to temperature and atmospheric pressure variations, preventing bubble formation



Card

- Excellent readability in all weather and light conditions.
- Perfectly stable 81 mm apparent diameter taper.
- Individually balanced.
- Graduation every 5° and compact digits for easy reading.

3 Lubber lines

For comfortable steering even when seated upwind.



Materials

- All parts anti-UV treated.
- Scratch-resistant dome.

Lighting

LED lighting for good light diffusion without eye fatigue. The unique unclipping system of the bezel allows simplified access to the lighting.

Accessories

	Ref.	Model
A	55402	Mini-Contest & Olympic 95
	55599	Mini-Contest, Olympic 95, Offshore 95
B	29361	Mini-Contest Navman/AdvanSea
C	17673	Offshore 75, Mini-B, Mini-Contest, Contest 101 & 130

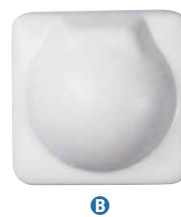

CONTEST® 101



Ideal for sailing boats over 9 m

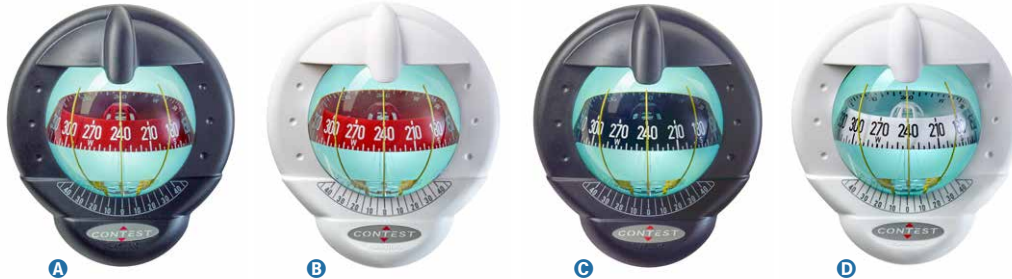
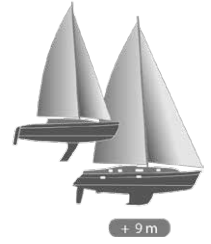

By inventing the dual readout, Plastimo had enabled sailors to follow their course from both cockpit and cabin. The Contest 101 goes even further: its exclusive mounting on any type of bulkhead and its lines enable it to adapt technically and always remain in harmony with the design of today's boats. Designed for boats over 9 m.

- Card: conical with double graduation: horizontal and vertical, graduated every 5°, Heading reminder every 30°.
- Mounting type: delivered as standard in bulkhead mounting version (vertical or inclined from 10 to 25°).
- Lubber lines: 3 Lubber lines, at 45°. heeling scale: heel return every 10°.
- Universal balancing: around the world with a single compass.
- Lighting: LED 12-24 V
- Dual readout: cockpit and cabin side.
- Delivered with protective cover, drilling template.
- Can be mast-mounted with optional mast kit.

The model for inclined bulkhead is designed for an inclination of between 10 and 25°. The card retains its full efficiency and maximum pitching travel without the risk of jamming.

Options and accessories:

- Spare cover: ref. 25332.
- Mast mounting kit: ref. 39201.
- Compensation box: ref. 17673.
- Collar: Black: ref. 26891, White: ref. 26892, Blue: ref. 26893.

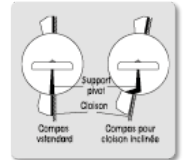
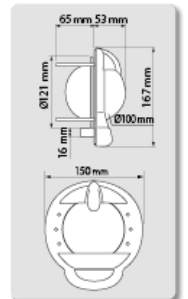

	Ref.	Mounting method	Color	Card type	Card colour	Compass lighting	Compensation
A	64416	Bulkhead-mount vertical	Black	Conical	Red	Included	Optional
B	64417	Bulkhead-mount vertical	White	Conical	Red	Included	Optional
A	64418	Bulkheadmount inclined 10-25°	Black	Conical	Red	Included	Optional
B	64419	Bulkheadmount inclined 10-25°	White	Conical	Red	Included	Optional
C	64421	Bulkhead-mount vertical	Black	Conical	Black	Included	Optional
	64422	Bulkheadmount inclined 10-25°	Black	Conical	Black	Included	Optional
D	64423	Bulkhead-mount vertical	White	Conical	White	Included	Optional
	64424	Bulkheadmount inclined 10-25°	White	Conical	White	Included	Optional

Accessories



	Ref.	Model	Compass
A	26891	Black flange	Contest 101
	26892	White flange	Contest 101
B	39201	Mast mounting kit	Contest 101
C	25332	Spare protective cover	Contest 101
D	17673	Compensation box	Offshore 75, Mini-B, Mini-Contest, Contest 101 & 130

CONTEST® 130



Designed for sailing boats over 9 m

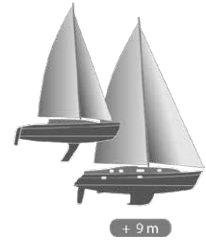

The Contest 130 compass offers exceptional magnification and perfect card stability. It provides users, day or night, with unrivalled reading quality, remaining readable from a distance of 5 m. Selected by competitors in the 2018 Golden Globe Race, the Contest 130 is the choice of sailors who really use their compass.

- Card: double horizontal and vertical graduation, graduated every 5°, heading reminder every 30°.
- Mounting: on bulkhead or bracket.
- 3 Lubber lines at 45°.
- Heeling scale with heading reminder every 10°.
- Lighting: LED 12-24 V.
- Accessory: spare cover **ref. 17296**.
- Delivered with protective cover, drilling template.

The Contest 130 on bracket is more particularly designed for boats with wheelhouse. The removable bracket allows the compass to be fixed in any position. The version for inclined bulkheads is designed for an inclination of between 10° and 25°. The card retains its full efficiency and maximum pitching travel without the risk of jamming.

Balancing zones:

Zone A: Northern Hemisphere.
Zone B: South Atlantic, Indian Ocean, Central Pacific, Tahiti, Reunion.

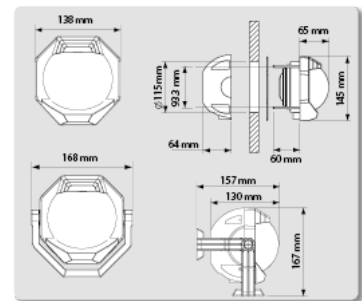

	Ref.	Mounting method	Color	Card type	Card colour	Compass balancing	Compass lighting	Compensation
A	17291	Bulkhead-mount vertical	Black	Conical	Red	Zone A	Included	Included
	17292	Bulkheadmount inclined 10-25°	Black	Conical	Red	Zone A	Included	Included
B	17294	Bulkhead-mount vertical	White	Conical	Red	Zone A	Included	Included
C	17295	On bracket	White	Conical	Red	Zone A	Included	Included
D	39669	Bulkhead-mount vertical	Black	Conical	Black	Zone A	Included	Included
	40034	Bulkheadmount inclined 10-25°	Black	Conical	Black	Zone A	Included	Included
E	17293	On bracket	Black	Conical	Red	Zone A	Included	Included
A	19309	Bulkheadmount inclined 10-25°	Black	Conical	Red	Zone B	Included	Included
B	19844	Bulkhead-mount vertical	White	Conical	Red	Zone B	Included	Included

OLYMPIC® 95 & 100



Olympic 95 : designed for sailing boats up to 9 m
 Olympic 100 : designed for sailing boats from 8 to 12 m

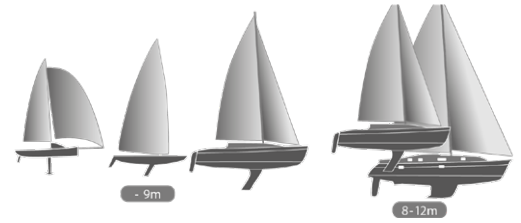

GOOD TO KNOW

Designed specifically for sailboats, the compasses in the Olympic range offer remarkably stable readings and remain usable whatever the angle of heel and weather conditions.

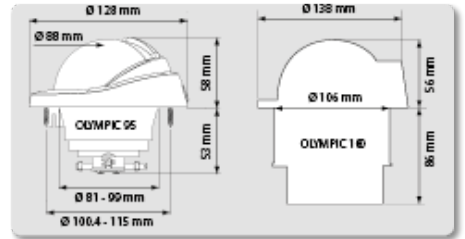

These compasses are equipped with 3 x 45° Lubber lines, offering precise and reliable bearings during navigation. The 12-24 V LED lighting guarantees low power consumption while ensuring comfortable reading, even in the dark. They come complete with drilling template, mounting screws and protective cover.

Compensation as standard.

Card:

- Conic or flat scale graduated every 5°, heading reminder every 30°.
- Excellent legibility in all weather conditions and light.
- Individual balancing.

Materials:

- All parts treated with UV protection.
- Scratch-resistant dome.

Mounting:

- Mounted on horizontal plane.
- Interchangeable with compasses of equivalent size.

Multi-zone balancing: around the world with just one compass. Deck-mounted racing favorite: truly flush with the deck, high-contrast card, perfectly insensitive to heel.

	Ref.	Modèle	Color	Card type	Card colour	Compass lighting	Compensation	Longueur du bateau
A	64762	Olympic 100	White	Flat	Black	Included	Included	8 - 12 m
B	64763	Olympic 100	White	Conical	Black	Included	Included	8 - 12 m
C	65751	Olympic 95	White	Conical	White	Included	Included	Max. 9 m

Accessories

Protective cover

	Ref.	Color	Compass
A	55402	White	Mini-Contest & Olympic 95
A	55599	Black	Mini-Contest, Olympic 95, Offshore 95
B	17287	White	Olympic 100



OLYMPIC® 115



Designed for sailing boats from 6 to 12 m.

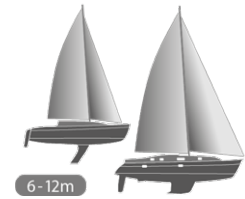

- Card : conical or flat card graduated every 5°, heading reminder every 30°.
- Mounting : flush-mounted or on optional binnacle.
- Lubber lines : 3 Lubber lines, 45°.
- Lighting : 1 LED bulb 12/24 V, standard.
- Compensation : standard, except incased model (max 45°).
- Delivered with protective cover, screws, drilling template.
- Homologation : SOLAS-ISO 25862.

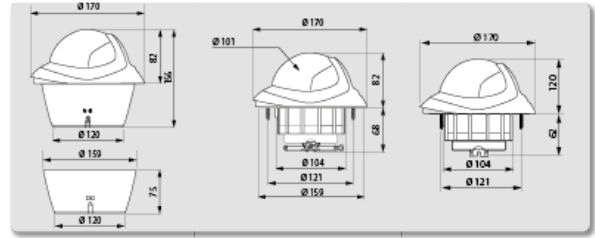

Multi-zone balancing: around the world with just one compass.

Perfect sealing : one-piece collar and bowl.

Guides allow easy access to the compensating screws, without removing the compass from its binnacle.

LED lighting :

- Energy-saving.
- High impact resistance.
- Extended service life.
- The same bulb is suitable for 12 or 24 V power supply.

	Ref.	Mounting method	Color	Card type	Card colour	Compass lighting	Compensation
A	60912	Flushmount on horizontal surface	White	Conical	Black	Included	Included
B	60913	Flushmount on horizontal surface	Black	Conical	Black	Included	Included
C	60996	Flushmount on horizontal surface	White	Flat	Black	Included	Included
D	60997	Flushmount on horizontal surface	Black	Flat	Black	Included	Included
E	60998	Flushmount inclined 45° max	White	Conical	Black	Included	No
F	60999	Flushmount inclined 45° max	Black	Conical	Black	Included	No
G	61205	Flushmount on horizontal surface	White	Conical	White	Included	Included

Accessories

	Ref.	Model
A	61000	Black binnacle
B	61001	White binnacle
C	61004	Black protective cover
D	61005	White protective cover



OLYMPIC® 135



For sailing boats over 9 m

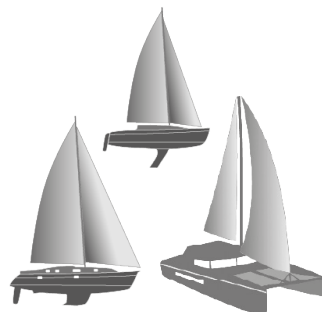

+9m



Compass for flush-mounting on dashboard or wheel steering column, with or without shaft. Large, flat card, ideal for standing helm station.

- Card: flat card graduated every 5°, heading reminder every 30°.
- Hood: retractable protective cover in 3 sliding parts, opening and closing catches.
- Mounting type: flush-mounted on console or wheel steering column, choice of 2 shafts (high: 96 mm); Ø column 175 mm.
- Lubber lines: 3 Lubber lines, at 45°.
- Compensation: standard.
- Lighting: LED 12-24 V.
- Delivered with drilling template.
- Homologation: SOLAS ISO 25862.
- White plastic binnacle only: ref. 10301.

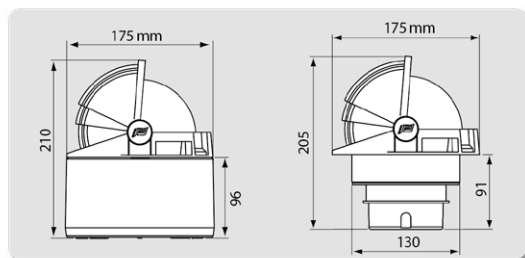

Multizone balancing: around the world with a single compass.

	Ref.	Mounting method	Color	Card type	Card colour	Compass lighting	Compensation
A	65476	Flush mount	Black	Flat	Black	Included	Included
B	65529	Flush or column mounted	Black	Flat	Black	Included	Included
C	65530	Flush or column mounted	Black	Flat	Red	Included	Included
D	65531	Flush or column mounted	White	Flat	Black	Included	Included
E	65532	Flush or column mounted	White	Flat	Red	Included	Included
F	65533	Flush mount	Black	Flat	Red	Included	Included
D	65534	Flush mount	White	Flat	Black	Included	Included
C	65535	Flush mount	White	Flat	Red	Included	Included

Options and accessories

FLUSHMOUNTING KIT FOR OLYMPIC 135 11781

Ensures watertightness when mounting the Olympic 135 compass flat.



BLACK COLLAR FOR OLYMPIC COMPASS 135 70239



OLYMPIC® 135 OPEN



For sailboats and motoryachts over 9 m

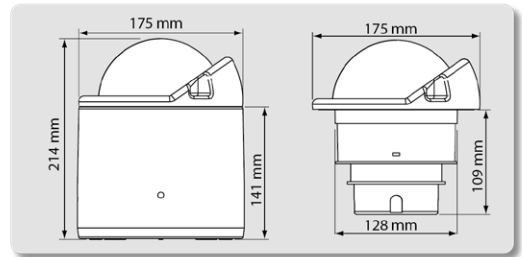
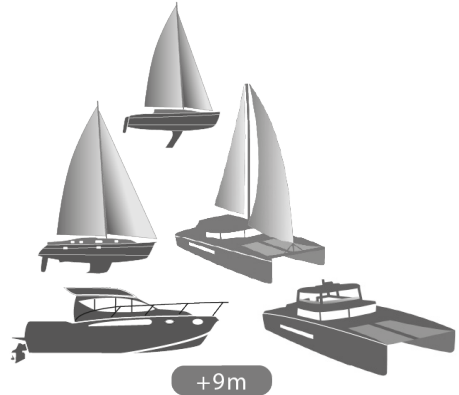

Ideal for sailing and motor catamarans. Compass to be flush-mounted on dashboard or flat deck, or on wheel steering column. Sun cover leaves card clear for a reading angle of over 200°.

- Card : flat card graduated every 5°. Apparent card Ø 130 mm.
- Mounting type: flush-mounted on horizontal plane or on wheelbar column (with optional binnacle).
- Lubber lines : 3 Lubber lines at 45°.
- Compensation : standard.
- Lighting : LED 12-24 V.
- Delivered with Sun visor and protective cover, drilling template.
- Homologation : SOLAS ISO 25862.

Multizone balancing: around the world with just one compass.

	Ref.	Color	Card type	Card colour	Compass lighting	Compensation
A	65514	Black	Flat	Black	Included	Included
B	65523	Black	Flat	Red	Included	Included

Options and accessories

BINNACLE FOR HORIZON 135 & OLYMPIC 135 OPEN
10300

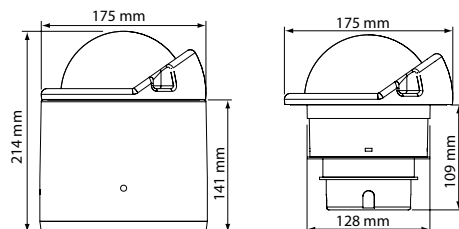



GOOD TO KNOW

The Contest 100 and 101 tactical compasses combine the functions of:

- Classic course compass: on the horizontal part of the card. Heading is read on the Lubber lines fixed in the bottom of the compass.
- Tactical compass: on the vertical part of the card. You only need to memorize one number, for the 3 gaits of an Olympic course.



TACTICAL IRIS 100 COMPASS

Ref. 63867

Delivered with protective cover, bracket and mounting screws. Multi-position: removable because it clips onto a bracket, it easily finds its place on board, whether mounted vertically, horizontally, flat or even upside down.

- Tactical conical card with dual reading (vertical and horizontal).
- Gimbal-mounted: the card is always horizontal, whatever the inclination of the mounting plane.
- 6 mobile Lubber lines.
- Weight: 295 g.
- ISO 25862 compliant.

Additional bracket: ref. 22477. A 2nd bracket on board multiplies mounting possibilities.

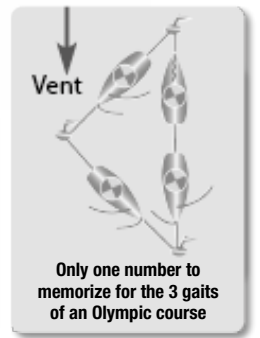
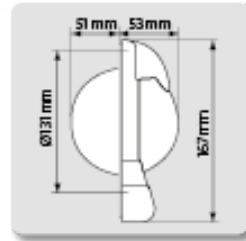
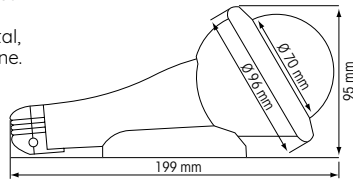

TACTICAL CONTEST 101 COMPASS

Ref. 64425

Sailboats from 8 to 12 m

Delivered with protective cover.

- Double reading: cockpit side and cabin side.
- Apparent diameter of card: 100 mm.
- Standard lighting (LED 12/24 V).
- Integrated heeling scale.
- ISO 25862 compliant.

Option: compensation box ref. 17673.

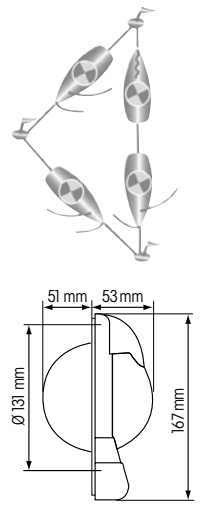
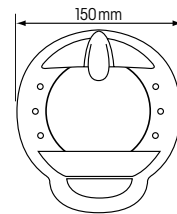

TACTICAL OLYMPIC COMPASS

Ref. 17250

Dinghies, small catamarans, light and sport boats under 9 m.

- Curved flat tactical card.
- Apparent card diameter: 85 mm.
- Equipped with 5 Lubber lines.
- Weight: 375 g.

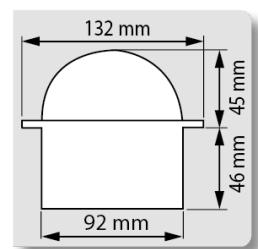





A

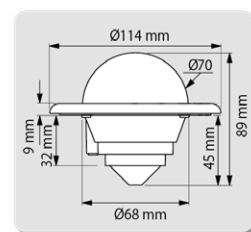

B



MINI-C COMPASS



Designed for all types of use (dinghy, cruising, motorboating...), the Mini-C compass is universal: whatever the available space on your boat, the Mini-C compass will find its place thanks to its gimbal-equipped cell. Flush-mounted, it's easy to fit: flat, on a bulkhead, dashboard or console.

- Dual-reading conical card (vertical and horizontal).
- Apparent card diameter: 70 mm.
- Gimbal-mounted equipment, allowing the card to remain horizontal whatever the inclination of the mounting plane.
- Equipped with 2 mobile Lubber lines.
- Optional lighting.
- ISO 25862 compliant.

Option : 12/24 V LED lighting: ref. 62037.

	Ref.	Color	Card type	Compass lighting	Compensation
A	63868	Black	White conical card	Included	no
B	63869	White	White conical card	Included	no



MINI-B OLYMPIC COMPASS

Ref. 17233

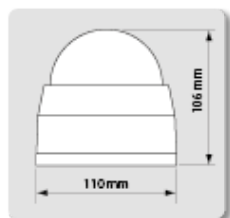

Designed for light boats (under 9 meters). Avoid having to drill a hole for the compass flush mount: 3 screw holes are all that's needed.

The cell is very easy to assemble and disassemble (in a quarter turn), eventually allowing removal after each outing.

- Apparent card diameter: 90 mm.
- Moveable Lubber lines.
- Card pivot mounted on shock absorber.
- Optional compensation: ref. 17673.



DORIS COMPASS

Ref. 66485



Traditional compass for small boats.

Presented in a satin-finish varnished wooden case.

- White card graduated in all degrees and intercardinal points.
 - Multizone balancing.
 - Apparent card diameter: 72 mm.
 - 1 lubber line and 2 Lubber lines at 45°.
 - Gimbal suspension.
 - Roll 60°, pitch 30°.
 - Transparent Plexiglas cover.
 - Dimensions: 152 x 152 x 100 mm.
- Multizone balancing.

MADE BY PLASTIMO



OFFSHORE® 55 - KAYAK VERSION

Ref. 63856



Materials:
All parts UV-treated, scratch-resistant dome.

Card:
Safe and reliable navigation whatever the weather and light conditions (perfectly stable conical card, apparent Ø 55 mm).
Front reading.

Watertightness:
One-piece collar and tank with integrated membrane for absolute watertightness.

Integrated heading indicator.

Bracket mounting:
Large, sturdy base to dampen vibrations.
Fixed to the kayak's lifeline using the elastic bands and hooks supplied.
Card : tapered graduated every 5°.
Heading recall every 30°.

The ideal partner for your kayak tours and hikes. Black card, orange bezel.

Mounting type: on bracket with two elastics and 4 hooks.

Reading : 1 integrated heading marker.

Delivered with: integrated swivel bracket, elastics + hooks and screws.

Universal balancing.

5-year warranty

Options:

- Compensation box: ref. 17673.
- Lighting (LED lamp 12/24 V): ref. 62037.
- Kit 2 elastics with hooks: ref. 63853.

Options

Ref.	Accessories
63853	Kit of 2 replacement bungee cords for Offshore 55 compass, Kayak version. Includes 2 bungee cords with hooks.
62037	LED lamp 12/24 V
17673	Compensation box

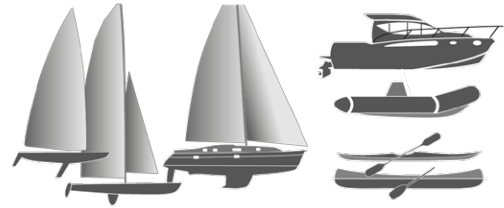

Multi-position mounting



IRIS 100 COMPASS

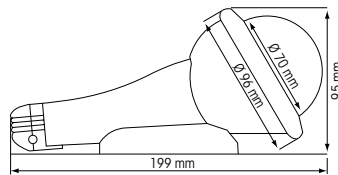

Universal: the Iris 100 is both a course compass and a bearing compass.

Multi-position mounting: ideal for sailboats (light dinghies, sportsboats, houseboats), small cliferaft (kayaks, canoes, fishing), or speedboats and RIBs because of its ability to dampen vibrations.

- It can be mounted on any surface: vertical, horizontal flat, upside down...
- It's removable because clipped onto a bracket designed to avoid snagging ropes and "grating" fingers.
- It's protected against shocks thanks to its flexible elastomer collar and cap.
- Floating.
- Double-reading conical card (vertical and horizontal).
- Gimbal-mounted: the card is always horizontal, whatever the inclination of the mounting plane.
- Equipped with 3 movable Lubber lines.
- The pivot/stone pairing that has made Plastimo compasses famous for their longevity and accuracy.

Delivered complete with protective cover, mounting bracket and screws.

Multizone balancing.

Multiposition.

	Ref.	Compass balancing	Color	Compass lighting	Compensation
A	63874	Zone ABC: Worldwide	Blue	no	no
	63875	Zone ABC: Worldwide	Blue	Included	no
B	63876	Zone ABC: Worldwide	Yellow	no	no
	63877	Zone ABC: Worldwide	Yellow	Included	no

Accessories

Ref.	Accessories
64952	Cell for Iris 100.
22477	Additional bracket to multiply the mounting possibilities of a single compass.



MADE BY PLASTIMO



IRIS 50 COMPASS

A true icon of the Plastimo brand, the Iris 50 accompanies yachtsmen, regatta sailors and professional racers around the world.

Bearing and orientation compass: seaworthy, strong and highly accurate, it is regularly praised by the international press and the most prestigious skippers.

- Protection against shocks; pleasant to the touch, it won't slip, even when wet.
- Infinity-projected graduation: prevents parallax errors and significantly improves reading comfort. No need to switch between near vision to read the card and infinity vision to sight the mark.
- Optimum comfort when bearing, whatever the sea state, thanks to the stability of the card and the 20° width of the field of vision.
- Precision of the bearing thanks to the hardness of the virtually wear-free and shockproof pivot/stone couple.
- Flexible-bottom cell ultrasonically welded to prevent any bubbles from appearing and any risk of leakage over time.
- Top-mounted heading readout allows you to know the heading without looking through the prism (as with a steering compass).
- Exceptional legibility of the card graduated from degree to degree by very high-definition silkscreen marking.
- Integrated photoluminescent lighting, requiring no maintenance, insensitive to oxidation, operating without batteries or radioactive tritium.

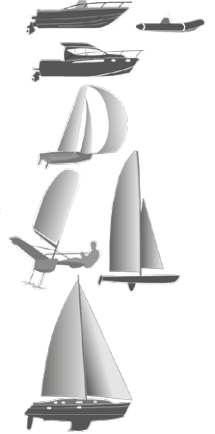

Balancing zone AB : North Hemisphere, South Atlantic, Indian Ocean, Central Pacific, Tahiti, Reunion.

	Ref.	Color
A	63599	Orange
B	63603	Sand
C	63870	Blue
D	63871	Yellow
E	63873	Khaki
F	63601	Pink

- Both bearing and orientation functions
- Graduation : every 1°
- Field of view : 20°
- Clearance : 12°
- Built-in photoluminescent lighting
- Red rubber lines

5 years warranty

Accessories



	Ref.	Modele
A	38184	Case in navy blue coated canvas, foam-lined interior. Closed by a resistant composite plastic snap.
B	1997004	Bamboo stand for release compass.
C	17244	PVC holder

CUSTOMIZE YOUR IRIS 50

Choose the color of your Iris 50 and display your logo on the back of the compass. As precise and efficient in the desert as on the water! Sandproof, shockproof and night-readable without a power source.

Military and land use:
 Khaki (ref. 63873) and sand (63603) models are also available on request in MILS graduation.
 Graduation in MILS + MILS:
 - Direct reading: graduation every 4000 MILS.
 - Sight reading (prism): graduation every 200 MILS.
 63879: IRIS MILS/MILS KHAKI Z/AB





PROTECTIVE COVER FOR SAILBOAT COMPASSES

	Ref.	Model	Color
A	17308	Mini-Contest (before 2009)	White
B	55402	Mini-Contest & Olympic 95	White
C	29361	Mini-Contest Navman/AdvanSea	White
D	17287	Olympic 100	White
E	17302	Contest 100	White
F	25332	Contest 101	Grey

	Ref.	Model	Color
G	17296	Contest 130	White
H	61004	Olympic 115	Black
I	61005	Olympic 115	White
J	29403	Olympic 115, with screws	Black
K	29404	Olympic 115, with screws	White
L	17280	Horizon 135	White

PROTECTIVE COVERS

For powerboat compasses: Offshore 105.

	Ref.	Model	Color
A	55599	Mini-Contest, Olympic 95, Offshore 95	Black
B	14451	Offshore 105	Black
	14450	Offshore 105	White
C	61002	Offshore 115	Black
D	61003	Offshore 115	White
E	14453	Offshore 135	Black
	14452	Offshore 135	White



PLASTIMO



BINNACLES

	Ref.	Model	Color
A	61000	Binnacle for Offshore 115, Olympic 115	Black
B	61001	Binnacle Offshore 115, Olympic 115	White
C	10301	Binnacle for Olympic 135 Open	White
D	10300	Binnacle Olympic 135	White
	P202310	Binnacle Olympic 135, ABS	Black



BEZEL

For Contest 101.

	Ref.	Model	Color
A	26891	Contest 101	Black
	26892	Contest 101	White



COMPASSES FOR BOAT BUILDERS

Plastimo compasses - Boat builder version

To meet the specific needs of construction sites and builders, Plastimo offers certain compass models with male connector. Supplied in neutral white packaging, each model comes with a Wago two-way connector, guaranteeing time-saving assembly. Available in batches, they offer a practical and efficient solution for series-equipping boats.

- 12-24 V LED lighting included.

	Ref.	Model	Mounting method	Card type	Compass balancing	Packaging	Compensation
A	63878	Offshore 75	Flush mounted	Black conical card	Zone ABC: Worldwide	1 Box = 20 Each	Optional
B	65526	Olympic 135	Flush or column mounted	Black flat card	Zone ABC: Worldwide	1 Box = 8 Each	Included
C	65752	Offshore 95	Flush mounted on horizontal surface	Black conical card	Zone ABC: Worldwide	1 Box = 20 Each	Included
D	70161	Olympic 95	Flush mounted on horizontal surface	White conical card	Zone ABC: Worldwide	1	Included
E	70162	Contest 130	Bulkhead-mount vertical	Black conical card	Zone A: Northern Hemisphere	1	Included

GOOD TO KNOW

Compasses manufactured from 2016
LED lamp 12/24V : 62037
(included Offshore 115 & Olympic 115 since 2014)

LED lighting:

All Plastimo compasses are now equipped with LED lamps whose consumption is 70% lower than filament bulbs. A LED lamp lasts longer, and is equally suitable for 12 or 24 V power supplies.



PLASTICLIP FOR COMPASS

Ideal for mounting Offshore 75 mini-binnacle, Offshore 75 and Offshore 95 compasses on brackets.
Suitable for all Ø 18.5 to 25.5 mm tubes.

	Ref.	Model	Color
A	37035	Black stand for compass	Black
B	17673	Compensation for Offshore 75, Mini-B, Mini-Contest, Contest 101 & 130	-
C	37036	Offshore 75 & 95	Light gray

BRACKETS

More than just an aesthetic choice, mounting the compass on a bracket allows the compass to be moved away from the dashboard, keeping it away from elements likely to disturb the magnetic field.



Ref.	Brackets for	Color
14444	Offshore 70	Black
55579	Offshore 75	White
17268	Offshore 105	Black
17267	Offshore 105	White

Ref.	Brackets for	Color
17260	Offshore 135	Black
17262	Offshore 135	White
38473	Contest 130	Black
38474	Contest 130	White

AROUND THE WORLD WITH MY COMPASS

UNIVERSAL BALANCE : around the world with one compass

The recent generations of Plastimo compasses are balanced to sail around the world with one single compass. So much easier for the round-the-world racer or the boater on a world passage, so much simpler too for the boatbuilder who selects one single compass, whatever the final destination of the boat.

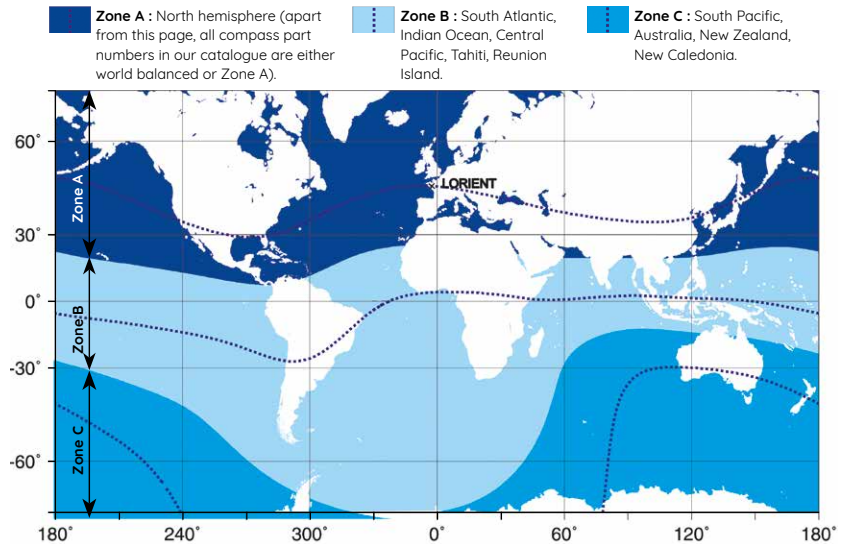

ITALIC references : Universal compass, one single part number to sail around the world.

Description	Zone A	Zone B	Zone C	Description	Zone A	Zone B	Zone C
Offshore 55, bracket mount, black, black card	<i>World : 63854</i>			Contest 130 black, black card, inclined bulkhead	40034	40035	40036
Offshore 55, bracket mount, white, white card	<i>World : 63855</i>			Contest 130 black, red card, std	17291	19296	19299
Offshore 55 kayak, orange, black card	<i>World : 63856</i>			Contest 130 black, red card, inclined bulkhead	17292	19309	19317
Offshore 75 horizontal flush, black	<i>World : 63857</i>			Contest 130 black, red card, bracket	17293	19328	19332
Offshore 75 horizontal flush, white	<i>World : 63858</i>			Contest 130 white, red card, std	17294	19844	19854
Offshore 75 vertical flush, black	63859	63859	48843	Contest 130 white, red card, bracket	17295	19868	19871
Offshore 75 vertical flush, white	63860	63860		Mini-Contest black, conical card	<i>World : 65742</i>		
Offshore 75 mini-binnacle, black	<i>World : 63861</i>			Mini-Contest white, conical card	<i>World : 65743</i>		
Offshore 75 mini-binnacle, white	<i>World : 63862</i>			Mini-Contest AdvanSea, black	28976		
Offshore 75 basic, mini-binnacle, white, black card	<i>World : 63863</i>			Olympic 95 flushmount	<i>World : 65751</i>		
Offshore 75 basic bracket mount, white, black card	<i>World : 63864</i>			Olympic 100 flushmount, black card	<i>World : 64763</i>		
Offshore 75 bracket mount, black	<i>World : 63865</i>			Olympic 100 flushmount, red card	<i>World : 64762</i>		
Offshore 75 bracket mount, white	<i>World : 63866</i>			Olympic 115 black, black flat card, std	<i>World : 60997</i>		
Offshore 95 black, black flat card, flushmount	<i>World : 65732</i>			Olympic 115 black, black conical card, std	<i>World : 60913</i>		
Offshore 95 black, black conical card, flushmount	<i>World : 65733</i>			Olympic 115 black, black conical card, inclined surface	<i>World : 60999</i>		
Offshore 95 black, black flat card, bracket	<i>World : 65734</i>			Olympic 115 white, black flat card, std	<i>World : 60996</i>		
Offshore 95 black, black conical card, bracket	<i>World : 65735</i>			Olympic 115 white, black conical card, std	<i>World : 60912</i>		
Offshore 95 white, black flat card, flushmount	<i>World : 65736</i>			Olympic 115 white, black conical card, inclined surface	<i>World : 60998</i>		
Offshore 95 white, black conical card, flushmount	<i>World : 65737</i>			Olympic 115 white, white conical card, std	<i>World : 61205</i>		
Offshore 95 white, white conical card, flushmount	<i>World : 65738</i>			Olympic 135 black+binnacle, red card	<i>World : 65530</i>		
Offshore 95 white, black flat card, bracket	<i>World : 65739</i>			Olympic 135 black+binnacle, black card	<i>World : 65529</i>		
Offshore 95 white, black conical card, bracket	<i>World : 65740</i>			Olympic 135 white+binnacle, red card	<i>World : 65532</i>		
Offshore 95 white, white conical card, bracket	<i>World : 65741</i>			Olympic 135 white+binnacle, black card	<i>World : 65531</i>		
Offshore 105 black, black flat card	<i>World : 65004</i>			Olympic 135 black, red card	<i>World : 65533</i>		
Offshore 105 black, black conical card	<i>World : 65001</i>			Olympic 135 black, black card	<i>World : 65476</i>		
Offshore 105 white, black flat card	<i>World : 65005</i>			Olympic 135 white, red card	<i>World : 65535</i>		
Offshore 105 white, black conical card	<i>World : 65002</i>			Olympic 135 white, black card	<i>World : 65534</i>		
Offshore 105 white, white conical card	<i>World : 65003</i>			Olympic 135 Open, red card	<i>World : 65523</i>		
Offshore 115 black, black flat card	<i>World : 60992</i>			Olympic 135 Open, black card	<i>World : 65514</i>		
Offshore 115 black, black conical card	<i>World : 60991</i>			Olympic tactical	17250		
Offshore 115 white, black flat card	<i>World : 60993</i>			Contest 101 tactical	<i>World : 64425</i>		
Offshore 115 white, black conical card	<i>World : 60990</i>			Iris 100 tactical, blue	<i>World : 63867</i>		
Offshore 115 white, white conical card	<i>World : 60989</i>			Mini-C black	<i>World : 63868</i>		
Offshore 135 black, black flat card	<i>World : 65350</i>			Mini-C white	<i>World : 63869</i>		
Offshore 135 black, black conical card	23484	23485	23486	Mini-B Olympic	17233		
Offshore 135 white, black flat card	<i>World : 65524</i>			Doris compass	<i>World : 66485</i>		
Offshore 135 white, black conical card	23493	23494	23495	Iris 50 blue	63870	63870	21809
Contest 101 black, black card, standard	<i>World : 64421</i>			Iris 50 yellow	63871	63871	24049
Contest 101 black, black card, inclined bulkhead	<i>World : 64422</i>			Iris 50 olive green	63873	63873	38181
Contest 101 black, red card, std	<i>World : 64416</i>			Iris 50 orange	63599	63599	63600
Contest 101 black, red card, inclined bulkhead	<i>World : 64418</i>			Iris 50 sand	63603	63603	63604
Contest 101 white, red card, std	<i>World : 64417</i>			Iris 100 blue	<i>World : 63874</i>		
Contest 101 white, red card, inclined bulkhead	<i>World : 64419</i>			Iris 100 blue + lighting	<i>World : 63875</i>		
Contest 101 white, white card, std	<i>World : 64423</i>			Iris 100 yellow	<i>World : 63876</i>		
Contest 101 white, white card, inclined bulkhead	<i>World : 64424</i>			Iris 100 yellow + lighting	<i>World : 63877</i>		
Contest 130 black, black card, std	39669	39670	39671				

GOOD TO KNOW

Plastimo is the reference for safety at sea, both in leisure sailing and in competition. So that sailing rhymes with performance, Plastimo has selected SAILMON, "The" GPS dedicated to light sailing. An ally for the crew, combining precision and modernity in a compact package. A technological answer in a robust, waterproof and wireless case.



SAILMON MAX

Ref. 70215

The SAILMON MAX GPS is the most advanced navigation instrument in its class. It will become the benchmark for your race starts or leisure sailing on dinghies or sport keelboats, to increase your navigation speed and give you useful information in real time. This data is recorded continuously, so you can replay the race, analyze and compare your performance.

- Position.
- Speed.
- Cap.
- Leading angle.
- Pitch.
- Countdown/Chrono.
- Distance from line at start.
- VMG.

Features:

- Compact design: Height 93 x Width 118.5 x Depth 22 mm.
- Light: 275 g.
- Robust & 100% waterproof.
- Induction charger included.
- 16h battery life with 3600 mAh lithium-polymer battery.

- Antiglare display - 4.4" - 320 X 240 pixels.
- Settable large-format display.
- Integrated 25 Hz GNSS (GPS, GLONASS, Galileo, Beidou) deactivatable.
- Inertial power unit.
- Wifi & Bluetooth.
- Internal memory (up to 6 days of navigation).
- 2-year warranty.

Delivered with:

- Gopro™ type stand.
- Protective case.
- Induction charger.
- Screw-in bracket.

With optional wireless ultrasonic wind sensor (ref. 70216) for additional readings:

- Apparent wind angle and speed.
- Actual wind angle and speed.
- Actual wind direction.
- Wind graph.

Other option: Wind sensor bracket (ref. 70221).

SAILMON MAX BRACKET

For attaching your Sailmon Max to your boat. Available as a flat screw-on bracket or single or double mast bracket.

	Ref.	Model
A	71044	Flat bracket
B	70607	Single mast bracket
C	70608	Double mast bracket

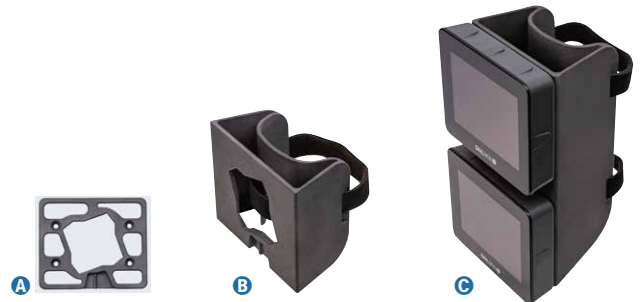

WIND SENSOR

	Ref.	Model
A	70221	Support for Calypso wind sensor
B	70216	Wireless ultrasonic wind sensor allowing additional reads: Apparent wind angle and speed Actual wind angle and speed Actual wind direction Wind graph



advanSea



GOOD TO KNOW

Instruments are the core component of any yacht navigation system. The advanSea S400 series uses cutting edge technology to provide accurate data for cruisers or racers. Compass, repeater and Wi-Fi interface are great additions that definitely make the S400 series a solid value set of instruments.

- Accuracy, optimal legibility, flexibility and ease of installation are the key benefits of the S400 series, together with easy intuitive operation with direct function access.
- LCD screens with wide-angle viewing and super size digits for unmatched visibility. Watertight display fascia (IP66) ; displays feature an anti-fogging coating for optimal safety even in extreme conditions. The S400 series is available with a choice of compatible transducers manufactured by Airmar or Plastimo.

The instruments can also operate as 'stand alone' with intelligent transducers or an NMEA0183 source.



DEPTH S400 SOUNDER

- High-performance, giant-character (45 mm)
- Depth indication display from 1.50 to 100 m* (5 to 330 ft) with keel offset.
 - Trend (depth) indication by arrow.
 - High and low depth alarm.
 - Low battery alarm.
 - Simulation mode.
- Instrument supplied with protective cover.
*Depending on sensor used.



	Ref.	Model
A	57748	Display only Depth
	63756	Complete, with Airmar transducer (ref. 61669)



LOCH- SPEEDO S400

LOCH-SPEEDO, giant characters (45 mm), supplied with protective cover.

- Display only, without sensor.
- Surface speed: 0-60 knots, 0-69 mph, 0-111 km/h.
- Bottom speed possible if connected via NMEA0183.
- Total and daily log.
- Elapsed time and countdown timer.
- Water temperature.
- Trend indication (speed) by arrow.
- High and low surface speed alarm.
- Low battery alarm.
- Simulation mode.

Ref.	Model
63757	Complete, with Plastimo transducer (40640)
57749	SPEED Display only

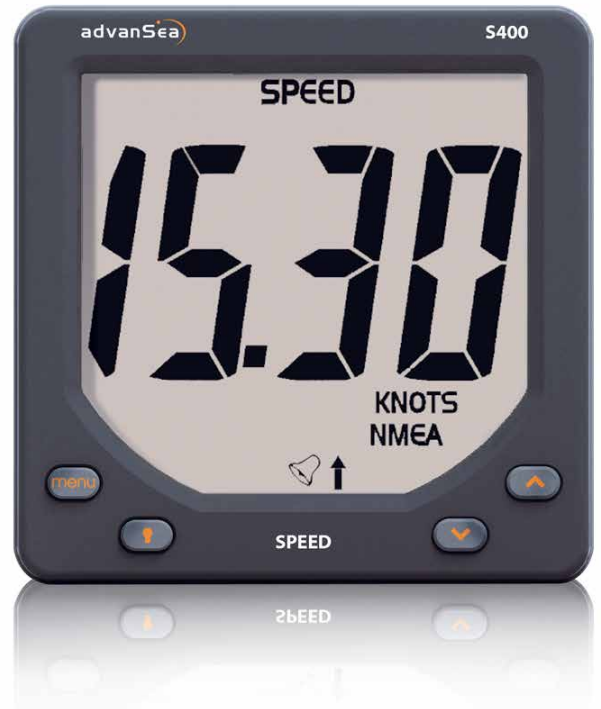

MULTI S400 LOG-SPEEDO/DEPTH

- All Depth and Speed functions.
Only 2-line display.
- Lower part: 22 mm high character.
 - Upper part: 32 mm high character.
 - Trend indication (depth and speed) via arrow.
 - Proprietary bus interface and NMEA0183 input/output.
 - Simulation mode.
- Instrument supplied with protective cover.

Ref.	Model
63758	Complete, with transducers (40640 & 61669)
57750	Display only Multi





WIND S400 DIGITAL WIND VANNE-ANEMOMETER

All essential wind information on digital display

- Instantly displays wind direction in digital form.
- Display on 2 configurable lines (32 mm top, 22 mm bottom).
- Proprietary Bus interface and NMEA0183 input/output.
- Wind speed (0 to 199 knots).
- 360° wind direction.
- Trend indication
- True* and apparent wind angle and speed.
- 1° resolution in direction.
- High wind alarm.
- Low battery alarm.
- Simulation mode.
- Instruments supplied with protective cover.
- * If connected to a speedometer measuring surface speed or GPS.

Ref.	Model
57751	Complete Wind with mastheadunit + 25 m cable
57752	Display only Wind



WIND-A S400 ANALOGIC WIND VANNE-ANEMOMETER

Displays wind direction in analog form.
Takes over all the functions of the Wind.
Instruments supplied with protective cover.

Ref.	Model
57753	With mastheadunit + 25 m cable
57754	Display only Wind-A



SPARE PARTS FOR WIND& WIND-A SENSOR

	Ref.	Accessories
A	57763	25 m cable for masthead
B	58706	Wind vane cups
C	58707	Wind vane blade
	62345	Bucket bearing kit
	63482	Paddle bearing kit





ADVANSEA MASTHEAD TRANSDUCER UNIT

High-quality design with aluminum bearings and arms. Extremely low start-up threshold for very high responsiveness even in very light winds. Heavy-duty waterproof connector.

Ref.	Model
57761	Complete, with 25 m cable
57762	Masthead only



S400 REPEAT DISPLAY ONLY

Ref. 67039

Repeat S400, display only.

- Apparent wind direction and speed.
- Depth (with and without offset).
- Surface speed and bottom speed (with and without offset).
- Water temperature.
- Daily log and totalizer.
- Compass heading information.

Features:

- Display on 2 lines: 32 mm high on top line, 22 mm on bottom line.
- Proprietary bus interface and NMEA0183 input/output.
- Simulation mode.

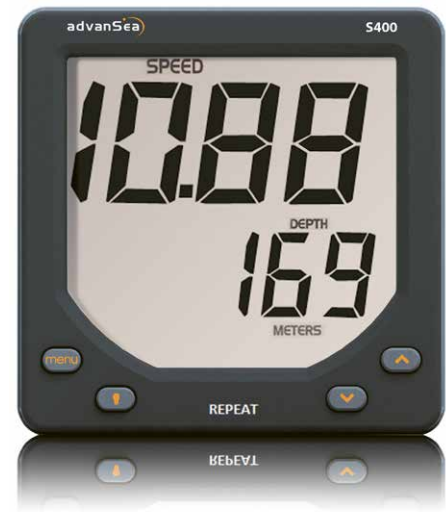

ECHOTEST II DEPTH SOUNDER

Ref. 38074

The Echotest II is an easy-to-use, hand-held fishfinder. It's ideal for users of inflatable boats, or small cliferaft. It's also very useful for divers: it lets you know your exact position in relation to the bottom, the distance to a rock or an underwater dock. Totally waterproof, it probes up to 80 m and can be used down to a depth of -50 meters. To display a value, the Echotest must be submerged.

- Frequency: 200 kHz.
- Depth scales: 1 m to 80 m (3 ft to 240 ft).
- Display: 7-segment LCD, LED backlighting.
- Power supply: 9 V alkaline battery, type 6 F 22 or 6LR61 (not supplied).
- About 500 uses.
- Consumption: 70 mA.
- Waterproof up to 50 m.
- Dimensions: D.42 x long. 198 mm.
- Weight: 200 g (with battery).





THROUGH-HULL, FIXED AIRMAR P319 MONO-FREQUENCY

Ref. 61669

For advanSea S400 Multi and Speed. Compatible with Navman Multi Depth 100 and 3100 devices.

- 200 kHz.
- 12° beam.
- Plastic body.
- Diameter: 51 mm.
- 9 m cable.
- RCA plug.
- Max 200 m.



AIRMAR ST850 45-KNOT SPEED SENSOR

Ref. 57768

Sensor traversing 45 knots. For advanSea S400, Multi and Speed. Compatible with Navman Multi and Speed 3100 devices.

- Speed and temperature.
- Removable hull cover with Check valve.
- Diameter 51 mm.
- Cable 9 m.
- LT8 plug.



30-KNOT SPEED SENSOR

Speed and temperature. Removable plastic grommet.

- Diameter: 41 mm.
- Cable 8 m.
- LT8 plug.

For advanSea S400 Multi and Speed. Compatible with Navman Multi and Speed 3100.

Ref.	Model
40640	Complete with through-hull
42285	Without through-hull



PLASTIC THROUGH-HULL, AIRMAR P319 DUAL-FREQUENCY

Ref. 58416

- 50/200 kHz.
- 45/12° beam.
- Diameter: 51 mm.
- 10 m cable.
- LT6F socket.
- Max. 350 m.



THREE-FUNCTION AIRMAR DST800 NMEA 0183 SENSOR

Ref. 66996

Removable through-hull sensor compatible with all NMEA0183 peripherals (Multi S400, Depth and Speed S400, Repeat S400, Advansea WiFi interface, chart reader, navigation software, radar, etc...).

- Speed, temperature and depth.
- Removable through-hull sensor.
- Non-return valve / Diameter 51 mm.
- 10 m cable / no connector.
- Power supply 10 to 25 V / <40 mA.
- Depth 70 m maximum.

Sensor calibration (e.g. keel offset) requires a PC, USB/serial adapter and Airmar's WeatherCaster software.



GOOD TO KNOW

Probes ref 58146, 54940 and 57769 are compatible only with:

- Advansea C56
- Navman :
 - Fish 4500 / Fish 4600 and above
 - Trackfish 6500 / Trackfish 6600 and above
 - 8084 & 8120



IN-HULL PUCK, AIRMAR P79 DUAL-FREQUENCY

Ref. 54940

- 50/200 kHz.
- 45/12° beam.
- 10 m cable.
- LT6F plug.
- Compensation up to 22° slope.



TRANSOM MOUNT AIRMAR P58 DUAL-FREQUENCY/SPEED/TEMP.

Ref. 57769

- <50/200 kHz. 45/12° beam. 10 m cable. LT6F plug. Max. 350 m.
- For advanSea C56 and selected Navman devices: Fish 4500 / Fish 4600 and higher Trackfish 6500 / Trackfish 6600 and higher 8084.



GOOD TO KNOW

AIS transceivers

Always safer with AIS solutions for everyone! Display all AIS information on your chartplotter GPS, or your PC, and track the navigation of nearby vessels. Compatible with all AdvanSea chartplotters.



SPLIT-110 VHF/AIS ANTENNA SPLITTER

Ref. 61906

Allows you to use a VHF radio and an AIS transmitter or receiver simultaneously on a single VHF antenna. Also allows connection of an FM link.

What is AIS?

The AIS system, Automatic Identification System or automatic identification system, is a system for the automatic exchange of data (boat position, MMSI, length, beam, course, speed, type of surrounding boats equipped with AIS transmitters), through the VHF marine radio band.

Specifications & performance advanSea AIS



devices:

- Power supply: 12 to 24 VDC
- Consumption: < 150 mA@12 VDC
- Electrical connections: VHF antenna output (SO239 connector). VHF radio input (SO239 connector). BNC connector for AIS
- Supplied with power cable, VHF interface cable, AIS interface cable, user manual, quick start guide, warranty card, CD and mounting screws.
- User interface: 3 LEDs for power, VHF transmission and AIS transmission
- Operating temperature: -10°C to +55°C
- Waterproofing: IPX7

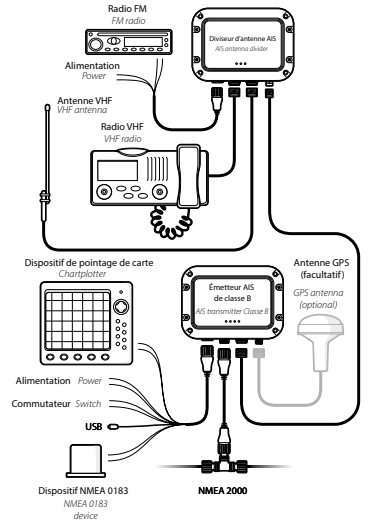

ADVANSEA TR-210 AIS TRANSCIVER CLASS B

Ref. 61904

See and be seen.

- Compact and waterproof, the Class B AIS transceiver enables the transmission and reception of AIS information from a pleasure boat.

Registration is as simple as entering the MMSI number and some boat information, via the supplied PC software.

- The TR-210 AIS connects to the GPS chartplotter via its NMEA 0183 interface, and to your PC via the USB connection. The GPS antenna required to locate the boat is internal to the product. An external GPS antenna can also be connected if required (ref. 62173).

Specifications & performance advanSea AIS devices:

- Power supply: 12 to 24 VDC
- Consumption: 170 mA@12 VDC
- Electrical connections : NMEA 0183, 38400 Baud (output), NMEA 0183, 4800 Baud (input), USB, NMEA 2000®
- Supplied with cable (power, NMEA 0183 & USB), user manual, quick start guide, warranty card, CD and mounting screws.
- User interface: 4 LEDs for power, transmission time-out, error and Silence mode
- Operating temperature: -25°C to +55°C
- Waterproofing: IPX7

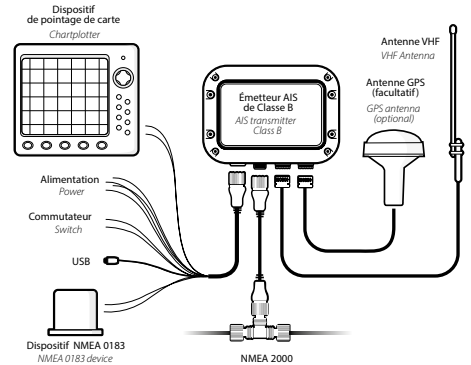

AIS TR-210 OPTIONNAL EXTERNAL ANTENNA

Ref. 62173





WINDY HANDHELD ANEMOMETER

Ref. 49357

- Wind reading in all directions thanks to the 3-bucket aerial.
- Waterproof and unsinkable.
- Backlighting triggers automatically in low-light conditions. Automatic shutdown after 60 seconds of bucket immobilization for optimum battery economy.

Wind speed:

- Scale: 1.0 to 40 m/s.
- Units: knots, m/s, km/h, mph in digital form. Beaufort in graphic form.
- Maximum speed.
- Average speed over 5, 10, 20 or 40 selectable seconds.
- Precision: 4%.
- Resolution: 0.1 up to 9.9. 1 above 10.

Ambient air and windchill temperatures:

- Scale: -20 to + 60 °C.

- Precision: 1 °C.
- Units: °C or °F.
- Resolution: 1 °C

Features:

- Dimensions: height 135 mm, Ø 7 cm (including cups).
- Weight: 70 g with battery.
- Power supply: 1 x 3 V lithium battery type CR2032 (Supplied).
- Battery life: 8000 hours (up to 10 years). 100 hours with backlighting.
- Large backlit display with 2 customizable lines.
- Characters up to 15 mm high.

Options and accessories:

- Holder ref. 49359: Wall or flat mounting. For storage or measuring with tripod.
- Spare kit ref. 49358 1 aerial 3 buckets.



Options and accessories

	Ref.	Accessories
A	49359	Support for anemometer: Wall or flat mounting for storage or tripod measurement.
B	49358	Spare kit. 1 aerial 3 cups.



A



B



Two models of waterproof and buoyant portable marine VHF offering up to 13 hours of autonomy with exceptional transmission and reception clarity.

GOOD TO KNOW

The VHF, essential to your safety.

In most countries, a waterproof, floating portable VHF is mandatory on board of all boats sailing more than 60MN from a shelter (in addition to a fixed VHF). It is only recommended for coastal navigation within 2 NM of a shelter. As this is essential communication and therefore safety equipment, Plastimo recommends that you carry a portable VHF when dinghy sailing and in addition to your grab bag, whatever your sailing category.



SX-350+ HANDHELD VHF

Ref. P203922



VHF marine portable waterproof and floating. European version, USA-Canada compatible • Power 1/3.5 W.

- Frequencies 156-163.275 MHz.
- Autonomy 13 hours (depending on ratio 5% transmit, 5% receive, 90% standby).
- Integrated Li-ion battery delivering 1750 mA.
- Double standby, triple standby and scan functions.
- Weather function (10 channels & alert, USA only).
- Vibrating water drain: drains water away from the speaker.
- Direct access to Channel 16 or a programmable favorite channel.
- Possibility of activating channels M1 & M2 for the UK and 31 for Belgique (use prohibited in France).
- Large backlit LCD display (34 x 25 mm).
- Keyboard with large backlit keys.
- Optional handheld microphone/speaker (P203926).
- Operating temperature : -20 to +60°C.
- Weight: 201 g (battery, antenna and belt clip included).
- Waterproofing IPX7: Protected against immersion to 1 m for 30 minutes (provided the plug for the remote microphone socket is perfectly closed). (IP = Protection Index).
- Charging via waterproof USB-C plug.
- Warranty: 2 years.

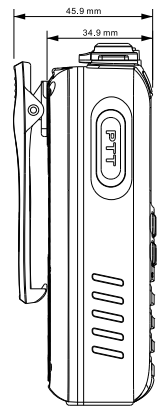
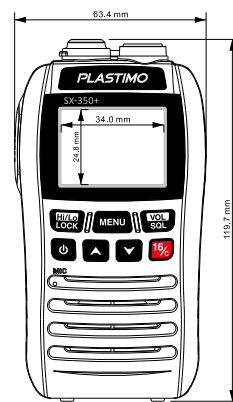

GOOD TO KNOW



Waterproof rating IPX7: protected* against immersion at 1 m for 30 minutes.

* provided that the plug for the remote microphone socket is perfectly closed (IP: Protection Index).



- Delivered with:
- 12 V cigarette lighter/USB-C adapter.
 - 220 V mains/USB-C adapter.
 - USB-C cable.
 - Strap and belt clip.



SX-400+ HANDHELD VHF

Ref. P203923

2 years warranty

Marine VHF portable waterproof and floating with exceptional transmit and receive clarity, thanks to ambient noise reducer. European version, USA-Canada compatible.

- Power 5 W.
- Frequencies 156-163.425 MHz.
- Autonomy 12 hours (according to ratio 5% transmit, 5% receive, 90% standby).
- Li-ion battery delivering 1750 mA.
- Ambient noise reducer.
- English and French menu.
- Double standby, triple standby and scan function.
- Weather function (10 channels & alert, USA only).
- Automatic vibrating water drain.
- Direct access to Channel 16 or a programmable favorite channel.
- Possibility of activating channels M1 & M2 for the UK and 31 for the Belgique (use prohibited in France).
- ATIS function for river navigation.
- Large backlit LCD matrix display (39 x 25 mm).
- Keyboard with large backlit keys.
- Optional handheld microphone/speaker (ref. P203926).
- Operating temperature : -15° to +55°C.
- Weight: 230 g (battery, antenna and belt clip included)
- Floating, with alarm + flashlight on immersion
- Waterproof to IPX7.
- Charging via waterproof USB-C socket.
- Warranty: 2 years.



REMOTE SPEAKER MICROPHONE

Ref.	Model
67575	For SX-350 & SX-400
P203926	For SX-350+ & SX-400+



Delivered with:

- 12 V cigar-lighter/USB-C adapter.
- 220 V mains/USB-C adapter.
- USB-C cable.
- Strap and belt clip.



Charging via USB-C socket



SPARE PARTS FOR HANDHELD VHF RADIOS

Ref.	Model	VHF
P203927	Belt clip	SX-350, SX-350+
P203928	Belt clip	SX-400, SX-400+
P203929	Antenna	SX-350(+), SX-400(+)
P203933	Wrist strap	SX-350(+), SX-400(+)
P203930	220 V/USB-A adapter	SX-350
P201071	USB/jack charging cable	SX-350
P203931	12V Cigarette Lighter to USB-A Adapter + Micro USB Cable	SX-400
P203932	220 V VHF SX-400 charger with micro USB cable	SX-400
P203934	Portable VHF jack plug cap	SX-350, SX-400
P203935	USB-C plug cap	SX-350+, SX-400+
P203936	220 V/USB-C adapter	SX-350+, SX-400+
P203937	12 V/USB-C cigarette lighter adapter	SX-350+, SX-400+
P203938	USB-C cable	SX-350+, SX-400+

**CLEAR COMMUNICATION
FOR SAFE NAVIGATION**

PLASTIMO
happy boating to you!



HANDHELD VHF SX-350+

- 3,5 W power
- Large backlit LCD screen
- IPX7 waterproof rating
- Charging via waterproof USB-C port
- Supplied with 220V and 12V chargers

SX-400+

- 5W power
- Ambient noise reduction
- Large backlit LCD matrix screen
- IPX7 waterproof rating
- Charging via waterproof USB-C port
- Supplied with 220V and 12V chargers
- ATIS mode for inland waters
- Menu in French and English

FIXED VHF FX-500+

- 25 W power
- Large backlit LCD matrix screen
- IPX7 waterproof rating
- Removable microphone
- DSC function, class D
- ATIS mode for inland waters
- Menu in English and French
- GPS antenna included : GPS and GLONASS





A fixed VHF is compulsory on board in semi-offshore and offshore navigation (beyond 6 MN from a shelter).

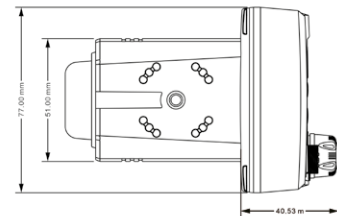
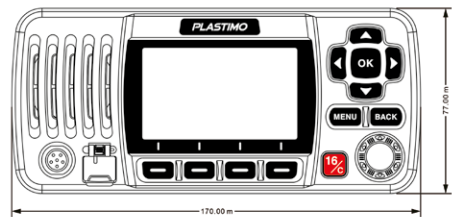
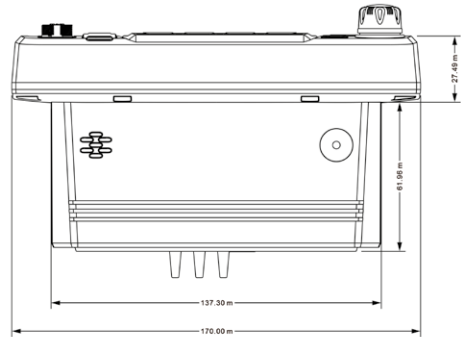

GOOD TO KNOW



IPX7 waterproof rating:
Waterproof front panel (IP: protection index)

FX-500+ FIXED VHF, DSC - GPS

Ref. P203925



Fixed DSC VHF with remote GPS antenna. European version, USA-Canada compatible. Compact and waterproof, the VHF FX-500+ is very easy to use thanks to its menu in english.

- Power 1/25 W.
- Equipped with a removable microphone.
- Wired GNSS antenna included: GPS & GLONASS with 5 m cable, fixing by magnet or double-sided adhesive.
- Vibrating drain to evacuate water from the speaker.
- External HP output.
- Large, backlit matrix LCD display.
- 4 front-panel, programmable quick-access keys.
- DSC function, class D.
- ATIS mode for European inland waters.

- GPS page with display of time, position, heading and speed.
- Scan function: configurable scan of favorite channels.
- Double watch & triple watch.
- 3 channel groups: International, USA and Canada.
- Possibility of activating channels M1 & M2 for the UK and 31 for Belgium (use prohibited in France).
- Channels and weather alert (USA only).
- French and English menu (user manual in 8 languages).
- NMEA 0183 compatible.
- RED-approved.
- IPX7 front waterproofing.
- Warranty: 2 years.

GOOD TO KNOW

All fixed VHF's must be equipped with a receiver enabling satellite positioning.

The FX-500+ VHF features a GNSS receiver that calculates position via the GPS and GLONASS satellite constellations.



FLUSH MOUNT KIT FOR FIXED VHF

Ref. P206260

Flush-mounting kit, compatible with FX-500 and FX-500+ fixed VHF radios.

PLASTIMO

happy boating to you!



Discover our
binoculars



BINOCULARS

SUPERIOR OPTICAL QUALITY BINOCULARS, OPTIMIZED FOR USE IN MARINE ENVIRONMENT

TRADITIONAL BRITISH DIVIDERS

Compass with soft-friction joint, adjustable. 17 or 20 cm in length. Straight or bow model.

	Ref.	Length	Material
A	10556	17 cm	BRASS Stainless steel
	10558	17 cm	BRASS Stainless steel
	1020021	20 cm	BRASS Stainless steel
B	1020022	20 cm	BRASS Stainless steel
	1020011	20 cm	BRASS
	1020012	20 cm	BRASS



HOLDER FOR HAND DIVIDERS

Ref. 17118

For compasses up to 20 cm. Compass sold separately.



EVOLUTION CRAS PLOTTER

Ref. 1990022

Cras evolution rule. Lighter lines, two-tone engraving on PVC.

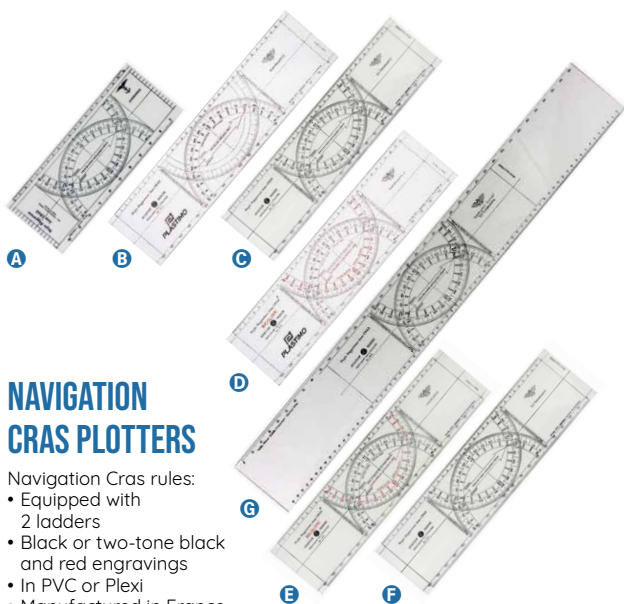
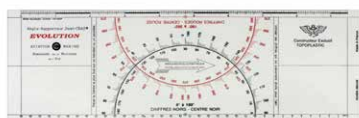

NAVIGATION CRAS PLOTTERS

Navigation Cras rules:

- Equipped with 2 ladders
- Black or two-tone black and red engravings
- In PVC or Plexi
- Manufactured in France

	Ref.	Length	Material	Color
A	1990005	210 mm	PVC	Black
B	29519	385 mm	PVC	Black
C	1990009	385 mm	PVC	Black
G	1990002	385 mm	PVC	Black
D	29520	385 mm	PVC	Black / Red
E	1990012	385 mm	PVC	Black / Red
E	1990003	385 mm	PVC	Black / Red
F	1990001	385 mm	Plexiglass	Black
G	1990004	730 mm	Plexiglass	Black

INTEGRAL CRAS PLOTTER

Ref. 1990016

Combines the two-colour Jean CRAS ruler with the TOPO protractor. The rotating window ensures that the course reading is always facing the user, even on southbound headings.

An exclusive yellow background provides easy reading over printed chart areas.

Figures from 180° to 360° are engraved in red, both on the rotating protractor and on the Jean CRAS ruler. Black and red engraving on 1 mm PVC. Length: 380 mm

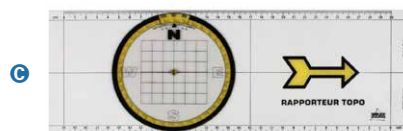
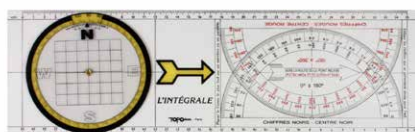

NAVIGATION PROTRACTOR

Protractor-style navigation ruler.

Made of PVC. Unalterable graduations for years of accurate reading. Dimensions: 33 x 12 cm.

	Ref.	Color
A	29521	Black
B	1990017	Black
C	1990015	Yellow / Black



A



B

MARINE BINOCULARS

For over 40 years, Plastimo has been offering marine binoculars of superior optical quality, optimized for use at sea. A complete range, adapted to the needs of all boaters: ergonomic, they offer an excellent grip. Rubber sheathing favors their robustness: they are shock and weather resistant.

	Ref.	Model	Magnification	Optical prism type	Field of view	Waterproofing	Color	Optical Ø	Length	Weight
A	1045000	Admiral FX 7 x 50 binoculars	7	BAK-7	123 m	Splashproof	Black	50 mm	185 mm	790 g
B	40561	Marine binoculars 7 x 50	7	BAK-7	119 m	Splashproof	Black	50 mm	175 mm	790 g



MONOCULAR

Lightweight, compact 8 x 42 monocular that incorporates a compass with value scale for measuring object size. Multi-coated optics for improved light transmission.

Ref.	Magnification	Optical Ø	Focus	Waterproofing	Field of view	Type of prism	Weight	Dimensions
61380	8	42 mm	Eyeiece	Immersion	123 m	BAK-7	370 g	143 mm



WATERPROOF MARINE BINOCULARS

The models below are equipped with BAK-4 prisms. All our binoculars are delivered with case, strap and cleaning cloth.

	Ref.	Model	Eyepiece	Focus	Waterproofing	Field of view	Color	Length	Weight
A	1045025	Amiral FX immersion-proof binoculars, high-resolution autofocus optics. Rubber coating.	50 mm	Autofocus	Immersion	115 m	Black & blue	200 mm	880 g
B	1045030	Amiral RC 7 X 50 immersion-proof binoculars. High-resolution, centrally-adjustable optics. Rubber coating.	50 mm	Central	Immersion	115 m	Black & blue	200 mm	920 g
C	1045038	RESCUE 7 x 50 COMPASS waterproof floating binoculars, high-resolution optics, focusing on each eyepiece. Magnetic compass with battery illumination. Compass fully operational between 40° and 60° North latitude.	50 mm	Eyepiece	Immersion	132 m	Black & yellow	200 mm	900 g
D	1045039	RESCUE 7 x 50 floating waterproof binoculars, high-resolution optics, focus on each eyepiece.	50 mm	Eyepiece	Immersion	132 m	Black & yellow	200 mm	800 g

Options and accessories



	Ref.	Model
A	31248	Floating strap for binoculars
B	31256	Binocular storage holder



A



B

BINOCULARS

	Ref.	Model	Magnification	Focus	Waterproofing	Field of view	Length	Weight
A	1045061	Pocket 7 x 18	7	Eyeiece	Immersion	163 m	85 mm	160 g
B	1045070	Mini 8 x 21	8	Central	Splashproof	131 m	90 mm	150 g

SELECTED BY PLASTIMO

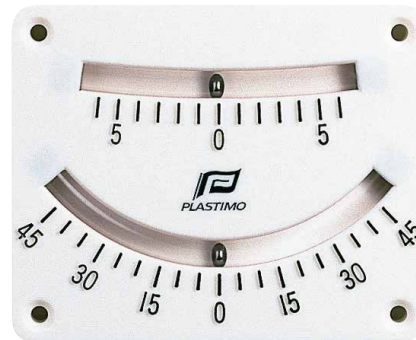

A



B

LOUD HAILER WITH BUILT-IN MICROPHONE

Ref. 61682

- Equipped with a class D amplifier.
- Maximum power 25 W.
- 4 functions: conversation, whistle, foghorn and siren.
- Average range: 450 meters
- Powered by 10 AA batteries, (not included).
- Autonomy: approx. 8 hours.
- Weight (without batteries): 950 g.
- Ø 203 mm.
- Length: 350 mm.

HEELMETERS

Indispensable for setting the boat's trim in the water, from dinghies to Class 1. Designed for indoor or outdoor use.

	Ref.	Model	Mounting	Dimensions
A	51494	Dual-reading inclinometer 6° and 45° scale	4 screws	110 x 82 mm
B	51601	45° inclinometer	Self-adhesive mount	80 x 40 mm



SOLID BRASS PORTHOLE BAROMETER

- High-sensitivity aneroid movement with integral metal chain.
- 2 scales: mbar and mmHg.
- Beveled glass.
- Available in various sizes.

	Ref.	Model	Dial Ø	Base Ø
A	12762	6"	15 cm	22 cm
B	31230	4,5"	11.5 cm	14 cm
C	12767	4"	8.8 cm	13 cm



4" MATT CHROME CLOCK AND TIDE INDICATOR

Ref. 38209

- Quartz mechanism.
- Arabic numerals.
- Beveled glass.
- Ø of dial: 8.8 cm.
- Ø of base: 13 cm.



4,5" SOLID BRASS PORTHOLE CLOCK AND TIDE INDICATOR

Ref. 56051

- Quartz mechanism.
- Arabic numerals.
- Beveled glass.
- Ø of dial: 11.5 cm.
- Ø of base: 14 cm.



SOLID BRASS PORTHOLE CLOCK

- Roman numerals.
- Quartz mechanism.
- Beveled glass.
- Available in various sizes.



	Ref.	Model	Dial Ø	Base Ø	Alarm	Silence zones
A	12763	6"	15 cm	22 cm	-	no
B	31229	4,5 "	11.5 cm	14 cm	-	no
C	12765	3"	8.8 cm	13 cm	-	no
D	12766	3"	8.8 cm	13 cm	Incl.	no
E	12768	3"	8.8 cm	13 cm	-	yes

SOLID BRASS PORTHOLE THERMOMETER HYGROMETER

- Temperature in °C and °F.
- Beveled glass.
- Available in different sizes.
- Precision (no adjustment possible):
+/- 5% on the hygrometer.
+/- 2° C on the thermometer.

	Ref.	Model	Dial Ø	Base Ø
A	31231	4,5"	11,5 cm	14 cm
B	18683	3"	8,8 cm	13 cm



4" MATT CHROME CASE THERMOMETER HYGROMETER

- Temperature in °C and °F.
- Beveled glass.
- Precision (no adjustment possible):
+/- 5% on hygrometer.
+/- 2° C on thermometer.

	Ref.	Model	Dial Ø	Base Ø
A	35885	4" hublot	8,8 cm	13 cm
B	38208	4" design épuré	8,8 cm	13 cm



NAUDET

Paris, depuis 1860

NAUDET BAROGRAPH MAHOGANY

Intemporal, the Naudet barograph is a compact, high-quality, high-precision recording barometer. Designed for use at sea, it can also be used at home. Made in France.

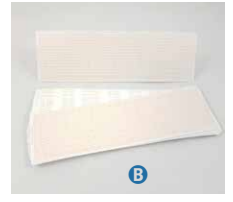

	Ref.	Model	Description
A	27184	Naudet Barograph	Complete barograph
A	27185	Replacement Styluses for Barographs	Essential accessory for the Naudet barograph. Produces an even, visible line.
B	27186	Chart Papers for Barographs	Diagrams in moisture-resistant paper. Scale 970 to 1040 hPA. Dimensions: 6.7 x 22 cm.

PLASTIMO



4" MATT CHROME BAROMETER

- High-sensitivity aneroid movement with integral metal chain.
- 2 scales: mbar and mmHg.
- Beveled glass.

	Ref.	Model	Dial Ø	Base Ø
A	35884	4" porthole	8,8 "	13 cm
B	38207	4" refined bezel	8,8 cm	13 cm

PLASTIMO



4" MATT CHROME CLOCK

- Quartz mechanism.
- Beveled glass.

	Ref.	Model	Dial Ø	Base Ø	Silence zones
A	54779	4" porthole	8,8 cm	13 cm	1
B	35886	4" porthole	8,8 cm	13 cm	0
C	38206	4" refined bezel	8,8 cm	13 cm	0

PLASTIMO



4" PORTHOLE CLOCK AND BAROMETER ON WOOD BOARD

Ref. 12764

Solid brass 4" porthole clock and brometer. Mounted on wooden base (32.5 x 15 cm).

PLASTIMO



WEATHERMAN

Ref. 12761

Watch, barometer, thermometer, hygrometer: all the information you need about the weather on a single dial.

- Mounted on teak base.
- Dial Ø: 20 cm.
- Teak base: Ø: 35 cm.

Spare glasses

Ref.	Model
24142	Spare glass with needle (gold screw). For 3" porthole barometer.
35591	Spare glass with needle. For 4.5" porthole barometer - ref. 31230
24141	Spare glass with needle. For 6" porthole barometer - ref. 12762
24144	Spare glass for 3" porthole-type clock. Also suitable for a thermometer-hygrometer or tide indicator. refs 12765/6/8/9 and 35485/6.
35590	Spare glass for 4.5" porthole-type clock. Also suitable for a thermometer-hygrometer or tide indicator. Refs 31229-31.
24143	Spare glass for 6" porthole-type clock. Also suitable for a thermometer-hygrometer or tide indicator.

PLASTIMO

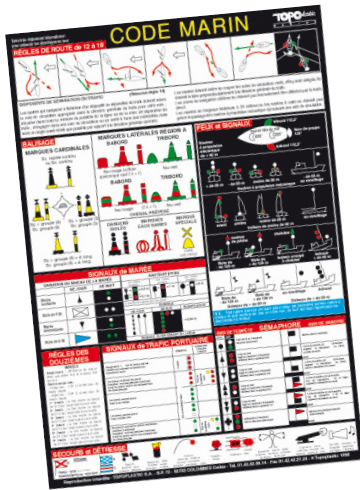

MARINE CODE ADHESIVE

Ref. 1990046

- Color print on adhesive PVC.
- Size 21 X 29.7 cm.



FLAG CODE ADHESIVE

Ref. 1990041

- Main navigation flags and signals.
- Color print on adhesive PVC.
- Size 21 X 29.7 cm.



CODE OF MARITIME SIGNALS (FRENCH)

Ref. 17144

Ø 22 cm



MINI CODE REGATTA ADHESIVE

Ref. 1990047

- Main flags used for regatta regulation signals.
- Color printing on adhesive PVC.
- Size 21 X 12 cm.



SAFETICS - LA CHECK-LIST DES MARINS

Ref. 1067016

Inspired by aviation, it contains all the documents required in France for coastal navigation (Div 240).

SELECTED BY **PLASTIMO**

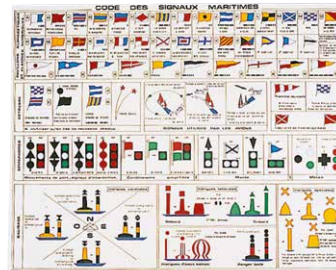

INTERNATIONAL CODE OF SIGNALS (FRENCH)

Ref. 17143

Packaging : 5



PLASTIMO

happy boating to you!



Discover our
dora boxes

STREAMLINED DORADE BOXES

TECHNICAL DESIGN FOR SAFETY ON BOARD: UV RESISTANCE, SIMPLE INTEGRATION



© Clément Le Calvé

COMFORT

Cowl vents and dorade boxes208

Fabric windsocks210



PLASTIMO VENTS

Plastimo's air pipes: over 50 years of experience with tempered PVC, a process also used for turnbuckle covers, compass hoods, binocular cases, and more.

Flexibility, UV resistance, ease of installation, and glossy finish are the qualities universally recognized in Plastimo air pipes.

	Ref.	Color	Overall width	Diameter	Built-in diameter
A	16922	Blue	170 mm	75 mm	60 mm
B	16923	Blue	190 mm	90 mm	90 mm
C	16924	Blue	120 mm	75 mm	60 mm
D	16926	Blue	140 mm	90 mm	80 mm
E	17628	Blue	200 mm	120 mm	120 mm
F	17625	Red	140 mm	90 mm	80 mm
G	17626	Red	170 mm	75 mm	60 mm
H	17627	Red	190 mm	90 mm	80 mm



SPARE COWL ALONE (WITHOUT DECK PLATE)

	Ref.	Color	Matching air vent (without base)	Base and replacement cap
A	17640	Blue	16923	16929
B	17649	Blue	16926	16929
C	28865	Red	17625	16929
C	28866	Red	17627	16929
D	28868	Red	17625	16929
E	17639	Blue	16924	16930
F	17641	Blue	16922	16930

REPLACEMENT VENT

	Ref.	Matching air vent
A	28867	47823
B	31751	47824
A	31753	47825
A	31754	47827





DORADE BOX

Dorade box in rigid ABS, air handle in soft PVC. Anti-UV treated assembly. The Dorade box is delivered complete, with:

- Innersleeve.
- Innersleeve collar.
- Protective cap.
- Aeration sleeve (female).
- Cutout protection sleeve (male).

Complete Dorade box:

- Length HT: 260 mm.
- Width HT: 160 mm.
- Cutout Ø: 77 mm.
- Useful Ø Airflow: 62 mm.
- Maximum deck thickness: 40 mm.

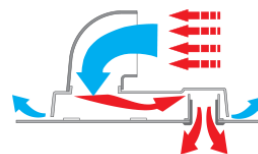

	Ref.	Color	Dimensions	Diameter	Built-in diameter	Overall diameter	Male replacement fittings	Female replacement fittings
A	11661	Red	260 mm x 160 mm	77 mm	62 mm	40 mm	16934	20394
B	11662	Red	335 mm x 200 mm	90 mm	80 mm	60 mm	16928	20306
C	16932	Blue	260 mm x 160 mm	Ø 77 mm	62 mm	77 mm	16934	20394
C	16933	Blue	335 mm x 200 mm	Ø 90 mm	80 mm	90 mm	16928	20306

COOL'N DRY DORADE BOX

Good ventilation of your boat is essential to your comfort and also to the longevity of the equipment. The Cool'n Dry dorade box keeps the ventilation inside the boat, even in bad weather.

- Continuous ventilation: when sailing, at anchor or winter storage, the windsock remains constantly open.
- No water ingress, thanks to an exclusive automatic closing system, in the event of heavy rain or a sea package.
- Manual safety closing by simple pressure with 2 fingers.
- Rugged, weatherproof construction: anti-UV PVC windsock and anti-UV ABS dorade box COOL'N DRY alone (to be adapted to existing sleeve).



Ref.	Color	Replacement fittings
47820	Blue	17641
47821	Red	28865
47822	Blue	17639
47823	Red	28867
47824	Blue	31751
47825	Red	31753
47826	Blue	31752
47827	Red	31754

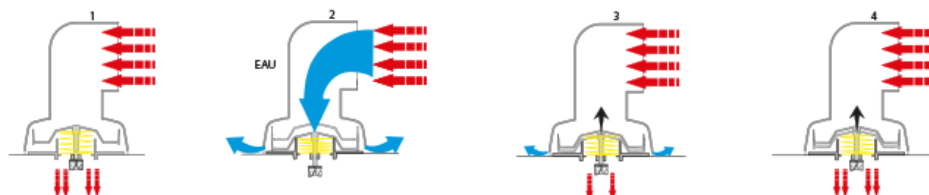
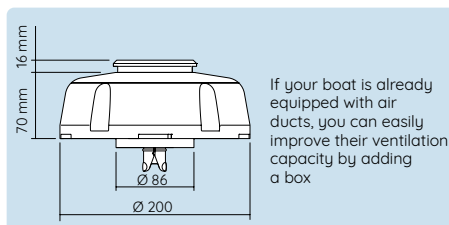

The arrival of a sea spray or heavy rain (2) temporarily closes the flap, preventing any water intrusion into the cabin.

As the water is evacuated (3), the flap lifts back up, restoring airflow.

COOL'N DRY

Ref.	Features
31392	For handle with base Ø 75 mm
31393	For handle with base Ø 100 mm

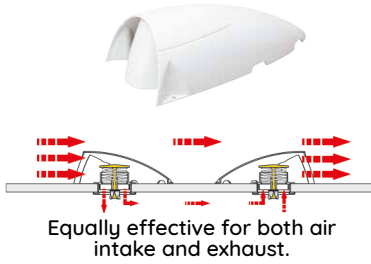

STREAMLINED DORADE BOX

Ref. 51637

Polyamide shell, shockproof and UV-resistant. Dorade opening and closing system from the inside.

Functions as both air intake and extraction. Limits accidental water ingress.

Delivered complete with:

- Dorade body.
- Closing flap.
- Sleeve Ø 85 mm.

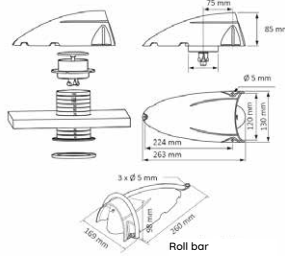
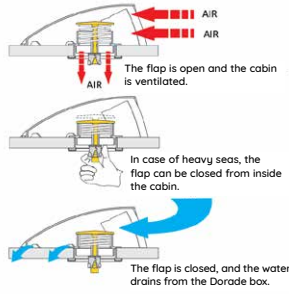

PLASTIMO

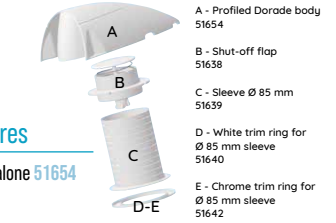

Options & accessoires

Streamline dorade cover alone 51654

Options & accessoires

Stainless steel protection hoop

REF. : 54027

Depending on the boat's configuration, a profiled dorade box may be mounted in a location where it is exposed to specific stresses (frequent passages, repeated shocks, ...). In this case, we recommend the addition of a stainless steel protective hoop.

VENTILATION SHUT-OFF UNIT

Ref. 51638

Closing flap for profiled dorade box.



PLASTIMO

WHITE FLANGE FOR ABOVE SLEEVE

Ref. 51640

Collar for profiled dorade box sleeve
Diameter: 85 mm
Color: white



PLASTIMO

SELECTED BY **PLASTIMO**

VENTS



	Ref.	Features	Base diameter	Opening diameter	Height	Width	Depth
A	400710	Adjustable, 5-hole mounting.	115 mm	120 mm	220 mm	-	-
B	400730	Adjustable, 5-hole mounting.	115 mm	120 mm	220 mm	-	-
C	415889	-	-	-	128 mm	150 mm	195 mm
D	400034	Cutout diameter 83 to 89 mm, fastened with 3 screws. Plastic collar with 25 mm high sleeve for 3" (76 mm) ventilation pipe.	-	-	57 mm	135 mm	mm

SELECTED BY **PLASTIMO**

FABRIC WINDSOCKS

These air sleeves don't change in the wind and don't produce any unpleasant whistling. Fully braided sleeves with polyester bias for excellent durability and high resistance to stress. This ensures good tensioning and wind resistance.

Ref.	Height	Lenght	Width
37996	1,95 m	450 mm	310 mm
37995	1,82 m	450 mm	450 mm





ELECTRICITY

Handheld spotlights	212
LED torchs	213

Headlamps	215
-----------------	-----



X-SPOT BUOYANT SPOTLIGHT

Ref. 67367

Extremely powerful floating spotlight, 5000 mAh battery rechargeable via micro USB. Functions as an external battery for plugging in a smartphone or other micro USB rechargeable item.

Large handle for a good grip. Adjustable stand to position the lamp according to the desired orientation of the light.

- 5 lighting modes: Strong, Strong and Wide, Maxi, Eco, Flash
- Hold for 2 seconds to switch to Flash mode.
- Autonomy 2 to 26 hours
- 85 to 1585 Lumens (depending on mode chosen).
- Range: 13 to 905 m
- Battery 5000 mAh rechargeable via micro USB (charging time : 2h30 to 3h)
- Also works on CR123 A lithium battery (not included).
- Dimensions: 171 x 153 x 103 mm (L x H x W)
- Weight: 717 g (battery included).
- Waterproofing: IP67

Delivered with battery, integrated stand and carrying strap.

The X-Spot is built to resist accidental temporary immersion (such as falling overboard or spray) but is not designed for extended or continuous immersion.





SAFETY LED TORCH LIGHT

- Super-powerful white LEDs.
- Morse code function.
- Housing covered with translucent blue rubber.
- IP44 rating sprayproof.
- Powered by 2 batteries not included.

Ref.	Number of LEDs	Lightning power	Luminous range	Burning time	Supply voltage	Length	Diameter	Weight
P203948	3	15 lm	10 m	10 h	2 x AA/LR06	150 mm	40 mm	65 g
P203949	7	25 lm	15 m	30 h	2 x D/LR20	205 mm	68 mm	165 g



LED WATERPROOF AND FLOATING TORCH

Ref. 65537

The essential on-board lamp.

- Shock-resistant.
- Floating.
- LED power 50 lumen.
- Autonomy: 25 hours.
- Beam range: 20 m.
- Dimensions: 5.5 x 5.5 x 15.5 cm.
- Power supply: 2 AA batteries (not included).
- Weight (without battery): 81 g.

SELECTED BY PLASTIMO



4-LED WATERPROOF TORCH

Ref. 51574

Ideal for diving under the hull, inspecting the propeller or the mooring.

- Waterproof to 30 m.
- Length: 14.5 cm
- Powered by 4 LR06/AA batteries, included.
- Weight (with batteries): 155 g.



WORK LIGHT

Ref. 67369

Plastimo lamp with spotlight or torch function. Tilting magnetic holder to fix the spotlight and tilt the light as required. Hanging hook.

- Magnet on the back of the spotlight.
- 200 lumens (ANSI).
- Range: 30 m.
- Autonomy: 4 h
- On/off on independent torch and spotlight.
- Dimensions: 40 x 60 x 220 mm.
- Weight: 170 g without battery.
- Batteries: 3 x AA (not included).



ALUMINUM LED TORCH

Ref. 67368

Compact and multi-purpose, this powerful Plastimo flashlight with adjustable beam offers 5 modes: High/Medium/Eco/Flash/SOS. Delivered with wrist strap.

- High mode: 500 lumens (ANSI) - Range 300 m - Autonomy 3 h.
- Eco mode: 100 lumens (ANSI) - Range 60 m - Autonomy 6 h.
- Flash mode: Flash / SOS.
- Dimensions: Ø 33 x 131 mm
- Weight: 121 g without battery.
- Batteries: 3 x AAA (not included).



A



B

HEADLIGHTS LED

Powerful and clever, each of Plastimo's headlamps and flashlights will meet your expectations whether for outdoor activities, maneuvering or reading maps at night.

- Multiple modes, white and red lighting.
- Operation with 3 AAA batteries.
- Pivoting head.

	Ref.	Model	Protection rating	Color	Luminous flux	Range	Dimensions	Option(s)	Weight
A	67420	F4	IPX4	Red White	170/80 ANSI	100/50 m	60 x 40 x 45 mm	45 °	57 g without battery
B	67366	F9	IPX5	Red White	210/20 ANSI	65/5 m	70 x 35 x 45 mm	45 °	60 g without battery



PLASTIMO

happy boating to you!

NEW HEADLAMPS

DESIGNED TO RESIST THE MOST EXTREME CONDITIONS

Powerful LEDs - Lithium battery - USB-C charging - Flash mode

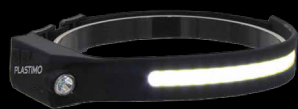

LED BAND | P203946

Very light and flexible
Motion sensor
White and red light
IP44 waterproof rating



LED COMPACT | P203947

Tiltable head, removable headband
Motion sensor
White and red light
IP44 waterproof rating



LED TORCH | P208395

Hybrid headlamp/torch
Light range up to 150 m
White light, 3 power levels
IP67 waterproof rating

Find out more at www.plastimo-pro.com



© Jean-Marie LOT

CHANDLERY

Deck equipment	218	Handrails	230
Jib reefing	219	Deck mounting hardware	231
Wires and shrouds	223	Deck hatches	232
Chainplates	225	Padlocks and latches	236
Pad eye, nut and eye bolt	227		

PROTECTIONS

Leather protection to prevent rubbing and wear caused to sails by rigging. Easy to sew onto the part of the rig to be protected, and easy to remove and put back on the following season. Offered in light gray leather, in 3 sizes and shapes, to perfectly fit the shape of stanchion heads and rope junctions.

Each kit includes:

- 2 pieces of pre-perforated light-gray leather
- 2 needles
- waxed polyester thread
- sewing instructions

Weight: 30 g



	Ref.	Model
A	2351150	Lifeline protection, Cable junction
B	2351151	Lifeline sleeve, Parafil end fitting
C	2351155	Stanchion guard

BACK SUPPORTERS



	Ref.	Model	Dimensions
A	13444	Plastic (rigid)	38 x 12 cm
B	29525	Foam	47 x 14 cm

SELECTED BY PLASTIMO



GUARDRAIL NETTING

High-strength 100% nylon diamond mesh. Knitted mesh for greater strength and no extra thickness. Reinforced top and bottom strap

- Net length: 10 m bag or 100 m spool
- Net height: 40/60 cm
- Number of meshes (vertical): 11
- Diagonal of a mesh: 55 mm

Ref.	Net length	Height
14938	Blister of 10 m	40/60 cm
14939	1 Roll = 100 meter	40/60 cm



HALYARD STOWAGE BAGS

PVC or Dralon, mesh, batten and eyelets.

Ref.	Dimensions	Model
37989	30 x 20 x 10 mm	Dralon, Royal Blue
37990	35 x 25 x 12 mm	Dralon, Royal Blue
37991	45 x 30 x 15 mm	Dralon, Royal Blue
37992	30 x 20 x 10 mm	PVC, White
37993	35 x 25 x 12 mm	PVC, White
37994	45 x 30 x 15 mm	PVC, White

PELICAN HOOK



	Ref.	Model	Cable diameter	Length	Breaking Load
A	18532	Stainless steel pelican hook + swage stud 4mm	4 mm	130 mm	1000 kg
B	415204	Wichard pelican hook 100 mm - M8 x 125 mm	8 mm	100 mm	2300 kg

JIB REEFING

The Plastimo jib reefing range stems from 50 years of expertise in high-pressure injection and composite materials engineering. Designed for 4 to 11-metre boats, our headsail reefing meets the needs of all yachtsmen, whether experienced sailors or beginners. Very easy to use and virtually maintenance free, the Plastimo jib reefing is a reliable crewmember which contributes to your sailing performance.

MADE BY PLASTIMO

Selecting your Plastimo jib reefing

Spar design : S-series or T-series ?

The **S-series** jib reefing features a single-groove spar (S for "single"). Its patented assembly system allows for very easy installation with no need to unstep the existing forestay.

The **T-series** jib reefing features a twin-groove spar (T for "twin"). It allows the use of the jib reefing on a hollow forestay when racing, or the setting of twin head sails, to avoid hoisting the spinnaker.

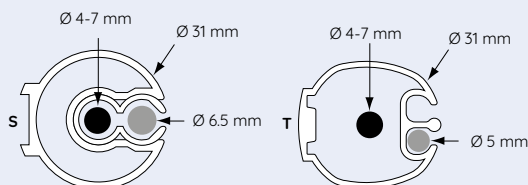

Chainplates or turnbuckle ?

- Most sailing boats are equipped with chainplates to fasten the forestay to the stem fitting. Chainplates come with several holes which facilitates the adjustment of the standing rigging. The use of chainplates also allows to position the tack point as low as possible.
- The turnbuckle version allows for more accurate rigging adjustments. However, the tack point will have to be positioned slightly higher depending on the turnbuckle size.

Which jib reefing size for my boat ?

Plastimo proposes 3 models to fit all sailboats from 4 to 11 metres. While the boat length is important, you must also consider the forestay diameter and the headsail size. For example, in the case of a 6-metre boat, the 406 model will offer the best compromise. However, if the headsail size is much larger than the maximum sail area recommended, selecting a 609 model is a better option.

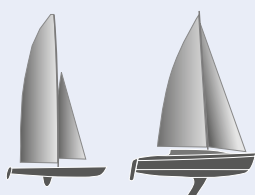

4-11 m





406 JIB REEFING

Lightweight and durable, the 406 furler benefits from the technology of larger furlers, with 2 sets of Delrin® ball bearings on the drum and swivel. All components are made of polyamide. For sailboats from 4 to 6 meters.

Ref.	Model	Forestay diameter	Delivered complete for strut	Bolt rope diameter	Max genoa size	Drum capacity
25722	406-S Chainplates	4 to 7 mm	6.35 m	6,5 mm	12 m ²	7 m Ø 5 mm
25723	406-S Turnbuckle	4-7 mm	6.45 m	6.5 mm	12 m ²	7 m Ø 5 mm
25200	406-T Chainplates	4-7 mm	6.75 m	5 mm	12 m ²	7 m Ø 5 mm
25286	406-T Turnbuckle	4-7 mm	6.85 m	5 mm	12 m ²	7 m Ø 5 mm



609 JIB REEFING

The fairing of the 609 furler can be rotated through 360° for better line guidance and increased safety. This fairing provides better protection for the drum and, thanks to its sleek design and recessed screws, presents no obstacle to rope circulation. The drum is fitted with highly resistant stainless steel and Delrin® balls. The swivel is fitted with Torlon® and Delrin® balls, which considerably enhance the furler's performance and mechanical strength. The chainplates are adjustable in width. For sailboats from 6 to 9 meters.

Ref.	Model	Forestay diameter	Delivered complete for strut	Bolt rope diameter	Max genoa size	Drum capacity
58207	609-T Chainplates	4 - 7 mm	9.40 m	6.5 mm	25 m ²	13 m Ø 6 mm
58202	609-S Chainplates	4 - 7 mm	9.55 m	6.5 mm	25 m ²	13 m Ø 6 mm
58203	609-S Turnbuckle	4 - 7 mm	8.95 m	5 mm	25 m ²	13 m Ø 6 mm
58208	609-T Turnbuckle	4 - 7 mm	9.10 m	5 mm	25 m ²	13 m Ø 6 mm



811 JIB REEFING

The fairing of the 811 reel can be rotated through 360° for improved brush guidance and increased safety. The drum core is made of high-strength aluminum combining performance and lightness. The drum and swivel are fitted with Torlon® and Delrin® balls, which considerably enhance the reel's performance and mechanical strength. Model 811 comes standard with adjustable chainplates, allowing 2 types of mounting (chainplates or rigging screw). For sailboats from 8 to 11 meters.

Ref.	Model	Forestay diameter	Delivered complete for strut	Bolt rope diameter	Max genoa size	Drum capacity
58204	811-S	4 - 7 mm	11.20 m	6,5 mm	35 m ²	17.5 m Ø 8 mm
58209	811-T	4 - 7 mm	11.40 m	5 mm	35 m ²	17.5 m Ø 8 mm





JIB REEFING SYSTEM OPTIONS

	Ref.	406-S	406-T	609-S	609-T	811-S	811-T
A	25677			V	V	V	V
	26140	V	V				
B	25720	V	V	V	V	V	V



HALYARD DIVERTER WHEEL KIT

Ref. 25720

Prevent genoa or spinnaker halyard from wrapping around the furler profile
Fits 406 S, 406 T, 609 S and 609 T, 811 S and 811 T furlers.

ST. STEEL HALYARD FEEDER

If the halyard/profile angle is less than 10°, please add:
For head or split rigging:
Base 45 x 45 mm
Halyard Ø 18 mm
Drilling 4 x Ø 4.8 mm
609-S : yes
609-T : yes
811-S : yes
811-T : yes



Ref.	Model	Features
25677	Large stainless steel halyard guide	<ul style="list-style-type: none"> • Base: 45 x 45 mm • Harness: Ø 18 mm • Hole: 4 x Ø 4.8 mm Fits rewinders 609-S, 609-T, 811-S, 811-T
26140	Small stainless steel halyard guide	<ul style="list-style-type: none"> • Base: 45 x 45 mm • Harness Ø 18 mm • Drill 4 x Ø 4.8 mm Fits 406 S and 406 T rewinders



HALF HALYARD FEEDER

	Ref.	Model
A	58245	Half halyard feeder - jib reefing 609 T
B	58250	Half halyard feeder - jib reefing 811 T



HALYARD SWIVEL FOR JIB

	Ref.	Model
A	17067	Halyard swiveling for 406s
B	58248	Swiveling jib reefing 609/811

Options and accessories

Ref.	Model
58246	M12x35 bolt + nut for furling system 609
58247	Ø12 mm pin and cotter for furling system 609
17065	Plastic slider for furling system 406-S
20321	White PVC protection for furling system
19451	Swivel shackle for furling swivel 609 and 811

DRUM

	Ref.	Model
A	10001	Drum 406 s&t
B	58244	Drum jib reefing 609
C	58249	Drum jib reefing 811

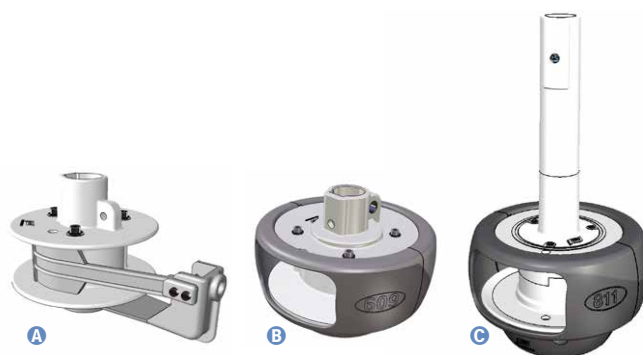

SCREW KIT

Ref.	Model
55975	Screw kit jib reefing s series
27854	Kit of screws "s" range jib reefing
55976	Screw kit jib reefing t series



ACCESSORIES KIT

Ref.	Model
55977	Accessory kit jib reefing s series
55978	Accessory kit jib reefing t series



KEY AND SCREWS KIT

	Ref.	Model
A	55979	Junction liners & screws jib reef s
B	55980	Junction liners & screws jib reef t



PROFIL

	Ref.	Model
A	22827	Upper/ lower bearing ø31 mm
B	25184	Alloy bottom spar T serie
C	25375	Coupling sleeve ø31
D	25384	Spare parts, headsail (sleeve)
E	25752	Alloy botton spar serie
F	26179	Pvc spar 1.50m serie s
F	56728	Pvc spar 1.5 m serie s (x7)

ST. STEEL RINGS

Compatible with shouldered axes.
Supplied in packs of 100 (ref. 402080, ref. 402081), packs of 50 (ref. 402082, ref. 412859), packs of 10 (ref. 402086, ref. 402087)



Ref.	Diameter	Wire diameter
402080	14 mm	1 mm
402081	16 mm	1,2 mm
402082	20 mm	1,5 mm
402086	30 mm	2 mm
402087	25 mm	1,5 mm
412859	22 mm	1,5 mm

SELECTED BY PLASTIMO



PIN 12/10

Ref. 416743

Usable length: 23 mm

Overall length: 32 mm

Wire diameter: 1.2 mm

Delivered in packs of 10

LEATHER SPREADER BOOTS

Leather for looks and resistance to the marine environment, neoprene and rubber for protection: an elegant and effective way to preserve sails by avoiding direct rubbing against spreaders.

Suitable for all spreader sizes and shapes, on headsails and mainsails: a long strap with Velcro closure allows the protection to be adapted to the rigging.

Pre-formed cover protection in leather on the outside, and neoprene on the inside for non-aggressive contact on the rigging.

Can be put on and taken off at will thanks to the velcro strap.

Gray UV-treated leather, combined with textile weave and neoprene and rubber coating.

Protectors sold in pairs.



Ref.	Type	Model
2351050	S	For 55-90 mm spreaders with continuous rigging
2351052	M	For 95-122 mm spreaders with continuous rigging / 74-95 mm spreaders with discontinuous rigging
2351054	L	For 122-154 mm spreaders with continuous rigging / 105-122 mm spreaders with discontinuous rigging
2351056	XL	For 122-154 mm spreaders with discontinuous rigging



SPREADER BOOTS

White PVC.

Prevent wear and tear on headsails by rubbing against spreader ends. Easy installation, even post rigging.

Ref.	Model	Shroud diameter
17060	10 x 30 mm - Flat spreader	4-6 mm
17062	Ø 28 mm - Round spreader or stanchion	6 mm
17061	10 x 30 mm - Flat spreader	7-12 mm
17063	Ø 30 mm - Round spreader or stanchion	9 mm
17064	Ø 50 mm - Round spreader or stanchion	12 mm
10633	Ø 53 mm - Round spreader or stanchion	19 mm





SPAR PACKAGE

Includes: 1 aluminum profile, 1 plastic profile, 1 key with screw.

Ref.	Model
26901	For model 406S, 609S, 811S
26902	For model 406T, 609T, 811T



BLOCKS AND SHEETS PACKAGE

Includes: 12.50 m of pre-stretched Ø 4 mm stock (ref. 48116), 3 pulleys (ref. 10589) for Ø 25 mm stanchion.

Ref.	Model
17069	Block & rope kit for 406
17071	Blocks & ropes kit for 608 & 809
62353	Line feeder 406 s&t

MOUNTING BRACKET

Ref.	Model
21291	Mounting bracket 609 f (x2)
21295	609 e mounting brackets (x2)
22850	Mounting plates 910s / 810 s & t (x2)
26325	Chainplates 406s/t 5 holes
21308	Mounting brackets 406 e



WIND INDICATORS

Model: TEMPEST 12"

Material: ABS and aluminum

Rotation system: Axis

Model: VIREFLEX 15"

Material: ABS and aluminum

Rotation system: Pivot on stone support : high sensitivity

Sector adjustment: Easy, adjustment template (4 possible mountings)

Arrow sensitivity adjustment: By stainless steel slider

Visibility: Reflective strips



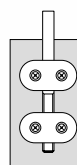

	Ref.	Model	Height	Weight	Mounting method
A	17116	Tempest dinghy wind indicator	300 mm	36 g	Lateral, on the mast
B	17117	Vireflex racing wind indicator	380 mm	104 g	Lateral or vertical

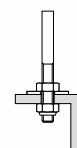

Side-mount

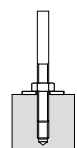

On angle-bracket



At end of mast

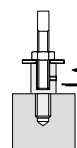

On existing support

ROUND U-BOLT

296 stainless steel chainplate with swivel padeye. Supplied in packs of 2

Ref.	Stock Ø	A	B	H	Breaking load
13752	4 mm	30 mm	24 mm	40 mm	350 kg
13753	5 mm	35 mm	34 mm	80 mm	800 kg
13754	6 mm	35 mm	34 mm	80 mm	1200 kg
13755	8 mm	35 mm	34 mm	80 mm	1400 kg
13756	8 mm	35 mm	54 mm	100 mm	1600 kg
13757	10 mm	50 mm	32 mm	90 mm	2500 kg
13758	10 mm	50 mm	67 mm	130 mm	2500 kg
13759	12 mm	60 mm	80 mm	150 mm	300 kg

PLASTIMO

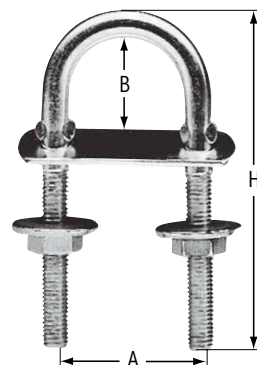

TRIANGULAR U-BOLT

Ref.	Model	Stock Ø	A	B	C	H
13760	Straight	8 mm	33 mm	40 mm	50 mm	100 mm
13761	Tilted 8	8 mm	33 mm	40 mm	50 mm	100 mm
13762	8° inclined	8 mm	33 mm	40 mm	50 mm	100 mm
13764	Straight	10 mm	40 mm	48 mm	60 mm	120 mm
13765	Tilted 8	10 mm	40 mm	48 mm	60 mm	120 mm
13766	Tilted 8	10 mm	40 mm	48 mm	60 mm	120 mm

PLASTIMO

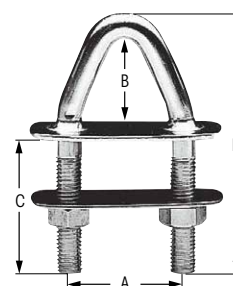

WATERTIGHT U-BOLT

- Forged 316 L stainless steel.
- UV-resistant black rubber base ensures perfect watertightness.
- Aesthetic solution.
- Delivered with nuts and counterplate.
- Registered design - French manufacture.

Ref.	Stock Ø	A	B	C	H	SWL: Safe Working Load	Break load
470033	5 mm	28 mm	21 mm	30 mm	60 mm	400 kg	2000 kg
410181	6 mm	32 mm	24 mm	35 mm	70 mm	600 kg	3000 kg
410199	8 mm	36 mm	25 mm	40 mm	80 mm	960 kg	4800 kg
410208	10 mm	40 mm	26 mm	45 mm	90 mm	1400 kg	7000 kg
410223	12 mm	44 mm	27 mm	50 mm	110 mm	2000 kg	10000 kg
410188	6 mm	32 mm	24 mm	55 mm	90 mm	600 kg	3000 kg
410204	8 mm	36 mm	25 mm	60 mm	100 mm	960 kg	4800 kg
410220	10 mm	40 mm	26 mm	65 mm	110 mm	1400 kg	7000 kg
410227	12 mm	44 mm	27 mm	70 mm	130 mm	2000 kg	10000 kg

Wichard





FOLDING PAD EYES

- Hot-forged 316 L stainless steel.
- Remarkable strength ensuring high operating loads, in all positions.
- Small footprint in folded position.
- Silicone locking pad to dampen noise and vibration.
- Registered design - French manufacture. Simple, 3-point base ISO 15085 compliant, recommended for lifelines and harness anchor points



	Ref.	Stock Ø	Model	A	B	H
	403719	6 mm	Double	45 mm	27 mm	
A	470031	8 mm	Double	59 mm	35 mm	
	402356	10 mm	Double	75 mm	45 mm	
	402332	6 mm	Single, 3-point secured base	44 mm	27 mm	15 mm
B	402333	8 mm	Single, 3-point secured base	59 mm	35 mm	18 mm
	402334	10 mm	Single, 3-point secured base	80 mm	45 mm	25 mm
C	403917	6 mm	Single, universal base	40 mm	23,4 mm	15 mm

U-BOLT

Half-round caddy in 316 L stainless steel. Supplied with 2 plates and 2 nuts.

Ref.	Stock Ø	A	B	C	H	Working load	Breaking load
410155	4 mm	24 mm	21 mm	27 mm	50 mm	480 kg	1000 kg
403871	5 mm	28 mm	24 mm	30 mm	60 mm	640 kg	2000 kg
403879	6 mm	32 mm	27 mm	35 mm	70 mm	1280 kg	3000 kg
410157	6 mm	32 mm	27 mm	55 mm	90 mm	1280 kg	3000 kg
403880	8 mm	36 mm	30 mm	40 mm	80 mm	2400 kg	4800 kg
410158	8 mm	36 mm	30 mm	60 mm	100 mm	2400 kg	4800 kg
403881	10 mm	40 mm	32 mm	45 mm	90 mm	3600 kg	7000 kg
410159	10 mm	40 mm	32 mm	65 mm	110 mm	3600 kg	7000 kg
410156	12 mm	44 mm	34 mm	50 mm	110 mm	6400 kg	10000 kg
410180	12 mm	44 mm	34 mm	70 mm	130 mm	6400 kg	10000 kg

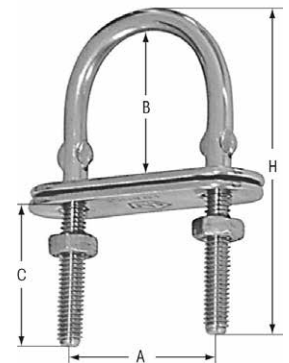

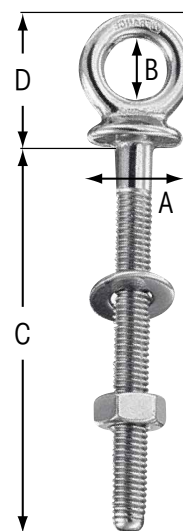

EYE NUT & EYE BOLT

316L stainless steel eye bolt, drop-forged in a single piece for extra secure fastening. Supplied in packs of 10 (Refs. 402466, 402467, 402469) and packs of 5 (Refs. 402473, 402474)

Ref.	Wire diameter	A	B	C	D	Thread	Breaking Load
402466	5 mm	17 mm	12 mm	40 mm	25 mm	M6 x 100	900 kg
402467	5 mm	17 mm	12 mm	60 mm	25 mm	M6 x 100	900 kg
402469	6 mm	20 mm	14 mm	80 mm	6 mm	M8 x 125	1500 kg
402473	7 mm	25 mm	16 mm	100 mm	36 mm	M10 x 150	2700 kg
402474	8 mm	28 mm	18 mm	120 mm	41 mm	M12 x 175	3500 kg

FEMALE EYE NUT 316 STAINLESS STEEL.

Delivered in packs of 10 (411867, 411868, 411869, 411870) and packs of 5 (411872, 411874, 411876)

Ref.	Wire diameter	A	B	D	Breaking Load
411867	6 mm	17 mm	13 mm	6 mm	1500 kg
411868	6 mm	17 mm	13 mm	6 mm	2200 kg
411869	8 mm	22 mm	17 mm	8 mm	3000 kg
411870	8 mm	22 mm	17 mm	8 mm	4500 kg
411872	10 mm	28 mm	22 mm	10 mm	4800 kg
411874	12 mm	34 mm	27 mm	12 mm	7000 kg
411876	12 mm	34 mm	27 mm	56 mm	10000 kg

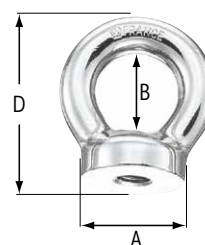

FEMALE EYE NUT 316 STAINLESS STEEL.

Delivered in packs of 4 (ref. 13992) and packs of 2 (refs. 13993, 13994, 13995).

Ref.	Wire diameter	B
13992	6 mm	16 mm
13993	8 mm	20 mm
13994	10 mm	25 mm
13995	12 mm	30 mm

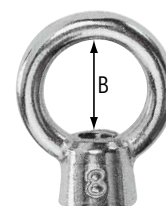



TRANSOM PINTLES

Stainless steel needle

Ref.	Model	Rod diameter	Weight
16937	Stainless steel pintle, usable length 30 mm	8 mm	52 g
16938	Stainless steel pintle, usable length 40 mm	8 mm	60 g

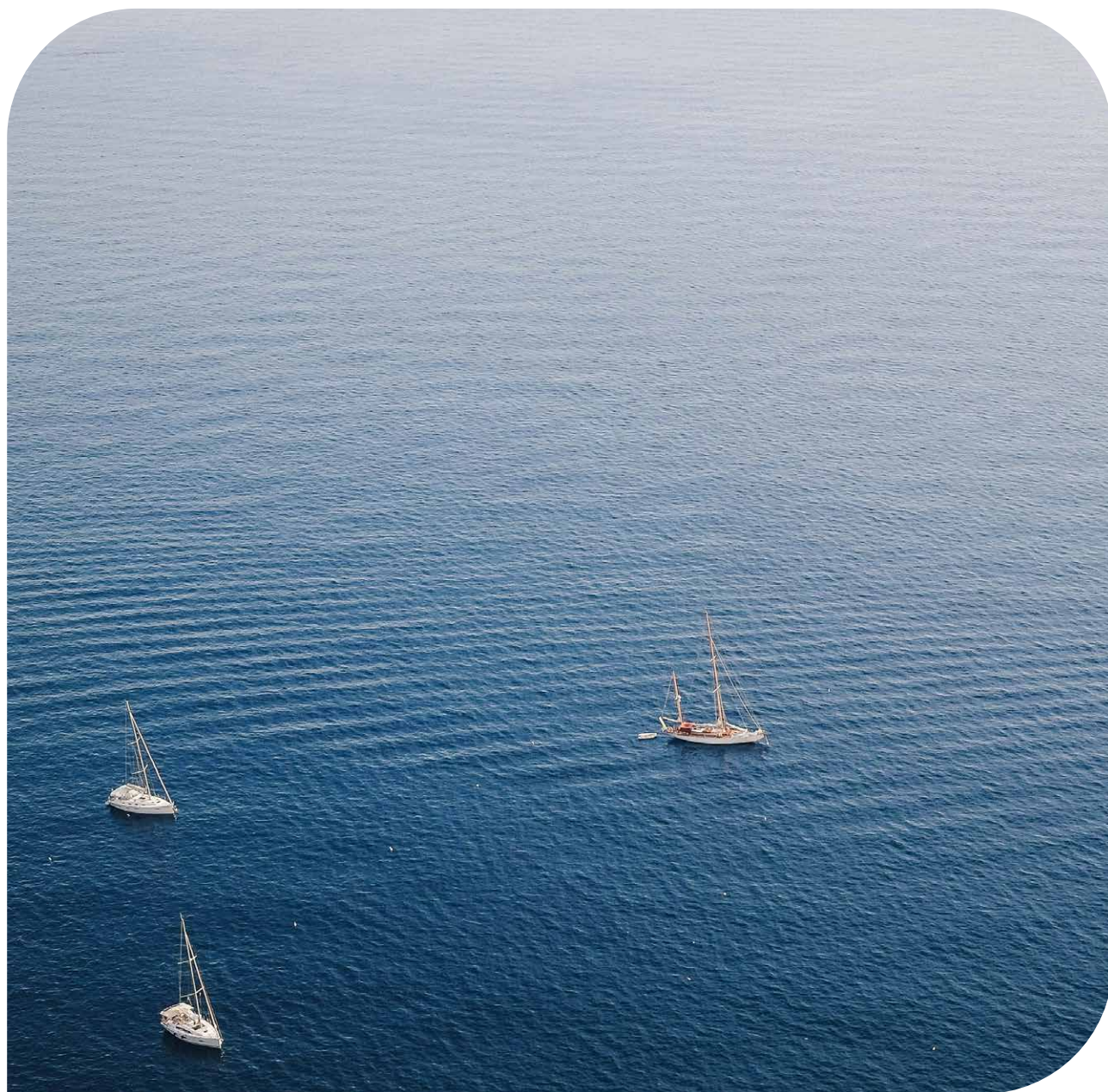

SELECTED BY PLASTIMO



PAD-EYE PLATES

	Ref.	Material	Plates dimensions	Height	Width	Mounting	Stock Ø
	408463	Stainless steel 304	35 x 30 mm	15 mm	15 mm	4 holes	5 mm
A	408462	Stainless steel 304	40 x 35 mm	17 mm	18 mm	4 holes	6 mm
	408750	Stainless steel 304	50 x 40 mm	20 mm	21 mm	4 holes	8 mm
B	401450	Brass chrome plated	50 x 30 mm	12 mm		3 holes	6 mm

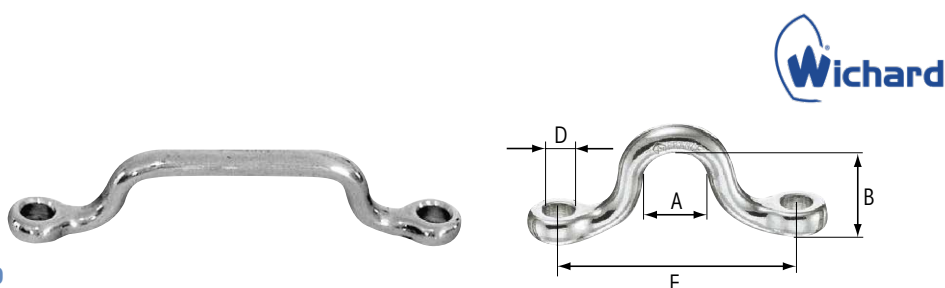

316 L ST. STEEL EYE STRAP

Livré par lot de 10

Ref.	Model	A	B	D	E	Breaking load
415206	Standard	8 mm	10 mm	4 mm	32 mm	650 kg
100739	Standard	10 mm	14 mm	5 mm	37,5 mm	1800 kg
415208	Standard	12 mm	16 mm	6 mm	45 mm	2400 kg
415209	Standard	16 mm	21 mm	8 mm	60 mm	3500 kg
419073	For strap	28 mm	5 mm	4 mm	56 mm	
419074	For strap	34 mm	10 mm	5 mm	65 mm	

EYE BOLT POLISHED AISI 316 STAINLESS STEEL.

Ref.	Stock Ø	A	B	C	D	Thread	Breaking load
13747	5 mm	25 mm	13 mm	50 mm	26 mm	M6	1200 kg
13748	5 mm	25 mm	13 mm	100 mm	26 mm	M6	1200 kg
13749	6 mm	25 mm	15 mm	50 mm	30 mm	M8	2200 kg
13750	7 mm	30 mm	16 mm	50 mm	35 mm	M10	3500 kg
13751	7 mm	30 mm	16 mm	100 mm	35 mm	M10	3500 kg
16791	5 mm	25 mm	13 mm	40 mm	26 mm	M6	1200 kg
16792	5 mm	25 mm	13 mm	60 mm	27 mm	M6	1200 kg
16793	6 mm	25 mm	15 mm	80 mm	30 mm	M8	2200 kg
16794	6 mm	25 mm	15 mm	100 mm	30 mm	M8	2200 kg
27012	5 mm	25 mm	13 mm	30 mm	27 mm	M6	1200 kg
27013	6 mm	25 mm	15 mm	35 mm	31 mm	M8	2200 kg
27014	9 mm	30 mm	18 mm	100 mm	40 mm	M12	4500 kg

PLASTIMO

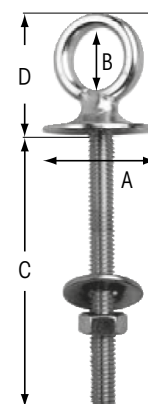

SELECTED BY PLASTIMO

ADD-ON TOP STEP

Ref. 12572

Length: 25 cm
Useful depth 150 mm.
Can also be used as a rung.



HANDRAIL HOLDER

Chromium-plated brass Ø 20mm, height 43mm



Ref.	Model
400225	Deck fitting base
400226	Cable run



Ø 25 MM ST. STEEL TUBE IN LEATHER SHEATH

Ref.	Model
106859	Stainless steel hand rail hole spacing ø280mm leather
106860	Stainless steel hand rail hole spacing ø380mm leather
106861	Stainless steel hand rail hole spacing ø430mm leather
106862	Stainless steel hand rail hole spacing ø585mm leather



Ø 26 X 20 MM OVAL ST. STEEL TUBE

Useful depth 45 mm.
316 stainless steel.

Ref.	Model
105045	Stainless steel hand rail hole spacing 200mm
105046	Stainless steel hand rail hole spacing 280mm
105047	Stainless steel hand rail hole spacing 380mm
105048	Stainless steel hand rail hole spacing 430mm
105049	Stainless steel hand rail hole spacing 585mm
106028	Stainless steel hand rail hole spacing 700 mm



Ø 24 X 20 MM OVAL ST. STEEL TUBE

Usable depth 45 mm.

Ref.	Model
10310	20 cm
10311	30 cm
10312	50.5 cm
10313	80 cm



POLYURETHANE TRANSPARENT WEAR PAD

Ref. 65399

Transparent PUR (polyurethane) patch, protects deck and gelcoat from chafing exerted by ropes and pulleys. High-performance, immersion-resistant 3M adhesive backing. Very flexible, patch can be cut to fit perfectly on flat, rounded or curved surfaces. Dimensions: 208 x 98 mm.



STAINLESS STEEL RUBBING STRAKES

An elegant solution for protection against ragging (maneuvers, mooring lines).

Ref.	Length	Width	Hole CTC distance
105041	203 mm	19 mm	124 mm
105042	304 mm	19 mm	115 mm
105043	457 mm	19 mm	118 mm
105044	610 mm	19 mm	133 mm



MULTI-PURPOSE HOLDER PLASTICLIP

Compasses, safety equipment or even fenders - all equipment that needs to be correctly attached to a boat to limit clutter and facilitate safe movement. Plastimo has developed a clamp which, from the same basic elements, enables products as varied as a compass, a reversing light or even a horseshoe buoy to be attached.. The Plasticlip offers many advantages:

- Simple, clean and fast assembly: installing the Plasticlip requires no drilling. You can change the location of your equipment at any time without damaging your boat.
- The Plasticlip adapts to several tube diameters (from 18.5 to 25.5 mm). It can be mounted on a vertical tube (stanchion, balcony) or on a horizontal tube (balcony).

	Ref.	Model
A	37030	Multi purpose bracket black
B	37031	Multi purpose bracket
C	37032	Multi purpose bracket grey
D	37034	Plasticlip holder
E	29641	Black Plasticlip M&F Base Kit

SELECTED BY PLASTIMO



WINCH HANDLE POCKETS

Crank cases in ivory-white synthetic canvas, openwork mesh-style or soft white PVC, UV-treated.

	Ref.	Model	Dimensions
A	29457	Ivory-white synthetic fabric, openwork mesh pattern: 1 crank handle	300 x 100 x 60 mm
B	10624	Soft white PVC, UV-resistant	260 x 80 x 55 mm
B	16920	Soft white PVC, UV-resistant	265 x 73 x 73 mm
B	16921	Soft white PVC, UV-resistant	275 x 73 x 50 mm
C	10625	Soft white PVC, UV-resistant	320 x 55 x 30 mm



ALUMINUM PORTLIGHTS

- Satin-finish aluminum.
- Gray-finish glass, thickness 10 or 15 mm.
- Perfect tightness with its heavy-duty one-piece frame and double-contact seal.
- One model covers a wide range of thicknesses to be clamped: 5 to 33 mm.
- Optimum visibility thanks to handle set back from glass (2 handles on T.04 ref. 63898).

Navigation: inshore or offshore

Features: sleek design, wide opening clearances

Portlight lid: glass

Frame: profile

Mounting: frame and counterplate mounted inside

Implantation on board/regulatory CE zone : IIb, III & IV Deck, roof and cockpit zones

European standard CE 94/25 of June 16, 1996:

Zone I: hull above waterline

Zone II: deck, roof, cockpit, transom

Zone IIb: hull area not belonging to zone I

Zone III: superstructure, deck and cockpit

Zone IV: cockpit and deck, aft faces of superstructure.

Easy assembly

Instinctive reversible counter-frame to cover a wide range of thicknesses to be clamped: 5 to 33 mm.

Tapping for øM4 Screws (not supplied).

Closing system

Plastimo portholes feature adjustable-friction hinges.

The double handle distributes pressure all around the seal, guaranteeing a better seal.

	Ref.	Model	Type	External dimensions	Internal dimensions	Cut-out dimensions	Weight	Glass thickness
	63894	00	Rectangular	325 x 178 mm / 12.8 x 7 in.	301 x 154 mm / 11.8 x 6 in.	303 x 156 mm / 11.9 x 6.1 in.	1.8 kg	10 mm
	63895	01	Rectangular	369 x 193 mm / 14.5 x 7.6 in.	345 x 169 mm / 13.6 x 6.6 in.	347 x 171 mm / 13.7 x 6.7 in.	1.2 kg	10 mm
A	63896	02	Rectangular	427 x 178 mm / 16.8 x 7 in.	403 x 154 mm / 15.8 x 6 in.	405 x 156 mm / 15.9 x 6.1 in.	2.56 kg	10 mm
	63897	03	Rectangular	451 x 193 mm / 17.8 x 7.6 in.	427 x 169 mm / 16.8 x 6.6 in.	429 x 171 mm / 16.9 x 6.7 in.	2.7 kg	10 mm
	63898	04	Rectangular	649 x 193 mm / 25.6 x 7.6 in.	625 x 169 mm / 24.6 x 6.6 in.	627 x 171 mm / 24.7 x 6.7 in.	3.48 kg	10 mm
B	63899	05	Rectangular	451 x 266 mm / 17.8 x 10.5 in.	427 x 242 mm / 16.8 x 9.5 in.	429 x 244 mm / 16.9 x 9.6 in.	3.4 kg	10 mm
A	63901	50	Rectangular	369 x 273 mm / 14.5 x 10.7 in.	345 x 249 mm / 13.6 x 9.8 in.	347 x 251 mm / 13.7 x 9.9 in.	3 kg	10 mm
C	63900	32	Oval	397 x 197 mm / 15.6 x 7.8 in.	373 x 173 mm / 14.7 x 6.8 in.	375 x 175 mm / 14.8 x 6.9 in.	2 kg	10 mm



Sizes 44, 60, and 70 are certified for use on survival hatches (Zone 2b).

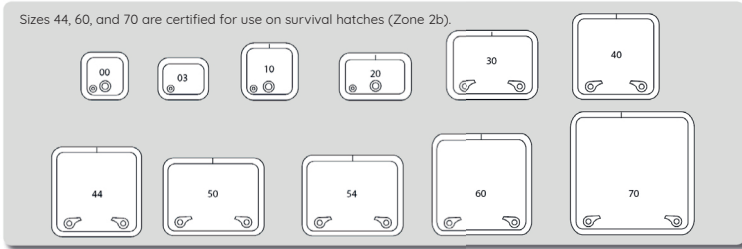

ALUMINIUM / ACRYLIC DECK HATCH

The Plastimo panel range combines optimum waterproofing, ease of assembly and aesthetics:

- Satin-finish aluminum and gray acrylic glass,
- Invisible hinges,
- Heavy-section, single-body aluminum Portlight lid ensuring high rigidity,
- Low-height Portlight lid, up to 19 mm for teak decks.

Closing system

The ergonomic shape of the handles ensures a comfortable space for a good grip. They incorporate a locking catch to prevent access from the outside. No external locking system is required.

All models feature adjustable compasses.

Adjustable opening by disengaging the compass in a jiffy.

Aluminum hinges.

Navigation: Coastal or offshore

Features: Flat profile, compass opening

Opening : Profiled

Dormer: Profiled

Mounting: Screw-on

Board layout/regulatory CE zone: II, III & IV, deck, roof and cockpit zones

European standard CE 94/25 of June 16, 1996:

Zone I: hull above the waterline

Zone II: deck, roof, cockpit, transom

Zone IIb : hull area not belonging to zone I

Zone III: superstructure, deck and cockpit

Zone IV: cockpit and deck, aft faces of superstructure

Sizes 44, 60 and 70 are approved for use as escape hatches (zone 2b).

The sizes offered are standards commonly used on production boats.

- Ice thickness 10 mm
- Telescopic compass
- Aluminum hinges
- Height recessed below deck: 15 mm
- Rayon 42.5 mm (1.7").

Panels must be attached to a flat surface with a tolerance of ± 1 mm.

Ref.	Model	External dimensions	Internal dimensions	Cut-out dimensions	Weight
63881	0	271 x 271 mm / 10.7 x 10.7 in.	209 x 209 mm / 8.2 x 8.2 in.	211 x 211 mm / 8.3 x 8.3 in.	2.1 kg
63882	3	291 x 236 mm / 11.5 x 9.3 in.	229 x 174 mm / 9 x 6.8 in.	231 x 176 mm / 9.1 x 6.9 in.	2.2 kg
63883	10	320 x 320 mm / 12.6 x 12.6 in.	258 x 258 mm / 10.1 x 10.1 in.	260 x 260 mm / 10.2 x 10.2 in.	2.7 kg
63884	20	407 x 262 mm / 16 x 10.3 in.	345 x 200 mm / 13.6 x 7.9 in.	347 x 202 mm / 13.7 x 8 in.	3.1 kg
63886	30	517 x 387 mm / 20.4 x 15.2 in.	455 x 325 mm / 17.9 x 12.8 in.	457 x 327 mm / 18 x 12.9 in.	5.2 kg
63887	40	481 x 481 mm / 18.9 x 18.9 in.	419 x 419 mm / 16.5 x 16.5 in.	421 x 421 mm / 16.6 x 16.6 in.	5.8 kg
63888	44	502 x 502 mm / 19.8 x 19.8 in.	440 x 440 mm / 17.3 x 17.3 in.	442 x 442 mm / 17.4 x 17.4 in.	6.3 kg
63889	50	567 x 437 mm / 22.3 x 17.2 in.	505 x 375 mm / 19.9 x 14.7 in.	507 x 377 mm / 20 x 14.8 in.	5 kg
63890	54	567 x 452 mm / 22.3 x 17.8 in.	505 x 390 mm / 19.9 x 15.3 in.	507 x 392 mm / 20 x 15.4 in.	6.8 kg
63891	60	567 x 567 mm / 22.3 x 22.3 in.	505 x 505 mm / 19.9 x 19.9 in.	507 x 507 mm / 20 x 20 in.	7.4 kg
63893	70	687 x 687 mm / 27 x 27 in.	625 x 625 mm / 24.6 x 24.6 in.	627 x 627 mm / 25 x 25 in.	10.2 kg

ACCESS AND STORAGE HATCHES

Developed by Plastimo's R&D team, a range of hatches that combines ease of implementation for the builder and optimized space for the user.

CE

2 years warranty



Optional locks



Opening 180° or removable hood



Removable hood, ideal when the available height doesn't allow the hood to open vertically: thanks to the special hinge, from 5° of opening, the hatch door disengages completely from its hinge.

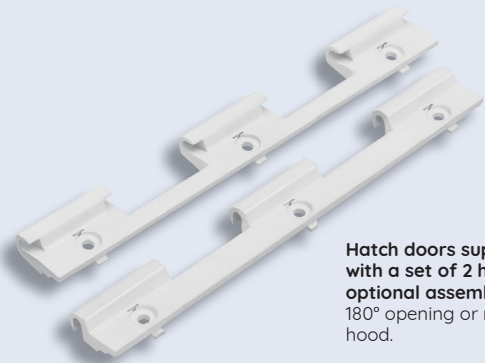

Hatch doors supplied with a set of 2 hinges for optional assembly: classic 180° opening or removable hood.

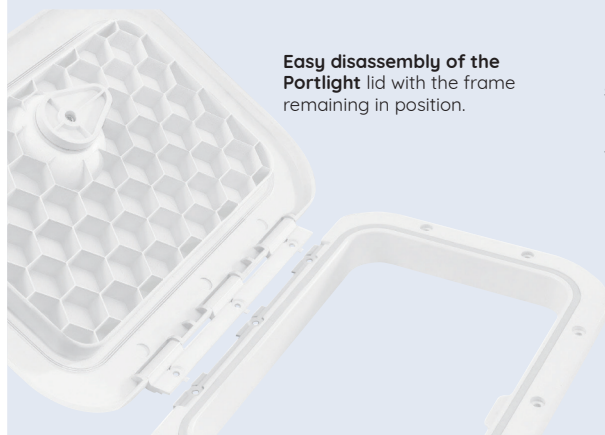

Easy disassembly of the Portlight lid with the frame remaining in position.

Exclusive honeycomb structure inside the Portlight lid, for optimum rigidity. The hatch supports the weight of a 130 kg person without any mechanical deformation.



Plastimo listens to builders and maintenance sites

With the two types of hinges supplied as standard, Plastimo offers you two mounting possibilities depending on the configuration encountered:

- Available height: cover opens 180°.
- Restricted height: cover completely removable horizontally. Easy maintenance: when replacing the cover, the hinge allows the cover to be unclipped, eliminating the need to replace the frame (with all the handling and sealing work this entails).

ISO 12216

Hatch certified for Zone IIa, A, B, C and D installation on sailboats and motorboats. Cutting dimensions & drilling templates on www.plastimo.com



ACCESS & STORAGE HATCHES

Manufactured from top-quality ASA, guaranteeing long-lasting color and consistent quality over time:

- Unaffected by UV.
- Excellent mechanical strength, enhanced by the honeycomb structure of the Portlight lid.
- Tramp-resistant / treadable: up to 130 kg load without deformation.
- 180° opening.
- Flat deck or bulkhead mounting.
- EPDM rubber seal for perfect watertightness.
- Delivered with a set of 2 hinges for a choice of mounting: classic articulated hinge for 180° opening or hinge allowing a fully removable cover.
- With optional lock.

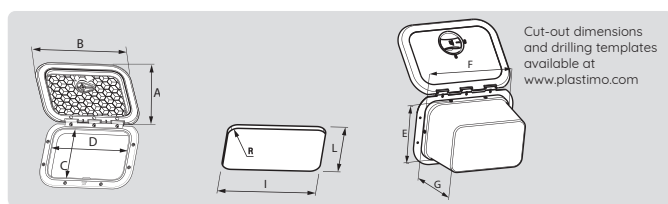

Model	Dimensions	C	D	E	F	G	Cut-out L x I - R	Handle(s)	Color		
									White	Grey	Black
Hatca	270 x 373 mm	187 mm	290 mm	197 mm	300 mm	-	202 x 305 - 42 mm	x1	62104	64790	-
				300 mm	300 mm	-	202 x 305 - 42 mm	x1	-	-	64806
	373 x 373 mm	290 mm	290 mm	307 mm	307 mm	260 mm	315 x 315 - 47 mm	x1	62112	64786	64802
				307 mm	307 mm	260 mm	315 x 315 - 47 mm	x1	-	64788	-
	315 x 440 mm	231 mm	356 mm	241 mm	366 mm	-	247 x 372 - 42 mm	x2	65889	66525	66526
	243 x 606 mm	160 mm	523 mm	170 mm	533 mm	-	175 x 538 - 42 mm	x2	65888	66523	66524
357 x 606 mm	274 mm	523 mm	284 mm	533 mm	-	289 x 538 - 42 mm	x2	62108	64794	64810	
458 x 513 mm	375 mm	430 mm	385 mm	440 mm	-	390 x 445 - 42 mm	x2	62116	64798	64814	
Hatch + storage	270 x 373 mm	187 mm	290 mm	204 mm	307 mm	190 mm	212 x 312 - 43,5 mm	x1	62106	64792	64808
	373 x 373 mm	290 mm	290 mm	307 mm	307 mm	260 mm	315 x 315 - 47 mm	x1	62114	-	64804
	357 x 606 mm	274 mm	523 mm	291 mm	540 mm	300 mm	295 x 545 - 42,5 mm	x2	62110	64796	64812
	458 x 513 mm	375 mm	430 mm	392 mm	447 mm	450 mm	400 x 455 - 47 mm	x2	62118	64800	64816



LOCKING KIT

	Ref.	Color
A	65388	White
B	65389	Black
C	65390	Grey



	Ref.	Model
A	44197	White handle for access and storage hatch
B	44206	Handle for hatch
C	44813	Lock and keys for hatch

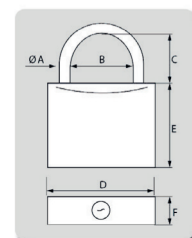

BRASS PADLOCKS

Delivered in packs of 12 and individually (Ref. P202143)

Ref.	Hasp	Ø A	B	C	D	E	F
27322	Standard	4 mm	17 mm	17 mm	30 mm	25 mm	11 mm
17577	Standard	6 mm	16 mm	19 mm	35 mm	27 mm	12 mm
17578	Standard	6 mm	20 mm	21 mm	40 mm	30 mm	12 mm
17579	Standard	6 mm	25 mm	24 mm	45 mm	32 mm	13 mm
17580	Long	6 mm	20 mm	94 mm	40 mm	30 mm	12 mm
17583	Long	6 mm	20 mm	144 mm	40 mm	30 mm	12 mm
P202143	Standard			27 mm		50 mm	

KEYED ALIKE PADLOCKS

A set of padlocks opening with the same key.

Ref.	Model	Ø A	B	C	D	E	F
29447	A set of padlocks opening with the same key.	4 mm	17 mm	17 mm	30 mm	25 mm	11 mm
17581	A set of padlocks opening with the same key.	6 mm	20 mm	21 mm	40 mm	30 mm	12 mm
17582	Set of 5 padlocks opening with the same key.	6 mm	20 mm	21 mm	40 mm	30 mm	12 mm

PLASTIMO STAINLESS STEEL PADLOCK

316 stainless steel handle



Ref.	Model	Length	Shackle height	Packaging
P203967	Standard	30 mm	16 mm	1
P203968	Standard	40 mm	22 mm	1
P203969	Standard	50 mm	28 mm	1
P203970	Standard keyed alike	30 mm	16 mm	3
P203971	Standard keyed alike	40 mm	22 mm	3
P203972	Standard keyed alike	30 mm	16 mm	5
P203973	Long shackle	40 mm	150 mm	1
P203974	Combination padlock	49 mm	13 mm	1
P203975	Long shackle	30 mm	47 mm	1
P203976	Long shackle	40 mm	50 mm	1





© Jean-Marie LIOT

ENGINE ENVIRONMENT

Marine engine accessories	239	Outboard motor bracket	250
Fuel system	239	Boat covers	251
Ventilation	244		

CROSSEVEN



JERRYCANS

Available in 5, 10 and 20 litre sizes, Crosseven jerry cans offer optimum resistance to impact, UV rays and fuel.

In standard or heavy-duty versions, they are approved for the transport of hydrocarbons and designed for intensive use on board.



SELECTED BY PLASTIMO



KILL CORD FOR OUTBOARD ENGINE

Ref. 27296

Dashboard-mounted switch box. Spiral cord and stainless steel snap hook. Shuts off the ignition as soon as the cord is pulled. In the event of a man overboard, the engine is restarted simply by operating the switch.

CROSSEVEN



UNIVERSAL KIT OF IGNITION CUT-OFF KEY

Ref. P204034

Safety leash 1.6 m x ø3.5 mm:

- Stainless steel sleeve
- Plastic snap hook
- Keys:
 - 1- Yamaha ø7.8 mm
 - 2- Kawasaki ø11.8 mm
 - 3- Mercury ø9.7 mm
 - 4- Old Suzuki Johnson ø6.5 mm
 - 5- OMC Johnson Evinrude ø10 mm
 - 6- OMC Johnson Evinrude ø7.9 mm
 - 7- Tohatsu ø12.5 mm
 - 8- New Honda ø13.5 mm
 - 9- Old Honda OMC ø9.3 mm
 - 10- Yamaha ø9.7 mm
 - 11- Yamaha ø10 mm

FUEL TANKS

Made of polyethylene. Direct fuel level reading on 24- and 29-liter models. Delivered with engine feed nozzle and vented cap.



Ref.	Capacity	Width	Length	Height
P204864	12 L	170 mm	280 mm	400 mm
P204865	24 L	230 mm	340 mm	460 mm
P204866	29 L	230 mm	365 mm	510 mm

SAFETY

WATER ON BOARD

MOORING

NAVIGATION

COMFORT

ELECTRICITY

CHANDLERY

ENGINE ENVIRONMENT

CROSSEVEN 

PLASTIC FUEL JERRYCANS

Ideal for refueling your boat. Made of high-density polyethylene. Angled spout integrated into cap. For gasoline and diesel. Approved for hydrocarbon transport. UN standard.

Ref.	Capacity	Width	Length	Height
P203061	5 L	130 mm	260 mm	250 mm
P203062	10 L	165 mm	295 mm	345 mm
P203063	20 L	185 mm	330 mm	480 mm

CROSSEVEN 

JERRYCANS WITH SPOUT

Ref.	Capacity	Width	Length	Height
P204973	5L	180 mm	175 mm	315 mm
P204974	10L	310 mm	160 mm	325 mm
P204975	20L	360 mm	205 mm	410 mm



PLASTIMO
happy boating to you!

SPARE PARTS 

FIND SPARE PARTS FOR ALL OUR PRODUCTS

WWW.BOATPARTSDISTRIBUTION.COM



FUNNELS

3 models of standard or anti-roll funnels.
With filter.

	Ref.	Model	Description
A	403795	Anti-rolling funnel	Anti-rolling funnel. Comes with 2 spouts. With filter. Dimensions inside bowl: Ø 16 cm.
B	27480	Anti-rolling funnel	Anti-rolling funnel Translucent plastic. With filter. Dimensions inside bowl : Ø 18cm.
C	37350	Optional flexible spout	Length : 280 mm For funnel ref. 27480 Conditioning : 5



NON-RETURN VALVE FOR FUEL TANK VENT

EXCLUSIVE: for Ø 25 and 38 mm vent pipe (when all valves on the market are designed for Ø 16 mm pipe).

Features:

- Material with specific treatment for flame resistance. Certification: complies with SAE J1527 standard, ISO 10088, ISO 7840, USCG.
- Non-return valve system to be fitted to the vent pipe in accordance with the recommendations of the above-mentioned standards.
- Designed for large tanks generating a large air flow, it provides an effective vent function on these large tanks which can use filling guns with a flow rate of 100 to 120 L/min.
- A ball acts as a float that closes the valve when the fuel reaches the level.
- Designed by Plastimo R & D to meet the needs of manufacturers: the Ø 25 mm non-return valve is a simple, economical solution that avoids fitting several Ø 16 mm valves in parallel, with all the associated handling and costly anti-fire accessories.

	Ref.	Model	Description
A	67232	Straight	For Ø 25 and 38 mm pipe vents
B	67435	90° elbow	For Ø 25 mm pipe vent .Can be integrated directly on tank



PLASTIC VENTS

	Ref.	Model	Hole diameter	A	B	C	D	E	F
A	62145	Round	34 mm	16-19 mm	41 mm	84 mm	43 mm	40 mm	
B	62146	Round	34 mm	16-19 mm	41 mm	68 mm	43 mm	40 mm	59 mm
C	62141	Oval	34 mm	16-19 mm	41 mm	84 mm	63 x 43 mm	40 mm	
D	62084	Oval		25 mm	29 mm	83 mm	41 x 60 mm	40 mm	
E	62085	Round		25 mm	29 mm	83 mm	41 mm	40 mm	



PLASTIC VENTS, METAL FINISH

	Ref.	Model	Hole diameter	A	B	C	D	E	F
A	62147	Round	34 mm	16-19 mm	41 mm	84 mm	43 mm	40 mm	
B	62148	Round	34 mm	16-19 mm	41 mm	68 mm	73 mm	40 mm	59 mm
C	62143	Oval	34 mm	17-19 mm	41 mm	84 mm	63 x 43 mm	40 mm	
D	62144	Oval	34 mm	17-19 mm	41 mm	68 mm	64 x 43 mm	40 mm	59 mm

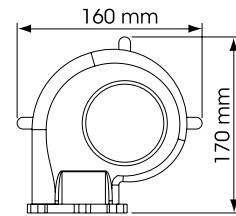
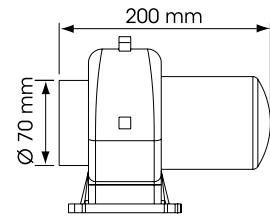

GOOD TO KNOW

How to choose your bilge blower?
Bulkhead-mounted: offers the best performance for complex installations with multiple bends.
In-line: the simplest and most economical option, ideal for short, straight installations without bends.
It can operate for longer periods than other models while consuming less power.

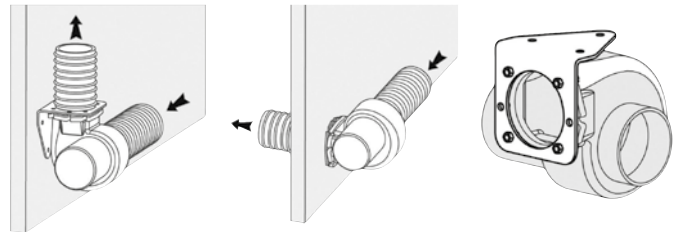

CLASSIC ELECTRIC BLOWER

Selected by many shipyards for its very robust construction and long service life. Suitable for engine hold ventilation as well as cabin ventilation, especially in wet rooms. In the engine hold: it's important to start the fan 5 minutes before starting the boat's engine. Compact in shape, it can be mounted in a variety of positions, even in confined spaces, on or through a bulkhead, horizontally or vertically. An optional mounting flange allows the fan to be adapted to any mounting configuration. Motor fairing in high-impact polyamide. All Ø 70 mm pipe grilles are suitable. ISO 8846 (explosion-proof motor)
ISO 9097 (electric fan)

Ref.	Voltage	Maximum flow	Consumption
16274	12 V	150 m ³ /h	4 A
16275	24 V	150 m ³ /h	2 A

Accessories for classic blower

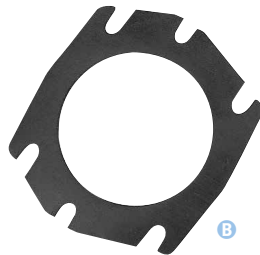
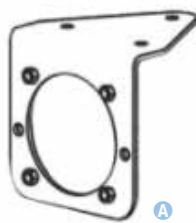

	Ref.	Description
A	57287	Fastening flange for Plastimo styleic bilge ventilator
B	17642	Damper seal EP3 fan
C	16276	Sleeve Ø 70 mm 125 x 125 mm

An aerial photograph of a harbor with deep blue water. A large boat is moving from the top towards the bottom, leaving a wide, white, frothy wake. Numerous smaller sailboats and motorboats are scattered throughout the harbor, some with their sails up. The overall scene is peaceful and scenic.

PLASTIMO

happy boating to you!

ENGINE ENVIRONMENT

PLASTIMO: THE EXPERTISE OF A LEADING PARTNER

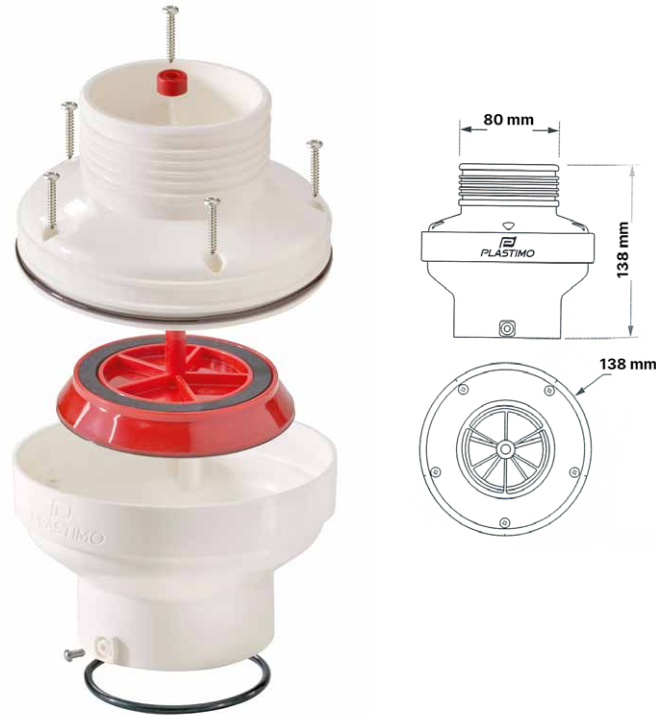

PLASTIMO

30TH
DAME
NOMINATED
2021



EZ AIR COMPACT VENTING SYSTEM

Ref. 67800

Developed by our in-house R&D department in collaboration with the most prestigious European manufacturers, the EZ Air box completes the EZ Water and EZ Elec ranges in terms of ventilation inside the engine hold. The same ingenious EZ fastening system, but with a host of additional innovations. A compact system that facilitates installation, and considerably reduces the size of engine chocks.

Forget goosenecks, the EZ Air system replaces all that cumbersome installation for increased safety. The compartments remain watertight even in the event of capsizing.

Fitted as required with a straight or angled sleeve combined with the various EZ Air options available.

Features:

- Watertight thanks to non-return valve.
- Increases the supply of fresh air to the motors while limiting pressure losses.
- Compact, reduces installation space.
- Outlet for Ø 80 mm ventilation duct. Connection with nut for external spiral duct 67912 or clamps.
- Wave, splash and immersion-proof valve. Joint: max. operating temperature = 100° C.

OEM benefits:

- Ease of ventilation placement.
- Cockpit architecture simplified by allowing free placement.
- Optimized space saving to reduce flood height.
- Limited impact on ISO stability criteria (lateralization on the transom).
- Simplified implementation with true assembly repeatability.

Applications:

- Engine and fuel tank compartments.
- Compartments requiring a condensation prevention system.

Sleeve:

The sleeve must be combined with the EZ Air system to form the complete functional EZ Air housing.

The sleeve can be used independently of the EZ Air system for other applications.

The external spiral sleeve is attached using the Plastimo nut.

Fixing:

- Through bulkhead with elbow sleeve 67910. Bulkhead thickness 25 mm max.
- On casing with straight sleeve 67307.

Mounting:

The system must be mounted vertically (+ or - 10°)

Conformity:

- ISO12216: deck panel sealing in Zone 1 (\$4.41).
- IMCI (International Marine Certification Institute).



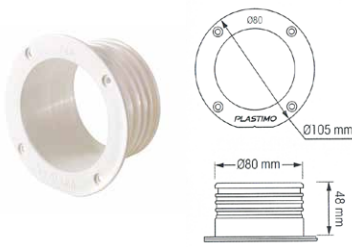

Ø 80 MM STRAIGHT CONNECTOR

Ref. 67307

Allows attachment to a ship's ventilation box. Suitable for Ø 80 mm nut for external spiral duct. Fixed internally or externally with 4 screws. Suitable for optional round and square grilles.

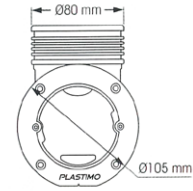
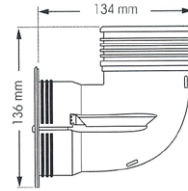

Ø 80 MM ELBOW CONNECTOR

Ref. 67910

The angled sleeve is fastened through the partition using 2 mounting wedges (A4 stainless steel Torx screws supplied). Maximum partition thickness 25 mm. Can also be fixed to an internal ventilation box using 4 screws (not supplied). Passages for hose clamps: the sleeve can be used independently of the EZ Air system. In this case, a gooseneck with hose clamps is fitted. Suitable for Ø 80 mm nut for external spiral duct. Fixed through bulkhead (20 mm max.) by 2 EZ Fit rising wedges supplied, or internally fixed to box by 4 screws. Holes for hose clamps. Suitable for optional round and square grilles.

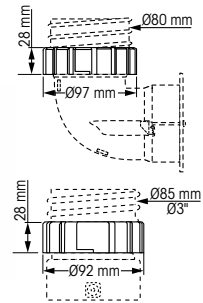

NUT FOR EXTERNAL SPIRAL DUCT

The Plastimo nut is specifically designed for fastening air ducts with external spiral. The nuts clip onto products in the EZ Air range with numerous advantages: Clean assembly. Quick duct attachment. Preservation of sleeve and liner. No need for sealant.

Ref.	Diameter
67913	75 mm
67912	80 mm

Accessories for classic blower

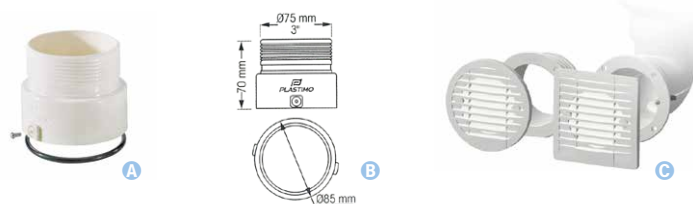

Ref.	Description
A B 67914	Reducer adapted to the straight and elbow connector for the use of a Ø 3" / 75 mm hose. Stainless steel nail x 2. O-ring seal.
C 67872	Round hose vents to stylishly match any deck or transom design for a clean look. Anti-UV ABS.
C 67873	Square hose vents to stylishly match any deck or transom design for a clean look. Anti-UV ABS.

SHEATH WITH EXTERNAL SPIRAL

Flexible PVC sheath reinforced with a rigid PVC spiral of anti-shock quality.
Smooth inner wall.
Using temperature: -10° C to +60° C.
Do not use under pressure.
Lightweight and resistant.
Length: 25 m.



Ref.	Inner diameter	Thickness	Weight	Bending radius	Negative pressure
403945	70 mm	0,6 mm	415 g/m	105 mm	150 mbar
403944	75 mm	0,6 mm	465 g/m	113 mm	140 mbar
70567	80 mm	0,6 mm	510 g/m	120 mm	140 mbar
418253	100 mm	0,8 mm	615 g/m	150 mm	140 mbar

SHEATH WITH INTERNAL SPIRAL

Flexible PVC sheath reinforced by a PVC spiral embedded in the wall.
Smooth inner wall.
Temperature range: -15° C to +60° C.
Do not use under pressure.
Very flexible.
Length: 25 m.



Ref.	Inner Diameter	Thickness	Weight	Bending radius	Negative Pressure
16277	70 mm	0,5 mm	500 g/m	110 mm	150 mbar
27160	76 mm	0,5 mm	530 g/m	115 mm	127 mbar
27161	102 mm	0,5 mm	1000 g/m	127 mm	100 mbar

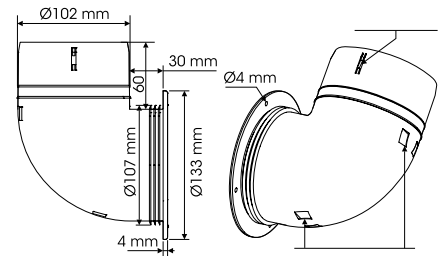
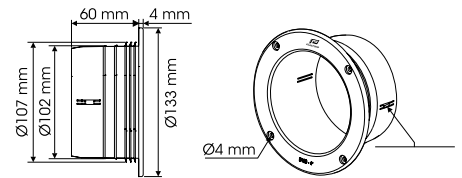

WALL-MOUNT PVC CONNECTOR

Ref.	Description
50155	Straight Plastic Wall Bracket For Hose Ø : 65 - 70 mm
50156	Straight Plastic Wall Bracket For Hose Ø : 100 mm

SLEEVES FOR VENTILATION DUCTS

Specifically designed for engine hold ventilation.
Made from polypropylene, the sleeves are resistant to hydrocarbons and acetic acids, as well as impact and stress. Notches and claws hold the hose in position.

	Ref.	Description
A	51069	Bent sleeve
B	51070	Right sleeve

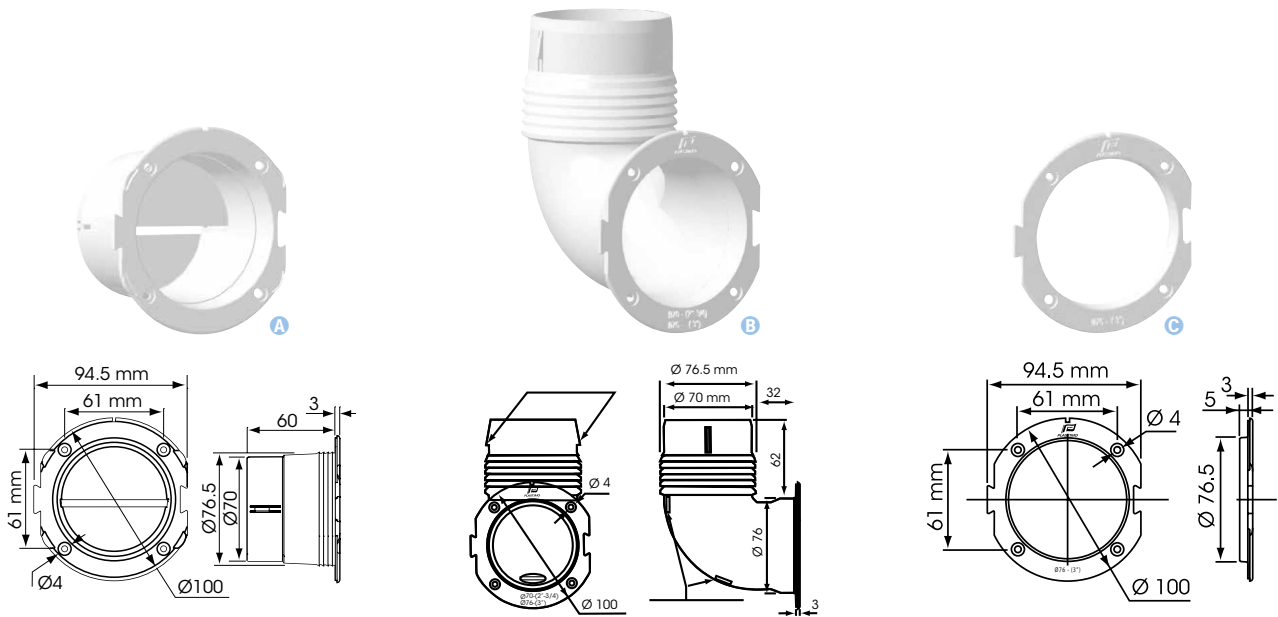

STIFF DUCTING ADAPTERS

Sleeves for 3" and 70 mm outlets. Made of polypropylene for good UV resistance. Shock-resistant, strain-resistant, compatible with common sealants and insensitive to acetic acids. Designed to hold a ventilation duct to a bulkhead. The straight sleeve features a baffle to ensure ventilation while preventing the intrusion of sea water. Quick, easy installation: drill a $\varnothing 76$ mm hole with a hole saw. Notches hold the support in the wall. Fix the sleeve to the wall with 4 M4 screws and sealant (suitable for all types of sealant). Clip on a grating if required: the clips are grooved to hold the grating in place. Install the pipe on the sleeve. Two claws hold the pipe in place before securing it with two stainless steel clamps (not supplied).

	Ref.	Model
A	47514	Straight sleeve
B	54389	Elbow sleeve
C	54390	Collar



ROUND GRIDS + FLANGE

Grilles with sleeves made of PBT, for good UV resistance. Compatible with common sealants and insensitive to acetic acids. Insensitive to variations in humidity.

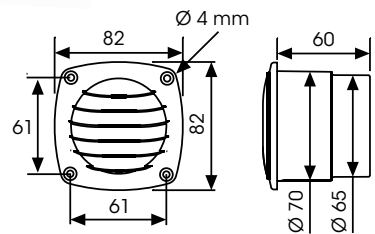

VENTILATION FLANGE

Ref. 417965

Moisture- and hydrocarbon-resistant black polyethylene \varnothing ext. 85 mm. Fastening of $\varnothing 75$ mm pipe without hose clamp. Quick assembly from above deck.

	Ref.	Color	Dimensions
A	12410	White	$\varnothing 65/70 - 82 \times 82$ (with sleeve)
	16310	Black	$\varnothing 65/70 - 82 \times 82$ (with sleeve)
B	421955	White	$\varnothing 100 - 125 \times 125$
	421956	Black	$\varnothing 100 - 125 \times 125$

SELECTED BY PLASTIMO**FIXED MOTOR BRACKET**

Ref. 405066

Right table (0° to 17°). Stainless steel console, L. 178 mm.
 Varnished wooden table adjustable in 3 positions.
 Transom mount.
 For 8 HP engine - 40 kg max.
 Height: 150 mm.
 Width: 265 mm.
 Thickness: 35 mm.

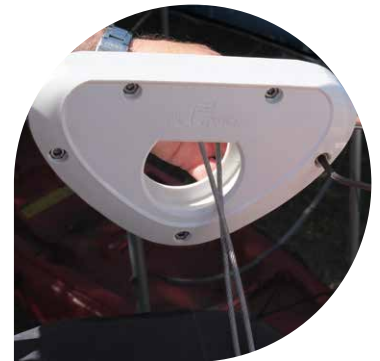
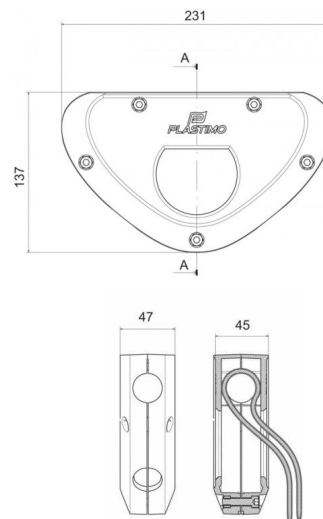

**OUTBOARD MOTOR HOLDER**

Fixed motor mount, with cable storage compartment.
 Glass-filled polyamide 6 and stainless steel screws.
 Mounted on Ø 25 mm stainless steel tube.
 Delivered with 90 cm sheathed stainless steel cable (Ø 4.2 mm).
 Dimensions: 231 x 137 x 47mm (W x H x D)
 For max. 5 HP motor (max. load 30 kg).

Ref.	Color
61535	White
65628	Grey



PROTECTIVE COVERS

- Protection for weather, sun and salt.
- Designed with tough materials: 100% polyester 150D to 300D.
- Waterproof: water-repellent fabric.
- Storage bag and fasteners included.
- Do not use for transport.

	Ref.	Boat length	Boat beam	Material
A	P202587	3,5 m	2,8 m	150-denier polyester
	P202564	3-3,85 m	1,6 m	150-denier polyester
	P202565	4,25-4,90 m	1,8 m	150-denier polyester
	P202566	4,25-4,90 m	2,4 m	150-denier polyester
B	P202567	4,90-5,55 m	2,4 m	150-denier polyester
	P202568	5,20-5,80 m	2,45 m	150-denier polyester
	P202569	5,80-6,50 m	2,9 m	150-denier polyester
	P202570	6,30-7,10 m	3,8 m	150-denier polyester
	P202571	7,10-8,30 m	4,5 m	150-denier polyester
	P202572	3-3,85 m	1,6 m	300 denier polyester
	P202573	4,25-4,90 m	1,8 m	300 denier polyester
C	P202574	4,25-4,90 m	2,4 m	300 denier polyester
	P202575	4,90-5,55 m	2,4 m	300 denier polyester
	P202576	5,20-5,80 m	2,45 m	300 denier polyester
	P202577	5,80-6,50 m	2,9 m	300 denier polyester
	P202578	6,30-7,10 m	3,8 m	300 denier polyester
	P202579	7,10-8,30 m	4,5 m	300 denier polyester

OUTBOARD MOTOR COVERS

- Protection for weather, sun and salt.
- Available in 8 sizes for engines from 20 to 300 hp.
- High strength: 100% polyester.
- Color: grey.
- Storage bag and fasteners included.
- Do not use for transport.

Ref.	Motor	Height	Width	Length
P202580	2-5 cv	32 cm	25 cm	40 cm
P202581	2-15 cv	35 cm	27 cm	48 cm
P202582	10-45 cv	45 cm	33 cm	55 cm
P202583	30-90 cv	50 cm	35 cm	63 cm
P202584	70-150 cv	65 cm	40 cm	73 cm
P202585	115-225 cv	75 cm	45 cm	75 cm
P202586	150-300 cv	80 cm	60 cm	90 cm



A

Adapters.....	139, 145, 249
Adhesive reflecting tape.....	58
Advancea range.....	187-190
Airmar speed sensor.....	191
Air sleeves.....	210
AIS.....	192
Anchor ball.....	55
Anchor - Britany.....	128
Anchor - DC.....	130
Anchor - FHD Galva.....	131
Anchor - Flat.....	132
Anchor - Grip.....	128
Anchor - Kobra.....	130
Anchor - Soc.....	132
Anemometer.....	189, 193
Angle dock fender.....	144
Anti-seasickness wrist band.....	62
ARC fender.....	140
Articulated RIB fender.....	140
Articulation for ladder.....	154
Austral 180N Inflatable lifejacket SOLAS.....	30
Automatic flashlight.....	33, 65

B

Back supporters.....	218
Bag for halyards.....	218
Bag with safety equipment.....	41, 67
Bag for tenders.....	116
Bailer.....	60
Barometer.....	203, 204
Bezel.....	183
Binnacles.....	183
Binoculars.....	200, 202
Blanket.....	65
Block kit.....	224
Blower.....	244
Blue python stretch water hose.....	94
Boarding ladder.....	150-154
Boat covers.....	258
Bollard.....	134
Bosuns chair.....	42
Bow shields.....	133
Brackets.....	184
Britany anchor.....	128
Britany package.....	135

British dividers.....	199
Bucket.....	60
Bumper.....	145, 146
Buoyancy aid.....	39-42
Buoyant cushion.....	54
Buoyant smoke DNS.....	68
Buoy for regatta training.....	148
Bypass for pump 925 and 1038.....	91

C

Cable cutter.....	58
Canadian paddles.....	122
Cargo boom.....	121
Clock.....	203, 204
Coastal Liferaft.....	80
Code of maritime signals (french).....	205
Compasses.....	162-184
Compass mini-contest advancea.....	170
Compasses for boat builders.....	184
Connector.....	247
Container for ring buoy.....	51
Contest® 130.....	173
Contest® 101.....	172
Cool'n Dry dorade box.....	209
Covers.....	258
Cradle (liferaft).....	85
Cras plotter.....	199
Cruiser Liferaft.....	81
Crutch strap for inflatable lifejacket.....	32
Customize your iris 50.....	182
Cut-off key.....	239
Cutter.....	58

D

Dan buoy.....	52, 53
Davits.....	121
DC anchor.....	130
Deck hatch.....	233
Deck safety harness.....	43
Deck shower EZ Water.....	95
Deck-mount cradle with straps.....	85
Depth S400 sounder.....	187
Diaphragm pump.....	89
Dock fender.....	144
Dock protections.....	144
Docking pole.....	146

Dockwheel.....	144
Dog flotation vest.....	41
Dorade box.....	209, 210
Doris compass.....	179
Double blade safety knife.....	32
Double braided polyester.....	136
Drogue (sea anchor).....	61
Drum.....	222
Dye marker.....	58

E

Echotest II depth sounder.....	190
Electric diaphragm pump, for bilge, livewell and waste waters.....	88
EVO 165 inflatable lifejacket.....	23
EVO-J Junior inflatable lifejacket.....	23
Evolution cras plotter.....	199
Eye bolt Polished AISI 316 stainless steel.....	229
Eye nut & eye bolt.....	227
Eye strap.....	229
EZ Air venting system.....	246
EZ Water.....	95-96

F

Fastenings (ladder).....	154
Faucet.....	98
Fender.....	139-142
Fender basket.....	144
Fender for large yachts.....	139
Fender sock.....	143
FHD anchor.....	131
First aid kits.....	62, 63
Fish tender.....	115
Fittings for freshwater tanks.....	92
Fittings for Plastimo manual bilge pump.....	91
Fixing kits for ring buoy container.....	51
Flag code adhesive.....	205
Flange.....	210, 249
Flashlight.....	33, 56, 57, 65
Flat anchor.....	132
Flat fender.....	142
Flexible water tank fresh water.....	93
Floating pine hook.....	124
Floating safety knife.....	59
Fog horn.....	55

Fresh water in vacuum sachet.....	64
Fresh water inlet.....	96
Fuel tank.....	239, 240
Fuel tank accessories.....	242
Fun tender.....	106
Funnels.....	242
Fixed VHF.....	197

G

Galva.....	31
Grab bag.....	66
Grapnel.....	133
Grid.....	249
Grip anchor.....	128
Grip package.....	135
Guardrail netting.....	218

H

Half halyard feeder.....	221
Halyard diverter/feeder/swivel.....	221
Halyard stowage bags.....	218
Hammar hydrostatic release unit for liferafts.....	84
Handflare DNS.....	68
Hand lead line.....	59
Hand pump.....	60
Handrail holder.....	230
Harness.....	43
Harness for outboard engine.....	121
Hatches.....	233-235
Headlights LED.....	215
Heelmeters.....	202
Holder for fenders.....	144
Holder for hand dividers.....	199
Holder for outboard motor.....	102
Holder for pulpit mounting.....	47
Hook.....	124
Horizon tender.....	103
Horn.....	55
Horseshoe buoy.....	48, 49
Hose.....	94-95
Hygrometer.....	203-204

I

Inflatable horseshoe buoy.....	48
Inflatable IOR dan buoy.....	52

Inflatable lifejacket Seapack 150.....	26
Inlet (water).....	96
Inlet water strainer.....	88
Insulating blanket.....	65
Iris 100.....	181
Iris 50.....	182

J

Jackline.....	46
Jerrycan.....	92, 240
Jib reefing.....	220
Jib reefing accessories.....	221, 222
Jib reefing spar kit.....	224
Jockey console.....	109
Jumbo regatta mark buoy.....	148

K

Kayak compass.....	180
Kayak paddles.....	123
Kid'o lifejacket.....	39
Kill cord for outboard engine.....	239
Knife.....	59
Kobra anchor.....	130, 135

L

Ladder.....	61, 150-154
Ladder accessories.....	154-155
Ladder steps.....	154
Lead line.....	59
Leather spreader boots.....	223
LED floating safety flashlight.....	56
LED torch.....	214
Lifebuoy steady light.....	56
Lifeguard Rescue buoy.....	54
Lifeline protection.....	218
Lifeline sleeve.....	218
Liferafts.....	78-83
Liferaft cradle.....	85
Liferaft servicing.....	86
Light alloy hook.....	124
Lightstick.....	33
Loch-speedo S400.....	188
Locking kit.....	235
Loud hailer.....	202

M

Manual bilge pump.....	90
Manual pumps.....	89
Marine Binoculars.....	200
Marine code adhesive.....	205
Microphone for VHF.....	195
Mini code regatta adhesive.....	205
Mini-B Olympic.....	179
Mini-C.....	179
Mini-Contest®.....	170
Mixer tap.....	95
Mob buoy.....	47
Monocular.....	200
Mooring lines.....	136, 137
Mooring package.....	135
Motor bracket.....	250
Motor covers.....	251
Motor holder.....	102, 150
Motoring cone.....	55
Mounting bracket.....	224
Multi S400 Log-speedo/Depth.....	188
Multi-tool.....	59
Mushroom anchor.....	133

N

Naudet barograph mahogany.....	204
Navigation protractor.....	199
Neo 165 inflatable lifejacket.....	24
Neo Pro 165 inflatable lifejacket.....	28
Neo-J inflatable lifejacket.....	23
Net.....	218
Nut for external spiral duct.....	247

O

Oars.....	123
Octoplat.....	136
Odeo Flare MK4 LED emergency signal.....	68
Offshore® 105 & 135 mounting bracket.....	169
Offshore® 105.....	167
Offshore® 115.....	168
Offshore® 135.....	169
Offshore® 55 - Kayak version.....	180
Offshore® 55.....	162
Offshore® 75.....	163-164
Offshore® 95.....	165

Olympic® 115.....	175
Olympic® 135.....	176
Olympic® 135 Open.....	177
Olympic® 95 & 100.....	174
Outboard motor holder.....	102, 250
Outlet (water).....	96

P

Pad.....	230
Paddles.....	122-123
Pad-eye.....	226
Padlock.....	236
Parachute rocket.....	68
Patch.....	230
Pelican Hook.....	218
Performance fender.....	139
Pilot 165 inflatable lifejacket.....	22
Pilot 180 inflatable lifejacket.....	25
Pilot 300 inflatable lifejacket.....	25
Pilot Pocket inflatable lifejacket.....	26
Pilot Pro 180 inflatable lifejacket.....	28
Pilot Pro 300 inflatable lifejacket.....	29
Pin.....	223
Plasticlip for compass.....	184
Plasticlip holder.....	56, 125, 231
Platform ladder.....	151, 153
Poles for ring buoy container.....	51
Porthole barometer.....	203
Porthole clock.....	203
Porthole thermometer hygrometer.....	203
Portlight.....	232
Pouch for lifejacket.....	32, 42
Pro 165 inflatable lifejacket.....	29
Protective cover for compasses.....	18
Protractor.....	199

R

Raid tender.....	104-105
Rail mounting kit.....	48
Rack (for ring buoy).....	50
Red handflare DNS.....	68
Red parachute rocket DNS.....	68
Regatta mark buoys.....	147
Rescue Belt.....	26
Rescue Buoy®.....	48
Rescue Line®.....	47

Rescue Ring SOLAS lifebuoy®.....	50
Rescue Sling®.....	47
Ring buoy.....	51
Ring buoy container.....	51
Ring buoy container accessories.....	51
Rings.....	223
Rockfish grapnel.....	133
Rope kit.....	224
Round U-bolt.....	225
Rubber bucket.....	60
Rubber dock fender.....	144
Rubbing strakes.....	230

S

S400.....	187, 190
Safetics - Navigator check-list.....	205
Safety bag.....	41, 67
Safety flashlight.....	57
Safety harness.....	43
Safety knife.....	32, 59
Safety ladder.....	61
Safety sprayhood.....	32
Sailmon Max.....	186
Screw kit for jib reefing.....	222
Sea anchor.....	61
Seapack 150 inflatable lifejacket.....	26
Sea or fresh water outlet.....	96
Seasickness.....	62
Sensor.....	191
Sheath.....	248
Ship bell.....	55
Signal kit.....	68
Signaling mirror.....	32
Silence water pumps.....	88
Silzig MOB buoy.....	47
Sleeves for ventilation ducts.....	248
Snaplight lightstick.....	33
Soc anchor.....	132
SOLAS foam lifejacket.....	42
SOLAS inflatable lifejacket.....	30, 31
SOLAS insulated immersion suit.....	65
SOLAS insulating thermal suit.....	65
SOLAS lifebuoy.....	50
Spar kit for jib reefing.....	224
Spare cowl.....	208
Spare hook.....	125
Spare parts for handheld VHF radios.....	195

Spare parts for pumps.....	91
Spare valve (fenders).....	139, 145
Speed sensor.....	191
Spotlight.....	212
Sprayhood.....	32
Spreader boots.....	223
Stanchion guard.....	218
Stand-offs (ladders).....	154
Storm buoyancy aid.....	41
Storm jib.....	58
Storm lifejackets.....	40, 41
Strainer for inlet water.....	88
Survival food rations.....	64
Switch (pump).....	88
SX-350+ handheld VHF.....	194
SX-400+ Handheld VHF.....	195

T

Tactical compass.....	178
Tank.....	93, 239-240
Tank accessories.....	242
Tap.....	98
Tape.....	58
Telescopic ladder.....	150, 152, 153
Tender.....	102-115
Tender accessories.....	117
Tether.....	44, 45
Thermomether hygrometer.....	203
Through-hull.....	191
Throwing line for buoy.....	50
Torch.....	212-214
Torch light.....	213
Trail tender.....	107
Transocean ISO Liferaft.....	78, 79, 82, 83
Transom pintles.....	228
Trump and Mini-Trump.....	55
Tube.....	230
Typhoon lifejacket.....	40, 42

U

U-bolt.....	225-226
UML manual re-arming kit.....	48

V

Valve.....	91, 242
------------	---------

Ventilation flange.....	249
Ventilation shut-off unit.....	210
Vents.....	208, 210, 243
VHF.....	194-197

W

Water hose.....	94
Water pump.....	88
Water Strainer.....	88
Watertight U-bolt.....	225
Weatherman.....	204
Wheels for pneumatic boats.....	116
Whistle.....	32, 55
White handflare DNS.....	68
Winch handle pockets.....	231
Wind indicators.....	224
WIND S400.....	189
Wind sensor.....	186
Windsocks.....	210
WIND-A S400.....	189
Windy handheld anemometer.....	193
Wooden plugs.....	60
Work light.....	214

X

X-Spot buoyant spotlight.....	212
-------------------------------	-----

LEGAL NOTICES

All products manufactured by Plastimo, which must comply with a standard of buoyancy, resistance, inflation time... are declared up to standard when they leave our factory. These products are designed and produced for normal conditions of use.

Use of goods : Information and general advice given in this catalogue are for indicative purposes only and strictly apply to the use of our products in a recreational boating environment. It is the customer's responsibility to determine a product's suitability for his intended application. Plastimo hereby gives notice that it will not accept responsibility for any damages or loss directly or indirectly arising as a result of the inappropriate use of its products.

Plastimo reserves the right to modify any of its products in order to comply with a new standard or regulation.

Misprints excepted, this catalogue (and all accompanying leaflets) are intended to give a general description only. Illustrations, sizes and descriptions are generally accurate, but shall not be considered binding or part of a contract. Plastimo reserves the right to alter technical specifications, etc. without notice. Colours shown in our catalogue are as accurate as printing variations permit ; they may vary slightly from the actual product.

CONDITIONS OF SALE

Plastimo sells only to chandlers, boat builders and bona fide retailers in the marine trade. Plastimo products are available to the general

public through this network of retailers. Please visit www.plastimo.com to obtain the name/address of your nearest dealer.

WARNING

Plastimo (Lorient-France) has paid the copyrights related to all the photographs printed in this catalogue. Any reproduction of these photos - whatever the media - is strictly forbidden without the authorisation from Plastimo and the photographer.

Jean-Marie LIOT, Matteo ULISSE, Guillaume GATEFAIT, ALEA, Disobey- MACIF, Polaryse - Julien Champolion, Graham Snook, Thibaut Desplats, B. Leglatin, Jean Baptiste d'Enquin, J. Kelagopian, Clément Le Calvé





PLASTIMO AROUND THE WORLD

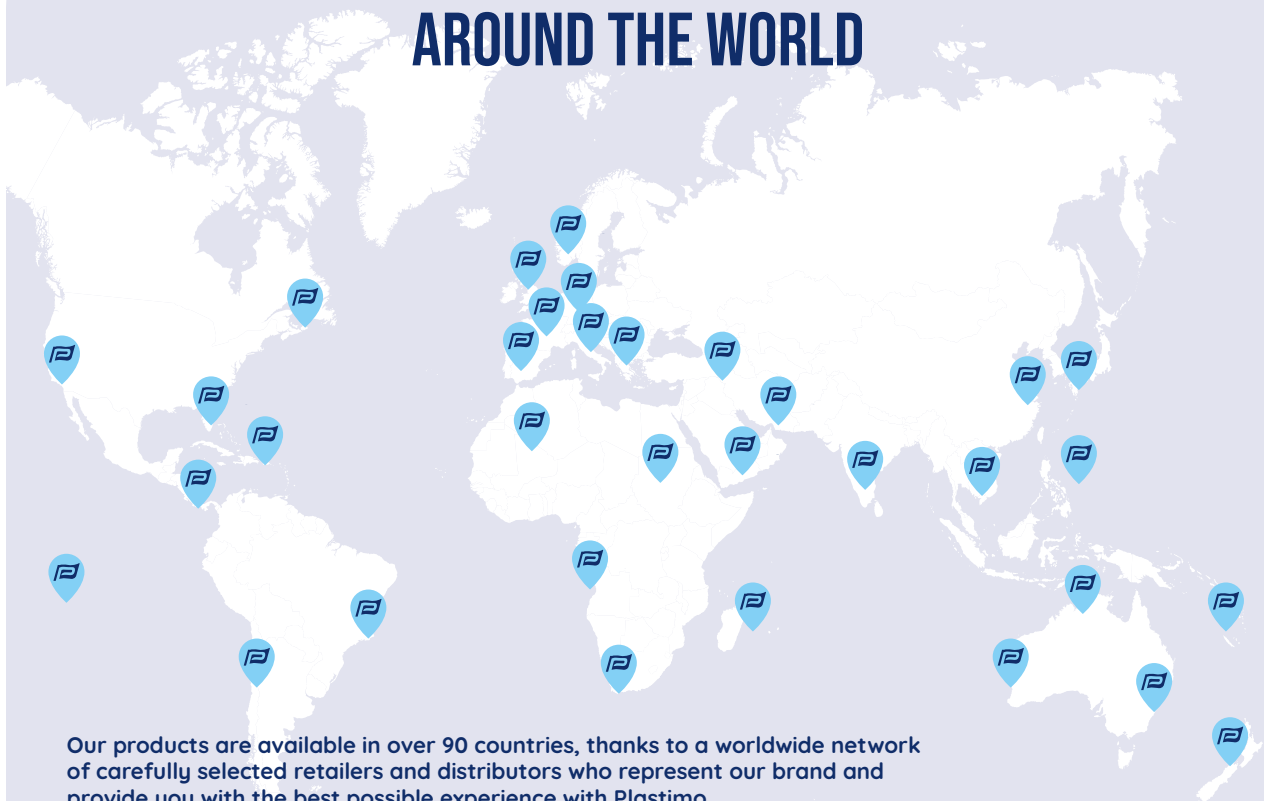

Our products are available in over 90 countries, thanks to a worldwide network of carefully selected retailers and distributors who represent our brand and provide you with the best possible experience with Plastimo.

Would you like to join the adventure and become part of our network?
Contact us at: exportsales@plastimo.com

Plastimo is an international company : nearly 50% of its business is conducted abroad, thanks to a network of reputable subsidiaries in countries with a strong maritime tradition. Whether you are sailing along the French coast or on any of the world's seas, you can count on quick and easy access to Plastimo's services, provided by professionals: ship chandlers and retailers in France, international importers and service stations (for liferafts and lifejackets) located around the world.

PLASTIMO FRANCE

Head office - Production -
Logistics - Servicing station
(liferafts, lifejackets, IOR poles) -
Click and Collect

21 rue Amiral Dordelin
56100 LORIENT
contact@plastimo.com -
02.97.87.36.36

PLASTIMO GROUP

GERMANY

Bukh Bremen GMBH
Ferdinand-Porsche-Straße 11,
28237 Bremen

SWEDEN

Navinordic AB
Lundenvägen 2,
473 31 Henån

SPAIN

Dismarina Mediterranea
Carrer Pep Ventura, 12,
08440 Cardedeu, Barcelona

ITALY

Forniture Nautiche Italiane
Per la Val di Cecina, 66,
57023 Cecina LI

UNITED-KINGDOM

Marathon Leisure
Northney Rd,
Hayling Island PO11 0NH,
Royaume-Uni

Scan the QR code
to check out
our points of sale and
servicing stations





PLASTIMO



PLASTIMO GROUP
21 RUE AMIRAL DORDELIN
56100 LORIENT

Tél. +33 (0)2 97 87 36 36
www.plastimo.com

